

USER MANUAL

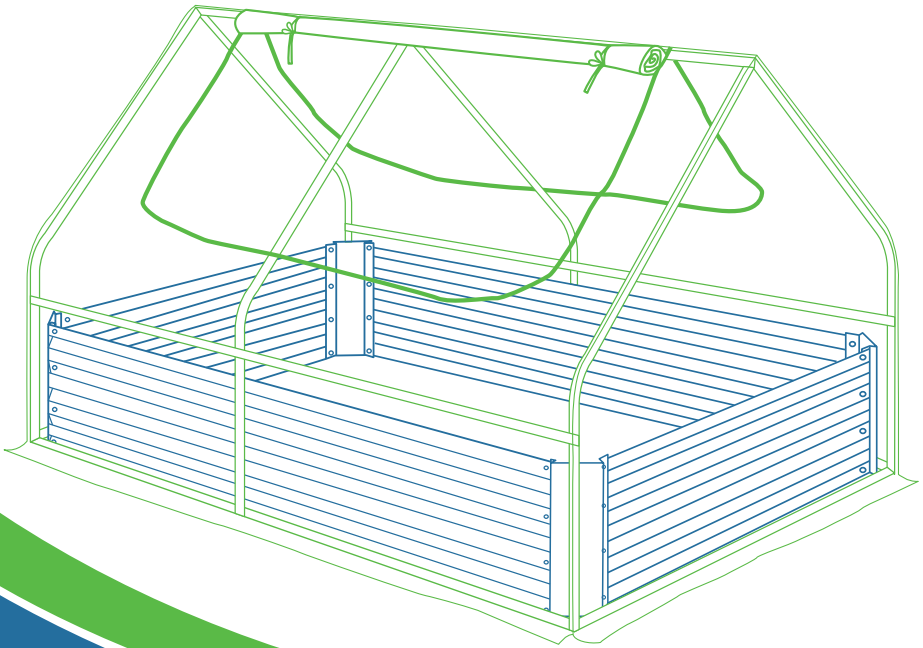

Please read, understand, and practice the guidelines in this user manual before use, and keep it for future reference.

49" x 37.4" x 36"
47" x 35.4" x 12"
71" x 35.4" x 12"
96" x 48" x 11.8"

72.8" x 37.4" x 36"
47" x 35.4" x 22.4"
71" x 35.4" x 22.4"
96" x 48" x 22.4"

Table of Contents

- About Quiccent 5
- 49" x 37.4" x 36" 6
- 72.8" x 37.4" x 36" 9
- 47" x 35.4" x 12" 12
- 47" x 35.4" x 22.4" 14
- 71" x 35.4" x 12" 16
- 71" x 35.4" x 22.4" 18
- 96" x 48" x 11.8" 20
- 96" x 48" x 22.4" 22
- Maintenance 24
- Warranty 24

IMPORTANT

We'd love to hear from our customers. If you have any questions about the manual, would like us to help in any way, or have any suggestions and comments about our products, please feel free to contact the support team. We will reply in 12 hours (business days).

Garden Beds from Quiccent



49" x 37.4" x 36" GB-01



49" x 37.4" x 36" GB-02



72.8" x 37.4" x 36" GB-51



72.8" x 37.4" x 36" GB-51G



47" x 35.4" x 12" GB-03S



47" x 35.4" x 22.4" GB-03H



71" x 35.4" x 12" GB-04S



71" x 35.4" x 22.4" GB-04H

This user manual applies to Quiccent Galvanized Raised Garden Beds. It will help you to get to know your Quiccent raised garden bed. Please read the guidelines in this manual and keep the manual for future reference.

We may update the manual without notice in advance. You can always search **“Quiccent Instructions”** online for the latest version.

About Quiccent

Founded in the early 21st century, Quiccent has grown into a popular brand with reliable products and excellent customer services during the past decades. We started with pop up canopies, and then expanded to other 6 categories for shelters and the like including party tents, carports, greenhouses, shade sails, patio umbrellas and grow tents. Driven by the vision to create unique spaces to meet every specific need and become a part of America's landscape, we at Quiccent would spare no effort to keep innovating.

Our Vision

Creating unique spaces to meet every specific need, and become a part of America's landscape.

Our Mission

To keep innovating and provide a wide range of reliable shelters and shades at consumer-grade prices with customer-first service.

Our Service

The customer-centric services are what we at Quiccent take great pride in. In addition to the hassle-free warranty covering all Quiccent products, an industrial-leading support team is standing behind at all times. Whenever you need help or have any suggestions and comments about our products or services, do not hesitate to contact the Quiccent support team. We'll get back as soon as possible and you're sure to get a to-the-point reply in 12 hours (business days).

49" x 37.4" x 36"

You'll receive only one (1) box. Please make sure all parts are numbered and graphically indexed as shown, so does the quantity for each part upon arrival. If you need any help, please **CONTACT the support team** with the **order number, required parts, quantity for each part, and photos** (or videos, if applicable), we will get back to help out soon.









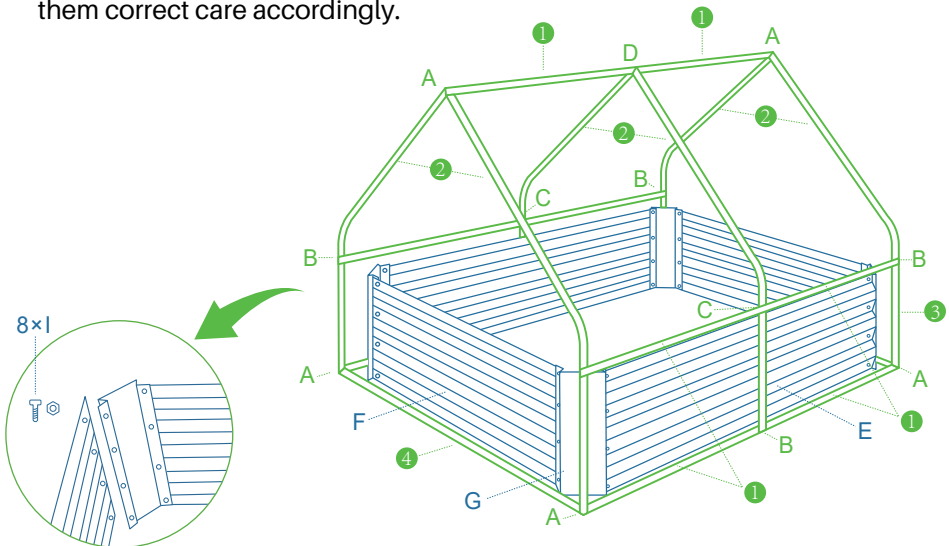

Parts List





There are two models for this size: Model #GB-01 & Model #GB-02. The two models are the same except for the cover (#5) in the parts list below. A model (#GB-01) comes with a green cover while the model (#GB-02) has a clear cover.

Reminders!

- The parts from **#1 - #D** in the parts list below are **for the greenhouse**.
- The parts from **#E - #I** in the parts list below are **for the garden bed**.
- Please always wear the gloves (**#J**) in assembly.
- The T-Type Plant Tags (**#K**) are gifts so that you can label your plants and give them correct care accordingly.



Part Number	Diagram	Description	Quantity (PCS)
#1		Pole (23.2")	10
#2		Pole with Curved End	6
#3		Pole (11.8")	6
#4		Pole (35.4")	2
#5		1 * Green Cover for GB-01 1 * Clear Cover for GB-02	1
#A		90-Degree 3-Way Connector	6
#B		T-Shaped 3-Way Connector	6
#C		X-Shaped 4-Way Connector	2
#D		4-Way Connector	1
#E		Long Metal Sheet	2
#F		Short Metal Sheet	2

Part Number	Diagram	Description	Quantity (PCS)
#G		Corner Sheet	4
#I		Bolt	32 Bolts & 32 Nuts
#J		Glove	2 (1 Pair)
#K		T-Type Plant Tag	20

Assembly

- Step 1.** Layout all the Long Metal Sheets (#E) and all the Short Metal Sheets (#F).
- Step 2.** Connect each sheet with a Corner Sheet (#G) and several Bolts (#I) until you finish connecting the 4 corners.
- Step 3.** Set up the greenhouse frame with all the poles and connectors (parts from #1 - #K) outside the assembled garden bed.
- Step 4.** Put on the Cover (#5).

72.8" x 37.4" x 36"

You'll receive only one (1) box. Please make sure all parts are numbered and graphically indexed as shown, so does the quantity for each part upon arrival. If you need any help, please **CONTACT the support team** with the **order number, required parts, quantity for each part, and photos** (or videos, if applicable), we will get back to help out soon.









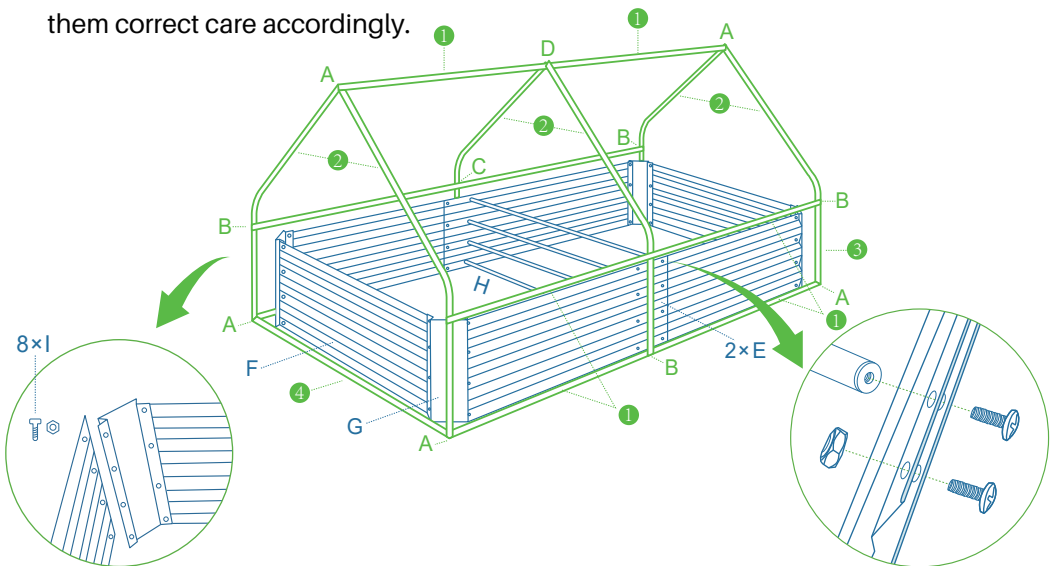

Parts List



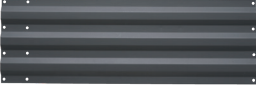

There are two models for this size: Model #GB-51 & Model #GB-51G. The two models are the same except for the cover (#5) in the Parts List. A model (#GB-51) comes with a clear cover while the model (#GB-51G) has a green cover.

Reminders!

- The parts from **#1 - #D** in the parts list below are **for the greenhouse**.
- The parts from **#E - #I** in the parts list below are **for the garden bed**.
- Please always wear the gloves (**#J**) in assembly.
- The T-Type Plant Tags (**#K**) are gifts so that you can label your plants and give them correct care accordingly.



Part Number	Diagram	Description	Quantity (PCS)
#1		Pole (35")	10
#2		Pole with Curved End	6
#3		Pole (11.8")	6
#4		Pole (35.4")	2
#5		A Clear Cover for GB-51 A Green Cover for GB-51G	1
#A		90-Degree 3-Way Connector	6
#B		T-Shaped 3-Way Connector	6
#C		X-Shaped 4-Way Connector	2
#D		4-Way Connector	1
#E		Long Metal Sheet	4
#F		Short Metal Sheet	2

Part Number	Diagram	Description	Quantity (PCS)
#G		Corner Sheet	4
#H		Middle Supporting Pole	4
#I		Bolt	48 Bolts & 40 Nuts
#J		Glove	2 (1 Pair)
#K		T-Type Plant Tag	20

Assembly

- Step 1.** Layout all the Long Metal Sheets (#E) and all the Short Metal Sheets (#F). Please note that when laying out the Long Steel Sheets, you should align the two rows of pre-drilled holes with each other in the middle.
- Step 2.** Connect each sheet with a Corner Sheet (#G) and several Bolts (#I) until you finish connecting the 4 corners.
- Step 3.** Add all the Middle Supporting Poles (#H) to the middle of Long Steel Sheets.
- Step 4.** Set up the greenhouse frame with all the poles and connectors (parts from #1 - #D) outside the assembled garden bed.
- Step 5.** Put on the Cover (#5).





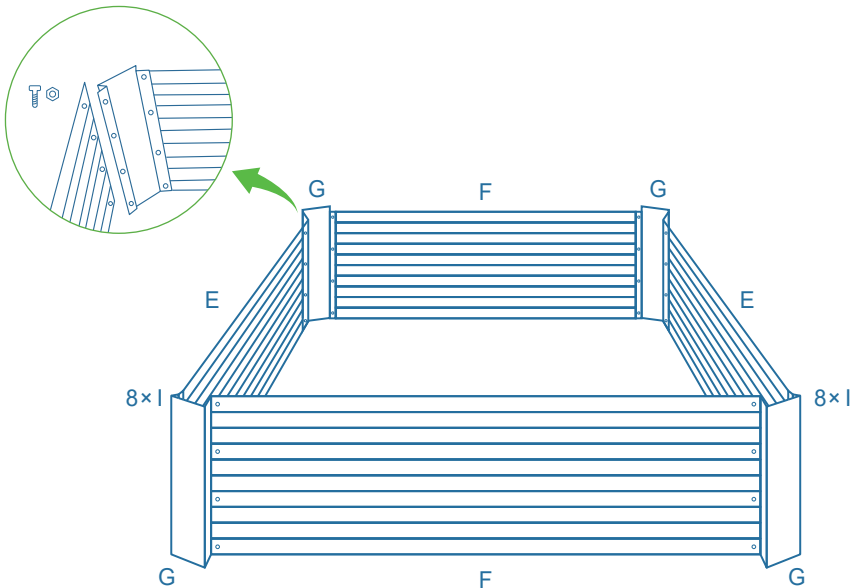

47" x 35.4" x 12"

You'll receive only one (1) box. Please make sure all parts are numbered and graphically indexed as shown, so does the quantity for each part upon arrival. If you need any help, please **CONTACT the support team** with the **order number, required parts, quantity for each part, and photos** (or videos, if applicable), we will get back to help out soon.

Parts List

- Apply to the model #GB-03S.
- Please always wear the gloves (#J) in assembly.
- It's up to you whether to lay the Weed Barrier (#L) before the assembly or not.
- The Plant Support Cage (#M) is the gift for your future gardening. You'll **NOT** use it in assembly.



Part Number	Diagram	Description	Quantity (PCS)
#E		Long Metal Sheet	2
#F		Short Metal Sheet	2
#G		Corner Sheet	4
#I		Bolt	32 Bolts & 32 Nuts
#J		Glove	2 (1 Pair)
#L		Weed Barrier	1
#M		Plant Support Cage	1

Assembly

Step 1. Layout all the Long Metal Sheets (#E) and all the Short Metal Sheets (#F).

Step 2. Connect each sheet with a Corner Sheet (#G) and several Bolts (#I) until you finish connecting the 4 corners.





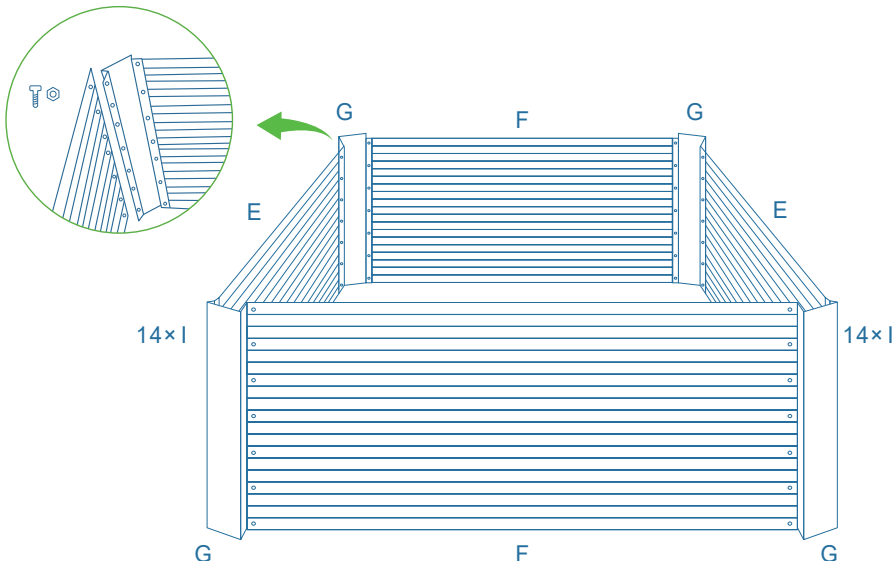

47" x 35.4" x 22.4"

You'll receive only one (1) box. Please make sure all parts are numbered and graphically indexed as shown, so does the quantity for each part upon arrival. If you need any help, please **CONTACT the support team** with the **order number, required parts, quantity for each part, and photos** (or videos, if applicable), we will get back to help out soon.

Parts List

- Apply to the model #GB-03H.
- Please always wear the gloves (#J) in assembly.
- It's up to you whether to lay the Weed Barrier (#L) before the assembly or not.
- The Plant Support Cage (#M) is the gift for your future gardening. You'll **NOT** use it in assembly.



Part Number	Diagram	Description	Quantity (PCS)
#E		Long Metal Sheet	2
#F		Short Metal Sheet	2
#G		Corner Sheet	4
#I		Bolt	56 Bolts & 56 Nuts
#J		Glove	2 (1 Pair)
#L		Weed Barrier	1
#M		Plant Support Cage	1

Assembly

Step 1. Layout all the Long Metal Sheets (#E) and all the Short Metal Sheets (#F).

Step 2. Connect each sheet with a Corner Sheet (#G) and several Bolts (#I) until you finish connecting the 4 corners.







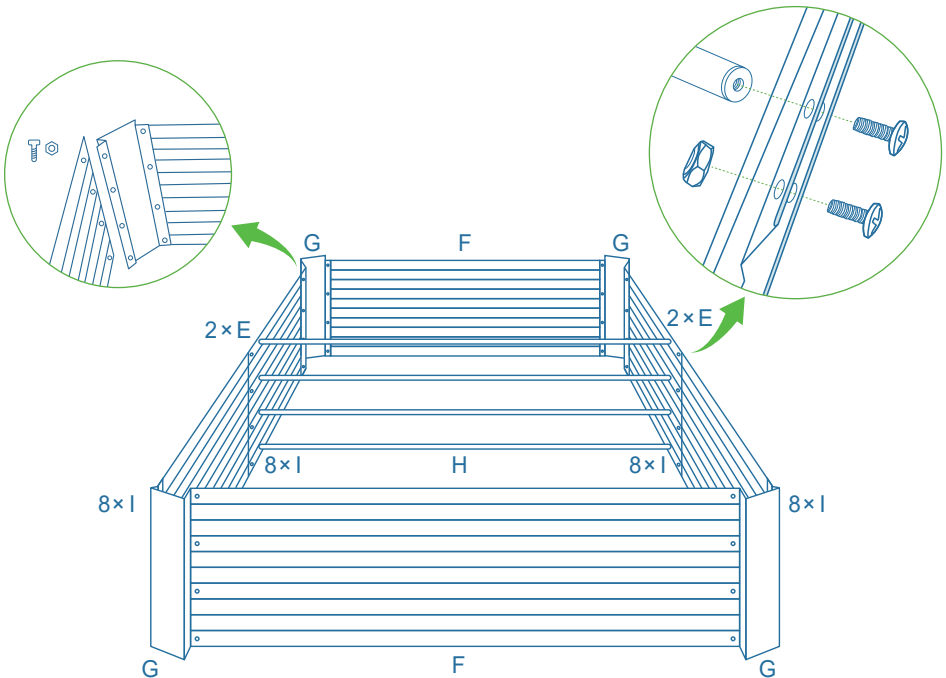

71" x 35.4" x 12"

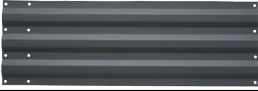
You'll receive only one (1) box. Please make sure all parts are numbered and graphically indexed as shown, so does the quantity for each part upon arrival. If you need any help, please **CONTACT the support team** with the **order number, required parts, quantity for each part, and photos** (or videos, if applicable), we will get back to help out soon.

Parts List

- Apply to the model #GB-04S.
- Please always wear the gloves (#J) in assembly.
- It's up to you whether to lay the Weed Barrier (#L) before the assembly or not.
- The Plant Support Cage (#M) is the gift for your future gardening. You'll **NOT** use it in assembly.



Part Number	Diagram	Description	Quantity (PCS)
#E		Long Metal Sheet	4
#F		Short Metal Sheet	2
#G		Corner Sheet	4
#H		Middle Supporting Pole	4
#I		Bolt	48 Bolts & 40 Nuts
#J		Glove	2 (1 Pair)
#L		Weed Barrier	1
#M		Plant Support Cage	3

Assembly

Step 1. Layout all the Long Metal Sheets (#E) and all the Short Metal Sheets (#F).

Please note that when laying out the Long Steel Sheets, you should align the two rows of pre-drilled holes with each other in the middle.

Step 2. Connect each sheet with a Corner Sheet (#G) and several Bolts (#I) until you finish connecting the 4 corners.

Step 3. Add the Middle Supporting Poles (#H) to the middle of Long Steel Sheets.







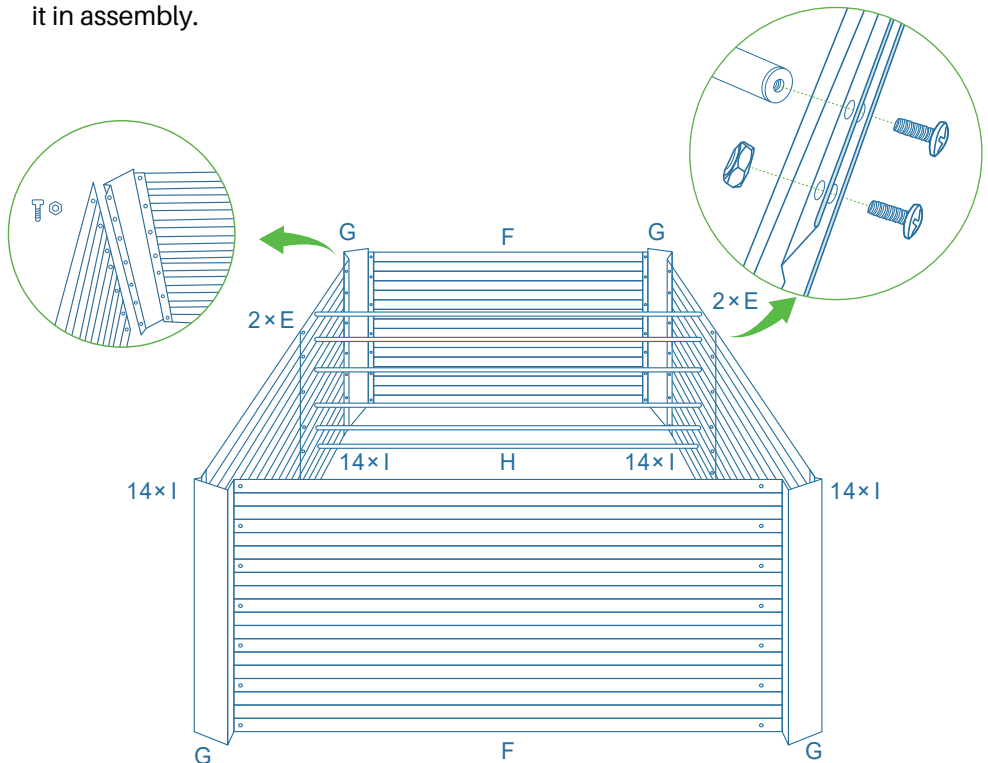

71" x 35.4" x 22.4"

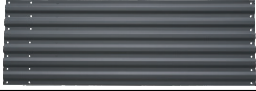
You'll receive only one (1) box. Please make sure all parts are numbered and graphically indexed as shown, so does the quantity for each part upon arrival. If you need any help, please **CONTACT the support team** with the **order number, required parts, quantity for each part, and photos** (or videos, if applicable), we will get back to help out soon.

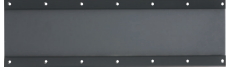
Parts List

- Apply to the model #GB-04H.
- Please always wear the gloves (#J) in assembly.
- It's up to you whether to lay the Weed Barrier (#L) before the assembly or not.
- The Plant Support Cage (#M) is the gift for your future gardening. You'll **NOT** use it in assembly.



Part Number	Diagram	Description	Quantity (PCS)
#E		Long Metal Sheet	4
#F		Short Metal Sheet	2
#G		Corner Sheet	4
#H		Middle Supporting Pole	6
#I		Bolt	84 Bolts & 72 Nuts
#J		Glove	2 (1 Pair)
#L		Weed Barrier	1
#M		Plant Support Cage	3

Assembly

Step 1. Layout all the Long Metal Sheets (#E) and all the Short Metal Sheets (#F).

Please note that when laying out the Long Steel Sheets, you should align the two rows of pre-drilled holes with each other in the middle.

Step 2. Connect each sheet with a Corner Sheet (#G) and several Bolts (#I) until you finish connecting the 4 corners.

Step 3. Add the Middle Supporting Poles (#H) to the middle of Long Steel Sheets.







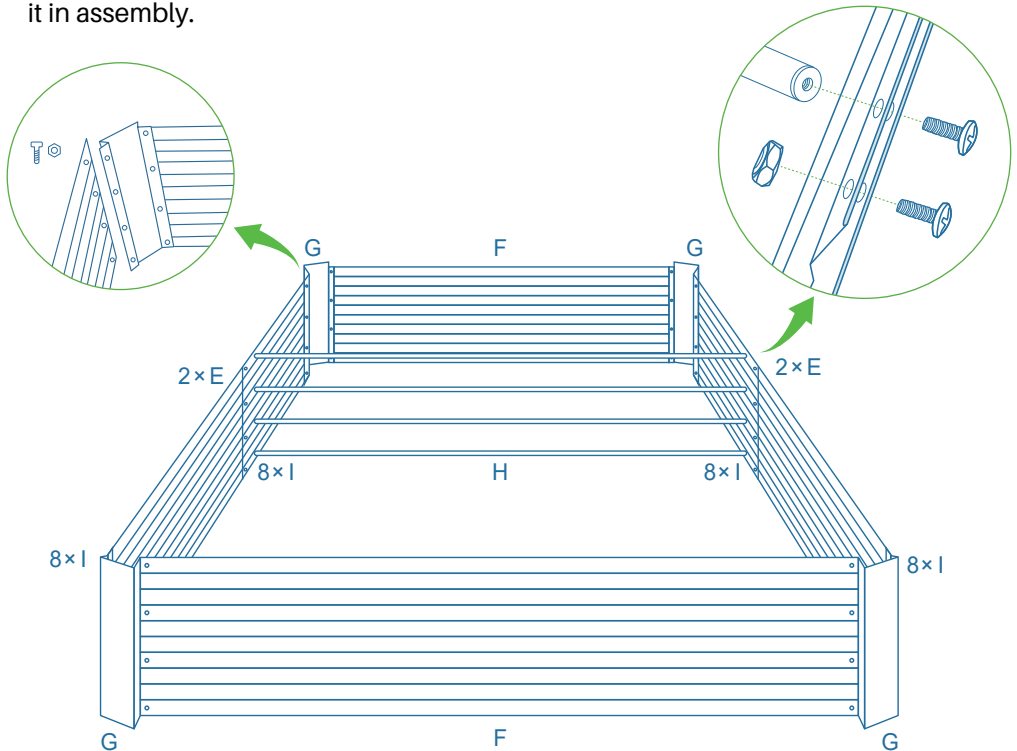

96" x 48" x 11.8"

You'll receive only one (1) box. Please make sure all parts are numbered and graphically indexed as shown, so does the quantity for each part upon arrival. If you need any help, please **CONTACT the support team** with the **order number, required parts, quantity for each part, and photos** (or videos, if applicable), we will get back to help out soon.

Parts List

- Apply to the model #GB-53S.
- Please always wear the gloves (#J) in assembly.
- It's up to you whether to lay the Weed Barrier (#L) before the assembly or not.
- The Plant Support Cage (#M) is the gift for your future gardening. You'll **NOT** use it in assembly.



Part Number	Diagram	Description	Quantity (PCS)
#E		Long Metal Sheet	4
#F		Short Metal Sheet	2
#G		Corner Sheet	4
#H		Middle Supporting Pole	4
#I		Bolt	48 Bolts & 40 Nuts
#J		Glove	2 (1 Pair)
#L		Weed Barrier	1
#M		Plant Support Cage	4

Assembly

Step 1. Layout all the Long Metal Sheets (#E) and all the Short Metal Sheets (#F).

Please note that when laying out the Long Steel Sheets, you should align the two rows of pre-drilled holes with each other in the middle.

Step 2. Connect each sheet with a Corner Sheet (#G) and several Bolts (#I) until you finish connecting the 4 corners.

Step 3. Add the Middle Supporting Poles (#H) to the middle of Long Steel Sheets.







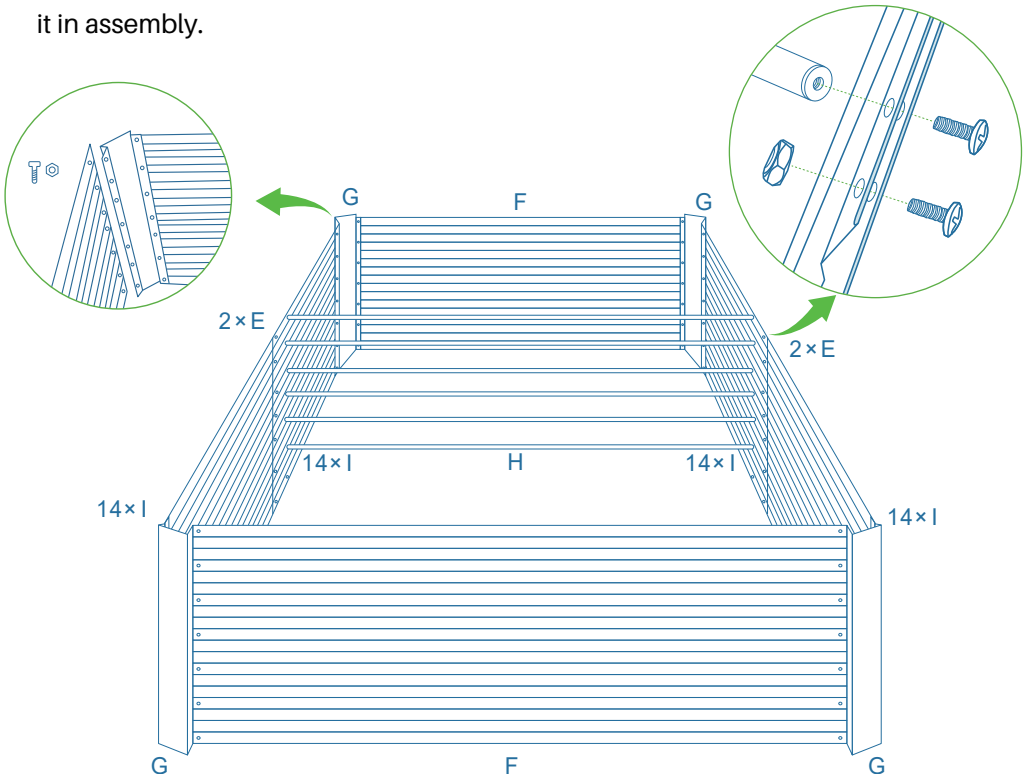

96" x 48" x 22.4"

You'll receive only one (1) box. Please make sure all parts are numbered and graphically indexed as shown, so does the quantity for each part upon arrival. If you need any help, please **CONTACT the support team** with the **order number, required parts, quantity for each part, and photos** (or videos, if applicable), we will get back to help out soon.

Parts List

- Apply to the model #GB-53H.
- Please always wear the gloves (#J) in assembly.
- It's up to you whether to lay the Weed Barrier (#L) before the assembly or not.
- The Plant Support Cage (#M) is the gift for your future gardening. You'll **NOT** use it in assembly.



Part Number	Diagram	Description	Quantity (PCS)
#E		Long Metal Sheet	4
#F		Short Metal Sheet	2
#G		Corner Sheet	4
#H		Middle Supporting Pole	6
#I		Bolt	84 Bolts & 72 Nuts
#J		Glove	2 (1 Pair)
#L		Weed Barrier	1
#M		Plant Support Cage	4

Assembly

Step 1. Layout all the Long Metal Sheets (#E) and all the Short Metal Sheets (#F).

Please note that when laying out the Long Steel Sheets, you should align the two rows of pre-drilled holes with each other in the middle.

Step 2. Connect each sheet with a Corner Sheet (#G) and several Bolts (#I) until you finish connecting the 4 corners.

Step 3. Add the Middle Supporting Poles (#H) to the middle of Long Steel Sheets.

Maintenance

Generally, you do not need to pay special attention to maintaining your Quicent garden beds – they can last for years except for man-made damages on purpose or uncontrollable natural disasters.

However, for the models coming with a greenhouse, to keep it in optimal condition, please refer to our suggestions below:

- Please get the structure sheltered whenever in use. For example, set it up near a wall, a fence, etc.
- Please secure the cover at all times by tying all the ropes inside and fixing the extended part with extra weights (soil, bricks, stones, sandbags, etc.)
- If it's hot, especially in summer, please open the windows of the greenhouse, or use the garden bed only without the greenhouse.
- If you use the structure in winter, please clean up snow in time, or it would collapse due to overloading.
- Please understand that the local weather influences the performance. You could apply other equipment if higher temperatures are required.

Warranty

The limited warranty covering the materials and the craftsmanship under normal use and service conditions takes effect from the purchase date (on the invoice). We provide:

- 5-year warranty for the **Garden Bed**.
- 1-year warranty for the **Greenhouse**.

REMINDER

1. Please note that the order purchase proof (order number or shipping information on the shipping carton) is the only valid evidence to claim for warranty. In the event that you failed to access your order information online, we strongly advise you to keep the original packaging and shipping carton(s).
2. To get what you need as soon as possible, we strongly suggest you provide all of the following information **at your first inquiry**:
 - Order number
 - Part number
 - Quantity required for each part
 - Pictures (or video clips, if applicable)

WARNING

- Restructuring the product without written permission from Quiccent in advance would **VOID** the warranty.
- Damages due to improper use in severe weather conditions, including but not limited to high winds, heavy rain, sleet, snow, etc., will NOT be covered by the warranty.

Quictent

SHELTERS FOR MOST PEOPLE



QT-FBA-SGB-202201