

# User Manual

## for Quictent Carport

Basic Series (Model #YS1106) •



• Classic Series (Model #1113)

Upgraded Series (Model #1114) •



Please read, understand, and practice the guidelines in this user manual before use, and keep it for future reference.

10' x 20'

# Table of Contents

- About Quicent ..... 2
- Safety Instructions ..... 3
- Basic Series (Model #YS1106) ..... 5
- Classic Series (Model #1113) ..... 9
- Upgraded Series (Model #1114) ..... 14
- Maintenance ..... 19
- Warranty ..... 19
- Appendix ..... 20

# IMPORTANT

We'd love to hear from our customers. If you have any questions about the manual or would like us to help in any way, please feel free to contact the support team. We will reply in 12 hours.

- Check the **Spam** and your **email Settings** if you do not receive a reply in time as it is probably blocked because our support team will always get back to you no later than the timeframe.
- Add the following email address to your CONTACT LIST in case of any blocking.
- **Email: sales@quictents.com, maxlead.us@gmail.com.**

This user manual applies to Quicent 10' x 20' carport. It will help you to get to know your Quicent carport. Please read the guidelines in this manual and keep the manual for future reference.

We may update the manual without notice in advance. You can always search "**Quicent Instructions**" online for the latest version.

## About Quicent

Founded in the early 21st century, Quicent has grown into a popular brand with reliable products and excellent customer services during the past decades. We started with pop up canopies, and then expanded to other 6 categories for shelters and the like including party tents, carports, greenhouses, shade sails, patio umbrellas and grow tents. Driven by the vision to create unique spaces to meet every specific need and become a part of America's landscape, we at Quicent would spare no effort to keep innovating.

## Our Vision

Founded in the early 21st century, Quicent has grown into a popular brand with reliable products and excellent customer services during the past decades. We started with pop up canopies, and then expanded to other 6 categories for shelters and the like including party tents, carports, greenhouses, shade sails, patio umbrellas and grow tents. Driven by the vision to create unique spaces to meet every specific need and become a part of America's landscape, we at Quicent would spare no effort to keep innovating.

## Our Mission

To keep innovating and provide a wide range of reliable shelters and shades at consumer-grade prices with customer-first service.

## Our Service

The customer-centric services are what we at Quictent take great pride in. In addition to the hassle-free warranty covering all Quictent products, an industrial-leading support team is standing behind at all times. Whenever you need help or have any suggestions and comments about our products, do not hesitate to reach us via [sales@quictents.com](mailto:sales@quictents.com) or [maxlead.us@gmail.com](mailto:maxlead.us@gmail.com). You're sure to get a to-the-point reply in 12 hours.

## Safety Instructions

You should read, understand, and practice safety instructions in this chapter. For any damages due to not obeying guidelines as instructed, the owner (user) should take full responsibility.



Please **ALWAYS** weigh down your carport with sandbags, auger anchors, and (or) pegs.



Please do **NOT** place something heavy on the top as the shelter is designed to be a temporary structure.



Please do **NOT** light a fire inside and keep any heat source away from your storage shelter.



Do **NOT** throw away the original packaging cartons in case of a return or an exchange.

- Please **ALWAYS** weigh down your carport with sandbags, auger anchors, and (or) pegs.
- Please do **NOT** place something heavy on the top as the carport is designed to be a temporary structure.
- Please do **NOT** light a fire inside and keep any heat source away from your carport.
- Please do **NOT** throw away the original packaging cartons in case of a return or an exchange.

# Warning

Do NOT use this product in severe weather such as high wind, heavy rain, heavy snows, etc. Please take down the structure for any potential inclement weather. Damages caused by improper use will NOT be covered by the warranty.

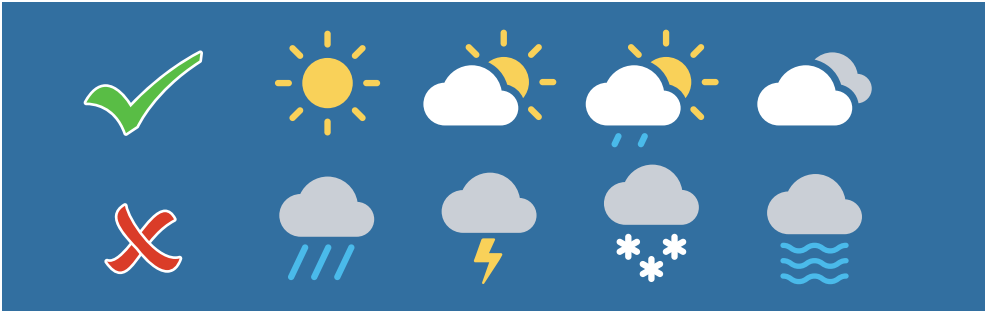

# Basic Series (Model #YS1106)





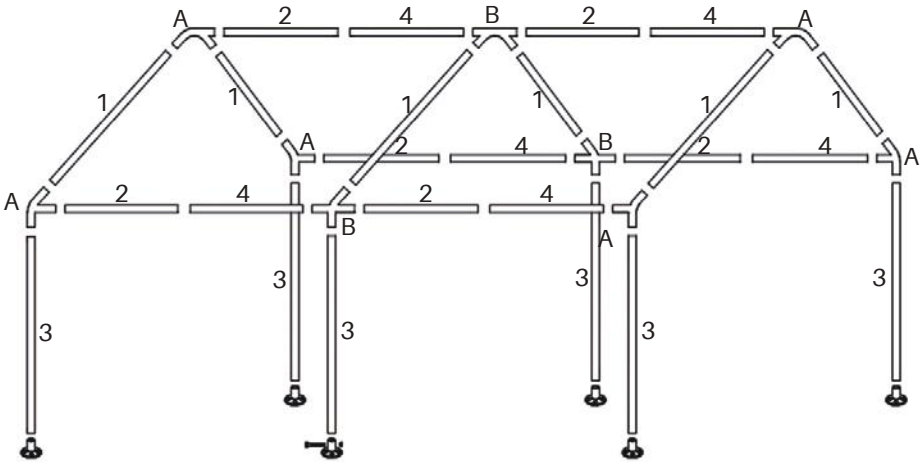

## Parts List

You'll receive one (1) box for this model. Please pay particular attention to making sure all parts are numbered and graphically indexed as shown on the Parts List, so does the quantity for each part. If you need any help, please contact us promptly ([sales@quicktents.com](mailto:sales@quicktents.com) or [maxlead.us@gmail.com](mailto:maxlead.us@gmail.com)) with the **ORDER NUMBER, REQUIRED PARTS (NAME, QUANTITY, and PART NUMBER), PICTURES (OR VIDEO CLIPS, IF APPLICABLE)**, we'll get back to help out soon.



Basic Series (Model #YS1106)

Part Number	Diagram	Description	Quantity (PCS)
#1		Steel Pole	6
#2		Steel Pole	6
#3		Steel Pole	6
#4		Steel Pole	6
#A		3-Way Corner Connector	6
#B		4-Way Corner Connector	3
#C		Roof Cover	1

Part Number	Diagram	Description	Quantity (PCS)
#D		L-Shaped Peg	6
#E		Auger Anchor	6
#F		Foot Base	6
#G		Screw	6
#H		Rope	6
#I		Bungee Cord	48

## Assembly Steps

Before the assembly, please check to make sure that you have all parts listed on the **Parts List**.

**Step 1** Layout and form the top frame with the poles (6 x #1, 6 x #2, and 6 x #4) and the connectors (6 x #A & 3 x #B).

### Reminder

There is a built-in snap at one end of the poles (#1, #2, and #4). Please snap to fix them together.

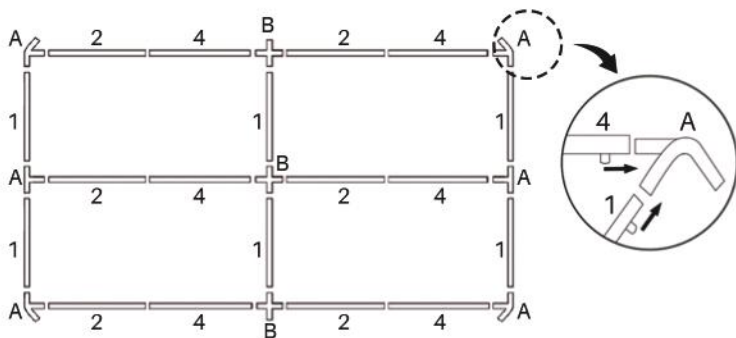

**Step 2** Fix the Roof Cover (#C) to the assembled top frame with the help of some Bungee Cords (#I).

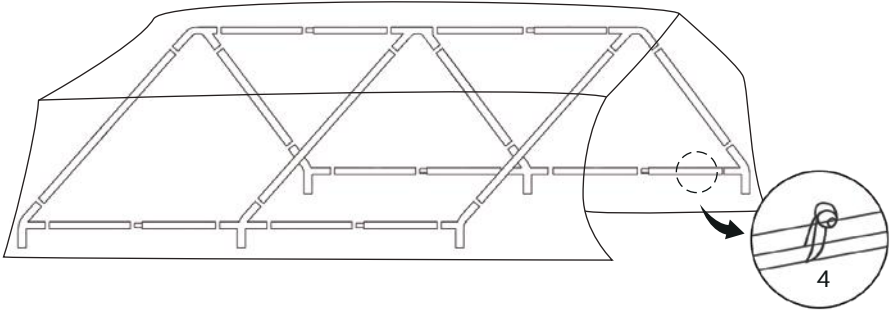

**Step 3** Start assembling the mainframe.

- Add 3 x poles (#3) to the connectors (#A & #B) on one side, then lift the structure from the other side (several adults required!).
- On the other side, add the rest 3 x poles (#3) to the connectors (#A & #B).

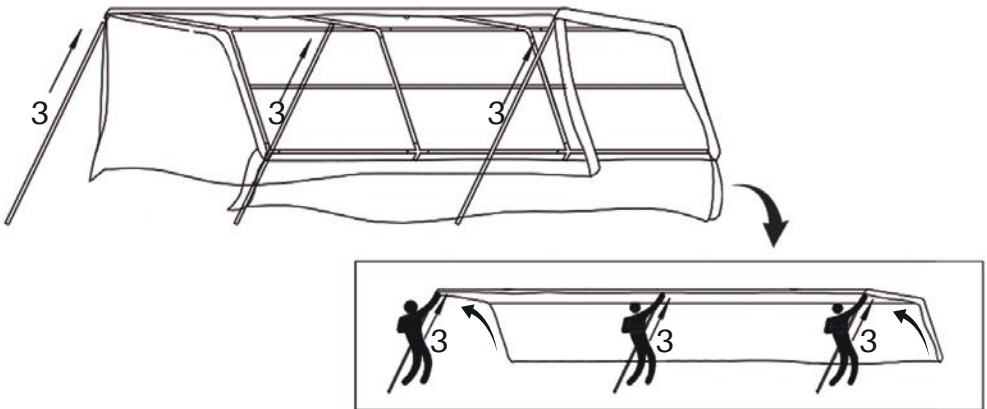



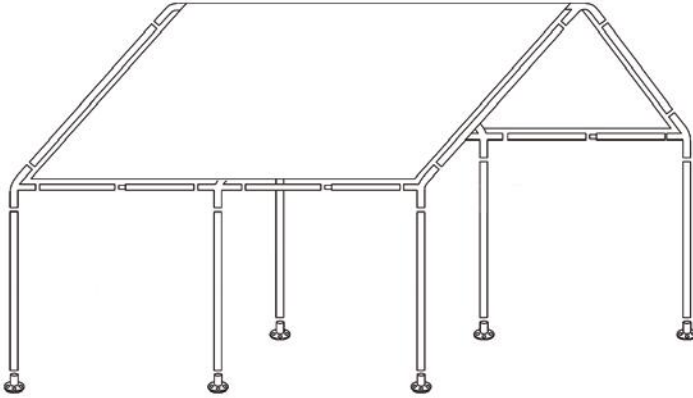

**Step 4** Secure the structure with the L-Shaped Pegs (#D), Auger Anchors (#E), Foot Bases (#F), Screws (#G), and Ropes (#H).

- a) Add a Foot Base (#F) to the bottom of each pole (#3), then fix with a Screw (#G). Repeat what you've done with the other 5 foot bases and poles (#3).
- b) Insert the 6 x L-Shaped Peg (#D) into the hole of 6 x Foot Bases (#F), one for each.
- c) Fix the whole structure to the ground with 6 x Ropes (#H) and 6 x Auger Anchors (#E). We highly recommend you diagonally insert the anchors when fixing the ropes to the ground. As shown, a 45-degree angle would be the best.

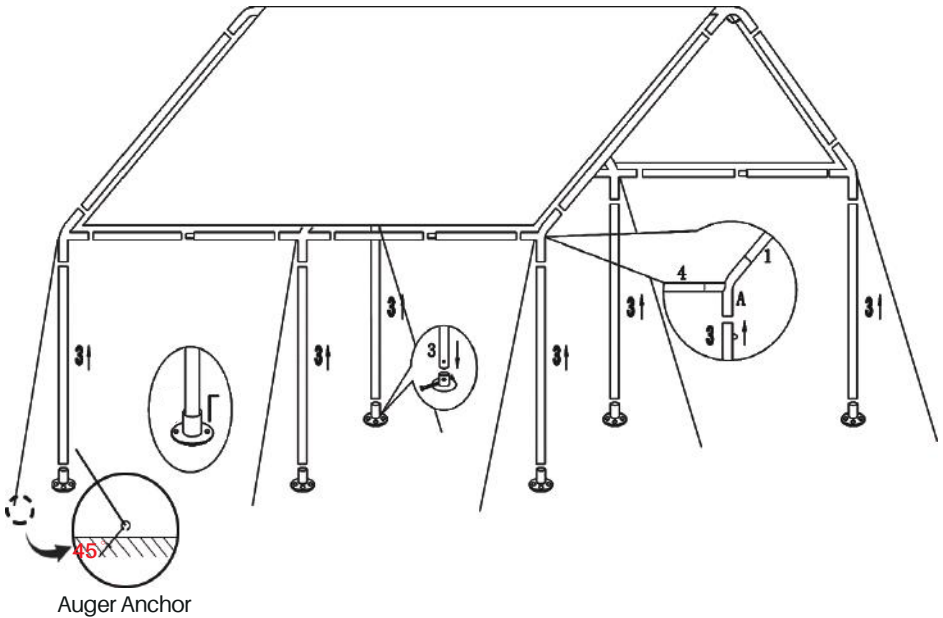







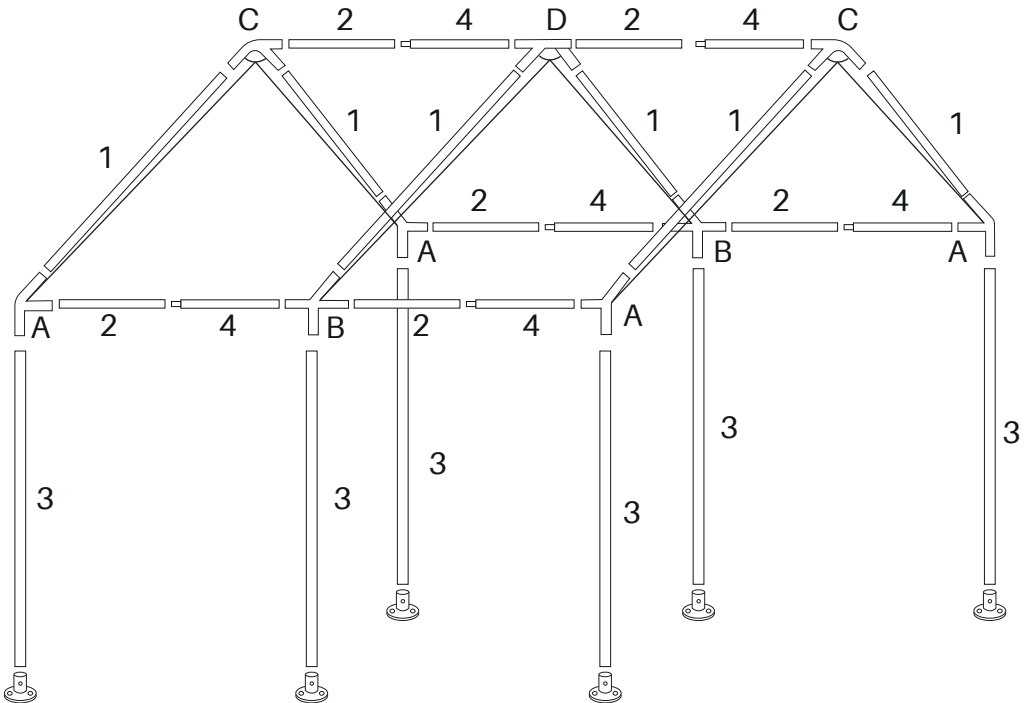



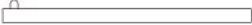





# Classic Series (Model #1113)

## Parts List

You'll receive one (1) box for this model. Please pay particular attention to making sure all parts are numbered and graphically indexed as shown on the **Parts List**, so does the quantity for each part. If you need any help, please contact us promptly ([sales@quictents.com](mailto:sales@quictents.com) or [maxlead.us@gmail.com](mailto:maxlead.us@gmail.com)) with the **ORDER NUMBER, REQUIRED PARTS (NAME, QUANTITY, and PART NUMBER), PICTURES (OR VIDEO CLIPS, IF APPLICABLE)**, we'll get back to help out soon.



### Classic Series (Model #1113)

Part Number	Diagram	Description	Quantity (PCS)
#1		Steel Pole	6
#2		Steel Pole	6
#3		Steel Pole	6
#4		Steel Pole	6
#A		3-Way Corner Connector	4
#B		4-Way Corner Connector	2
#C		3-Way Corner Connector	2
#D		4-Way Corner Connector	1
#E		Steel Cable	3
#F		Foot Base	6
#G		Roof Cover	1
#H		L-Shaped Peg	6
#I		Auger Anchor	6
#J		Screw	6
#K		Rope	6
#L		Bungee Cord	48
#M		Sandbag	4
#N		Glove	2 (A Pair)

## Assembly Steps

- Before the assembly, please check to make sure that you have all parts listed on the **Parts List**.
- For your safety, please always wear gloves (#N) before and during the assembly.

**Step 1** Form the top frame as per the following steps.

- a) Layout the frame with the poles (6 x #1, 6 x #2, and 6 x #4) and the connectors (4 x #A, 2 x #B, 2 x #C, and 1 x #D).
- b) Put the two ends of each Steel Cable (#E) onto the ends of connectors (#A & #B) as shown.
- c) Fix all the poles and connectors together by snapping the built-in pins.

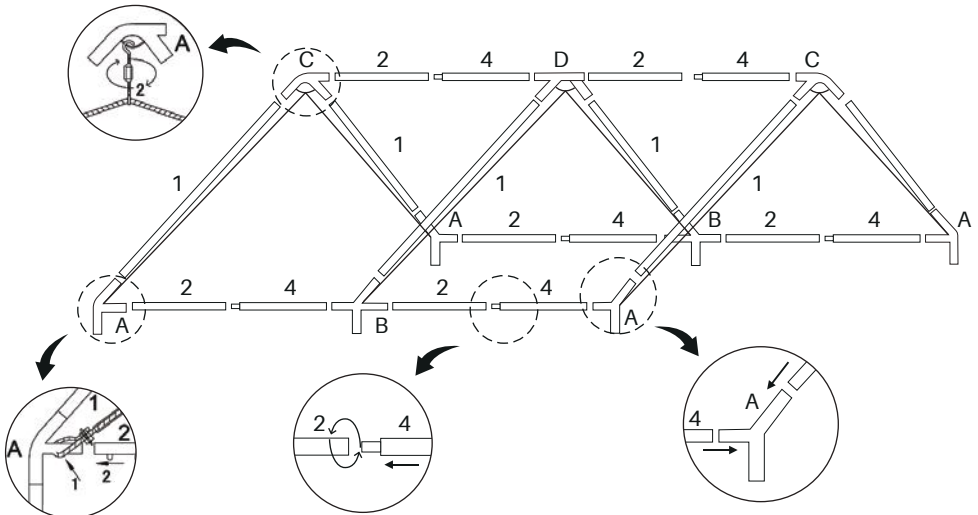
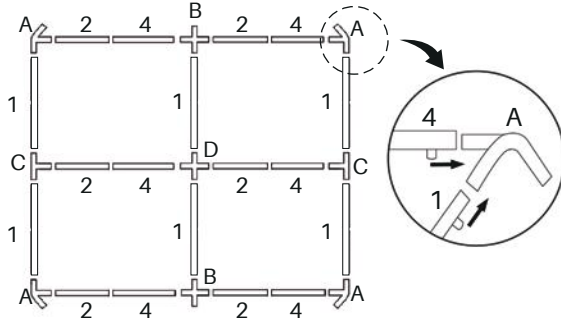

**Step 2** Adjust the 3 x Steel Cables (#E).

- a) Hook the cables to the connectors (#C & #D) at the top.
- b) Tighten/loosen the cables to a proper height with the help of the height controller.

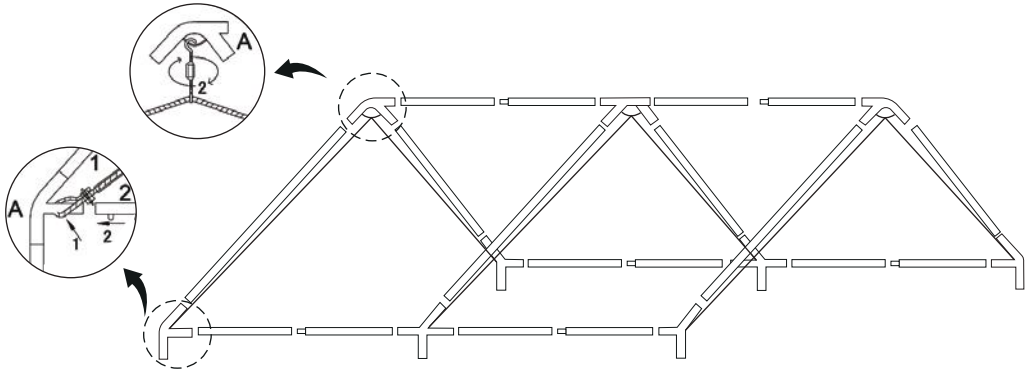

**Step 3** Start assembling the mainframe.

- a) Fix the Roof Cover (#G) to the assembled top frame with the help of some Bungee Cords (#L).
- b) Add 3 x poles (#3) to the connectors (#A & #B) on one side, then lift the structure from the other side (several adults required!).
- c) On the other side, add the rest 3 x poles (#3) to the connectors (#A & #B).

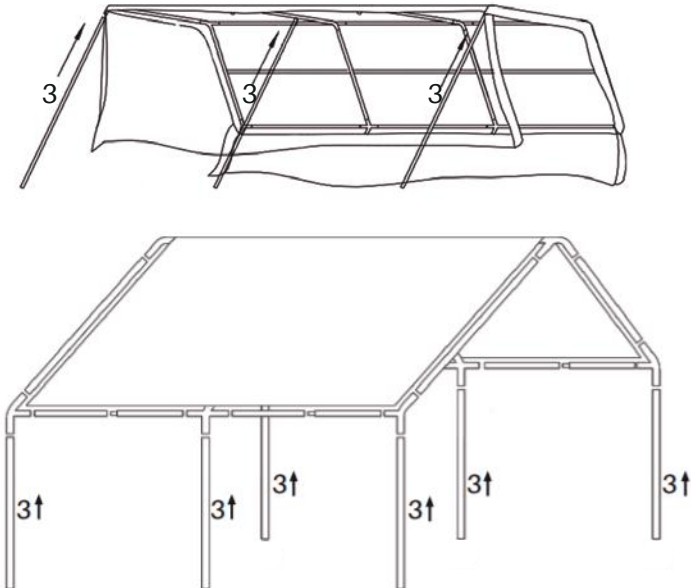

**Step 4** Secure the whole structure.

- a) Connect each pole (#3) at the bottom with a Foot Base (#F) by using a Screw (#J).
- b) Insert an L-Shaped Peg (#H) into the hole of each Foot Base (#F).
- c) Secure the whole structure with 6 x Ropes (#K) and 6 x Auger Anchors (#I). We highly recommend you diagonally insert the pegs when fixing the ropes to the ground. As shown, a 45-degree angle would be the best.
- d) Weigh the structure down with 4 x Sandbags (#M) at the four corners.

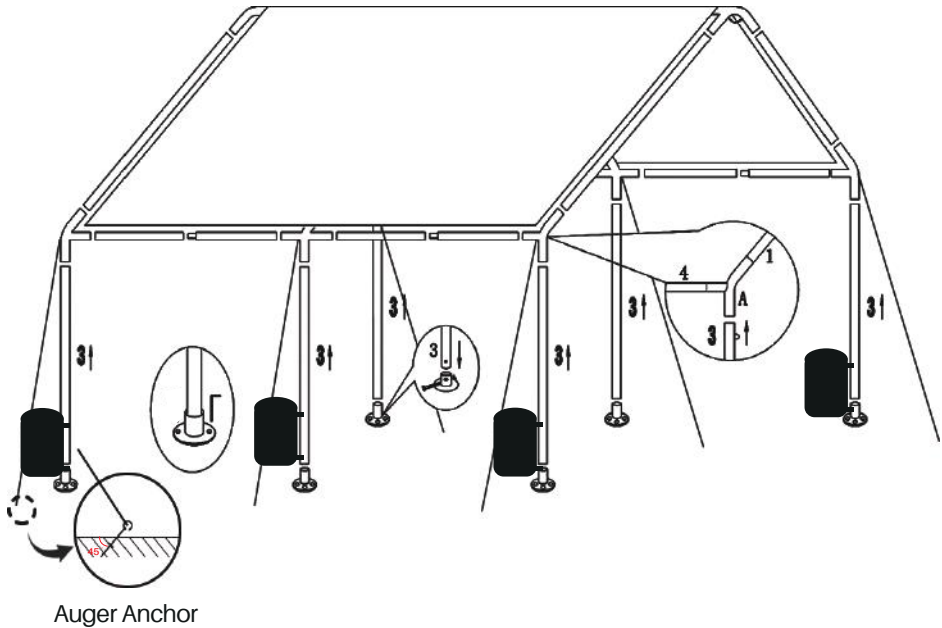

# Upgraded Series (Model #1114)





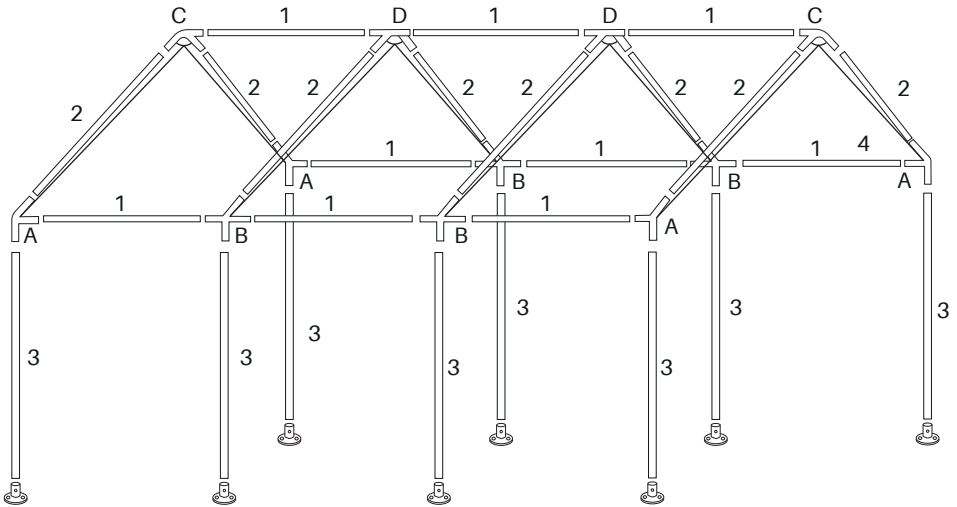



## Parts List

You'll receive two (2) boxes for this model. Please pay particular attention to making sure all parts are numbered and graphically indexed as shown on the **Parts List**, so does the quantity for each part. If you need any help, please contact us promptly ([sales@quictents.com](mailto:sales@quictents.com) or [maxlead.us@gmail.com](mailto:maxlead.us@gmail.com)) with the **ORDER NUMBER, REQUIRED PARTS (NAME, QUANTITY, and PART NUMBER), PICTURES (OR VIDEO CLIPS, IF APPLICABLE)**, we'll get back to help out soon.



**Table A. Parts List for Model #1114**

Part Number	Diagram	Description	Quantity (PCS)
#1		Steel Pole	9
#2		Steel Pole	8
#3		Steel Pole	8
#A		3-Way Corner Connector	4
#B		4-Way Corner Connector	4
#C		3-Way Corner Connector	2
#D		4-Way Corner Connector	2

Part Number	Diagram	Description	Quantity (PCS)
#E		Roof Cover	1
#F		Foot Base	8
#G		L-Shaped Peg	8
#H		Auger Anchor	8
#I		Screw	8
#J		Rope	8
#K		Bungee Cord	40
#L		Steel Cable	4

**Table B. Package Contents for Shipping Cartons**

Carton Number	Parts Included
Box #1	9 x Part #1 (Steel Pole) 8 x Part #2 (Steel Pole) 8 x Part #3 (Steel Pole)
Box #2	4 x Part #A (3-Way Corner Connector) 4 x Part #B (4-Way Corner Connector) 2 x Part #C (3-Way Corner Connector) 2 x Part #D (4-Way Corner Connector) 1 x Part #E (Roof Cover) 8 x Part #F (Foot Base) 8 x Part #G (L-Shaped Peg) 8 x Part #H (Auger Anchor) 8 x Part #I (Screw) 8 x Part #J (Rope) 40 x Part #K (Bungee Cord) 4 x Part #L (Steel Cable)



## Assembly Steps

Before the assembly, please check to make sure that you have all parts listed on the **Parts List**.

**Step 1** Form the top frame as per the following steps.

- Layout the frame with the poles (9 x #1 & 8 x #2) and the connectors (4 x #A, 4 x #B, 2 x #C, and 2 x #D).
- Put the two ends of each Steel Cable (#L) onto the ends of connectors (#A & #B) as shown.
- Fix all the poles and connectors together by snapping the built-in pins.

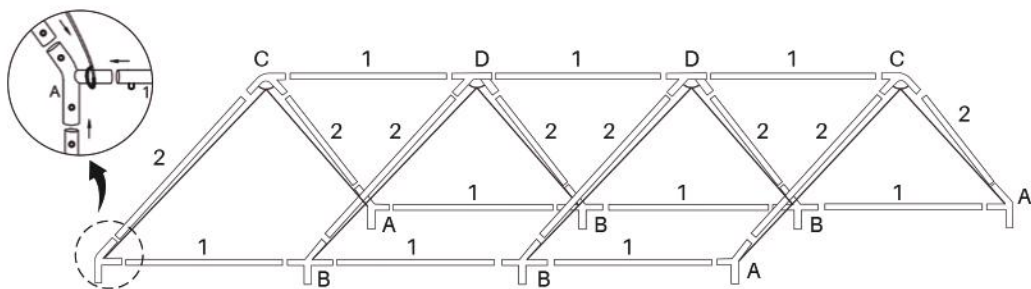
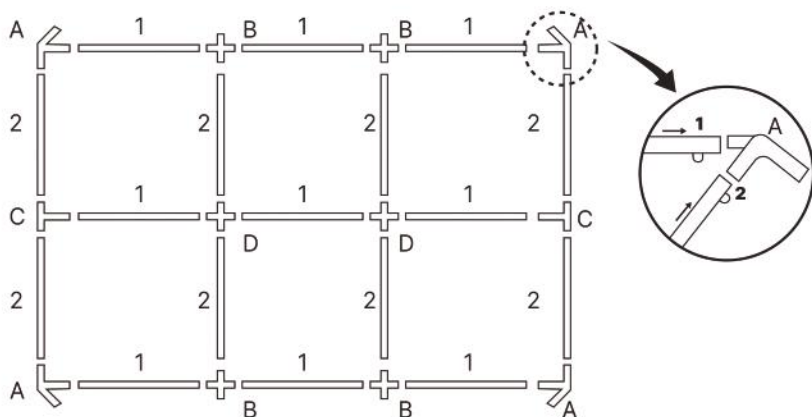

**Step 2** Adjust the 4 x Steel Cables (#L).

- Hook them to the connectors (#C & #D) at the top.
- Tighten/loosen the cables to a proper height with the help of the height controller.

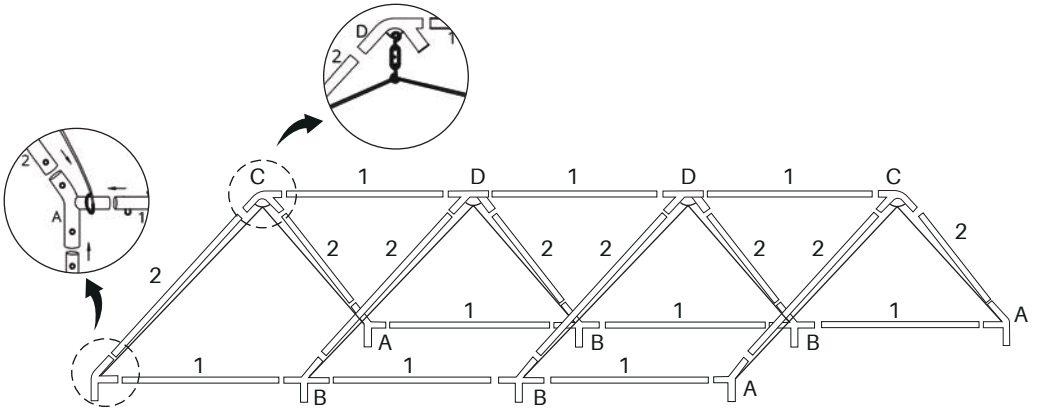

**Step 3** Start assembling the mainframe.

- a) Fix the Roof Cover (#E) to the assembled top frame with the help of some Bungee Cords (#K).
- b) Add 4 x poles (#3) to the connectors (#A & #B) on one side, then lift the structure from the other side (several adults required!).
- c) On the other side, add the rest 4 x poles (#3) to the connectors (#A & #B).

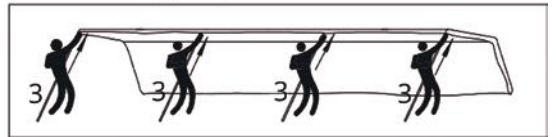
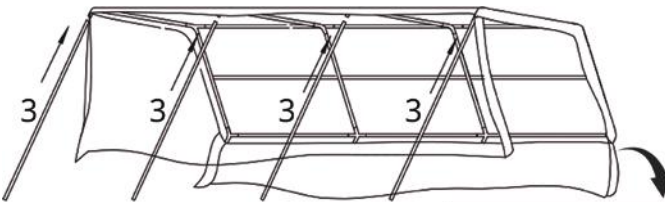
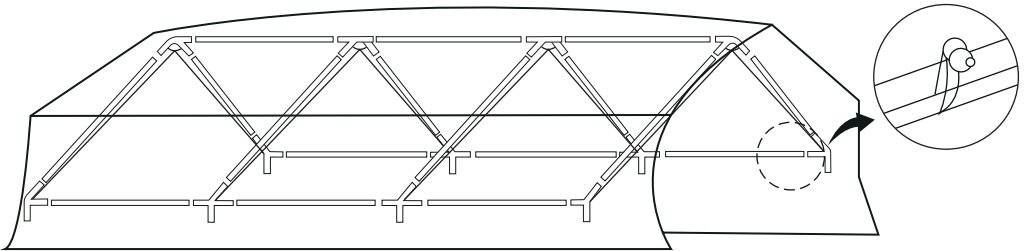

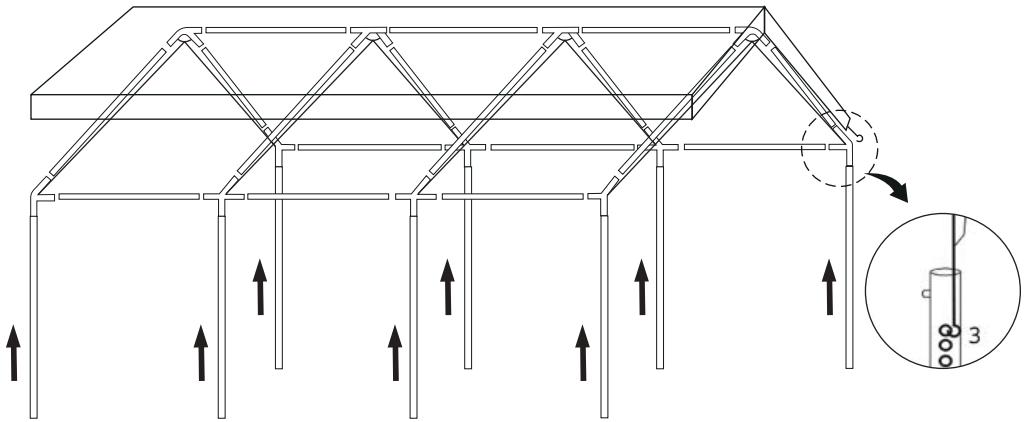

**Step 4** Secure the whole structure.

- a) Connect each pole (#3) at the bottom with a Foot Base (#F) by using a Screw (#I).
- b) Insert an L-Shaped Peg (#G) into the hole of each Foot Base (#F).
- c) Secure the whole structure with 8 x Ropes (#J) and 8 x Auger Anchors (#H). We highly recommend you diagonally insert the pegs when fixing the ropes to the ground. As shown, a 45-degree angle would be the best.

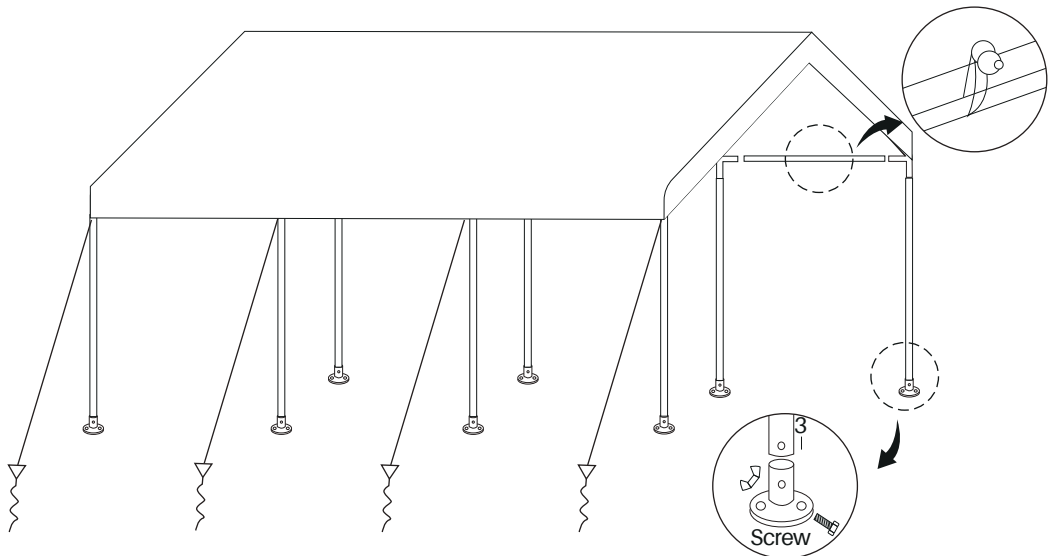

## Maintenance

To help you maintain your carport in optimal condition, please refer to our suggestions below.

- When in use, make sure to brush off dirt and debris and keep away from potentially damaging objects.
- Clean the cover and sidewalls with water and mild detergent (or non-detergent, if applicable) only.
- To prevent your carport from rust and mildew, please clean all disassembled parts and dry them completely before storing them.
- Store the disassembled carport in a cool and dry place and keep away from animals.
- Inspect your tent carefully before and after each use. If any rips, tears, or damage is found, stop using it and email the support team ([sales@quictents.com](mailto:sales@quictents.com) or [maxlead.us@gmail.com](mailto:maxlead.us@gmail.com)) with the **ORDER NUMBER, PART NUMBER, QUANTITY REQUIRED, and ANY PHOTOS (OR VIDEO CLIPS, IF APPLICABLE)**, we will get back to you in 12 hours.

## Warranty

The limited warranty covering the materials and the craftsmanship under normal use and service conditions takes effect from the purchase date (on the invoice). Please note that the order purchase proof (order number or shipping information on the shipping carton) is the only valid evidence to claim for warranty.

- **12-month** warranty for the Steel Pole, Cover, and Zipper Door.
- A **lifetime** warranty for all the small accessories not mentioned above, including the Connectors, Pegs, Auger Anchors, Foot Bases, etc.

## Reminders

1. In the event that you failed to access your order information online, we strongly advise you to keep the original packaging and shipping carton(s) because they are treated as a proof of purchase.
2. To get what you need as soon as possible, we strongly suggest you provide all of the following information **at your first inquiry**:
  - Order number
  - Required parts (name, quantity, and part number for each)
  - Pictures (or video clips, if applicable)

## Warning

- Restructuring the product without written permission from Quictent in advance would **VOID** the warranty.
- Damages due to improper use in severe weather conditions, including but not limited to high winds, heavy rain, sleet, snow, etc., will **NOT** be covered by the warranty.

# Appendix

## • Shelter for Backyard, Party, Event

### Pop up Canopy



Quicent pop up canopies serve perfectly for your outdoor events, both personally and commercially. They always provide shades for outdoor activities such as parties, picnics, outings, etc, turning everywhere into a perfect place to relax. When it comes to selling at outdoor events, they are easy to handle in all aspects - unfolding (and folding), transporting, and storing. Rich in styles, sizes, and colors, you can always find one that goes well with your needs.

### Party Tent



Preparing for parties and events? We've got your back. Quicent party tents in different sizes are available. From a small-sized one in 10' x 8' to some regular sizes in 10' x 20' or 10' x 30' to a large one in 20' x 40', you can always find a perfect solution matching your demands. What's more, they span a wide range of styles.

## Metal Gazebo



Owning a Quictent metal gazebo is just like having another beautiful room in your backyard! The powder-coated steel frame is heavy-duty and can stand firmly outdoors for a long time. The mosquito netting adds privacy and protects you from bugs. The tan ones go with the surroundings well while the red ones are eye-catching.



## Patio Umbrella

Quictent patio umbrellas turn anywhere in the open air into a perfect site to "take a breath". They are a must-have for small businesses such as an outdoor café! For homeowners, they make your backyard the best place to relax, especially when you're looking for an escape from the heavy work or energy-taking daily travails.

## Shade Sail

Why Quictent provides so many choices for shade sails in colors and shapes? For aesthetics. Your patio would be pleasing to the eye if you mix shades in different colors and shapes, or overlap one a little while mounting others several feet higher or lower.



## • Shelter for Vehicle

### Carport



The Quicent carports share something in common: They are heavy-duty, easy-to-assemble, and of the most importance, supported by an industrial-leading after-sales service. You can choose from the ones with or without sidewalls depending on your needs.



### Motorcycle Shelter

Recommended by so many riders, Quicent motorcycle shelters are proved to be the ultimate solution to protect your motorcycle from the elements. Buy one to see how the well-made cover and the heavy-duty structure realize the great protection.

### Garage Shed

A Quicent outdoor storage shed is not only a budget-friendly solution to keep your belongings safe, but also helps organize your life – gone is the backyard/basement clutter.



## Truck Tent



Light in weight and excellent in performance, Quicent truck bed tents are always a safer and more comfortable choice for road trips with a pickup truck. They can protect you from the elements when traveling and keep warm & keep you away from the crawling insects when sleeping. More importantly, whenever you want to stop to rest, the big awning would get you sheltered. Take one home and get your pickup ready for a trip!

## RV Cover



The Quicent RV covers are a great investment for trailers of all kinds. Besides the great protection provided by the 6-layered tear-, water-, and UV-resistant cover, extra reinforced wind straps are the bonus coming with each order.



# • Shelter for Plant

## Greenhouse



As a necessity for all gardeners, Quicent greenhouses provide an ideal environment to ensure efficient growth and longer growing seasons. Available in mini, medium, and large walk-in ones.

## Grow Tent



We highly recommend Quicent grow tents for anyone wanting to grow indoors. Passed the SGS certification, they'll help create an optimal growing environment. You're sure to be surprised by lots of built-in features like more reflective cover materials, the big observation window, convenient hooks, a waterproof tray floor, etc. Take one home to be the master of the temperatures, lights, humidity, and the like for your plants!

## Garden Bed



A Quicent raised garden bed is highly recommended for gardening beginners since it makes you the controller of the size, location, as well as factors like soil conditions. An elevated one is the ultimate solution for gardeners with back pain or knee issues.





**Quictent**  
SHELTERS FOR MOST PEOPLE



QT-YS-CARPORT-202201