

USER MANUAL

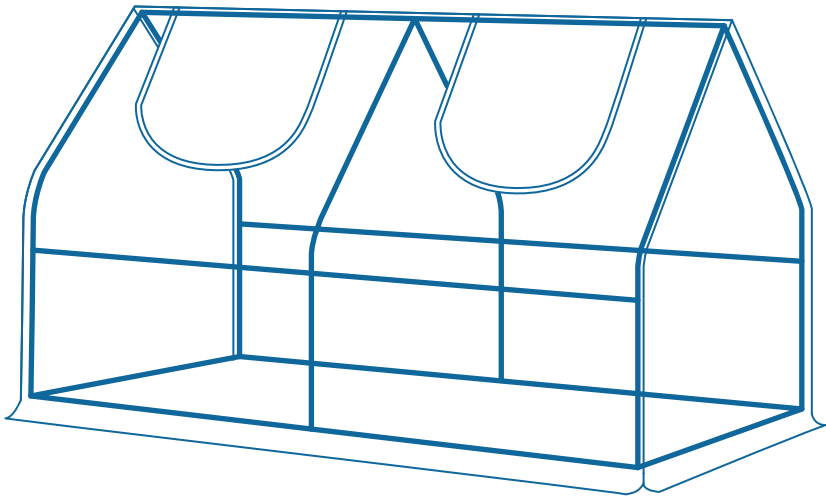

Please read, understand, and practice guidelines in this user manual before use, and keep it for future reference.

71" x 36" x 36"
95" x 36" x 36"

56" x 29" x 77"
56" x 56" x 77"

* Use indoors or in a sheltered place.

Table of Contents

- About Quicentent 4
- 71" x 36" x 36" 5
- 95" x 36" x 36" 6
- 56" x 29" x 77" 15
- 56" x 56" x 77" 22
- Maintenance 29
- Warranty 29

IMPORTANT

We'd love to hear from our customers. If you have any questions about the manual, would like us to help in any way, or have any suggestions and comments, please feel free to contact the support team. We will reply in 12 hours (business days).

Other Greenhouses from Quiccent



Size: **10' x 9' x 8'**

Model **#1302**



Size: **12' x 7' x 7'**

Model **#1303**



Size: **20' x 10' x 7'**

Model **#1306**



Size: **20' x 10' x 7'**

Model **#1306G**

Upgraded version of Model #1306

Available in 2 colors: Green and White



Size: **98" x 49" x 53"**

Model **#0163**

Available in 2 colors: Dark and Green



This user manual applies to Quiccent mini greenhouses. It will help you to get to know your Quiccent mini greenhouse. Please read the guidelines in this manual and keep the manual for future reference.

We may update the manual without notice in advance. You can always search **“Quiccent Instructions”** online for the latest version.

About Quiccent

Founded in the early 21st century, Quiccent has grown into a popular brand with reliable products and excellent customer service during the past decades. We started with pop up canopies, and then expanded to other more categories of shelters and the like including party tents, carports, greenhouses, garden beds, grow tents, shade sails, patio umbrellas and RV covers. Driven by the vision to create unique spaces to meet every specific need and become a part of America's landscape, we at Quiccent would spare no effort to keep innovating.

Our Vision

To create unique spaces to meet every specific need, and become a part of America's landscape.

Our Mission

To keep innovating and provide a wide range of reliable shelters and shades at consumer-grade prices with customer-first service.

Our Service

The customer-centric service is what we at Quiccent take great pride in. In addition to the hassle-free warranty covering all Quiccent products, an industrial-leading support team is standing behind at all times. Whenever you need help or have any suggestions and comments, do not hesitate to contact us. You're sure to get a to-the-point reply in 12 hours.

71" x 36" x 36"



Model **#1310**

1 * Clear PVC Cover



Model **#1312**

1 * Green PE Cover



Model **#1312W**

1 * White PE Cover



Model **#1315**

2 * Covers: a Green PE Cover + a Clear PVC Cover







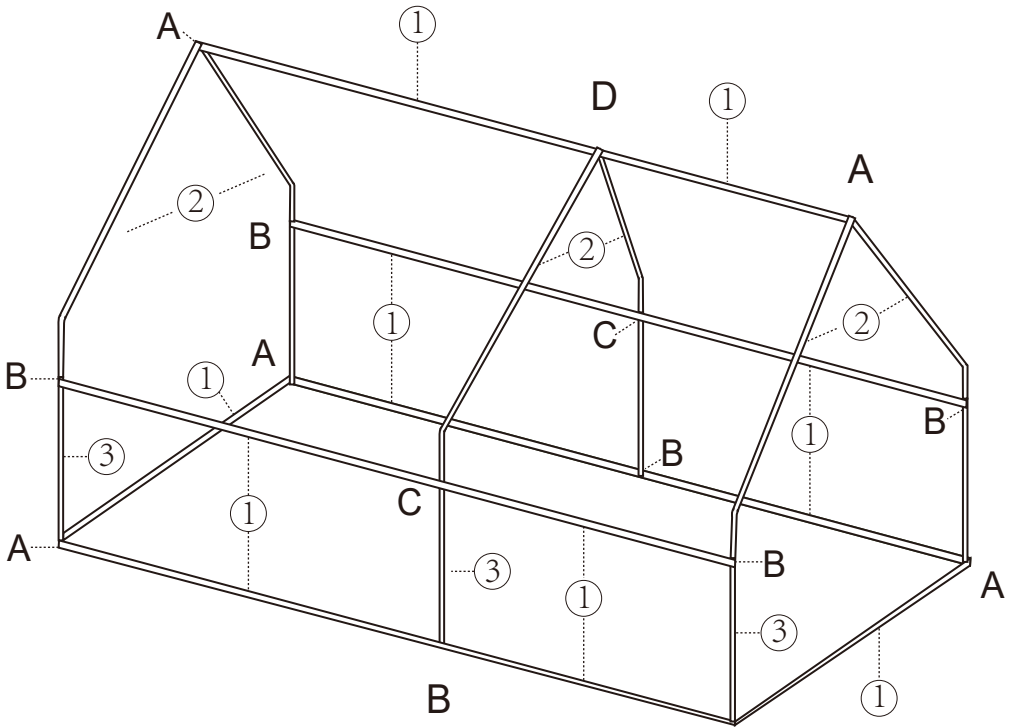

IMPORTANT!

- Apply to **Model #1310, Model #1312, Model #1312W, and Model #1315.**
- All the models in this size have the **SAME** frame (both the structure and materials) with the parts numbered from **#1 - #D in the Parts List.**
- You can tell the model from each other according to the **COVER (part #4 in the Parts List)** you received.

Parts List

Please refer to this chapter if you're owning a Quicent mini greenhouse in 71" x 36" x 36". All parts come in one (1) box only. Please pay particular attention to make sure all parts are numbered and graphically indexed, so does the quantity for each part as per the Parts List below. If you need any help, please **EMAIL the support team** at your earliest convenience with **the order number, required part(s), quantity for each part, and photos (or video clips, if applicable)**, we'll get back soon to help out.



Part Number	Diagram	Description	Quantity (PCS)
#1		Long Pole (30.3")	12
#2		Pole with Curved End	6
#3		Short Pole (12.8")	8
#A		3-Way Connector	6
#B		T-Shaped 3-Way Connector	6
#C		X-Shaped 4-Way Connector	2
#D		4-Way Connector	1
#E		<p>1 * Clear PVC Cover for Model #1310</p> <p>1 * Green PE Cover for Model #1312</p> <p>1 * White PE Cover for Model #1312W</p> <p>2 * Covers (A Clear PVC Cover + A Green PE Cover) for Model #1315</p>	

Assembly

Read Before the Assembly

- ✓ Check to make sure that you have all parts listed on the **Parts Lists**.
- ✓ Before moving to the next step, please make sure the end of the poles are aligned with the bottom of the connectors, which indicates that the poles are fully seated inside the connectors.

Step 1 Connect the poles (#1) with the connectors (#A & #B). You'll use:

- 4 x Part #1
- 2 x Part #4
- 4 x Part #A
- 2 x Part #B

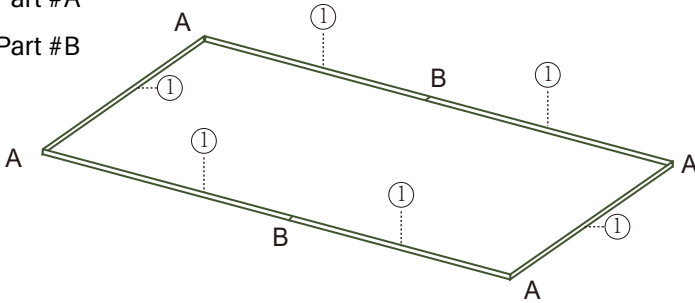

Step 2 Insert the poles (#3) into the connectors (#A & #B), then put the connectors (#B & #C) on the top of each pole. You'll use:

- 6 x Part #3
- 4 x Part #B
- 2 x Part #C

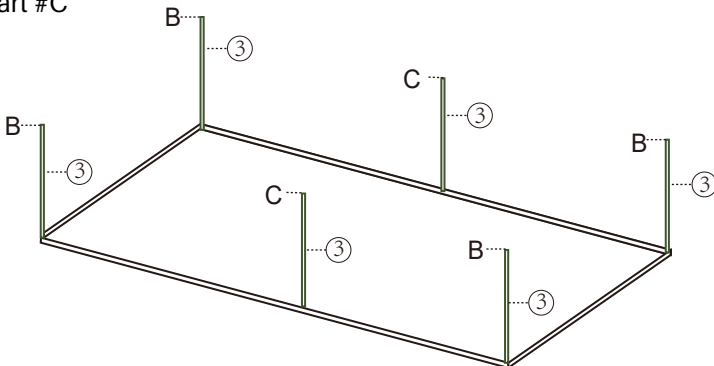

Step 3 Connect the poles (#1 & #2) with the assembled connectors (#B & #C).

You'll use:

4 x Part #1

6 x Part #2

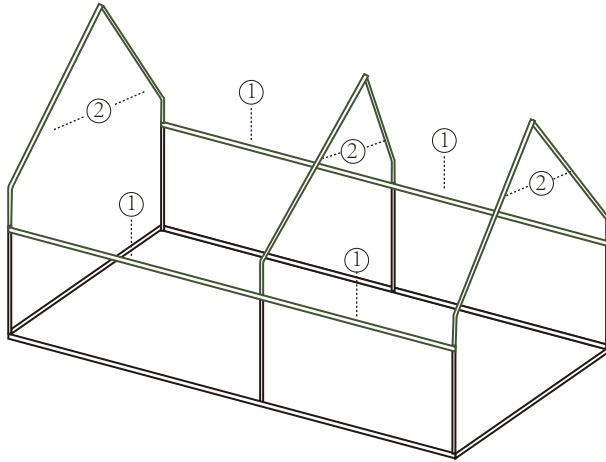

Step 4 Connect the poles (#1) with the connectors (#A & #D). You'll use:

2 x Part #1

2 x Part #A

1 x Part #D

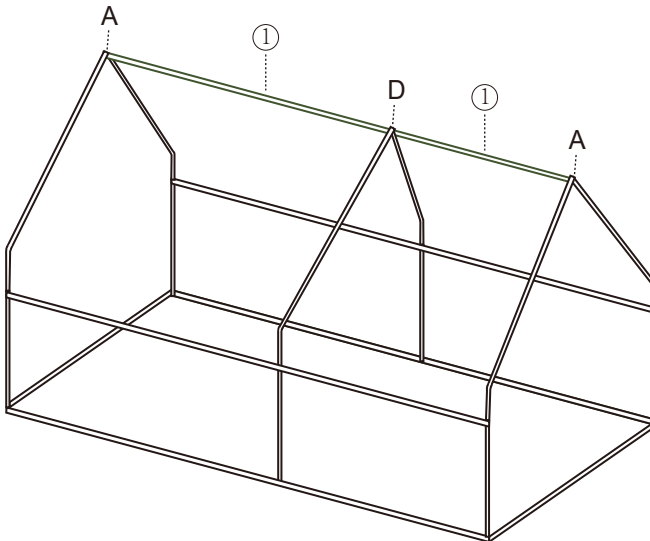

Step 5 Put on the cover.

95" x 36" x 36"



Model **#1316** with a Clear PVC Cover



Model **#1318** with a Green PE Cover









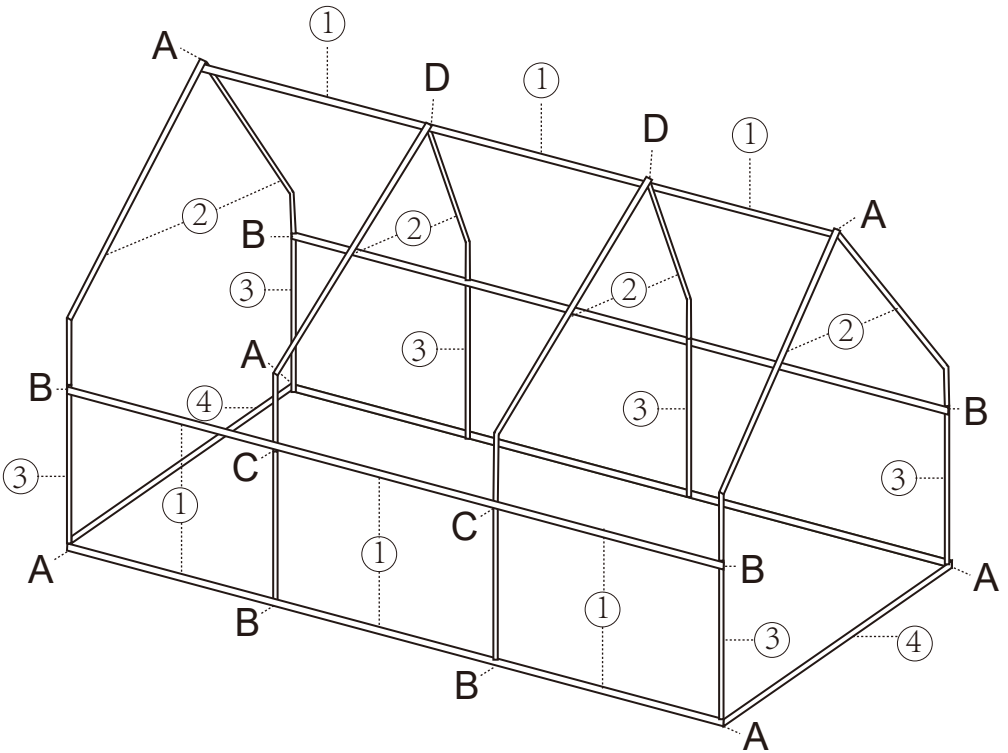

IMPORTANT!

- The two models in this size (**Model #1316 & Model #1318**) are the SAME except for the **COVER (#F)**.
- Model #1316 has a clear PVC cover.
- Model #1318 has a green PE cover.

Parts List

Please refer to this chapter if you're owning a QuicTent mini greenhouse in 95" x 36" x 36" (**Model #1316 & Model #1318**). All parts come in one (1) box only. Please pay particular attention to make sure all parts are numbered and graphically indexed, so does the quantity for each part as per the Parts List below. If you need any help, please **EMAIL the support team** at your earliest convenience with **the order number, required part(s), quantity for each part, and photos (or video clips, if applicable)**, we'll get back soon to help out.



Part Number	Diagram	Description	Quantity (PCS)
#1		Long Pole (30.3")	12
#2		Pole with Curved End	8
#3		Pole (12.8")	8
#4		Long Pole (33.5")	2
#A		90-Degree 3-Way Connector	6
#B		T-Shaped 3-Way Connector	8
#C		X-Shaped 4-Way Connector	4
#D		4-Way Connector	2
#E		Stake	8
#F		Cover	1

Assembly

Read Before the Assembly

- ✓ Check to make sure that you have all parts listed on the **Parts Lists**.
- ✓ Before moving to the next step, please make sure the end of the poles are aligned with the bottom of the connectors, which indicates that the poles are fully seated inside the connectors.

Step 1 Connect the poles (#1 & #4) with the connectors (#A & #B). You'll use:

- 6 x Part #1
- 2 x Part #4
- 4 x Part #A
- 4 x Part #B

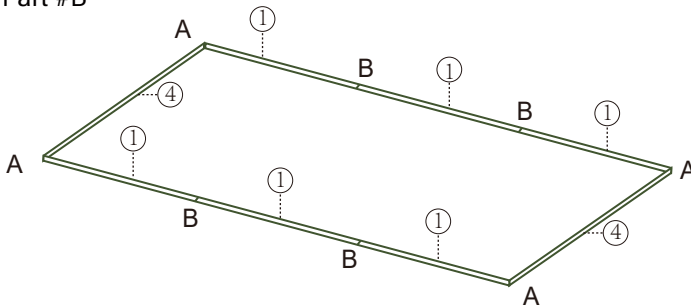

Step 2 Insert the poles (#3) into the assembled connectors (#A & #B), then put the connectors (#B & #C) on the top of each pole. You'll use:

- 8 x Part #3
- 4 x Part #B
- 4 x Part #C

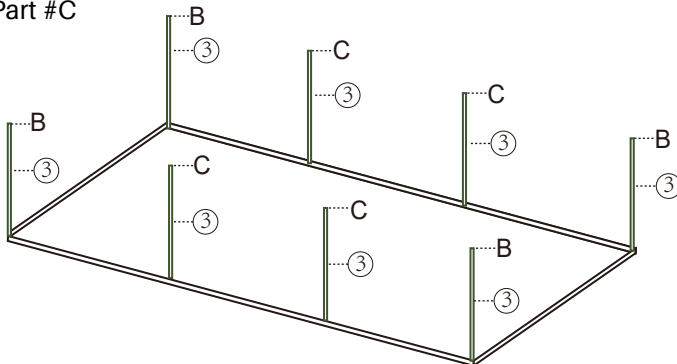

Step 3 Connect the poles (#1 & #2) with the assembled connectors (#B & #C).

You'll use:

6 x Part #1

8 x Part #2

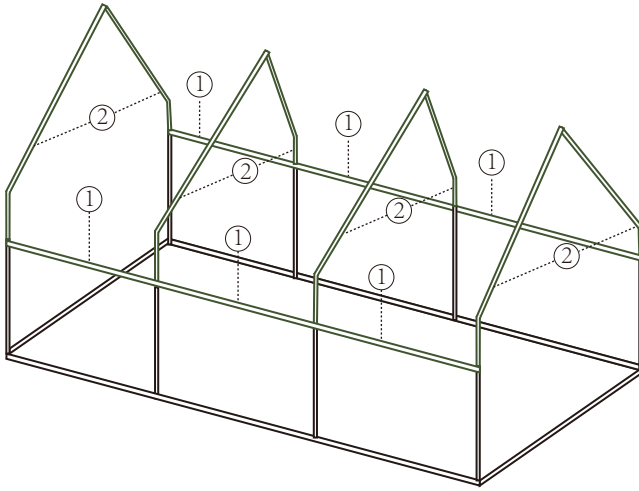

Step 4 Connect the poles (#1) with the connectors (#A & #D). You'll use:

3 x Part #1

2 x Part #A

2 x Part #D

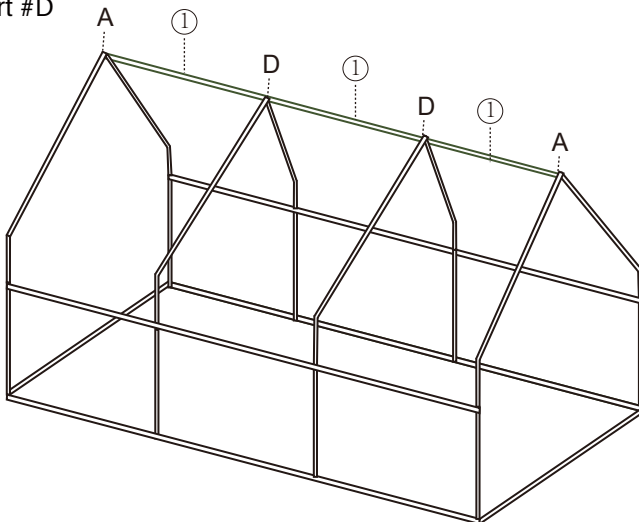

Step 5 Put on the cover.

56" x 29" x 77"



Model **#1309** with a Clear PVC Cover











Model **#1309G** with a Green PE Cover

IMPORTANT!

- The two models in this size (**Model #1309 & Model #1309G**) are the SAME except for the **COVER (#J)**.
- Model #1309 has a clear PVC cover.
- Model #1309G has a green PE cover.

Parts List

Please refer to this chapter if you're owning a Quiccent mini greenhouse in 56" x 29" x 77" (**Model #1309 & Model #1309G**). All parts come in one (1) box only. Please pay particular attention to make sure all parts are numbered and graphically indexed, so does the quantity for each part as per the Parts List below. If you need any help, please **EMAIL the support team** at your earliest convenience with **the order number, required part(s), quantity for each part, and photos (or video clips, if applicable)**, we'll get back soon to help out.

Part Number	Diagram	Description	Quantity (PCS)
#1		Pole (30.3")	4
#2		Pole (26.8")	15
#3		Pole (22.4")	16
#4		Pole (11")	20
#5		Pole with Curved End	4
#A		90-Degree 3-Way Connector	6
#B		T-Shaped 3-Way Connector	4
#D		4-Way Connector	18

Part Number	Diagram	Description	Quantity (PCS)
#E		5-Way Connector	2
#G		120-Degree 3-Way Connector	2
#I		Short Steel Shelf	6
#J		Cover	1
#K		Long Steel Shelf	1
#L		Stake	8
#M		Rope	4
#N		T-Shaped Plant Tag	50
#O		S-Shaped Hook	10
#P		Cable Tie	30

Assembly

Read Before the Assembly

- ✓ Check to make sure that you have all parts listed on the **Parts Lists**.
- ✓ Before moving to the next step, please make sure the end of the poles are aligned with the bottom of the connectors, which indicates that the pipes are fully seated inside the connectors.

Step 1 Start from the bottom (first tier) by connecting the poles with connectors. You'll use:

- 2 x Part #1
- 4 x Part #2
- 8 x Part #3
- 4 x Part #4
- 4 x Part #A
- 4 x Part #D

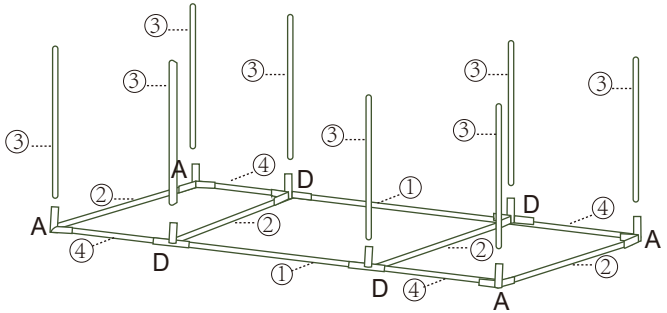

IMPORTANT! Please recheck to make sure each part is tightly connected.

Step 2 Let's move to the second tier. You'll need:

- 4 x Part #2
- 8 x Part #3
- 4 x Part #4
- 8 x Part #D

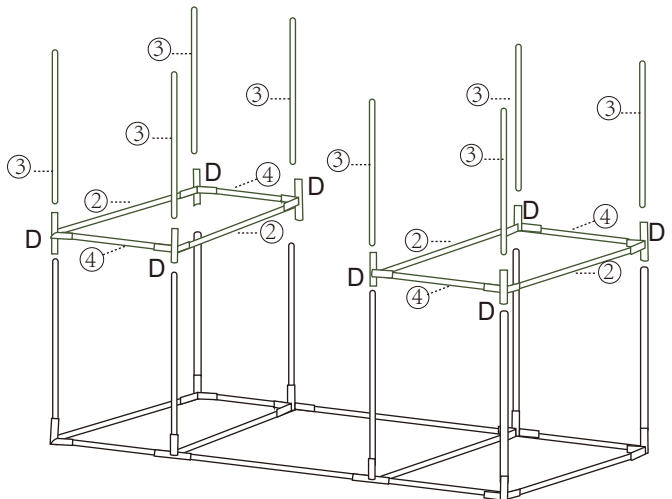

IMPORTANT! Please recheck to make sure each part is tightly connected.

Step 3 To assemble the third tier, please use:

- 1 x Part # 1
- 4 x Part #2
- 10 x Part #4
- 2 x Part #A
- 4 x Part #D
- 2 x Part #E

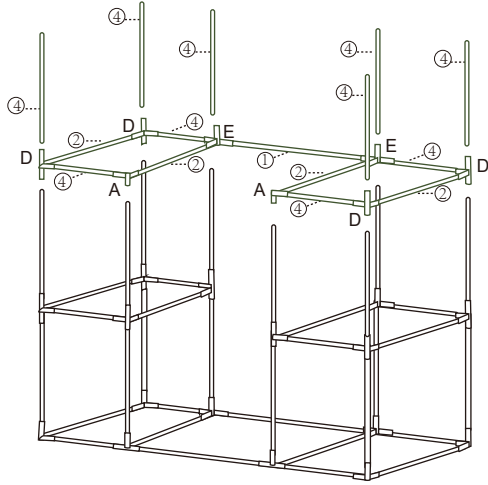

IMPORTANT! Please recheck to make sure each part is tightly connected.

Step 4 Now we can assemble the roof with:

- 1 x Part #1
- 3 x Part #2
- 2 x Part #4
- 4 x Part #5
- 4 x Part #B
- 2 x Part #D
- 2 x Part #G

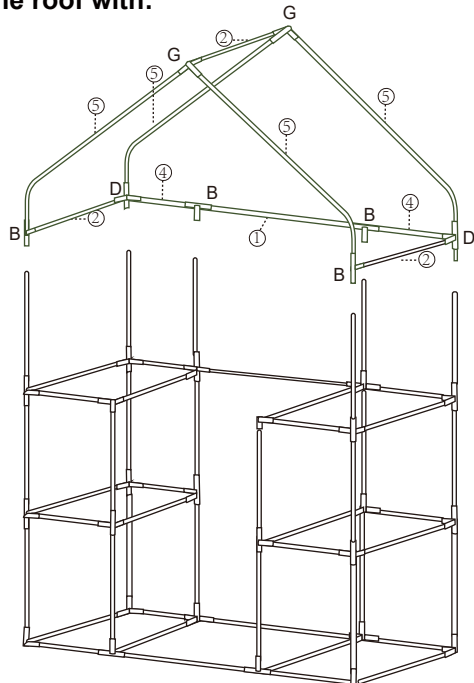

IMPORTANT! Please recheck to make sure each part is tightly connected.

Step 5 Put the Short Steel Shelf (#I) and the Long Steel Shelf (#K) in the respective tier with the Cable Tie (#P), then put on the Cover (#J).

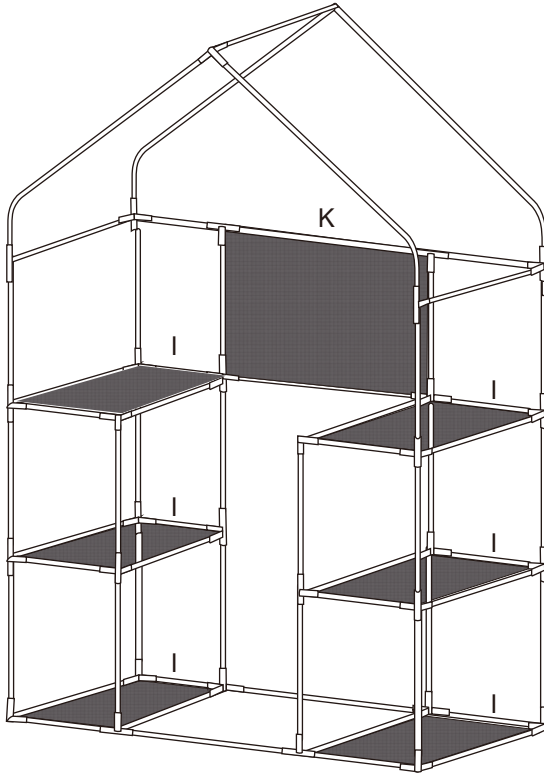

NOTICE!

To avoid the tip-over of the structure when using it, please:

- Place the heavy items on the bottom to weigh down the greenhouse.
- Keep a balance of the weight on shelves of both sides.

Secure the Greenhouse

The Stakes (#L) and Ropes (#M) are included for each greenhouse. You can use them together or use the stakes only to secure the structure.

Method 1 Use the Stakes and Ropes together. Tie the ropes to the frame and fix the other end of each to the ground with stakes.

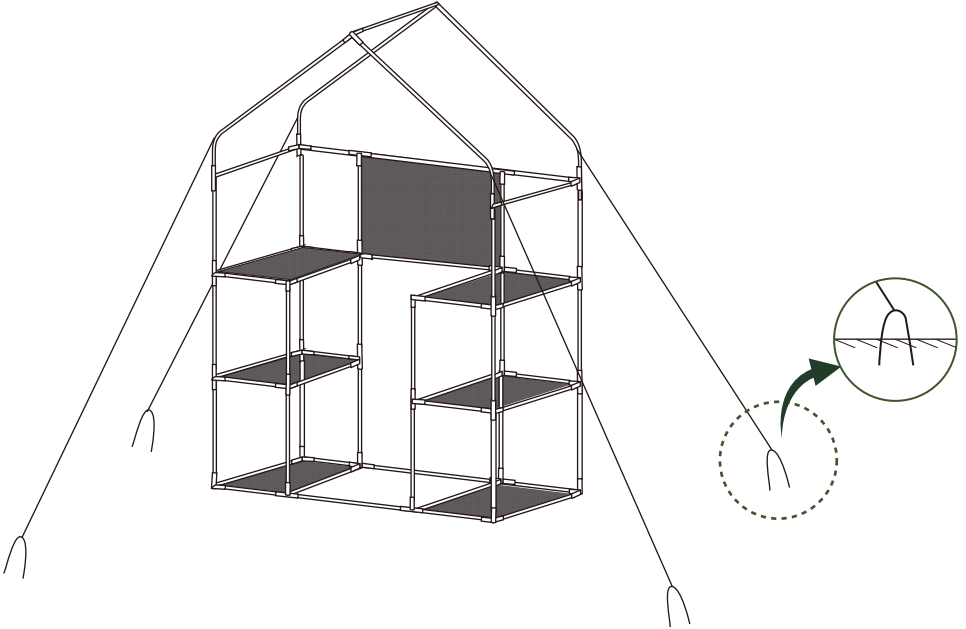

Method 2 Use the Stakes. Fix the bottom of the frame with stakes. It works well in preventing the frame from deforming.

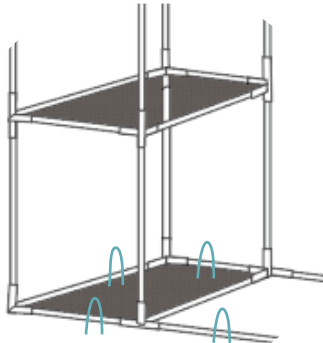

56" x 56" x 77"



Model #1317W with a Clear PVC Cover









Model #1317G with a Green PE Cover













IMPORTANT!

- The two models in this size (**Model #1317W & Model #1317G**) are the SAME except for the **COVER (#J)**.
- Model #1317W has a clear PVC cover.
- Model #1317G has a green PE cover.

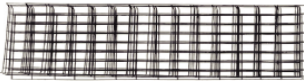
Parts List

Please refer to this chapter if you're owning a Quiccent mini greenhouse in 56" x 56" x 77" (**Model 1317W & Model #1317G**). All parts come in one (1) box only. Please pay particular attention to make sure all parts are numbered and graphically indexed, so does the quantity for each part as per the Parts List below. If you need any help, please **EMAIL the support team** at your earliest convenience with **the order number, required part(s), quantity for each part, and photos (or video clips, if applicable)**, we'll get back soon to help out.

Part Number	Diagram	Description	Quantity (PCS)
#1		Pole (30.3")	4
#2		Pole (26.8")	30
#3		Pole (22.4")	24
#4		Pole (11")	28
#5		Pole with Curved End	6
#A		90-Degree 3-Way Connector	6
#B		T-Shaped 3-Way Connector	4
#C		X-Shaped 4-Way Connector	2

Part Number	Diagram	Description	Quantity (PCS)
#D		4-Way Connector	24
#E		5-Way Connector	8
#G		120-Degree 3-Way Connector	2
#H		Curved 4-Way Connector	1
#I		Short Steel Shelf	12
#J		Cover	1
#K		Long Steel Shelf	1
#L		Stake	10
#M		Rope	4
#N		T-Shaped Plant Tag	50
#O		S-Shaped Hook	10
#P		Cable Tie	40

Assembly

Read Before the Assembly

- ✓ Check to make sure that you have all parts listed on the **Parts Lists**.
- ✓ Before moving to the next step, please make sure the end of the poles are aligned with the bottom of the connectors, which indicates that the pipes are fully seated inside the connectors.

Step 1 Start from the bottom (first tier) by connecting the poles with connectors. You'll use:

- 2 x Part #1
- 8 x Part #2
- 12 x Part #3
- 6 x Part #4
- 4 x Part #A
- 8 x Part #D

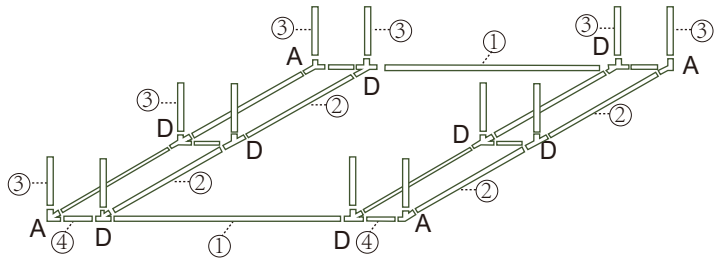

IMPORTANT! Please recheck to make sure each part is tightly connected.

Step 2 Let's move to the second tier. You'll need:

- 8 x Part #2
- 12 x Part #3
- 6 x Part #4
- 8 x Part #D
- 4 x Part #E

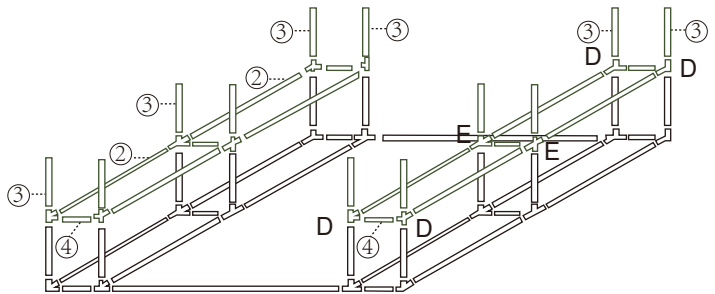

IMPORTANT! Please recheck to make sure each part is tightly connected.

Step 3 To assemble the third tier, please use:

- 1 x Part #1
- 8 x Part #2
- 14 x Part #4
- 2 x Part #A
- 6 x Part #D
- 4 x Part #E

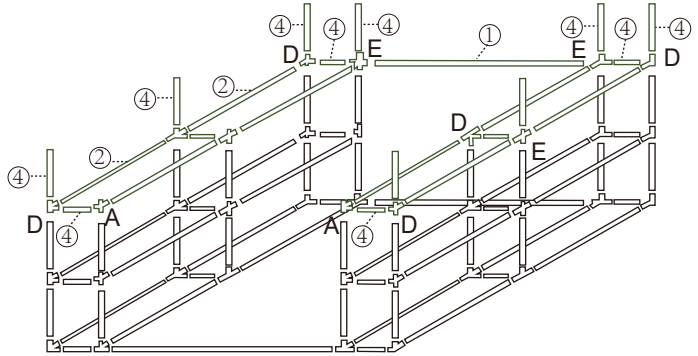

IMPORTANT! Please recheck to make sure each part is tightly connected.

Step 4 Now we can assemble the roof with:

- 1 x Part #1
- 6 x Part #2
- 2 x Part #4
- 6 x Part #5
- 4 x Part #B
- 2 x Part #C
- 2 x Part #D
- 2 x Part #G
- 1 x Part #H

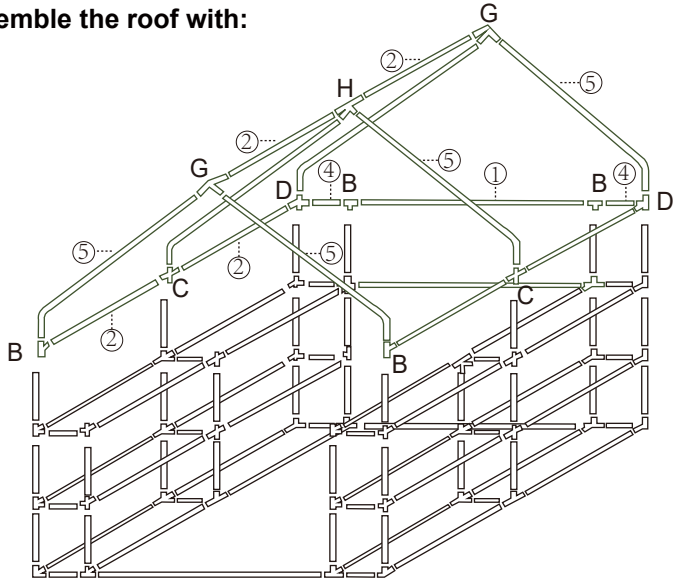

IMPORTANT! Please recheck to make sure each part is tightly connected.

Step 5 Put the Short Steel Shelf (#I) and the Long Steel Shelf (#K) in the respective tier with Cable Ties (#P), then put on the Cover (#J).

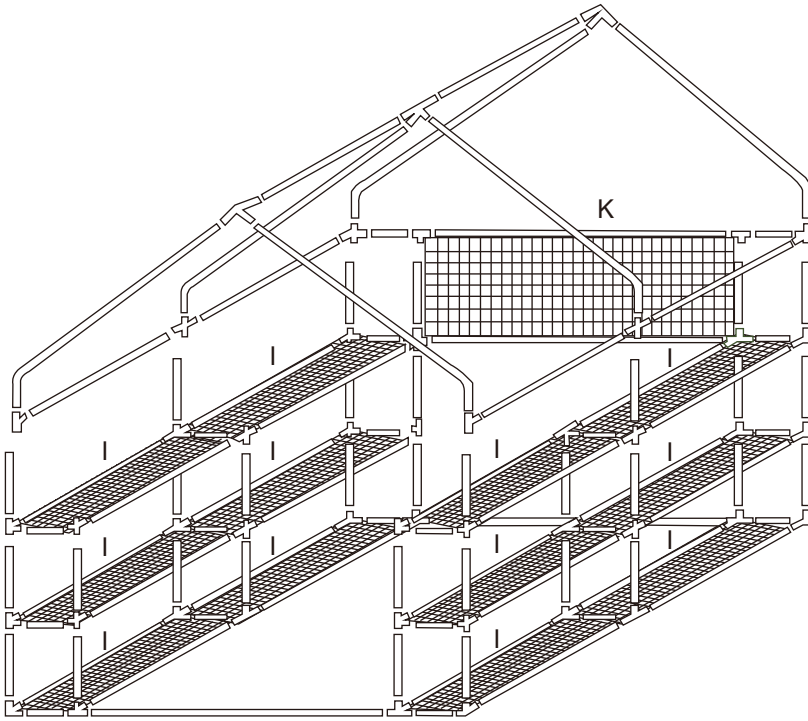

NOTICE!

To avoid the tip-over of the structure when using it, please:

- Place the heavy items on the bottom.
- Keep a balance of the weight on shelves of both sides.

Secure the Greenhouse

The Stakes (#L) and Ropes (#M) are included for each greenhouse. You can use them together or use the stakes only to secure the structure.

Method 1 Use the Stakes and Ropes together. Tie the ropes to the frame and fix the other end of each to the ground with stakes.

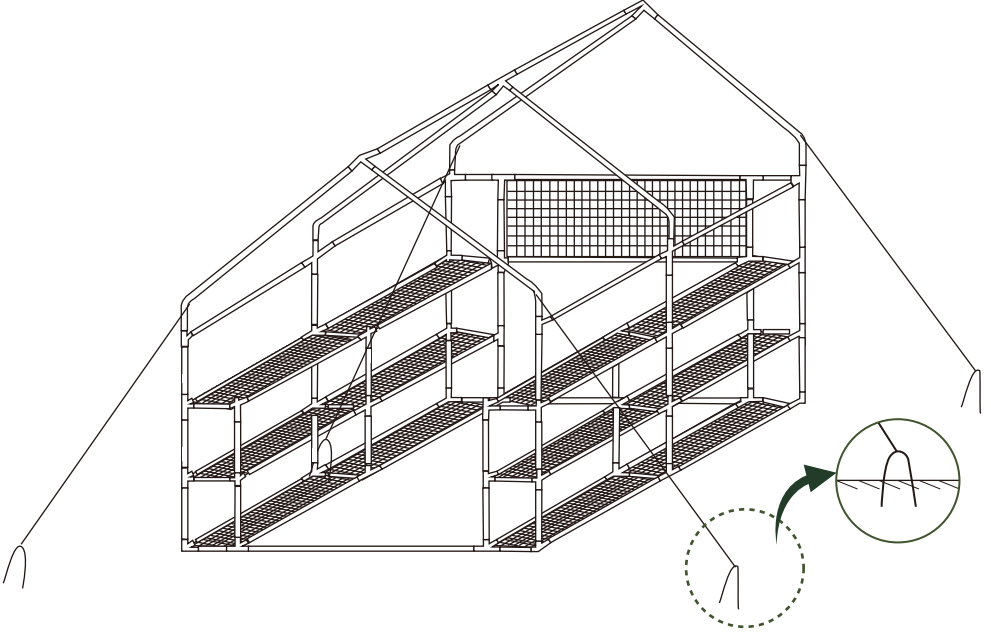

Method 2 Use the Stakes. Fix the bottom of the frame with stakes. It works well in preventing the frame from deforming.

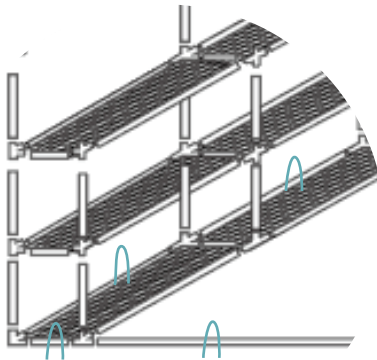

Maintenance

To help you maintain your mini greenhouse in optimal condition and for longer service life, please refer to our suggestions below:

- Please secure the cover at all times by tying all the ropes inside and fixing the extended part with extra weights (soil, bricks, stones, sandbags, etc.)
- Please close the windows and doors whenever ventilation is not required.
- Please move the structure and plants indoors or to somewhere that is sheltered in bad weather (storms, windy days, hurricanes, tornadoes, etc.)
- Please clean up snow in time if you use the structure in winter, or it would collapse due to overloading.
- Please understand that the local weather influences the performance. You could apply other equipment if higher temperatures are required.

Warranty

The limited warranty covering the materials and the craftsmanship under normal use and service conditions takes effect from the purchase date (according to the **Purchase History**):

- A 365-day warranty for the **Frame Poles**.
- A 180-day warranty for the **Cover**.
- A lifetime warranty for other parts not mentioned above.

We also provide a great discount for our regular customers when they purchase replacement parts after the warranty expires.

Please note that the purchase proof of order (order number or shipping information on the shipping carton) is the only valid evidence to claim for warranty.

REMINDERS

1. Please note that the purchase proof of order (order number or shipping information on the shipping carton) is the only valid evidence to claim for warranty.
2. To get what you need as soon as possible, we strongly suggest you provide all of the following information **at your first inquiry**:
 - Order number
 - Part number
 - Quantity required for each part
 - Pictures (or video clips, if applicable)

WARNING

- Restructuring the product without written permission from Quiccent in advance would **VOID** the warranty.
- Damages due to improper use in severe weather conditions, including but not limited to high winds, heavy rain, sleet, snow, etc., will NOT be covered by the warranty.

Quictent

SHELTERS FOR MOST PEOPLE



QT-MINI-GH-202101