

Truck Tent

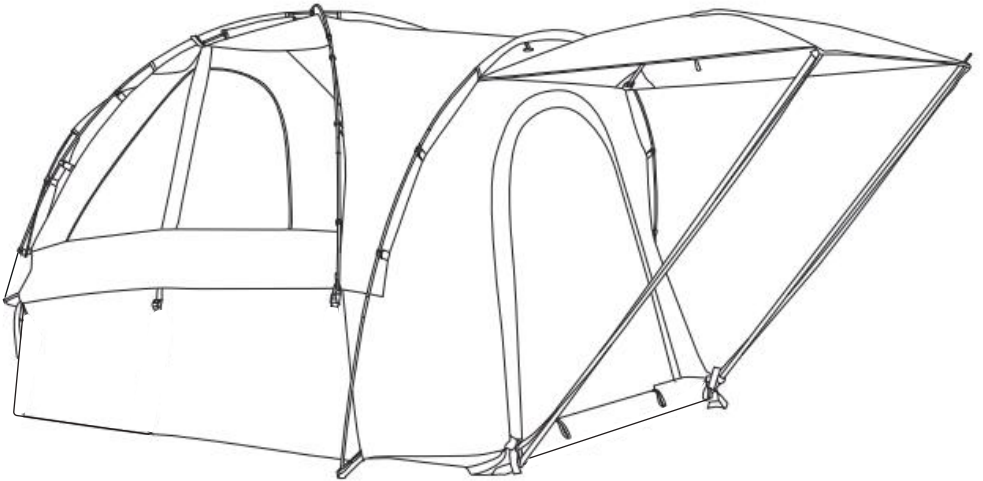

Full Size Short Bed (5.5'-5.8')

Compact Regular Bed (6'-6.3')

Full Size Regular Bed (6.4'-6.7')

Full Size Long Bed (8' -8.2')

Compact Short Bed (5'-5.2')

Please read, understand, and practice the guidelines in this user manual before use, and keep it for future reference.

Table of Contents

- About Quiccent 2
- Safety Instruction 3
- Parts List 4
- Assembly Steps 6
- Maintenance 11
- Warranty 11

IMPORTANT

We'd love to hear from our customers. If you have any questions about the manual, our products, our service, or would like us to help in any way, please feel free to contact the support team. We will reply in 12 hours (business days).

This user manual applies to Quiccent truck tents. It will help you to get to know your Quiccent truck tent. Please read the guidelines in this manual and keep the manual for future reference.

We may update the manual without notice in advance. You can always search “**Quiccent Instructions**” online for the latest version.

About Quiccent

Founded in the early 21st century, Quiccent has grown into a popular brand with reliable products and excellent customer service during the past decades. We started with pop up canopies, and then expanded to other more categories of shelters and the like including party tents, carports, greenhouses, garden beds, grow tents, shade sails, patio umbrellas and RV covers. Driven by the vision to create unique spaces to meet every specific need and become a part of America's landscape, we at Quiccent would spare no effort to keep innovating.

Our Vision

To create unique spaces to meet every specific need, and become a part of America's landscape.

Our Mission

To keep innovating and provide a wide range of reliable shelters and shades at consumer-grade prices with customer-first service.

Our Service

The customer-centric service is what we at Quiccent take great pride in. In addition to the hassle-free warranty covering all Quiccent products, an industrial-leading support team is standing behind at all times. Whenever you need help or have any suggestions and comments, do not hesitate to contact our support team. You're sure to get a to-the-point reply in 12 hours.

Safety Instruction

You should read, understand, and practice safety instructions in this chapter. For any damages due to not obeying guidelines as instructed, the owner (user) should take full responsibility.

Campsite Selection

Choosing a proper campsite is of top importance in terms of safety. Please:

- Select a smooth, level campsite clear of rocks, branches, and other hard or sharp objects.
- Avoid areas with overhead power lines and tree limbs.
- Park the vehicle at the chosen campsite.

Fire Caution

You should always keep all flame and heat sources away from the tent fabric. Please:

- Build campfires downwind and several meters away from the tent.
- Be sure to fully extinguish fires before resting or leaving a campsite.
- Do **NOT** use candles, matches, or open flames of any kind in or near the tent.
- Do **NOT** smoke, cook, or refuel lamps, heaters, or stoves inside the tent. Use battery-operated lanterns whenever possible.

For your safety, please also keep the following two guidelines in mind at all times:

- Make sure the engine is off and the exhaust is fully cooled before installing and using the tent. Never run the vehicle engine when the tent is attached.
- Close the doors and windows to get rid of flying, mosquitoes, and any other unwanted small animals at night.

Parts List

You'll receive one (1) box for this model. Please pay particular attention to making sure all parts are graphically indexed as shown on the **Parts List**, so does the quantity for each part. If you need any help, please contact us promptly with the **ORDER NUMBER, REQUIRED PARTS (NAME, QUANTITY, and PART NUMBER), PICTURES (OR VIDEO CLIPS, IF APPLICABLE)**, we'll get back to help out soon.

- The poles numbered from #A - #E are for the tent frame.
- The poles (#F & #G) are used to support the awning.

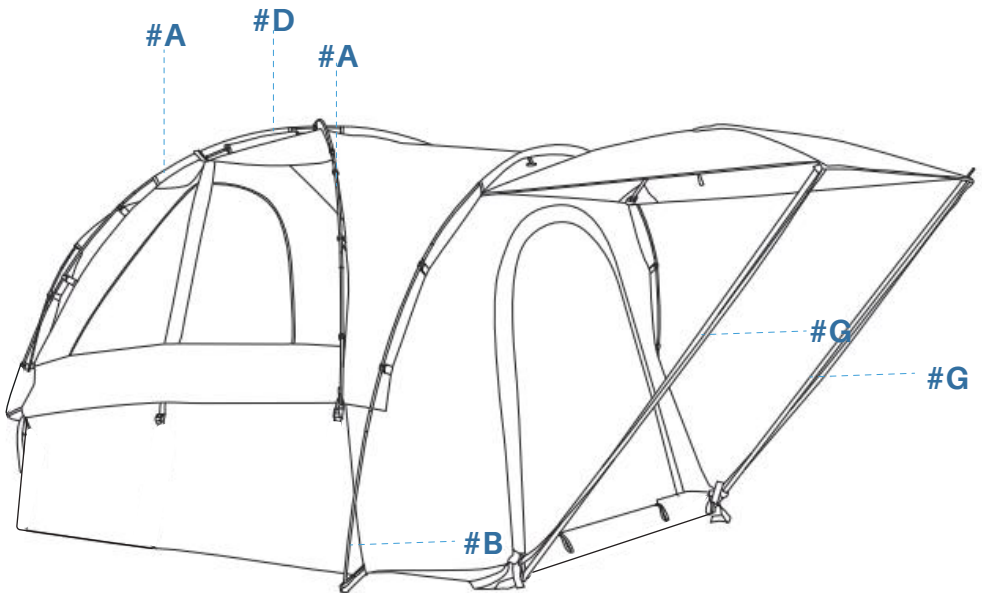

Parts List

Part Number	Diagram	Description	Quantity (PCS)
#A		Blue Tent Pole	2
#B		Yellow Tent Pole	1
#C		Black Tent Pole	1
#D		Green Tent Pole	1
#E		Red Tent Pole	1
#F		White Top Awning Pole	2
#G		Side Awning Arm	2
#H		Tent Fabric	1
#I		Rainfly	1
#J		Carry Bag	1
#K		Strap	12

Assembly Steps

For an easier assembly, we highly recommend you **finish assembling the tent frame (Step 1 - Step 3) and the awning ceiling (Step 4) on the ground**, then move the structure to your vehicle (Step 5 & Step 6) for the following assembly steps (Step 7 & Step 8).

REMINDERS!

- Before the assembly, please check to make sure that you have all parts listed on the **Parts List**.
- Please be careful and do **NOT** create too much tension during the assembly, or it may cause poles to break.
- We recommend at least two adults for the assembly.

Step 1. Layout the Tent Fabric (#H) and insert the tent poles (2 x #A, 1 x #B, 1 x #D, and 1 x #E) into the corresponding color sleeve as shown.

Notes

- You need to unfold each section of the tent poles before using them.
- You do **NOT** need to place the poles in the corner pockets in this step.
- Please do **NOT** force the tent poles if they get stuck – gently guide them through the sleeve.

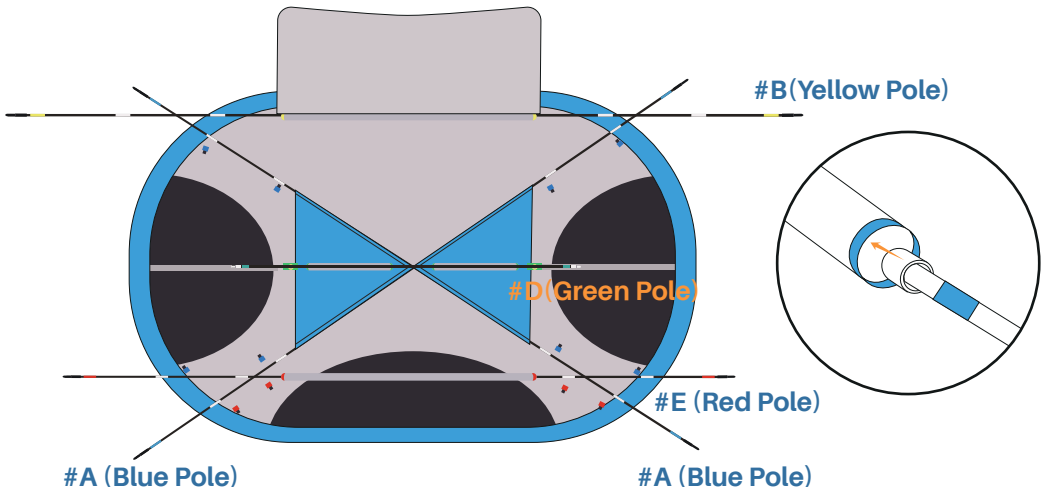

Step 2. Insert each pole into the corresponding colored pocket in the following order: the first comes to the Tent Poles (#A, blue), then the Tent Pole (#B, yellow) and the Tent Pole (#E, red), and finally the green one (#D).

Note: 1. Please secure all the poles with the clips after you properly place them.

2. Please fix the Tent Poles (#A, blue) and Tent Pole (#D, green) with built-in straps.

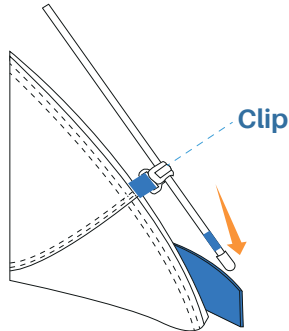

Step 3. Reinforce the tent frame with the Tent Pole (#C, black) from inside. There are three (3) reminders:

- To keep the tent clean, please take off your shoes before entering it.
- The black pole (#C) should be placed OVER the Lantern Holder & Gauze Mesh.
- Please remember to secure the pole with the built-in Velcro and straps.

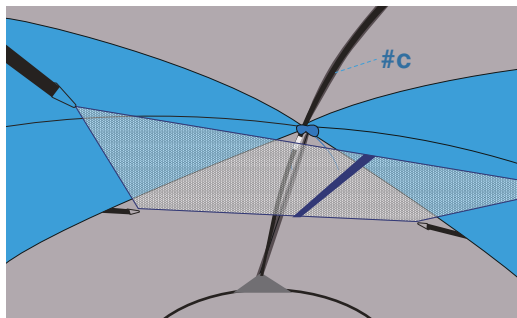
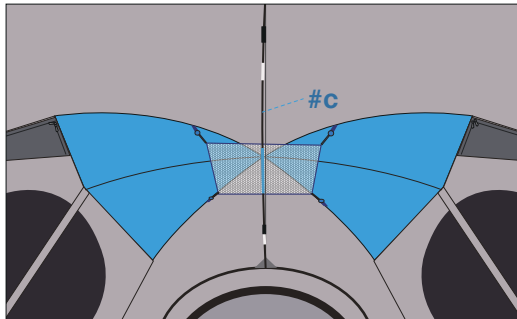

Step 4. Let's start assembling the awning. As shown, please insert the 2 x Top Awning Poles (#F) into the ceiling of the awning, forming an "X", and then fix the arms with the straps.

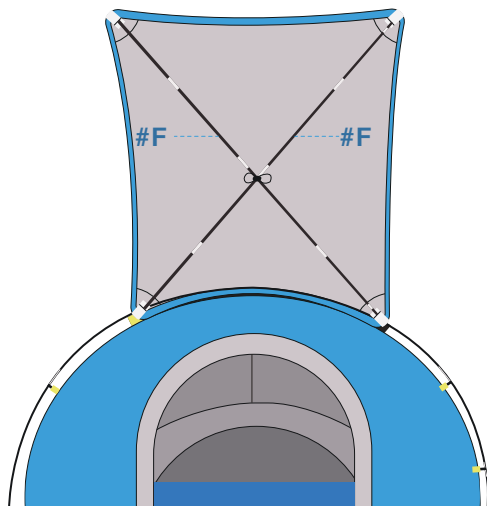

Step 5. Move the structure into your vehicle.

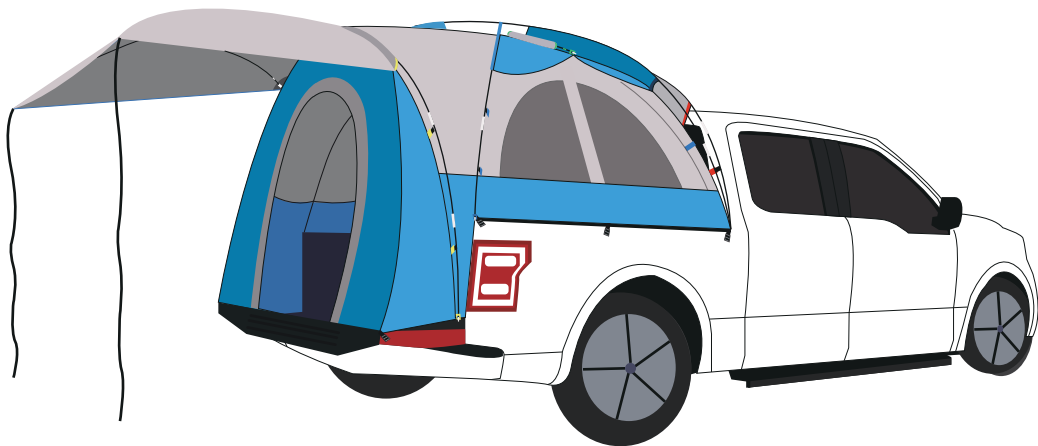

Step 6. Fix the tent to the vehicle's body with the help of the 8 x Straps (#K).

- (a) Connect one end of the arms to the top corners of the awning
- (b) Insert the other end of the arms into the corresponding metal rings.
- (c) Secure the arms with the built-in straps.
- (d) Fix the arms with the Velcro straps and the buckles. Adjust the straps till the arms are stable.

Adjust the Straps

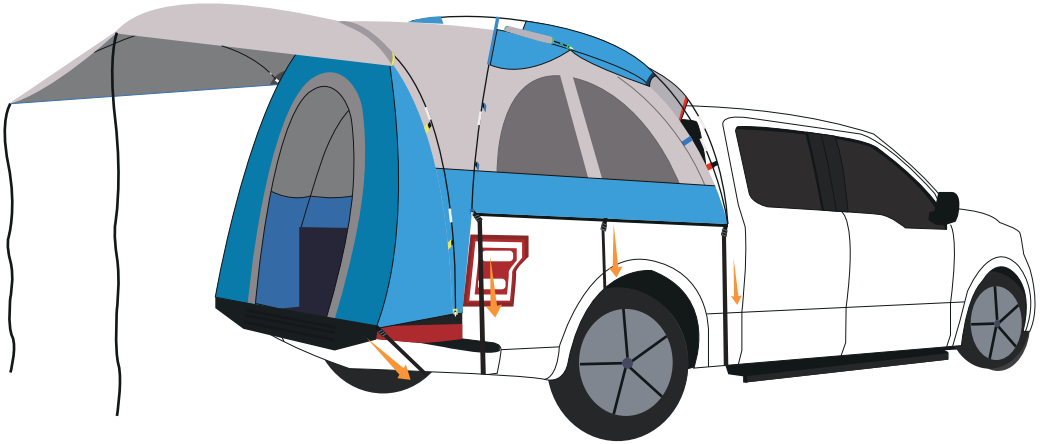
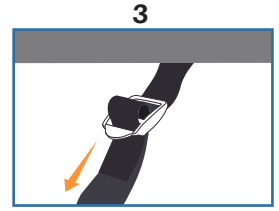
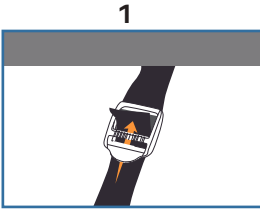

Step 7. Assemble the 2 x Awning Arms (#G).

- (a) Connect one end of the arms to the top corners of the awning.
- (b) Insert the other end of the arms into the corresponding metal rings.
- (c) Secure the arms with the built-in straps.
- (d) Fix the arms with the Velcro straps and the buckles. Adjust the straps till the arms are stable.

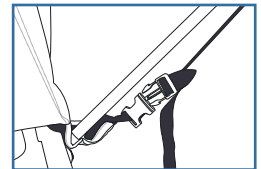
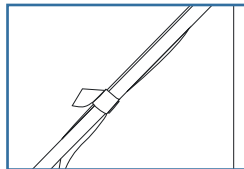
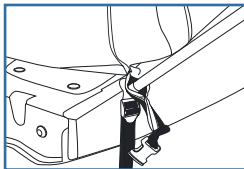
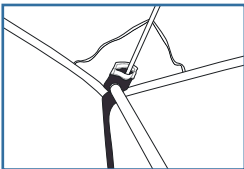

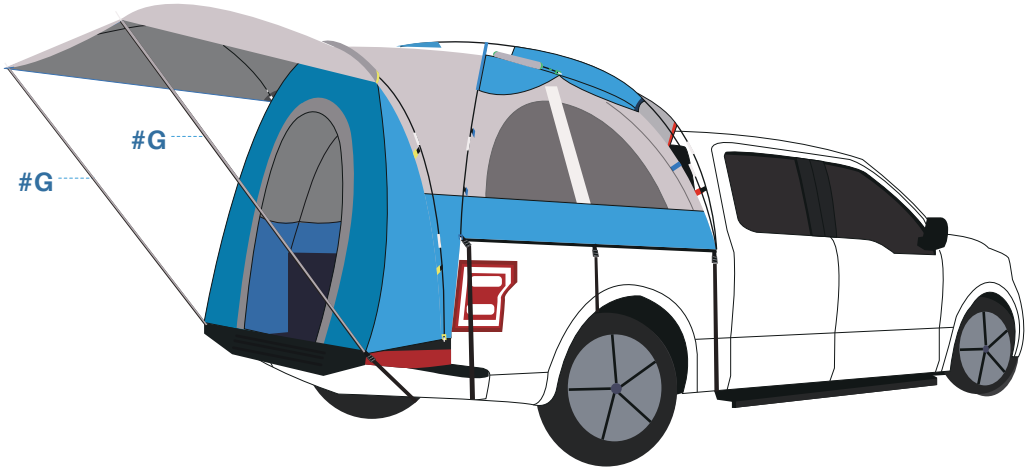

Step 8. (It's optional!) Attach the Rainfly (#I).

(a) Drape the Rainfly (#I) over the tent. Please note that the **zipper of the rainfly should be close to the tailgate** of your vehicle.

(b) Secure the Rainfly (#I) with Velcro and 4 x Straps (#K).

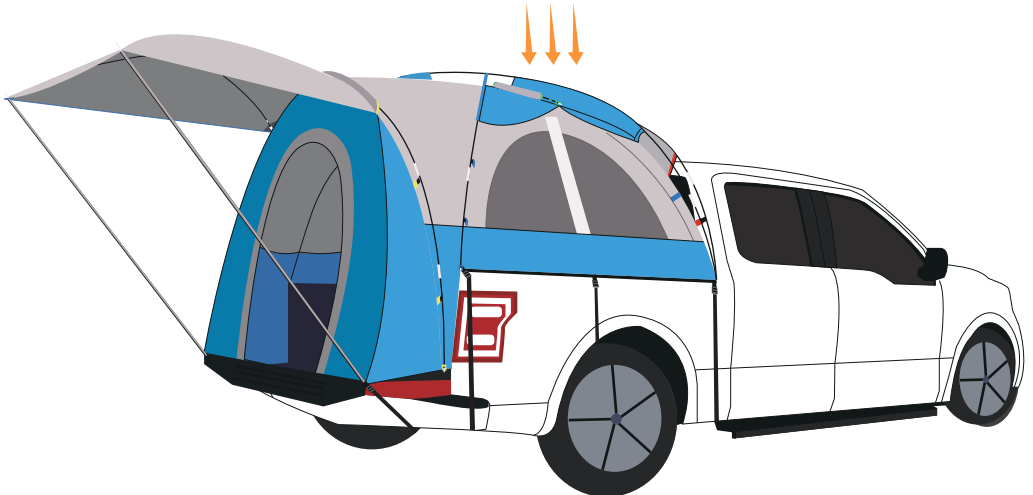
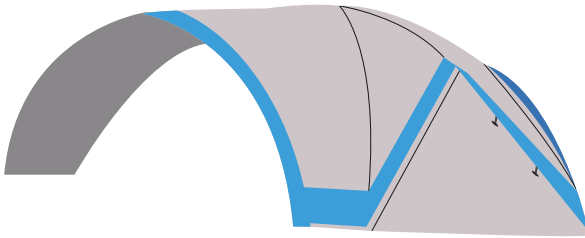

Maintenance

For longer service life and to help you maintain your truck tent in optimal condition, please refer to our suggestions below.

- Do not forcibly twist all the poles.
- Please roll up the awning when not in use.
- Please clean and dry the tent before storing it.
- Please allow adequate ventilation inside the tent at all times.
- Please keep all the parts in the carry bag and store the bag in a cool, dry place.

Warranty

The **24-month** limited warranty covering the materials and the craftsmanship under normal use and service conditions takes effect from the purchase date (on the invoice). Please note that the order purchase proof (order number or shipping information on the shipping carton) is the only valid evidence to claim for warranty.

REMINDERS!

1. In the event that you failed to access your order information online, we strongly advise you to keep the original packaging and shipping carton(s) because they are treated as a proof of purchase.

2. To get what you need as soon as possible, we strongly suggest you provide all of the following information **at your first inquiry**:

- Order number
- Required parts (name, quantity, and part number)
- Quantity required for each part
- Pictures (or video clips, if applicable)

WARNING

- Restructuring the product without written permission from Quicent in advance would **VOID** the warranty.
- Damages due to improper use in severe weather conditions, including but **NOT** limited to high winds, heavy rain, sleet, snow, etc., will **NOT** be covered by the warranty.

