



User Manual

for Quicktent Party Tent



Please read, understand, and practice the guidelines in this user manual before use, and keep it for future reference.

20' x 14.5' (Octagonal) 29' x 21' (Decagonal)

The **Parts List** varies by the model. Please refer to the correct list according to the product you have.

Table of Contents

- About QuicTent 3
- Safety Instructions 3
- 20' x 14.5' Octagonal Party Tent (Model #GM1407) 5
- 29' x 21' Decagonal Party Tent (Model #GM5502) 10
- Maintenance 16
- Warranty 16
- Appendix 18

IMPORTANT

We'd love to hear from our customers. If you have any questions about our products, the manual, or would like us to help in any way, please feel free to contact the support team. We will reply in 12 hours (business days).

- Check **the Spam** and your **email Settings** if you do not receive a reply in time as it is probably blocked because our support team will always get back to you no later than the timeframe.
- Add the following email address to your CONTACT LIST in case of any blocking.
- **Email: sales@quictents.com, maxlead.us@gmail.com.**

This user manual applies to Quicent big party tents. It will help you to get to know your Quicent big party tents. Please read the guidelines in this manual and keep the manual for future reference.

We may update the manual without notice in advance. You can always search "**Quicent Instructions**" online for the latest version.

About Quicent

Founded in the early 21st century, Quicent has grown into a popular brand with reliable products and excellent customer service during the past decades. We started with pop up canopies, and then expanded to other more categories of shelters and the like including party tents, carports, green-houses, garden beds, grow tents, shade sails, patio umbrellas and RV covers. Driven by the vision to create unique spaces to meet every specific need and become a part of America's landscape, we at Quicent would spare no effort to keep innovating.

Our Vision

To create unique spaces to meet every specific need, and become a part of America's landscape.

Our Mission

To keep innovating and provide a wide range of reliable shelters and shades at consumer-grade prices with customer-first service.

Our Service

The customer-centric service is what we at Quicent take great pride in. In addition to the hassle-free warranty covering all Quicent products, an industrial-leading support team is standing behind at all times. Whenever you need help or have any suggestions and comments, do not hesitate to reach us via **sales@quicents.com** or **maxlead.us@gmail.com**. You're sure to get a to-the-point reply in 12 hours.

Safety Instructions

You should read, understand, and practice safety instructions in this chapter. For any damages due to not obeying guidelines as instructed, the owner (user) should take full responsibility.

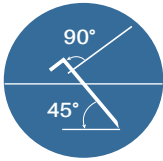

Do NOT insert the L-shaped pegs and the Auger Anchors vertically. Always form an angle with the ground (As shown, a 45-degree is the best position).



Do NOT leave a tent outdoors too long as it's designed to be used as a temporary structure.



Do NOT leave a tent unattended overnight.



Do NOT light a fire inside the party tents. Keep open flames, flammable materials, and any heat source away from your Quic Tent party tents.

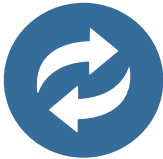

Do NOT throw away the original packaging cartons in case of a return or an exchange.



You can ALWAYS contact the support team for replacement parts whenever in need.

Reminder

Do not use and leave the structure outside in inclement weather. The owner (or user) should take down the structure for any potential inclement weather, including high winds, heavy rain, sleet, snow, and the like, or he (she) should take the loss.



Warning

- Stop using the party tent immediately if any damage is found, or Quic Tent will not be liable for any loss thereafter.
- Please do NOT place heavy objects on the top of a Quic Tent party tent, or leave it outside overnight because it's designed to be used as a temporary structure.

20' x 14.5' Octagonal Party Tent

Parts List (Model #GM1407)

You'll receive **three (3) boxes** for this model. You can identify the packages by referring to **(Table B)** below. Please also pay particular attention to making sure all parts are numbered and graphically indexed as shown on the **Parts List (Table A)**, so does the quantity for each part. If you need any help, please contact us promptly (sales@quicktents.com or maxlead.us@gmail.com) with the **ORDER NUMBER, REQUIRED PARTS (NAME, QUANTITY, and PART NUMBER)**, PICTURES (OR VIDEO CLIPS, IF APPLICABLE), we'll get back to help out soon.

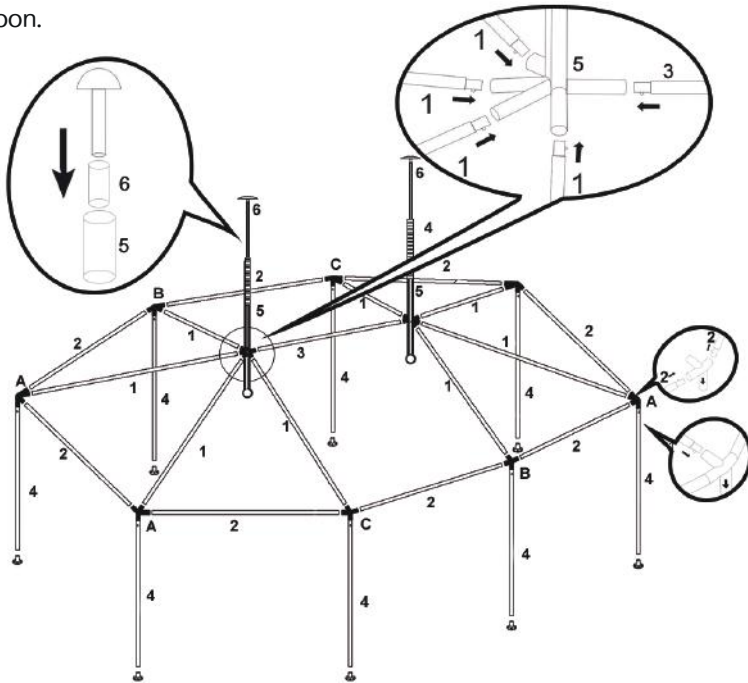

Table A. Parts List

Part Number	Diagram	Description	Quantity (PCS)
#1		Steel Pole (7.0ft)	8
#2		Steel Pole (6.7ft)	8
#3		Steel Pole (6.8ft)	1
#4		Steel Pole (6.3ft)	8

Table A. Parts List



















Part Number	Diagram	Description	Quantity (PCS)
#5		Steel Pole (2.1ft)	2
#6		Steel Pole (2.0ft)	2
#A		Three Way Connector	4
#B		Three Way Connector	2
#C		Three Way Connector	2
#D		Five Way Connector	2
#E		Foot Base	8
#F		Roof Cover	1
#G		Window Sidewall	2
#H		Zipper Sidewall	2
#I		Top Support Plate	2
#J		32*300 Spring	2
#K		Auger Anchor	8
#L		Rope	8
#M		Bungee Cord	24
#K		L-Shaped Peg	16
#L		M8*50 Screw for Pole #4	8
#M		M6*50 mm Screw for Pole #5 & #D	2

Table B. Package Contents for Shipping Cartons

Part Number	Parts Included
Box #1	8 x Part #1 (Steel Pole) 8 x Part #2 (Steel Pole) 1 x Part #3 (Steel Pole) 2 x Part #6 (Steel Pole)
Box #2	8 x Part #4 (Steel Pole) 2 x Part #5 (Steel Pole)
Box #3	All the Connectors & Other Accessories not Mentioned in this Table

Step 3 Assemble the mainframe.

- a) Attach the Roof Cover (#F) to the assembled top frame with Bungee Cords (#M) .
- b) Connect the 8 x poles (#4) to the connectors (#A, #B, and #C) on the top frame.

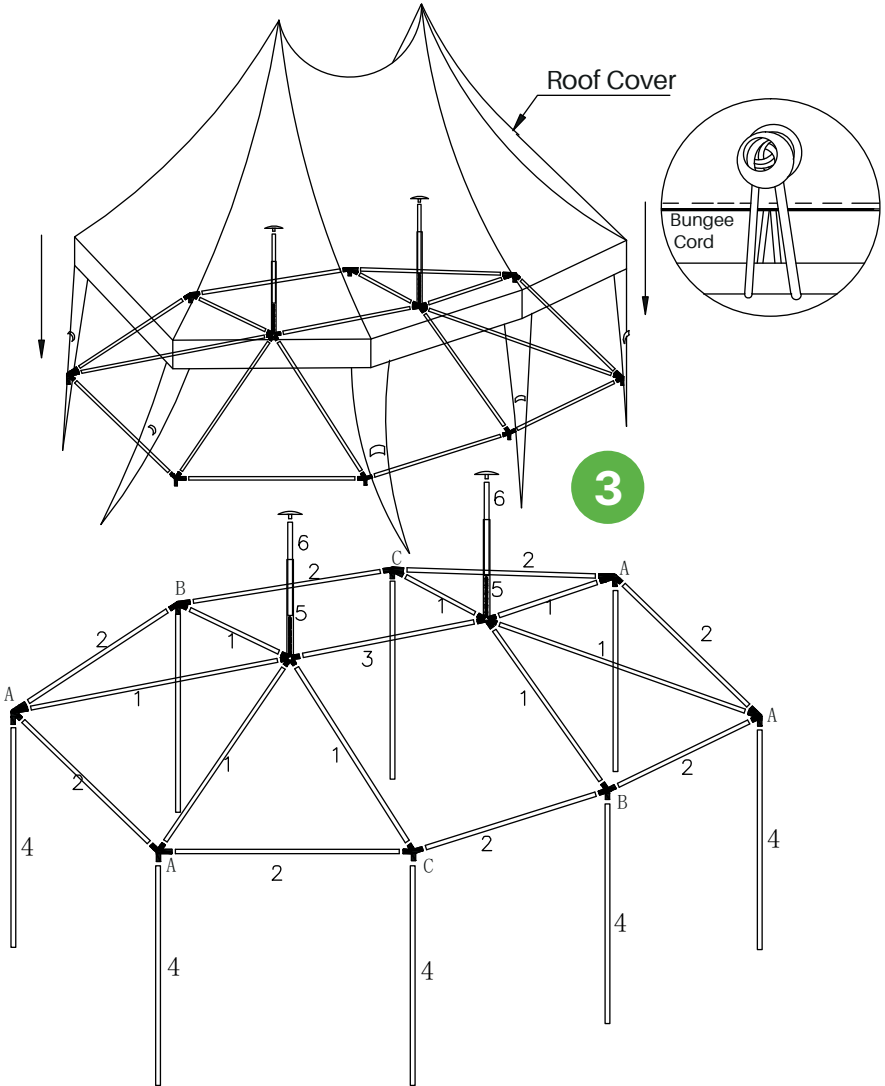

Step 4 Secure the mainframe.

- a) Tighten/loosen the leg covers (attached to the roof cover) by placing their hook on a proper adjusting hole on the poles (#4).
- b) Connect a Foot Base (#E) to the bottom of each pole (#4) and fix them together with M8×50 Screws (#O).
- c) Fix the Foot Bases (#E) to the ground by inserting the L-Shaped Pegs (#N) into their pre-drilled holes. You can insert two pegs for each foot base as there are 16 pieces of pegs in total.

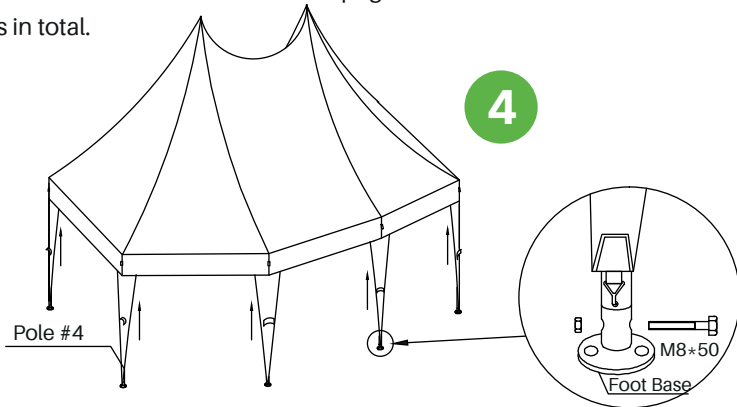

Step 5 Attach the 2 x Window Sidewalls (#G) and the 2 x Zippers Doors (#H) and secure the whole structure.

- a) Fix the fabric to the top frame and the mainframe by wrapping up their built-in Velcro straps.
- b) Secure the entire structure with the 8 x Ropes (#L) and the 8 x Auger Anchors (#K). To secure the tent better, it is highly recommended that you insert the anchors diagonally into the ground. As shown, a 45-degree to the ground is the best position.

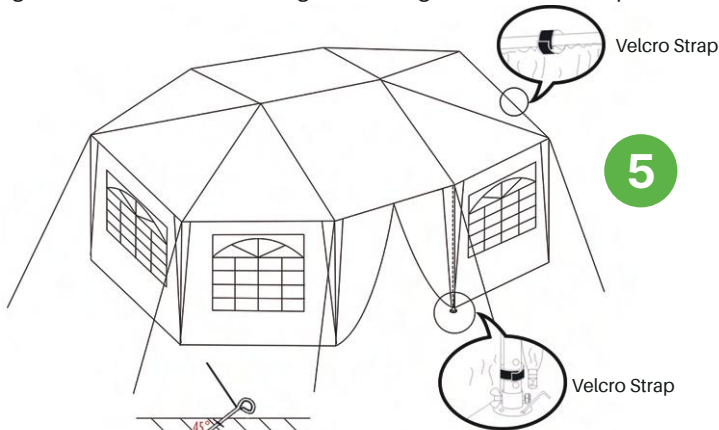

29' x 21' Decagonal Party Tent

Parts List (Model #GM5502)

You'll receive four (4) boxes for this model (**Model #GM5502**). Please check to identify the packages by referring to **Table B** below. Pay particular attention to make sure all parts are numbered and graphically indexed as shown on the **Parts List (Table A)**, so does the quantity for each part. If you need any help, please contact us promptly (sales@quictents.com or maxlead.us@gmail.com) with **the order number, required part(s), quantity for each part, and photos** (or video clips, if applicable), we will get back within 12 hours to help out.

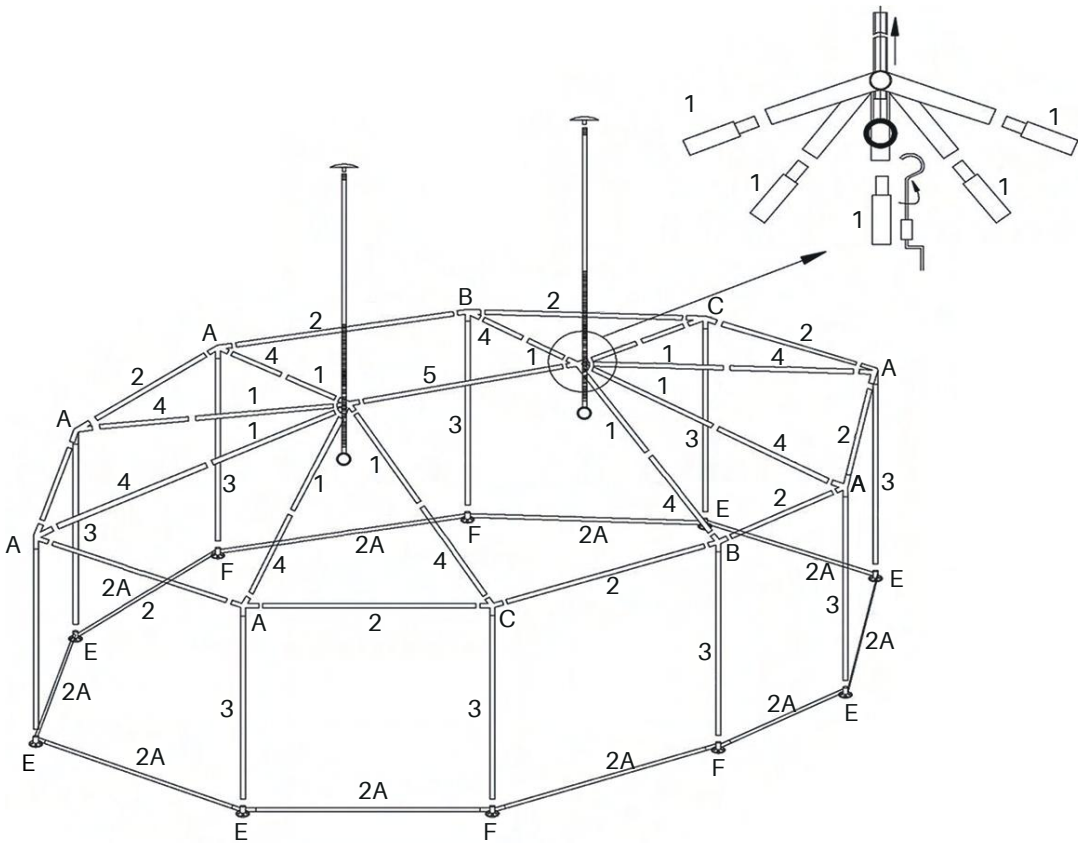

Table A. Parts List













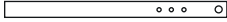









Part Number	Diagram	Description	Quantity (PCS)
#1		Steel Pole (4.1ft)	10
#2		Steel Pole (7.4ft)	10
#2A		Ground Bar (7.4ft)	10
#3		Steel Pole (6.4ft)	10
#4		Steel Pole (6.4ft)	10
#5		Steel Pole (7.4ft)	1
#A		4-Way Corner Connector	6
#B		4-Way Corner Connector	2
#C		4-Way Corner Connector	2
#D		5-Way Corner Connector	2
#E		L-Shaped Foot Base (3-Corner)	6
#F		T-Shaped Foot Base (3-Corner)	4
#G		Curtain Ring	40
#H		L-Shaped Peg	30
#I		Bolt	10
#J		Roof Cover	1
#K		Sidewall with Window	8
#L		Zipper Door	2
#M		Leg Cover	10
#N1		Top Plate	2
#N2		Top Support Pole	2
#O		Erect Hook	1
#P		Guy Rope	10
#Q		Bungee Cord	130

Table B. Package Contents for Shipping Cartons

Part Number	Parts Included
Box #1	10 x Part #1 (Steel Pole) 10 x Part #2 (Steel Pole) 1 x Part #O (Erect Hook) 2 x Part #L (Zipper Door) 2 x Part#N2 (Top Support Pole)
Box #2	10 x Pole #2A (Steel Pole) 1 x Pole #5 (Steel Pole) 8 x Part #K (Sidewalls with Window)
Box #3	10 x Part #3 (Steel Pole) 10 x Part #4 (Steel Pole)
Box #4	2 x Part #N1 (Top Plate) 1 x Part #J (Roof Cover) All the Accessories not Mentioned in this Table

Assembly

Read Before the Assembly

Please check to make sure that you have all the parts listed on the **Parts List**.

Step 1 Form the top frame as per the layout. The parts you'll use in this step are poles of 10 x #2 and connectors of 6 x #A, 2 x #B, and 2 x #C.

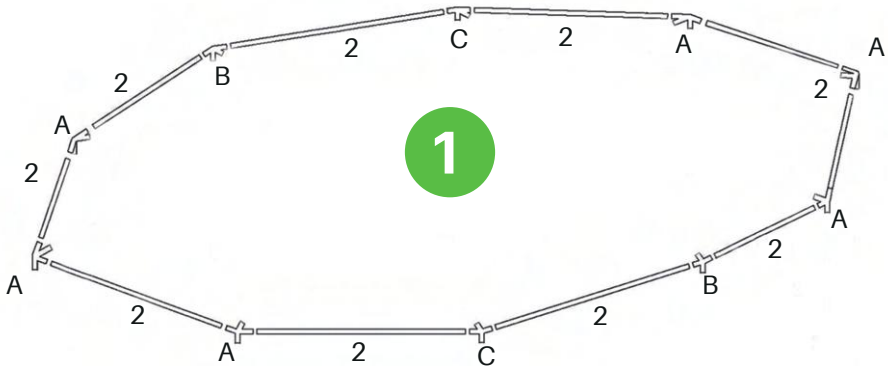

Step 2 Continue assembling the top frame by:

- Attaching one end of the poles (10 x #1 & 10 x #4) to the connectors (#A, #B, and #C).
- Attaching the other end of the poles (#1 & #4) to the connectors (2 x #D), then inserting the 2 x Top Thread Poles (#N) into the hole on the connectors (#D).

Reminder: You should set the 2 x Top Thread Poles (#H) at the lowest position at the beginning and adjust it to a proper height with the help of the Erect Hook (#O) after all work is done.

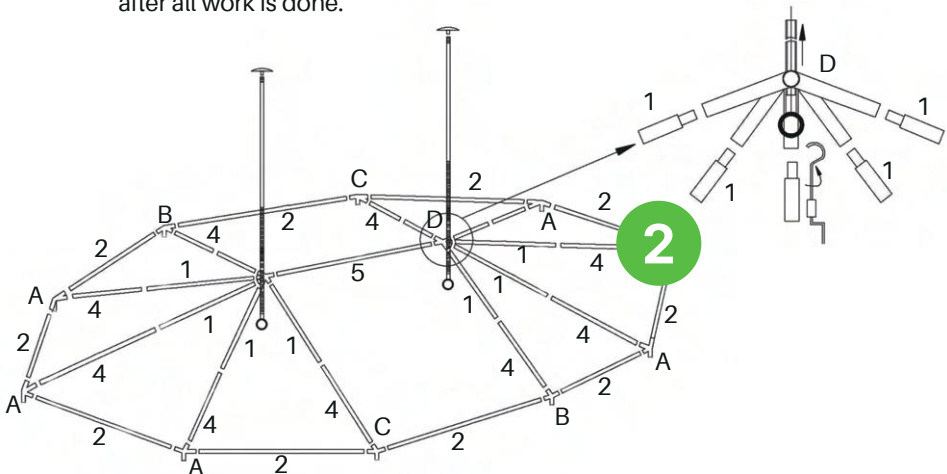

Step 3 You can finish assembling the Roof Cover (#J) and the supporting frame by:

- a) Tightening the Roof Cover (#J) to the assembled top frame with the Bungee Cords (#Q).
- b) Attaching one end of the 10 x poles (#3) to the connectors (#A, #B, and #C) on the top frame.
- c) Attaching the other end of the poles (#3) to the foot bases of 6 x #E and 4 x #F.
- d) Connecting the 10 x poles (#2A) to the foot bases (#E & #F) on the bottom.

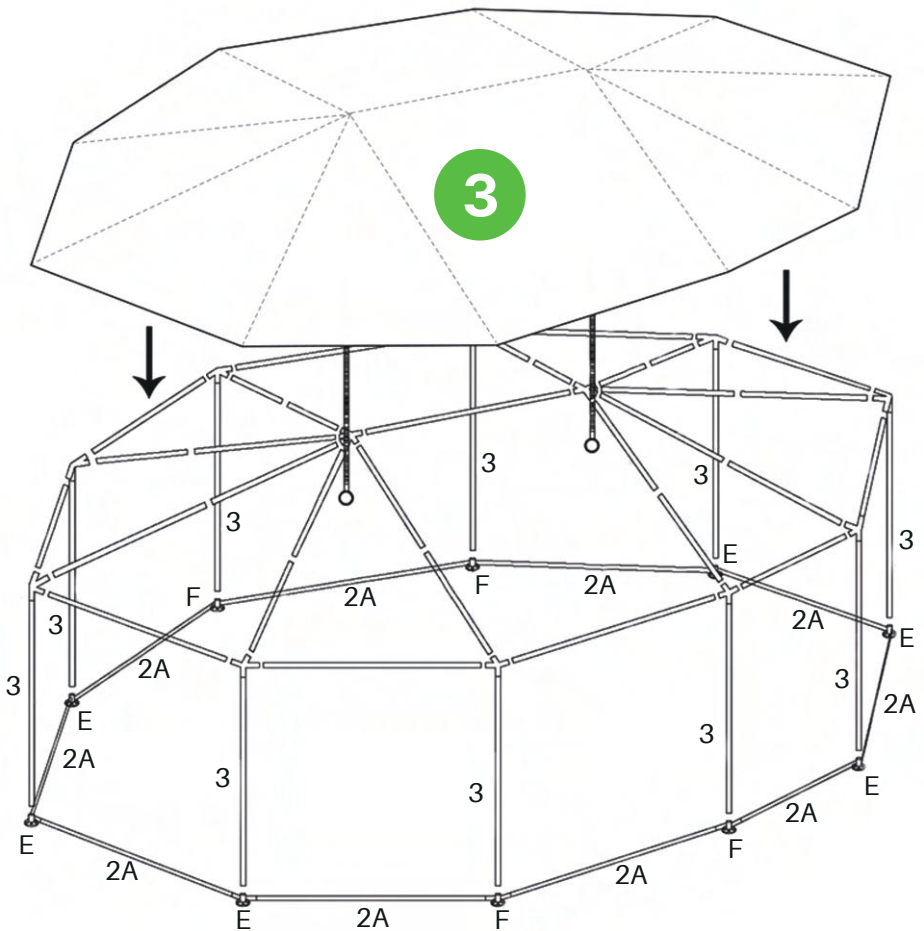

Step 4 Attach the 8 x Sidewalls with Window (#K) and the 2 x Zipper Doors (#K) as instructed below.

- a) Fix all the sides and doors to the top frame with the Bungee Cords (#Q) and by wrapping up the built-in velcros.
- b) Attaching one end of the 10 x poles (#3) to the connectors (#A, #B, and #C) on the top frame.
- c) Tighten/Loosen the 10 x Leg Covers (#M) by placing the hook into the different adjusting holes on the poles (#3).
- d) Fix the structure to the ground with the 10 x Guy Ropes (#M) and the 30 x L-Shaped Pegs (#E). To secure the tent better, it is recommended that you insert the L-Shaped Pegs **diagonally** into the ground. As shown, at a 45-degree to the ground is the best position.

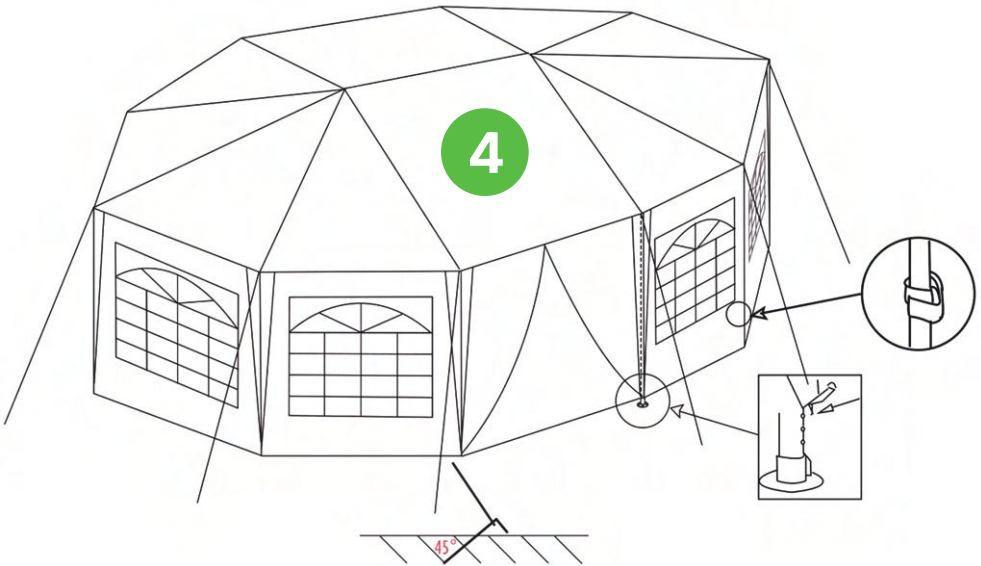

- Order number
- Required parts (name, quantity, and part number for each)
- Pictures (or video clips, if applicable)

Warning

- Restructuring the product without written permission from Quictent in advance would **VOID** the warranty.
- Damages due to improper use in severe weather conditions, including but not limited to high winds, heavy rain, sleet, snow, etc., will NOT be covered by the warranty.

Appendix

- **Shelter for Backyard, Party, Event**

Pop up Canopy



Quickest pop up canopies serve perfectly for your outdoor events, both personally and commercially. They always provide shades for outdoor activities such as parties, picnics, outings, etc, turning everywhere into a perfect place to relax. When it comes to selling at outdoor events, they are easy to handle in all aspects – unfolding (and folding), transporting, and storing. Rich in styles, sizes, and colors, you can always find one that goes well with your needs.

Party tent



Preparing for parties and events? We've got your back. Diverse in sizes from a small one in 10' x 8' to a regular one in 10' x 20' or 10' x 30' and to a large one in 20' x 40', you can always find a perfect solution matching your demands. What's more, they span a wide range of styles.

Metal Gazebo



Owning a Quicent metal gazebo is just like having another beautiful room in your backyard! The powder-coated steel frame is heavy-duty and can stand firmly outdoors for a long time. The mosquito netting adds privacy and protects you from bugs. The tan ones go with the surroundings well while the red ones are eye-catching.



Patio Umbrella

Quicent patio umbrellas turn anywhere in the open air into a perfect site to "take a breath". They are a must-have for small businesses such as an outdoor café! For homeowners, they make your backyard the best place to relax, especially when you're looking for an escape from the heavy work or energy-taking daily travails.

Shade Sail

Why Quicent provides so many choices for shade sails in colors and shapes? For aesthetics. Your patio would be pleasing to the eye if you mix shades in different colors and shapes, or overlap one a little while mounting others several feet higher or lower.



• Shelter for Vehicle

Carport



The Quictent carports share something in common: They are heavy-duty, easy-to-assemble, and of the most importance, supported by an industrial-leading after-sales service. You can choose from the ones with or without sidewalls depending on your needs.



Motorcycle Shelter

Recommended by so many riders, Quictent motorcycle shelters are proved to be the ultimate solution to protect your motorcycle from the elements. Buy one to see how the well-made cover and the heavy-duty structure realize the great protection.

Garage Shed

A Quictent outdoor storage shed is not only a budget-friendly solution to keep your belongings safe, but also helps organize your life – gone is the backyard/basement clutter.



Truck Tent



Light in weight and excellent in performance, Quicent truck bed tents are always a safer and more comfortable choice for road trips with a pickup truck. They can protect you from the elements when traveling and keep warm & keep you away from the crawling insects when sleeping. More importantly, whenever you want to stop to rest, the big awning would get you sheltered. Take one home and get your pickup ready for a trip!

RV Cover



The Quicent RV covers are a great investment for trailers of all kinds. Besides the great protection provided by the 6-layered tear-, water-, and UV-resistant cover, extra reinforced wind straps are the bonus coming with each order.

• Shelter for Plant

Greenhouse



As a necessity for all gardeners, Quicent greenhouses provide an ideal environment to ensure efficient growth and longer growing seasons. Available in mini, medium, and large walk-in ones.



Grow Tent

We highly recommend Quicent grow tents for anyone wanting to grow indoors. Passed the SGS certification, they'll help create an optimal growing environment. You're sure to be surprised by lots of built-in features like more reflective cover materials, the big observation window, convenient hooks, a waterproof tray floor, etc. Take one home to be the master of the temperatures, lights, humidity, and the like for your plants!

Garden Bed

A Quicent raised garden bed is highly recommended for gardening beginners since it makes you the controller of the size, location, and even soil conditions. An elevated one is the ultimate solution for gardeners with back pain or knee issues.



Quictent

SHELTERS FOR MOST PEOPLE



QT-USHF-ARABIC-202201