



User Manual

for Quictent Pole Tent



Please read, understand, and practice the guidelines in this user manual before use, and keep it for future reference.

20' x 20' (Fireproof Certificate Available)

20' x 40'

The **Parts List** varies by the model. Please check the correct list according to the product you have.

sales@quictents.com

maxlead.us@gmail.com

Table of Contents

● About Quictent	2
● Safety Instructions	2
● 20' x 20' Pole Tent (Model #GM1411W-FP)	4
● 20' x 40' Pole Tent (Model #GM1420W)	10
● Maintenance	16
● Warranty	16
● Appendix	17

Important

We'd love to hear from our customers. If you have any questions about the manual, have any comments or suggestions about our products and our service, or would like us to help in any way, please feel free to contact the support team. We will reply in 12 hours (business days).

- Check **the Spam** and your **email Settings** if you do not receive a reply in time as it is probably blocked because our support team will always get back to you no later than the timeframe.
- Add the following email address to your **CONTACT LIST** in case of any blocking.
- **Email: sales@quictents.com, maxlead.us@gmail.com.**

This user manual applies to Quictent pole tents in 20' x 20' and 20' x 40". It will help you to get to know your Quictent pole tent. Please read the guidelines in this manual and keep the manual for future reference.

We may update the manual without notice in advance. You can always search "**Quictent Instructions**" online for the latest version.

About Quicent

Founded in the early 21st century, Quicent has grown into a popular brand with reliable products and excellent customer service during the past decades. We started with pop up canopies, and then expanded to other more categories of shelters and the like including pole tents, carports, green-houses, garden beds, grow tents, shade sails, patio umbrellas, and RV covers. Driven by the vision to create unique spaces to meet every specific need and a part of America's landscape, we at Quicent would spare no effort to keep innovating.

Our Vision

To create unique spaces to meet every specific need, and become a part of America's landscape.

Our Mission

To keep innovating and provide a wide range of reliable shelters and shades at consumer-grade prices with customer-first service.

Our Service

The customer-centric service is what we at Quicent take great pride in. In addition to the hassle-free warranty covering all Quicent products, an industrial-leading support team is standing behind at all times. Whenever you need help or have any suggestions and comments about Quicent, do not hesitate to reach us via sales@quicents.com or maxlead.us@gmail.com. You're sure to get a to-the-point reply in 12 hours.

Safety Instructions

You should read, understand, and practice safety instructions in this chapter. For any damages due to not obeying guidelines as instructed, the owner (user) should take full responsibility.

Call Before You Dig

- You're required by law to contact your local "Call Before You Dig" in advance for any digging projects. For more detailed information, please search "811 In Your State".
- Please wait patiently and do not start your project before utility companies send out locators who will come to your dig site to mark the approximate location of buried utilities with paint or flags.
- You should also dig carefully around the marks made by locators, not on them. For any damages or loss due to improper operations, the owner (worker) should take accountability.

Site Selection

Look carefully at the factors below when selecting a site.

- Location - Elevated, level, and clear of debris.
- Soil Conditions - Adequate for anchoring.
- Site Access - Services and delivery can easily be achieved.
- Space - Free of any electrical lines or tree branches overhead, no buried lines underneath, and no hindering obstructions nearby and around.
- Emergency Exits - Easily accessible exit routes in case of emergency.

Safety Checklist

- Monitor weather conditions and wait for a proper installation time.
- Steel toe boots, hard hats, and gloves are recommended.
- Clean the poles before installation.
- Repair or replace any required tools in poor condition.
- Inspect the desired site, for example, look for overhead and underground obstructions, and make sure no kids around, before installation.
- Inspect all poles and ropes to make sure there are no bends or breaks before assembly.

Warning & Reminders

- Do NOT leave a tent unattended overnight.
- Do not use and leave the structure outside in inclement weather. The owner (or user) should take down the structure for any potential inclement weather such as high winds, heavy rain, sleet, snow, and the like, or he (she) should take the loss.
- Do NOT throw away the original packaging cartons in case of a return or an exchange.
- You can ALWAYS contact the support team for replacement parts whenever in need.

20' x 20' (Model #GM1411W-FP)

Email us for the fireproof certificate of NFA 701&CPAI-84 (PDF file).

Parts List

You'll receive three (3) boxes for each tent. Please check to identify the packages by referring to **Table B** below. Pay particular attention to making sure all parts are numbered and graphically indexed as shown on the **Parts List (Table A)**, so does the quantity for each part. If you need any help, please contact us promptly (sales@quicktents.com or maxlead.us@gmail.com) with the **ORDER NUMBER, REQUIRED PARTS (NAME, QUANTITY, and PART NUMBER), PICTURES (OR VIDEO CLIPS, IF APPLICABLE)**, we'll get back and help out soon.

Table A. Parts List









Part Number	Diagram	Description	Quantity (PCS)
#1		Side Pole	8
#2		Upper Center Pole	1
#3		Lower Center Pole	1
#A		Anchor	12
#B		Tie-Down Rope with Wooden Block	12
#C		Rope	4
#D		L-Shaped Peg	26
#E		Window Sidewall	2
#F		Window Sidewall with Zipper	2
#G		Roof Cover	1

Table B. Package Contents for Shipping Cartons

Carton Number	Parts Included
Box #1	1 x Part #G (Roof Cover)
Box #2	12 x Part #A (Anchor) 12 x Part #B (Tie-Down Rope with Wooden Block) 2 x Part #C (Rope) 26 x Part#D (L-Shaped Peg) 2 x Part #E (Window Sidewall) 2 x Part #F (Window Sidewall with Zipper)
Box #3	8 x Part #1 (Side Pole) 1 x Part #2 (Upper Center Pole) 1 x Part #3 (Lower Center Pole)

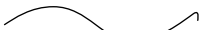
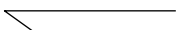
Assembly

Before the assembly, please make sure that you have all the parts in the **Parts Lists**.

Required Tools

They are not provided. Please prepare them by yourself before the assembly.

- The hammer is a must when staking down the anchors.
- Placing the Roof Cover (#G) directly on the ground is never a good idea. We highly recommend you protect your tent fabric from dirt or damage with a drop cloth.

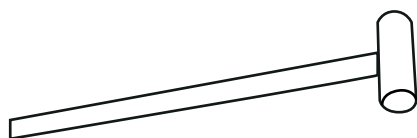

1 x hammer (a must)



1 x drop cloth (highly recommended)

Step 1 Unfold the Roof Cover (#G).

- Spread a drop cloth on where you're allowed to dig to set up the tent.
- Lay the Roof Cover (#G) over the drop cloth.
- Pull the perimeter of the cover as flat as possible. Please be careful and do not damage the fabric.

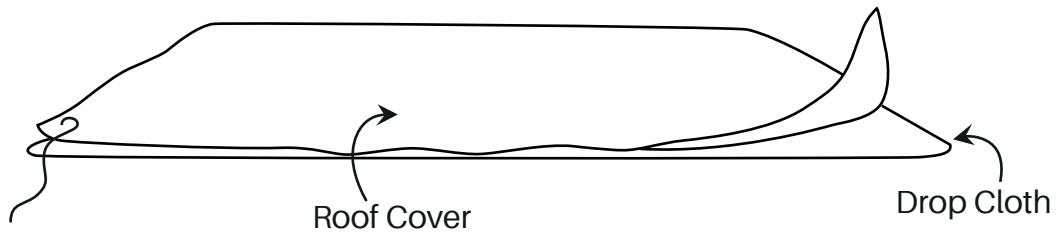

Step 2 Layout the 4 x Side Poles (#1) and the 12 x Anchors (#A) around the roof cover.

- a) Layout the 4 x Side Poles (#1) at the 4 corners of the roof cover.
- b) Place each anchor approximately 6' away from the perimeter locations. Please note that the 2 anchors at each corner location should be 90 degrees apart.

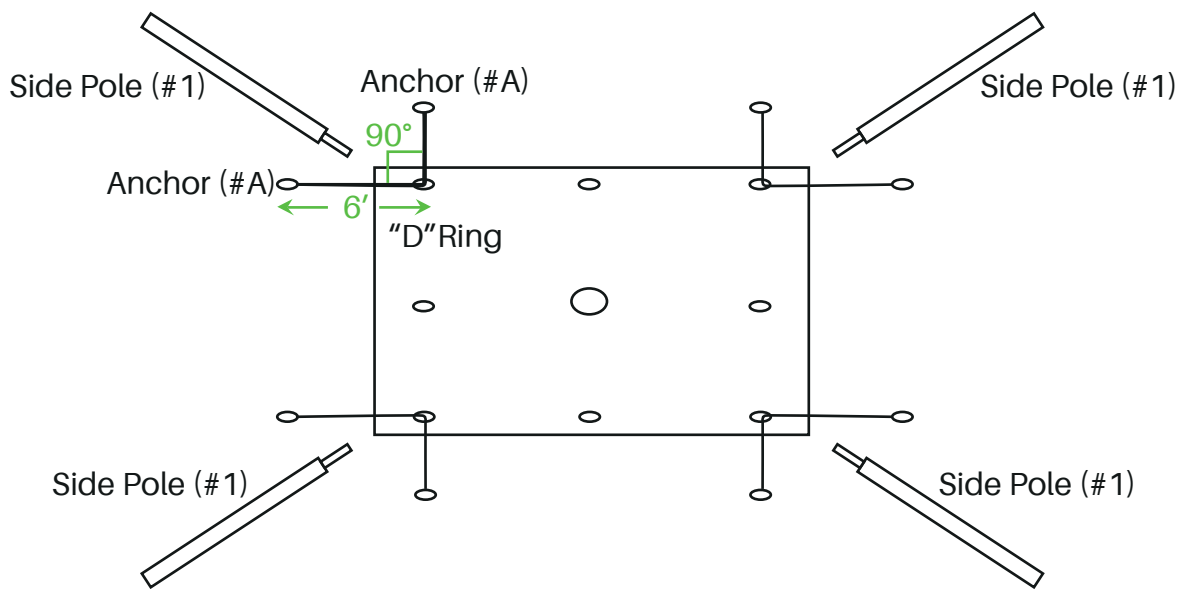

Step 3 Hammer the Anchors (#A) diagonally into the ground, leaving 6" showing over the ground.

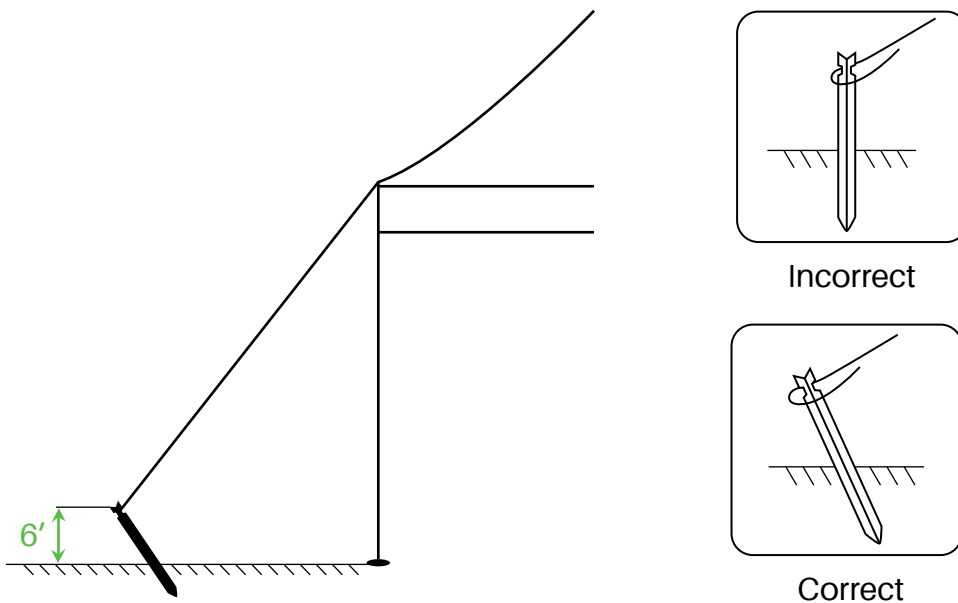

Step 4 Erect the 4 x Side Poles (#1).

- a) Insert the pole pin through the metal "D" ring (at the four corners of the roof cover) and the brass grommet of each side pole.
- b) Thread 2 x Tie-Down Ropes (#B) through each pole pin.
- c) Tie the other end of the Tie-Down Ropes to the anchors.
- d) Raise the 4 x Side Poles (#1) to their upright position.
- e) Adjust the Tie-Down Ropes (#B) to make sure all poles are well-secured.

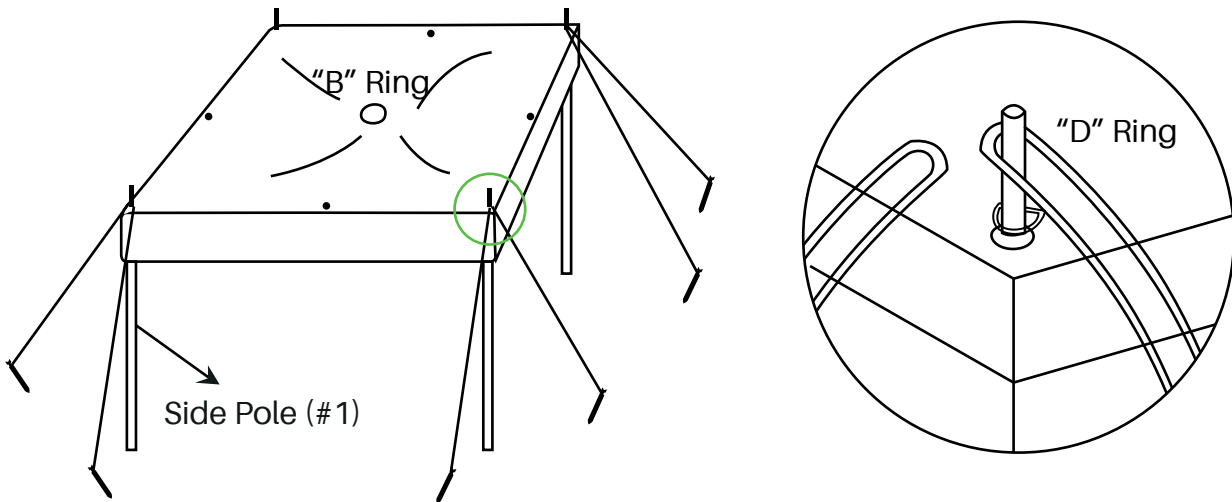

Step 5 Assemble the center pole.

- a) Connect the Lower Center Pole (#3) with the Upper Center Pole (#2).
- b) Insert the tip end of the Upper Center Pole (#2) through the "B" ring (near the pre-drilled hole at the peak of the roof cover) and the brass grommet. Please be sure not to puncture the roof cover.
- c) Lift the connected center pole into a vertical position.
- d) Secure the top of the Upper Center Pole (#2) with buckles and bolts.

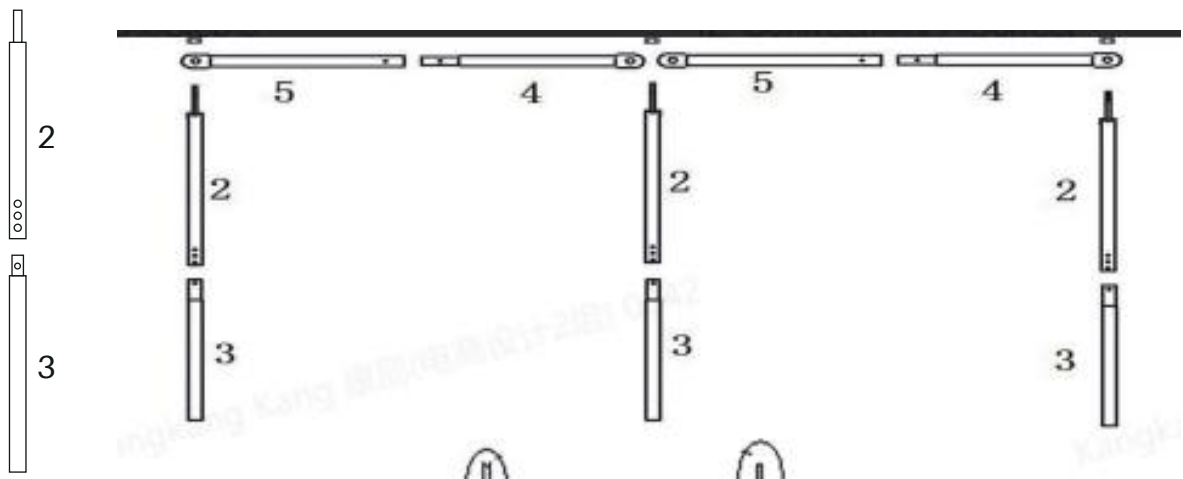

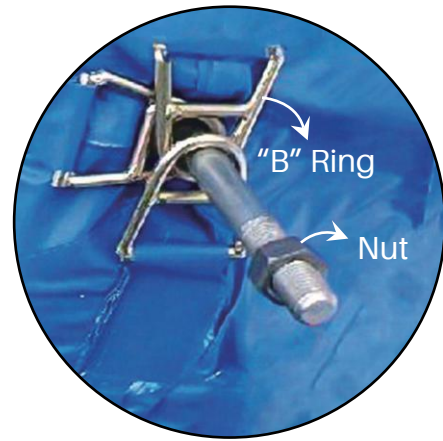
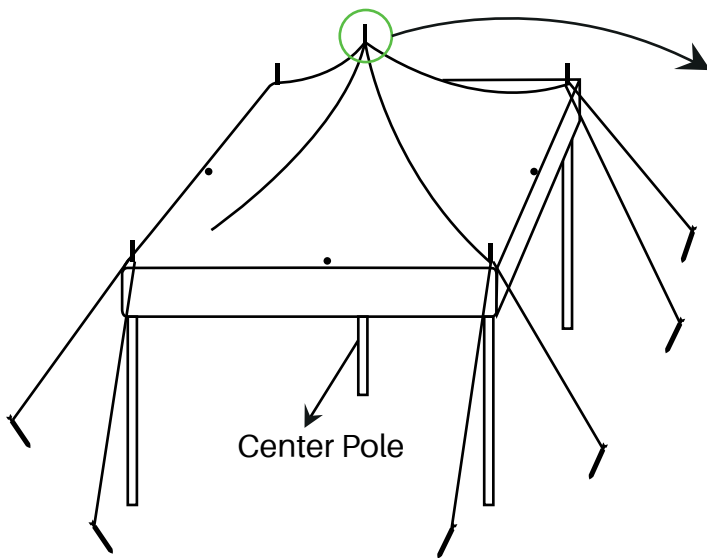

View of the Tent Top from Inside

Step 6 Assemble the other 4 x Side Poles (#1).

- a) Insert the pole pin through the metal "D" ring (at the four corners of the roof cover) and the brass grommet for each side pole.
- b) Thread 2 x Tie-Down Ropes (#B) through each pole pin.
- c) Tie the other end of the Tie-Down Ropes (#B) to the anchors.
- d) Raise the 2 x Side Poles (#1) and adjust them to their upright position.

IMPORTANT

In case of any collapse due to uneven forces, please check to make sure all poles are stable and all tie-down ropes are in full tension before moving to the next step.

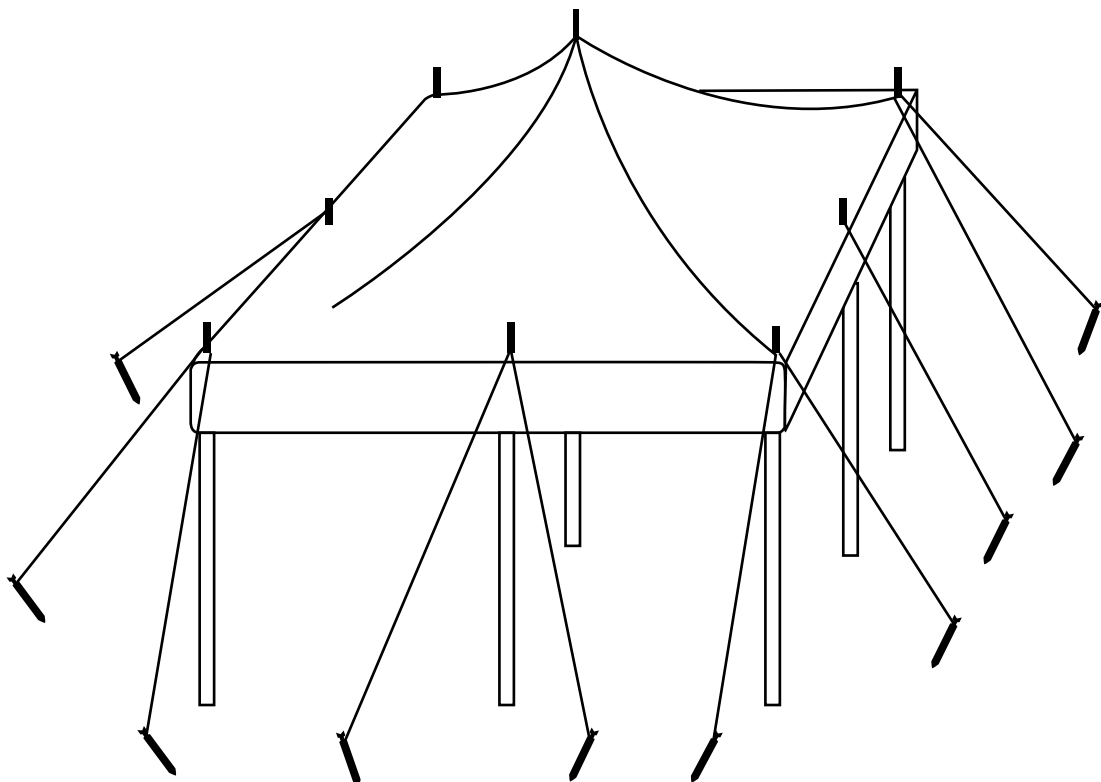

Step 7 Attach the Sidewalls (#E & #F).

- a) Attach the sidewalls to the inner eaves of the roof cover by hooking the metal clips with the ropes. (The metal clips are on the top of the sidewalls, the ropes have been built in the edge of the roof cover.)
- b) Fix the sidewalls with the side poles by using the built-in Velcro straps.
- c) Tie the sidewalls with the side poles at the 4 corners by zigzagging the Ropes (#C).
- d) Fix the sidewalls to the ground by inserting the L-Shaped Pegs (#D) into the bottom edge (There are pre-drilled holes).

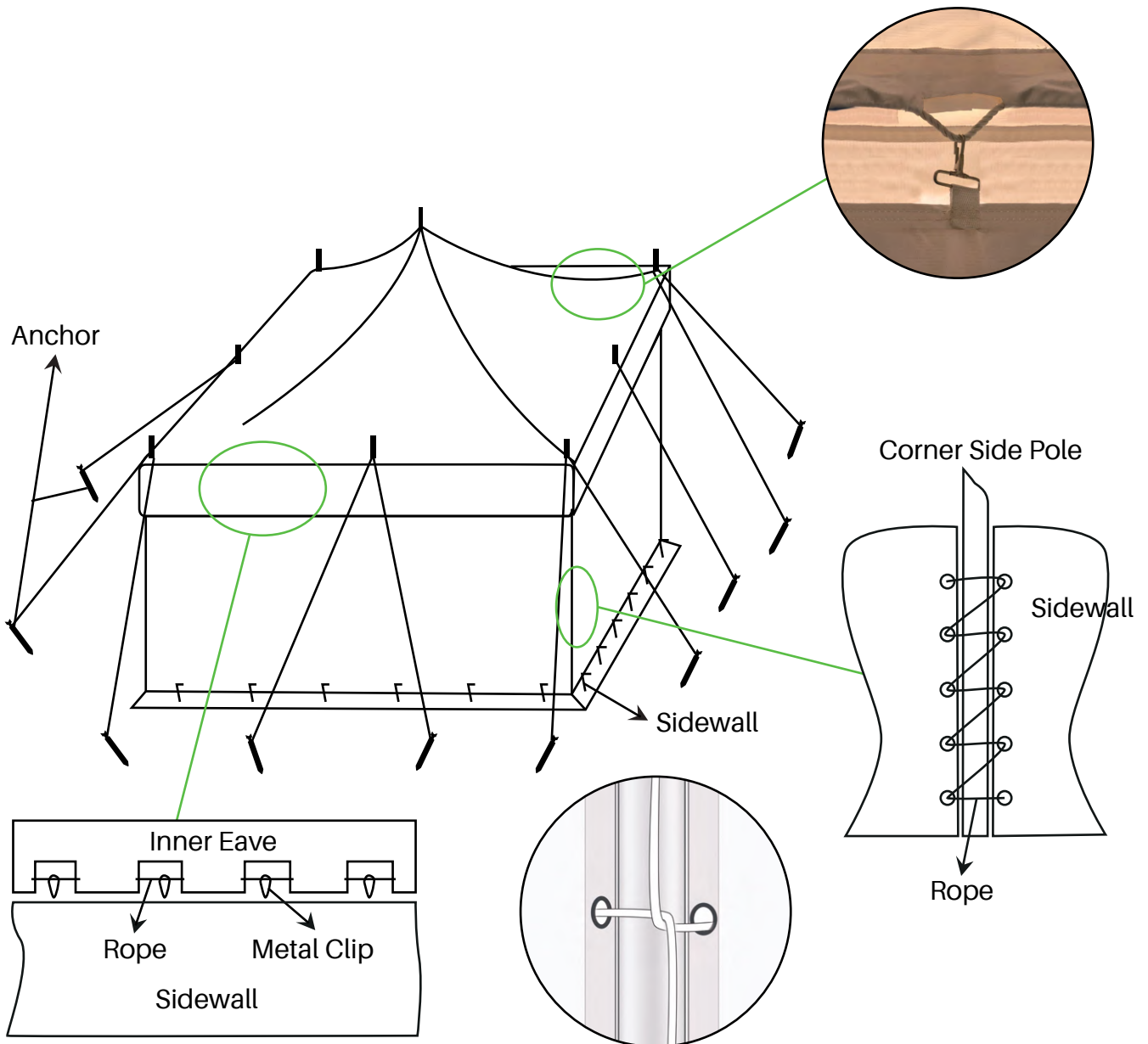

20' x 40' (Model #GM1420W)

Parts List

You'll receive six (6) boxes for each tent. Please check to identify the packages by referring to **Table B** below. Pay particular attention to making sure all parts are numbered and graphically indexed as shown on the **Parts List (Table A)**, so does the quantity for each part. If you need any help, please contact us promptly (sales@quicktents.com or maxlead.us@gmail.com) with the **ORDER NUMBER, REQUIRED PARTS (NAME, QUANTITY, and PART NUMBER), PICTURES (OR VIDEO CLIPS, IF APPLICABLE)**, we'll get back and help out soon.

Table A. Parts List







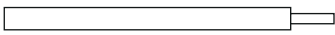

Part Number	Diagram	Description	Quantity (PCS)
#1		Side Pole	12
#2		Upper Center Pole	3
#3		Lower Center Pole	3
#4		Top Pole (Right)	2
#5		Top Pole (Left)	2
#A		Anchor	22
#B		Tie-Down Rope with Wooden Block	22
#C		Rope	4
#D		L-Shaped Peg	32
#E		Roof Cover	1
#F		Window Sidewall	2
#G		Window Sidewall with Zipper	2

Table B. Package Contents for Shipping Cartons

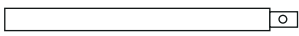
Carton Number	Parts Included
Box #1	11 x Part #A (Anchor) 1 x Part #E (Roof Cover)
Box #2	6 x Part #A (Anchor) 11 x Part #B (Tie-Down Rope with Wooden Block) 2 x Part #C (Rope) 1 x Part #F (Window Sidewall) 1 x Part #G (Window Sidewall with Zipper)
Box #3	5 x Part #A (Anchor) 11 x Part #B (Tie-Down Rope with Wooden Block) 2 x Part #C (Rope) 32 x Part #D (L-Shaped Peg) 1 x Part #F (Window Sidewall) 1 x Part #G (Window Sidewall with Zipper)
Box #4	4 x Part #1 (Side Pole) 3 x Part #2 (Upper Center Pole)
Box #5	4 x Part #1 (Side Pole) 3 x Part #3 (Lower Center Pole)
Box #6	4 x Part #1 (Side Pole) 2 x Part #4 (Top Pole) 2 x Part #5 (Top Pole)

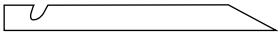
Assembly

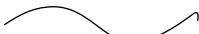
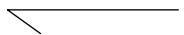
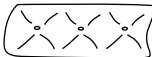
Before the assembly, please make sure that you have all the parts in the **Parts Lists**.

Required Tools

They are not provided. Please prepare them by yourself before the assembly.

- The hammer is a must when staking down the anchors.
- Placing the Roof Cover (#G) directly on the ground is never a good idea. We highly recommend you protect your tent from damages with a drop cloth.

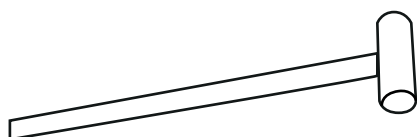

1 x hammer (a must)



1 x drop cloth (highly recommended)

Step 1 Unfold the Roof Cover (#E).

- a) Spread a drop cloth on where you're allowed to dig to set up the tent.
- b) Lay the Roof Cover (#E) over the drop cloth.
- c) Pull the perimeter of the cover as flat as possible. Please be careful and do not damage the fabric.

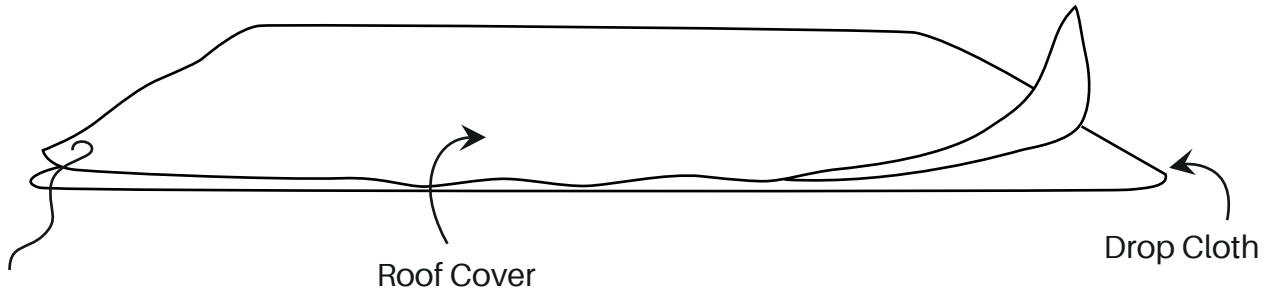

Step 2 Layout the 4 x Side Poles (#1) and the 22 x Anchors (#A) around the roof cover.

- a) Layout the 4 x Side Poles (#1) at the 4 corners of the roof cover.
- b) Place each anchor approximately 6' from the perimeter locations. Please note that the 2 anchors at each corner location should be 90 degrees apart.

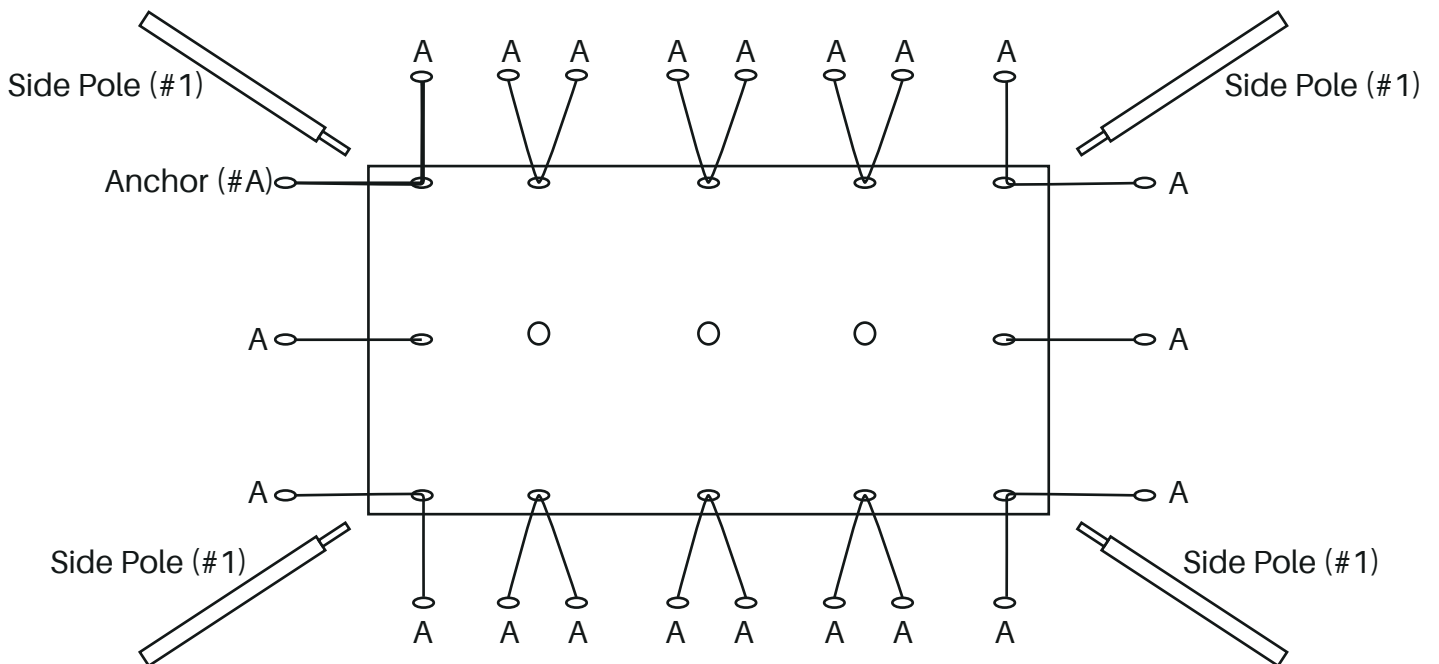

Step 3 Hammer the Anchors (#A) diagonally into the ground, leaving 6" showing over the ground.

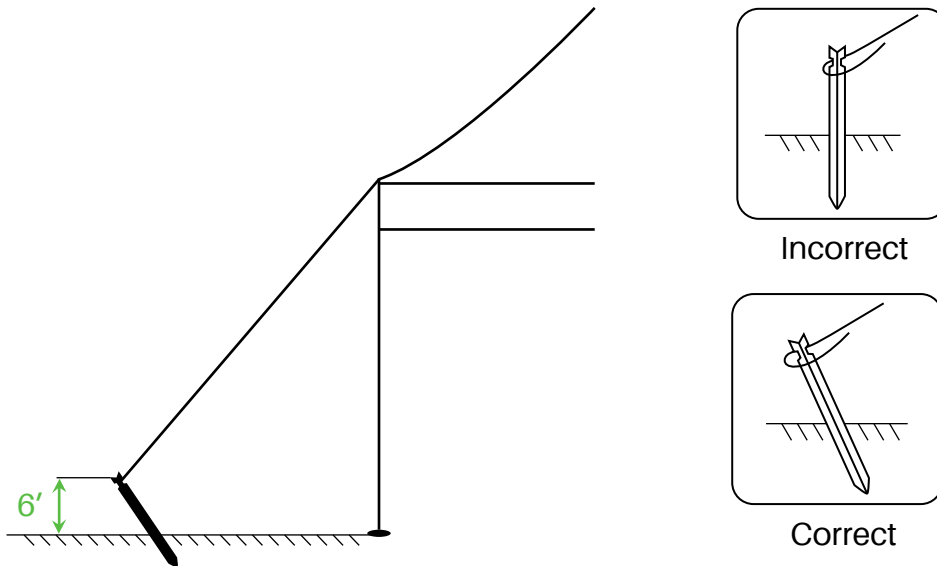

Step 4 Erect the 4 x Side Poles (#1).

- Insert the pole pin through the metal "D" ring (at the four corners of the roof cover) and the brass grommet of each side pole.
- Thread 2 x Tie-Down Ropes (#B) through each pole pin.
- Tie the other end of the Tie-Down Ropes to the anchors.
- Raise the 4 x Side Poles (#1) to their upright position.
- Adjust the Tie-Down Ropes (#B) to make sure all poles are well-secured.

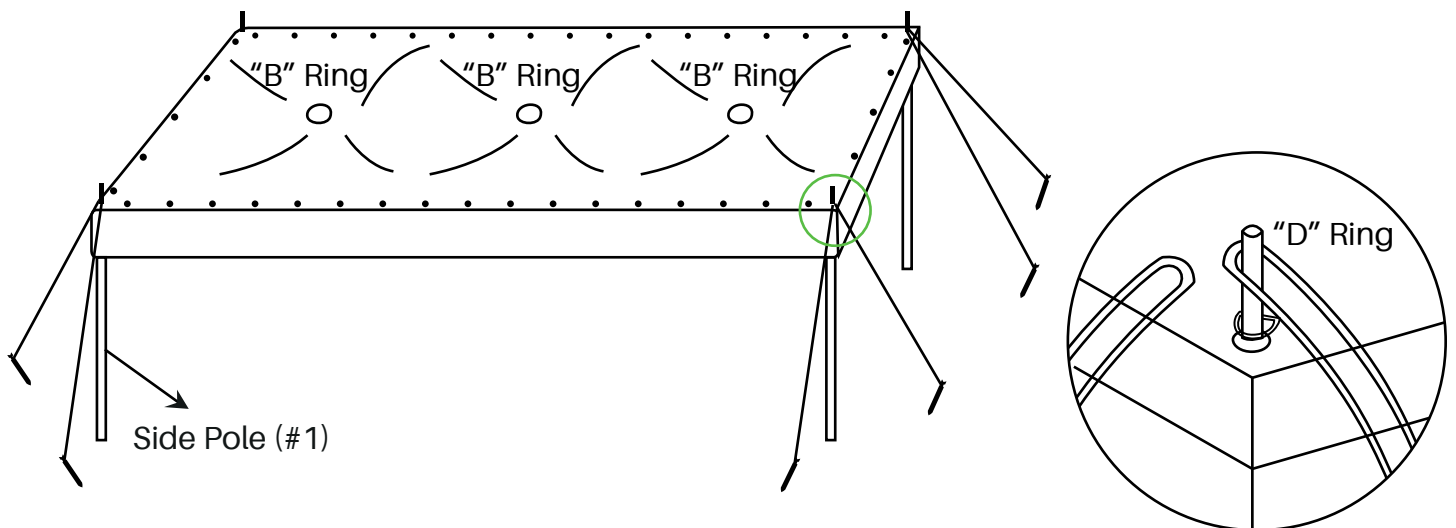

Step 5 Assemble the center pole.

- Connect the Top Poles (#4) with the Top Poles (#5), and attach them to the top of the tent.
- Connect the Lower Center Pole (#3) with the Upper Center Pole (#2).

- c) Attach the tip end of the Upper Center Poles (#2) to the end of the Top Poles (#5) by inserting it through the "B" ring (near the pre-drilled hole on the peak of the roof cover) and the brass grommet. Please be sure not to puncture the roof cover.
- d) Secure the top of the Upper Center Pole (#2) with buckles and bolts.

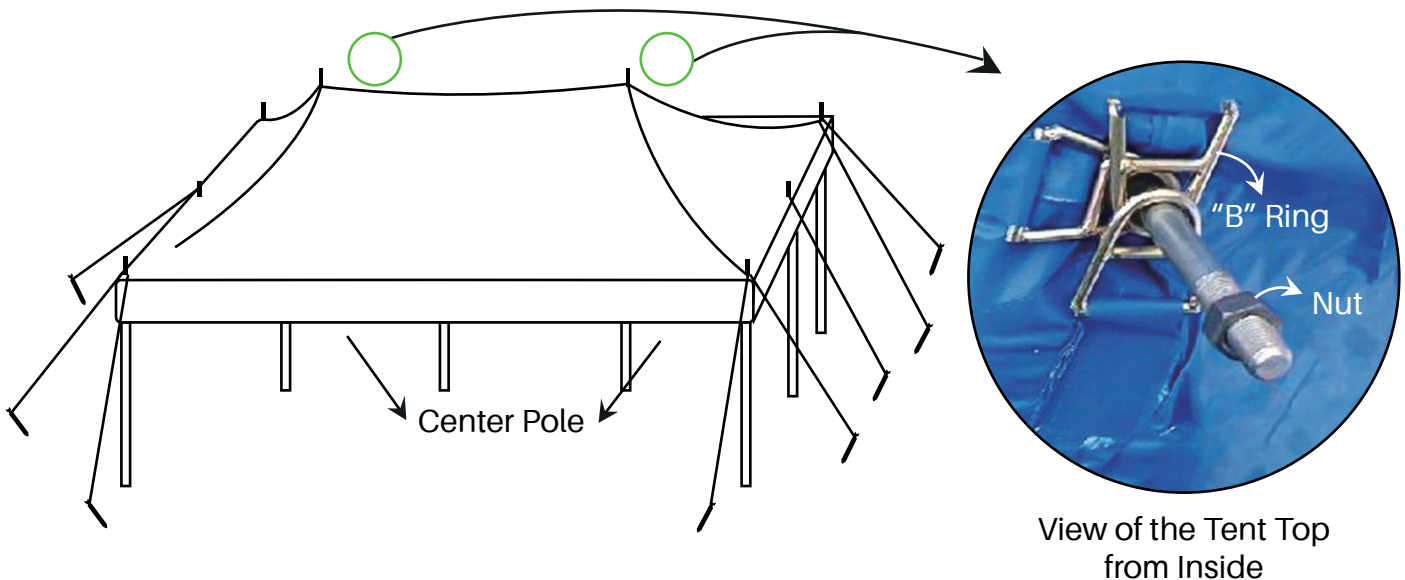
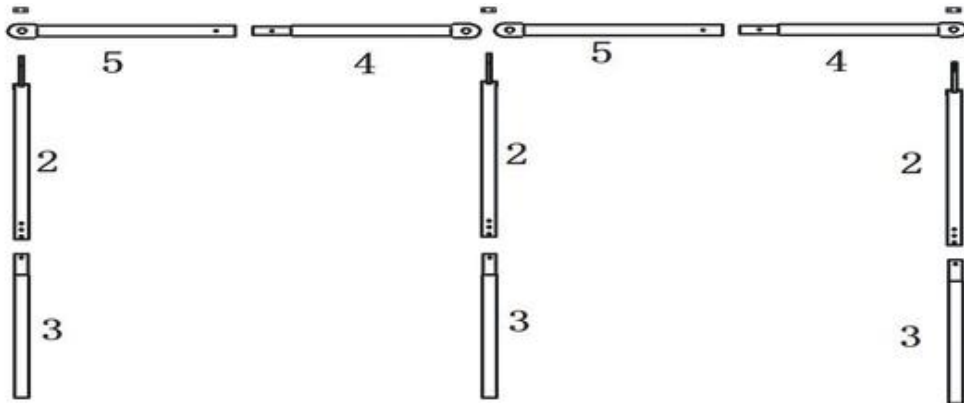

Step 6 Assemble the other 8 x Side Poles (#1).

- a) Insert the pole pin through the metal "D" ring (at the four corners on the roof cover) and the brass grommet of each side pole.
- b) Thread 2 x Tie-Down Ropes (#B) through each pole pin.
- c) Tie the other end of the Tie-Down Ropes (#B) to the anchors.
- d) Raise the 8 x Side Poles (#1) and adjust them to their upright position.

IMPORTANT

In case of any collapse due to uneven forces, please check to make sure all poles are stable and all tie-down ropes are in full tension before moving to the next step.

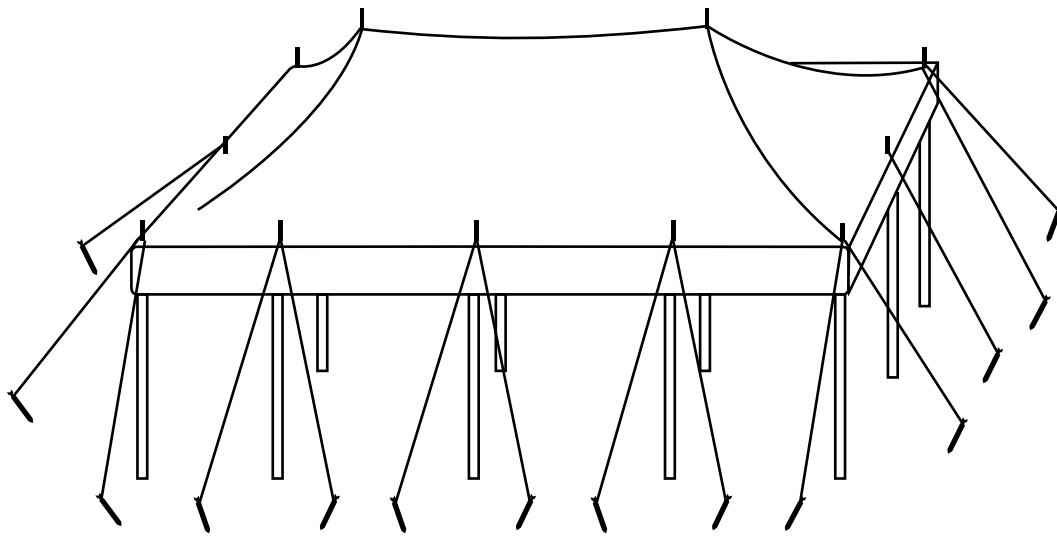

Step 7 Attach the Sidewalls (#F & #G).

- a) Attach the sidewalls to the inner eaves of the roof cover by hooking the metal clips with the ropes. (The metal clips are on the top of the sidewalls, the ropes have been built in the edge of the roof cover.)
- b) Fix the sidewalls with the side poles by using the built-in Velcro straps.
- c) Tie the sidewalls with the side poles at the 4 corners by zigzagging the Ropes (#C).
- d) Fix the sidewalls to the ground by inserting the L-Shaped Pegs (#D) into the bottom edge (There are pre-drilled holes).

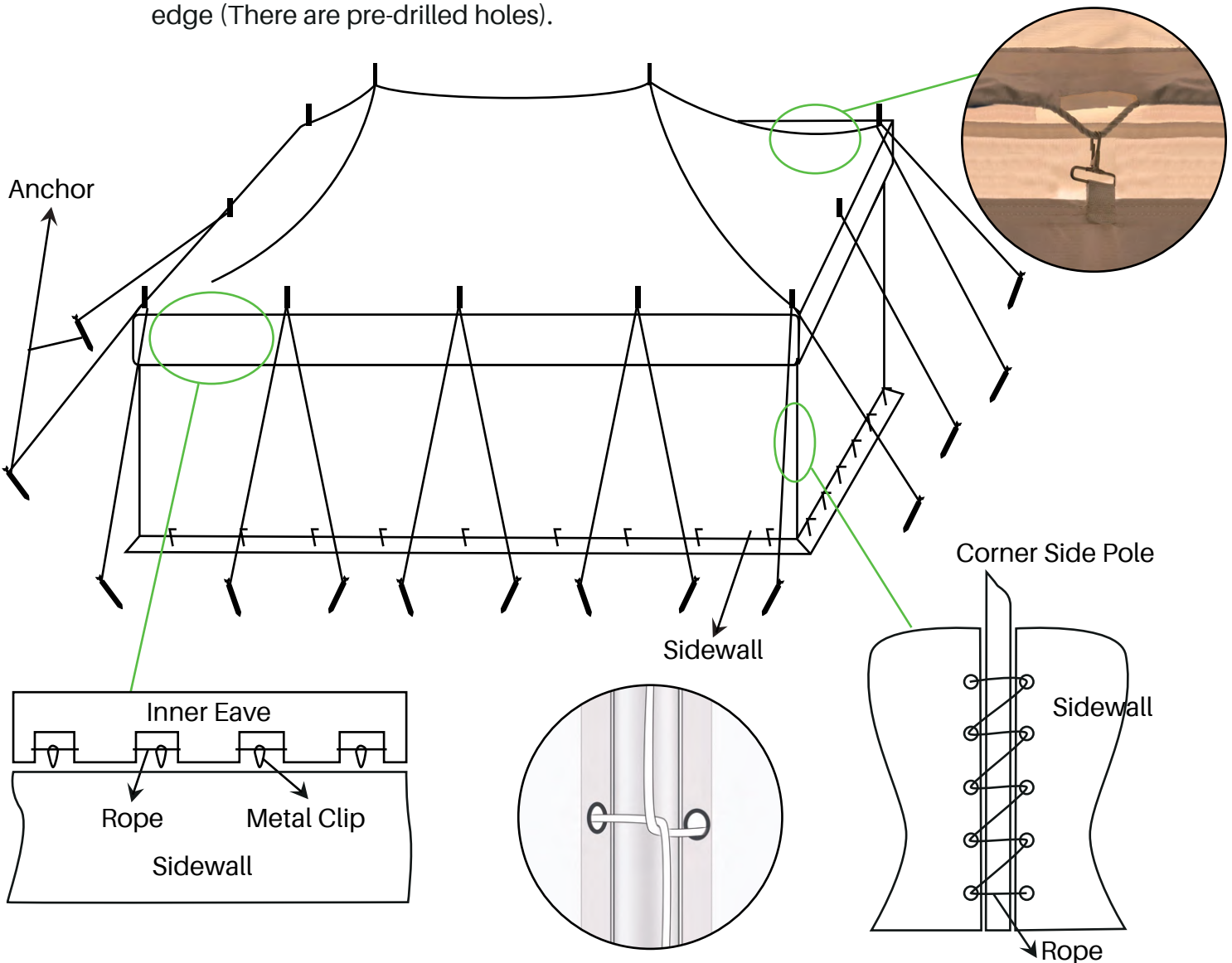

Appendix

• Shelter for Backyard, Party, Event Pop up Canopy



Quicent pop up canopies serve perfectly for your outdoor events, both personally and commercially. They always provide shades for outdoor activities such as parties, picnics, outings, etc, turning everywhere into a perfect place to relax. When it comes to selling at outdoor events, they are easy to handle in all aspects - unfolding (and folding), transporting, and storing. Rich in styles, sizes, and colors, you can always find one that goes well with your needs.

Party Tent



Preparing for parties and events? We've got your back. Diverse in sizes from a small one in 10' x 8' to a regular one in 10' x 20' or 10' x 30' and to a large one in 20' x 40', you can always find a perfect solution matching your demands. What's more, they span a wide range of styles.

Metal Gazebo



Owning a Quicent metal gazebo is just like having another beautiful room in your backyard! The powder-coated steel frame is heavy-duty and can stand firmly outdoors for a long time. The mosquito netting adds privacy and protects you from bugs. The tan ones go with the surroundings well while the red ones are eye-catching.



Patio Umbrella

Quicent patio umbrellas turn anywhere in the open air into a perfect site to "take a breath". They are a must-have for small businesses such as an outdoor café! For homeowners, they make your backyard the best place to relax, especially when you're looking for an escape from the heavy work or energy-taking daily travails.

Shade Sail

Why Quicent provides so many choices for shade sails in colors and shapes? For aesthetics. Your patio would be pleasing to the eye if you mix shades in different colors and shapes, or overlap one a little while mounting others several feet higher or lower.



• Shelter for Vehicle

Carport



The Quicent carports share something in common: They are heavy-duty, easy-to-assemble, and of the most importance, supported by an industrial-leading after-sales service. You can choose from the ones with or without sidewalls depending on your needs.



Motorcycle Shelter

Recommended by so many riders, Quicent motorcycle shelters are proved to be the ultimate solution to protect your motorcycle from the elements. Buy one to see how the well-made cover and the heavy-duty structure realize the great protection.

Garage Shed

A Quicent outdoor storage shed is not only a budget-friendly solution to keep your belongings safe, but also helps organize your life – gone is the backyard/basement clutter.



Truck Tent



Light in weight and excellent in performance, QuicTent truck bed tents are always a safer and more comfortable choice for road trips with a pickup truck. They can protect you from the elements when traveling and keep warm & keep you away from the crawling insects when sleeping. More importantly, whenever you want to stop to rest, the big awning would get you sheltered. Take one home and get your pickup ready for a trip!

RV Cover



The QuicTent RV covers are a great investment for trailers of all kinds. Besides the great protection provided by the 6-layered tear-, water-, and UV-resistant cover, extra reinforced wind straps are the bonus coming with each order.

• Shelter for Plant Greenhouse



As a necessity for all gardeners, Quicent greenhouses provide an ideal environment to ensure efficient growth and longer growing seasons. Available in mini, medium, and large walk-in ones.

Grow Tent



We highly recommend Quicent grow tents for anyone wanting to grow indoors. Passed the SGS certification, they'll help create an optimal growing environment. You're sure to be surprised by lots of built-in features like more reflective cover materials, the big observation window, convenient hooks, a waterproof tray floor, etc. Take one home to be the master of the temperatures, lights, humidity, and the like for your plants!

Garden Bed



A Quicent raised garden bed is highly recommended for gardening beginners since it makes you the controller of the size, location, and even soil conditions. An elevated one is the ultimate solution for gardeners with back pain or knee issues.

Quictent

SHELTERS FOR MOST PEOPLE



QT-TL-PTENT-202101