



MINI-SPLIT HEATING AND COOLING SYSTEMS
FOR RESIDENTIAL AND LIGHT COMMERCIAL APPLICATIONS

FUJITSU GENERAL AMERICA, INC.



QUIETLY REVOLUTIONIZING ENERGY-EFFICIENT HOME



COMFORT.

TABLE OF CONTENTS

FEATURES

Mini-Splits Defined.....	4
Individual Zoning	6
Comfort Solution	8
Energy Efficient	9
Comfort & Convenience	10
Applications	11
FGLair® App.....	12
WiFi Selection Guide.....	13
XLTH Story	14
Feature Explanation.....	15
System Feature Summary Table	16

MODEL LINEUP

Indoor and Outdoor Model Table.....	18
-------------------------------------	----

SINGLE-ZONE MINI-SPLITS

Wall Mount.....	20
Floor Mount.....	32
Compact Cassette	34
Slim Duct.....	36
Medium Static Ducted	38
Multi-Position Air Handler UNit.....	40
Universal Floor/Ceiling.....	42
Ceiling Suspended	42
Large Cassette	44

MULTI-ZONE MINI-SPLITS

Overview	46
Wall Mount.....	50
Slim Duct.....	52
Compact Cassette	54
Floor Mount.....	56
Multi-Zone (2-5 Zones)	58
XLTH Multi-Zone (2-4 Zones).....	60
Whole Home Solution.....	62
Allowable Combinations.....	64

ACCESSORIES

Compatibility Chart.....	66
Airzone	68
Descriptions	69

MISCELLANEOUS

Line Set Length Chart - Single-Zone	72
Line Set Length Chart - Multi-Zone.....	73
Model Nomenclature.....	74
Warranty, Misc. Info	75



FUJITSU MINI-SPLITS: YEAR-ROUND, WHOLE-HOME OR BUSINESS ENERGY EFFICIENT HEATING AND COOLING

WHAT IS A MINI-SPLIT?

Halcyon systems eliminate the need for a traditional central system and bulky ductwork by using small tubing that pumps refrigerant directly to discreet wall mounted or concealed units inside. Even more remarkable, this same system works in reverse during the cold season, absorbing heat energy from the outside air and moving it indoors to heat your home. The result? Efficient year-round cooling and heating, zoning flexibility, and optimum comfort in any climate.

Available in numerous mix-and-match capacities and configurations, there's a Halcyon mini-split system for even the most difficult to heat and cool areas.

HOW DOES A MINI-SPLIT WORK?

A heat pump uses electricity to pump refrigerant and transfer heat energy from one space to another. In the summer, heat energy from inside is absorbed and released outdoors. In the winter, heat energy is absorbed from the outside air and released inside.



WALL MOUNT UNIT



SLIM DUCT UNIT



HEAT PUMPS PROVIDE HEAT WHEN IT IS COLD

Fujitsu heat pumps absorb heat from the outdoors, and release it within your home, even on the coldest of days. We use efficient compressors to pump refrigerant via small copper tubing from outdoors to indoors. Inverter efficiency allows us to transfer heat at a ratio of 3 to 4 times higher compared to electric baseboard heat.

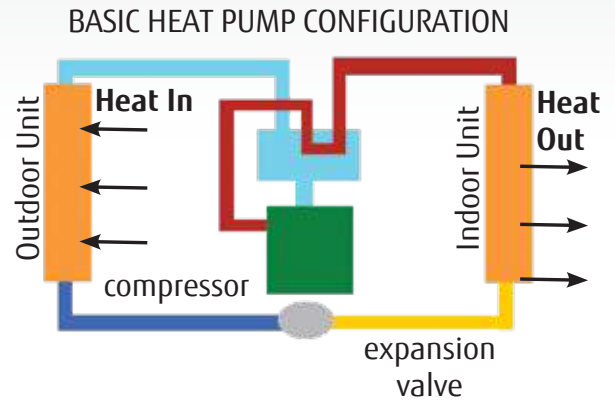

AIR CONDITIONERS PROVIDE COOLING WHEN IT'S WARM

Come spring and summer, simply reverse the process and put the same system into "cooling mode" and transfer heat from indoors to the outside. For many climates, the advanced technology that goes into these units creates a far more cost effective alternative to either gas or oil-fired units for heat, or a central ducted system for air conditioning. Fujitsu's full mini-split line is comprised of heat pumps, which provide both heating and cooling.

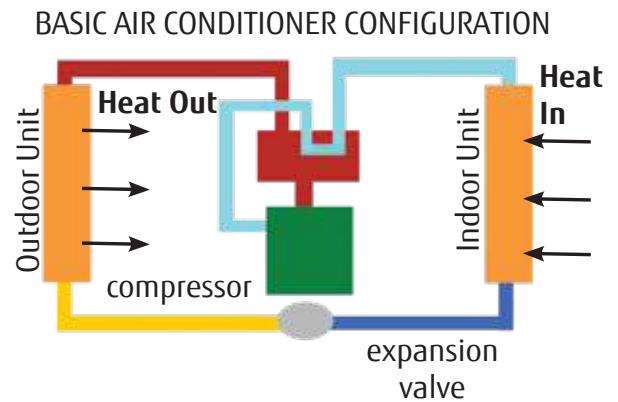

ELECTRIC HEATERS VERSUS HEAT PUMPS

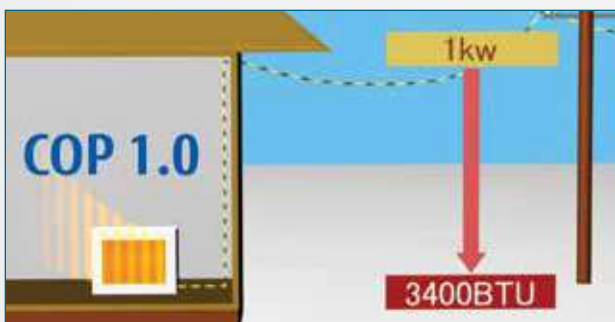

An electric heater converts electricity directly to heat. For every kW of electricity used, 3,400 BTUH of heat are produced. Ironically, electric heaters are 100% efficient, however the ratio of power input to heat output* is only 1.0.

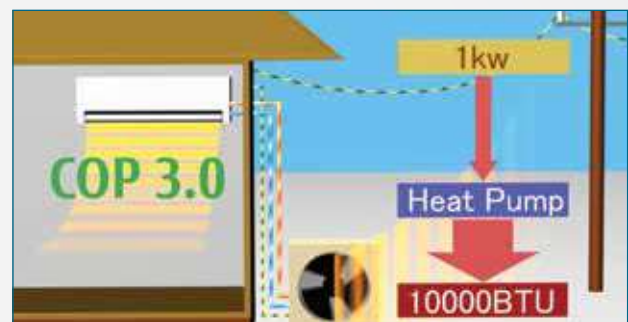

Heat pumps are more efficient than many other forms of heating because heat pumps do not actually create heat - they just move it from one place to another. For example, a heat pump with a COP of 3.0 will produce three times the heat output per power input, compared to an electric resistance heater with a COP of 1.0.

COP (Coefficient of Performance) - Rated BTU capacity divided by total kW input.

INDIVIDUAL ZONING: PERSONALIZED WHOLE-HOME COMFORT

MULTI-ZONE MINI SPLIT SYSTEMS

Halcyon Systems are some of today's most advanced forms of heating and air conditioning. One outdoor unit can operate up to 5 indoor units simultaneously. Fujitsu's Systems are super quiet as well as highly energy efficient.



- Each indoor unit can be operated independently via remote control
- Choose from a variety of indoor unit styles
- Provide both heating and cooling (not simultaneously)
- High energy efficiencies
- Quiet operation

WALL MOUNTED

They mount high on a wall, out of sight and do not require ductwork, increasing energy efficiency.

- Quiet operation
- Easy maintenance
- High delivered efficiency means lower utility bills

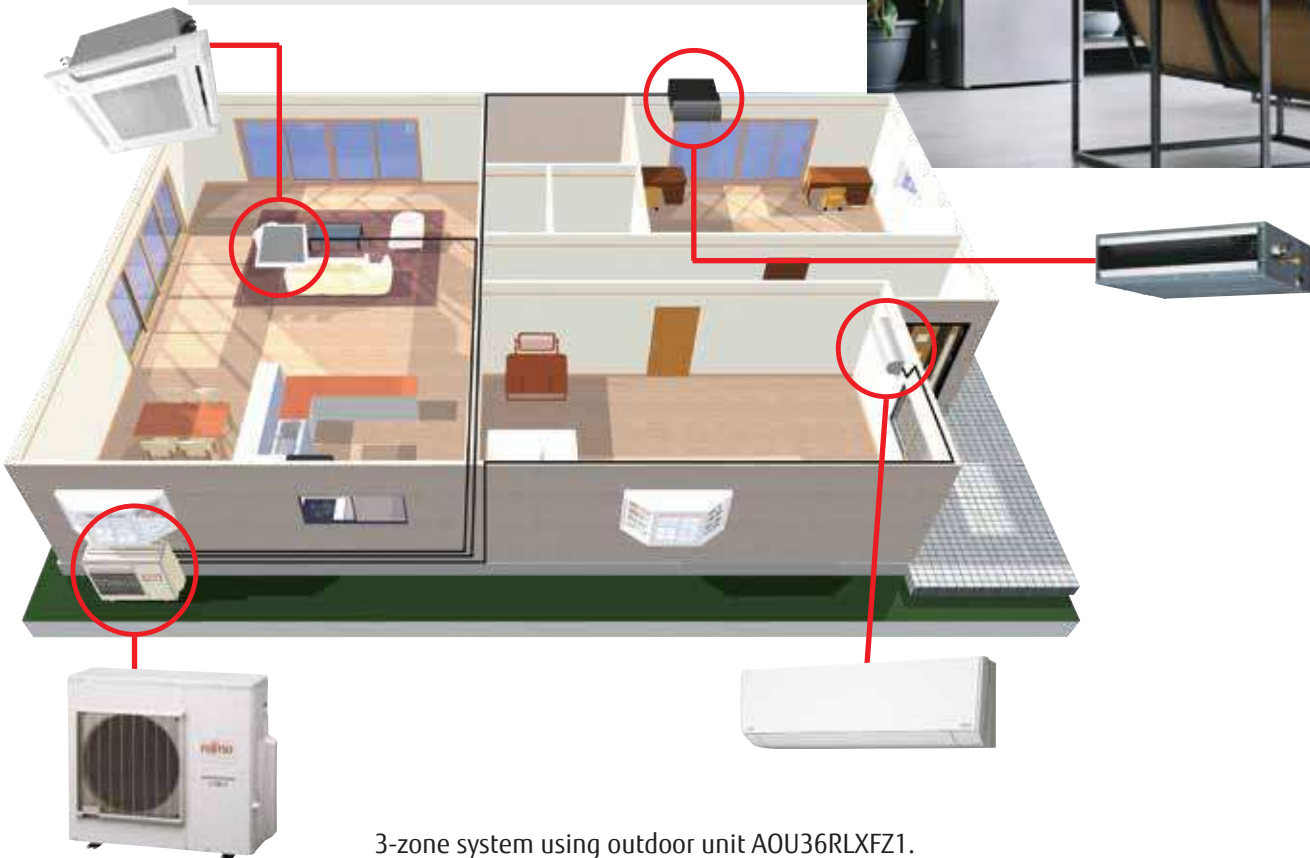

3-zone system using outdoor unit AOU36RLXFZ1.



SLIM DUCT

Installed horizontally above ceiling or vertically within wall space. They use less ductwork and remain very energy efficient.

- Concealed and out of sight
- Horizontal or Vertical Installation
- Less ducts = higher efficiency

FLOOR MOUNTED

Floor mount systems are ideal for residential radiator replacements or any room with limited upper wall space, like a kitchen or sunroom.

- Compact size fits easily under a standard window
- Features twin fan design for improved heat delivery and help those cold feet.
- Designer wireless remote control



COMPACT CASSETTE

Cassettes are extremely discreet, with only the grille showing in the ceiling. They use the latest fan technology to distribute the conditioned air evenly.

- Wired or wireless remote control options
- Powerful turbo fan operation
- Fits into a standard 2' x 2' ceiling grid

A SOLUTION FOR ALL OF YOUR COMFORT NEEDS

DUCTLESS TECHNOLOGY

Fujitsu systems are compact, meaning they install easily and won't take up valuable closet space. Since mini-splits have little or no ducting, they forego energy losses typically associated with central forced-air systems. Duct losses in a central air system can easily account for more than 30% of energy consumption, especially if the ducts are not sealed tightly or installed in an unconditioned space such as an attic or crawlspace.

CENTRAL AIR SYSTEM VERSUS FUJITSU QUAD ZONE

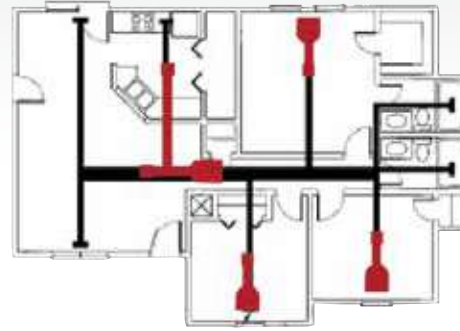

Thick black lines represent ducts of a central air system.

Red lines represent mini-ducts of a Fujitsu Quad Zone Slim Duct System.



WHOLE HOME OR BUSINESS COMFORT

Fujitsu's Halcyon systems provide home and business owners just the right amount of heating and cooling needed by installing 2 to 5 indoor units connected to one outdoor unit. Indoor units vary by size and style, each creating its own "zone" of comfort, allowing you to heat or cool individual rooms, hallways and open spaces.

A YEAR ROUND SOLUTION

Revolutionary Halcyon heat pumps provide both heating and cooling for year round comfort in most climates. A simple push of a button on the remote control allows you to switch from heating to cooling (or vice versa) automatically.

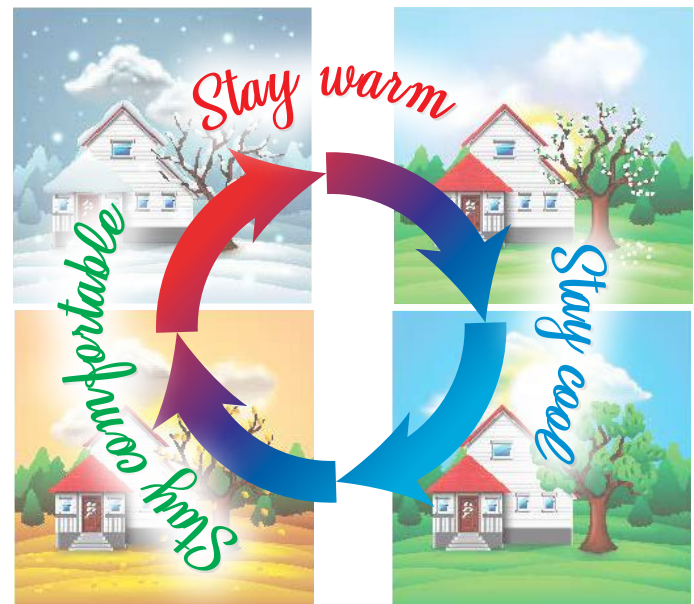

OTHER APPLICATIONS

The 30RLXEH is specially engineered for spaces which require constant cool temperatures year round, and/or rooms that hold a large number of people (meeting spaces, classrooms, conference rooms).

ENERGY EFFICIENT: THE SMART CHOICE IN COMFORT

As much as half of the energy used in your home goes to heating and cooling. So, making smart decisions about your home's heating and air conditioning system can have a big effect on your utility bills – and your comfort.

WHERE DOES MY MONEY GO?

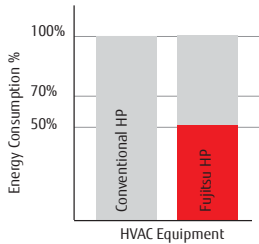

The high energy efficiencies of Halcyon systems slash utility bills by up to 30%. If your average annual utilities are \$4,200, Fujitsu can save you up to \$1,260 annually or \$12,600 in 10 yrs!*

*Savings may vary based on model selected, hours of operation and geographical location. Example given based on 33-SEER system versus 14-SEER system.

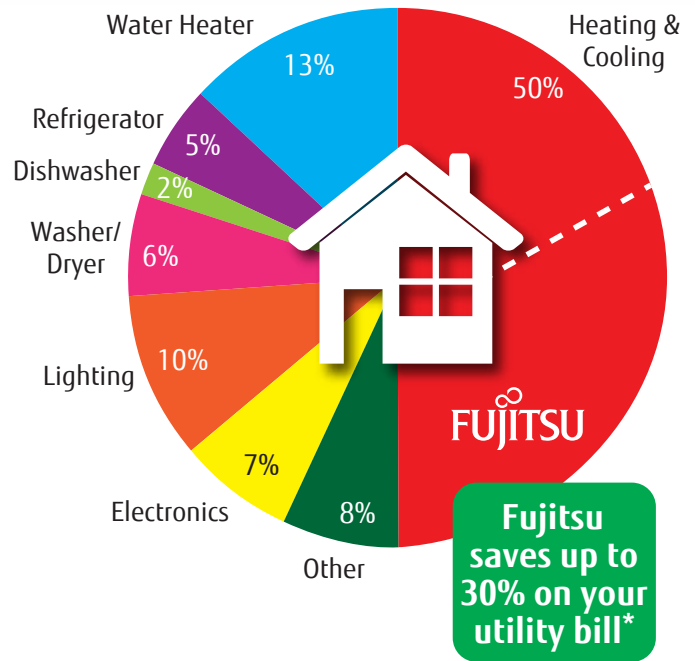

REBATES

To encourage customers to buy energy efficient products, many local utility companies offer significant rebates for the purchase of a ductless mini-split system. Go to Fujitsu's web site to search for local rebates and consumer loans. We provide a listing of rebates and offerings on qualifying Fujitsu mini-splits by zip code.

www.fujitsugeneral.com

ENERGY STAR® QUALIFIED SYSTEMS

If your HVAC equipment is more than 10 years old or not keeping your house comfortable, you should have it looked at by a professional HVAC contractor. If it is not performing efficiently or needs upgrading, consider replacing it with a unit that has earned ENERGY STAR®. Installed correctly, these high-efficiency heating and cooling units can save up to 30% on heating and cooling costs.



Fujitsu has many systems that meet ENERGY STAR and Energy Star Most Efficient ratings in 2021. See the lineup chart on pages 18-19 for a full listing of all ENERGY STAR® qualified systems.



COMFORT AND CONVENIENCE

FLEXIBLE AND QUIET

Mini splits offer flexibility because they can be suspended from a ceiling, mounted flush behind a drop ceiling, hung on a wall or floor-standing. Ductless heat pumps allow for a peaceful inside environment by enabling the contractor to install components like compressors and motors outdoors.

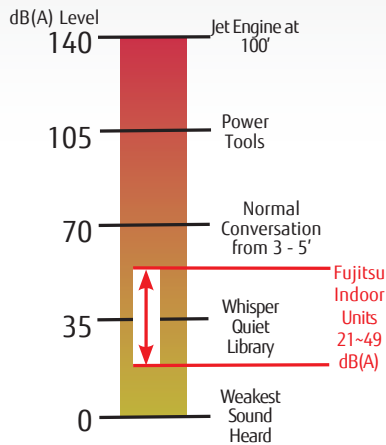

CONSTANT COMFORT THROUGH INVERTER TECHNOLOGY

Inverter technology is like cruise control for your heating or cooling system. Compressors only run as fast as they need to handle the cooling or heating demand. They can handle greater extremes in temperature, are smoother and more stable in operation, and precisely maintain the desired temperature through system modulation.

Inverter Benefits

- More heat at lower outdoor temperatures
- Lower RPM = quieter operation
- Maintains desired temperature
- Up to 30% more efficient
- Stable temperature

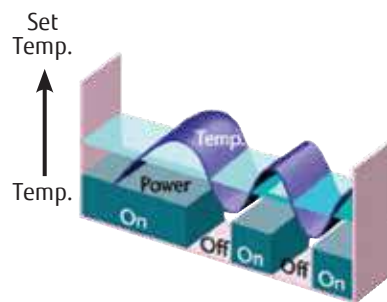

Conventional System

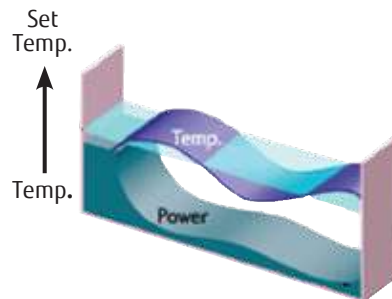

Inverter System

USER FRIENDLY CONTROL

Fujitsu is using ergonomics to expand the use of user friendly designs such as easy-to-read large LCD displays, easy-to-operate buttons, and displays with easily recognizable colors and icons. Our control systems provide greater convenience for both individual and centralized control with operability suitable for the application.

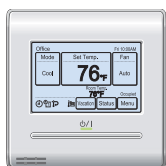

Optional Wired Remote
UTY-RNRUZ Series

Standard Wireless Remote for select systems



APPLICATIONS



WHERE CAN MINI-SPLITS BE USED?

- Convenience stores
- Fast food chains
- Fire houses
- Police stations
- Bars
- Sunrooms and additions
- Warehouses
- Nursing homes
- Small offices
- Older homes
- New construction homes
- Schools
- Places of worship
- Hospitals and medical facilities
- Restaurants
- Hotels and motels
- ATM vestibules
- Historic Buildings

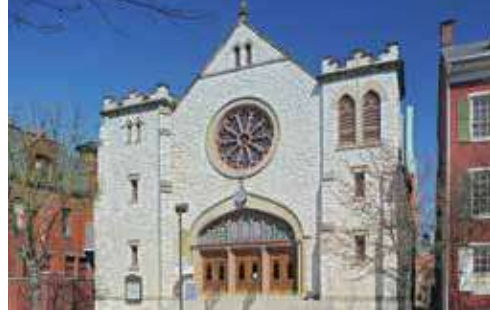

**JUST ABOUT ANY
PLACE THAT
REQUIRES
COMFORT!**

FGLair® APP

Control your home's climate anytime, anywhere!

Access control functions remotely from any smartphone or tablet.



WALL UNIT

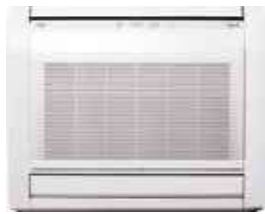

FLOOR UNIT



MEDIUM STATIC DUCTED



MULTI-POSITION AIR HANDLER



SLIM DUCT



LARGE CASSETTE



CEILING CASSETTE

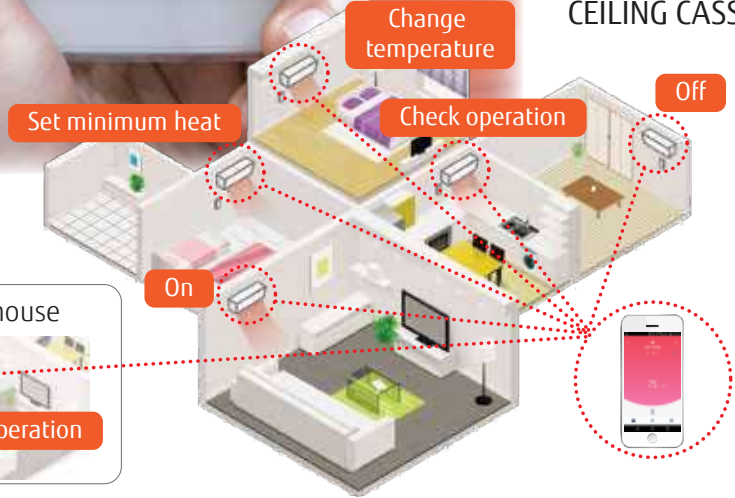

USER FRIENDLY INTERFACE

User friendly screen display facilitates easy operation.



- Individual AC name display
- ON/OFF button
- Room temperature*
- Temperature setting

*Not available with UTY-TFNX22.

Control up to 24 systems using a single free account.









MAIN FUNCTIONS

- ON / OFF
- Operation mode
- Fan speed
- Louver position
- Set temperature control
- Weekly timer
- Minimum heat
- Energy Saving Program
- Error display
- Email notification



FGLair® is worldwide trademark of FUJITSU GENERAL LIMITED.

FUJITSU HALCYON WIFI SELECTION GUIDE

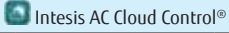
WIFI CONNECTABLE UNITS & MODULES						
 FGLAir®				 Intesis AC Cloud Control®		
						
Built In	Wi-Fi Interface Module		Wi-Fi Interface Module	IR Wireless Module	Wired Module	Wired Module
ASUG 09/12/15 LZAS	UTY-TFNXZ2 (Add-on)	UTY-TFSXZ2 (Add-on)	UTY-TFSXF1 (Add-on)	FJ-IR-WIFI-1NA (Add-on)	FJ-RC-WIFI-1NA (Add-on)	FJ-AC-WIFI-1 (Add-on)
WHICH APP DOES IT USE?						
 FGLAir®				 Intesis AC Cloud Control®		
FGLAIR® APP FEATURES: <ul style="list-style-type: none"> • On/Off • Change Mode • Change Temp Setpoint • Fan Speed • Louver/Swing Position • Weekly Timer • Economy Setting • Emailed Error Alerts NOTE: Room temperature display only available with LZAS1, LZAH1 units and UTY-TFSXZ2 or UTY-TFSXF1.				Intesis AC Cloud Control® APP FEATURES: <ul style="list-style-type: none"> • On/Off • Change Mode • Change Temp Setpoint • Fan Speed • Room Temp (available on FJ-AC-WIFI-1) • Can be used in conjunction with Wired Controls • Louver/Swing Position • Weekly Timer • Fully Programmable • Alarm Notifications • Voice Control / IFTTT 		
App available on iOS and Android.				App available on iOS and Android. Can also be run through a web browser.		
WHERE DOES IT MOUNT?						
Built into the LZAS	On the wall next to IDU	On the wall next to IDU	Mounts inside unit case	Up to 20' away from IDU	On the wall next to IDU	On the wall next to IDU
COMPATIBLE UNITS:						
WALL MOUNTS:	WALL MOUNTS:		WALL MOUNTS:	WALL MOUNTS:	WALL MOUNTS:	WALL MOUNTS:
ASUG 09/12/15LZAS	ASU 7 / 9 / 12 / 15R1F ¹		ASUG 09/12LMAS	ASU 7 / 9 / 12 / 15R1F1	ASU 7 / 9 / 12 / 15R1F1 ^{1,3}	ASU30RLE
	ASU 18 / 24RLF		ASUH09 / 12LMAS [^]	ASU 18 / 24RLF	ASU 18 / 24RLF ³	ASUG09 / 12LMAS
	ASU 18 / 24RLB			ASU 18 / 24RLB	ASU 18 / 24RLB ³	ASUH09 / 12LMAS [^]
	ASU 30 / 36RLXB			ASU 30 / 36RLXB	ASU 30 / 36RLXB ³	
	ASU30RLE					
	CASSETTES:	CASSETTES:		CASSETTES:	CASSETTES:	CASSETTES:
	AUU 7 / 9 / 12 / 18RLF	AUU 18 / 24 / 30 / 36 / 42 / 48RGLX		AUU 7 / 9 / 12 / 18RLF	AUU 7 / 9 / 12 / 18RLF	AUU 18 / 24 / 30 / 36 / 42 / 48RGLX
	DUCTED:	DUCTED:		DUCTED:	DUCTED:	DUCTED:
	ARU 7 / 9 / 12 / 18 / 24RLF	ARU 12 / 18 / 24 / 30 / 36 / 42 / 48RGLX		ARU 7 / 9 / 12 / 18 / 24RLF ²	ARU 7 / 9 / 12 / 18 / 24RLF	ARU 12 / 18 / 24 / 30 / 36 / 42 / 48RGLX
	FLOOR MOUNTS:	FLOOR MOUNTS:		FLOOR MOUNTS:	FLOOR MOUNTS:	FLOOR MOUNTS:
	AMUG 24 / 30 / 36 / 48 LMAS			AMUG 24 / 30 / 36 / 48 LMAS		
	AGU 9 / 12 / 15RLF			AGU 9 / 12 / 15RLF ³		
	UTY-TFNXZ2 cannot be installed in conjunction with Wired Remote Controls.			UNIVERSAL / CEILING:	UNIVERSAL / CEILING:	
				ABU 18 / 24RULX	ABU 18 / 24RULX	
				ABU36RSLX	ABU36RSLX	

¹requires UTY-XCBXZ2 ²requires UTY-LRHUM ³requires UTY-WIFI [^]Coming Q3 2021

VOICE CONTROL FOR YOUR FUJITSU HALCYON SYSTEM USING AMAZON ECHO OR GOOGLE HOME

All Fujitsu Halcyon systems can be voice controlled with Amazon Echo or Google Home speakers.



IFTTT (IF THIS THEN THAT)

Multi system integration through cloud services. Choose from a number of applets to operate your system based on Geo-fencing, Weather conditions, Google Calendar and more.

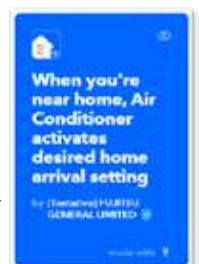

EXTRA LOW TEMPERATURE HEATING - XLTH

NOT ALL HEATING SYSTEMS ARE CREATED EQUAL

Without the right technology, a system won't work when it's needed most.

PROTECTION FROM WINTERS' COLDEST TEMPERATURES

When the temperature drops you don't want to be left in the cold. It's important to choose a heat pump system rated for the climate you live in. If your system doesn't operate in severe conditions, it may not provide enough heat when needed most.

Fujitsu's line of mini-split heat pumps are available in different sizes, styles, and rated outdoor temperatures. The Extra Low Temperature Heating (**XLTH**) Series features outdoor condensing units engineered to operate in temperatures down to -15°F.



HIGH PERFORMANCE HEATING

Fujitsu XLTH units feature a high efficiency, multi-layer heat exchanger and high capacity compressor. This gives our XLTH heat pumps the ability to extract heat even at very low outdoor temperatures. All XLTH models offer superior heating performance down to -15°F outdoor temperatures.

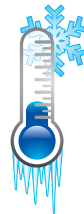

Fujitsu XLTH systems do not have a low temperature lockout, continuing to heat even below -15°F as conditions allow.

METAL FAN GUARD

While other models have a plastic fan guard, XLTH models use metal, which is most capable of withstanding the colder elements.

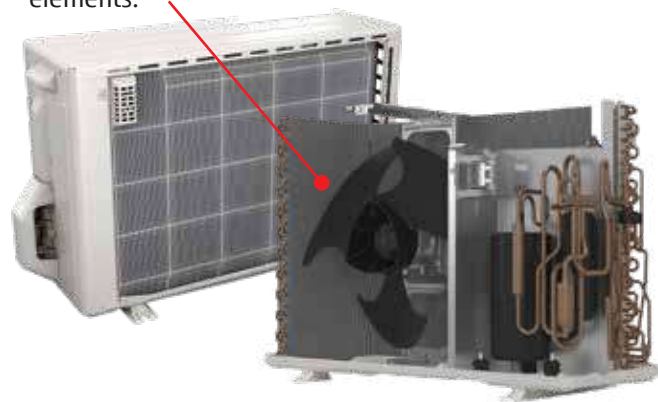

Without the right technology, condensate freezes to the bottom of the unit and reduces its efficiency and heating output.

IMPROVED HEATING CAPACITY

Heating capacity at low outdoor temperatures was improved by adopting a large heat exchanger and a high capacity compressor.

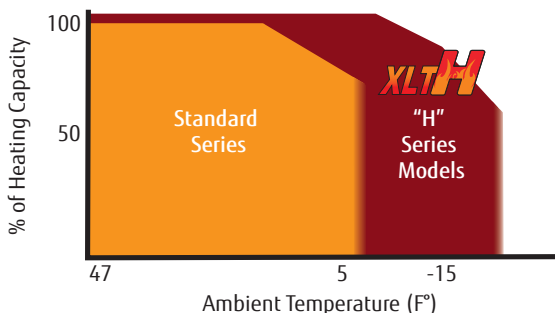

BASE PAN HEATER

- Equipped with a heater that prevents condensate from freezing
- Contoured base design discharges melted water through drain holes.
- Without a heater, freezing condensate can cause noise, damage to fan blades, condenser, and reduced system performance.

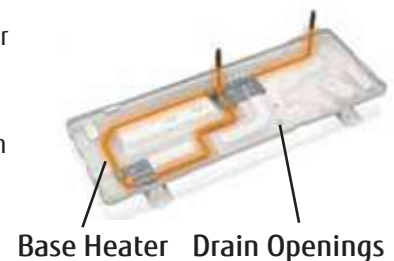

FEATURE EXPLANATION

ENERGY SAVING

SEER

Seasonal Energy Efficiency Rating. Used to express efficiency of an AC or Heat Pump. A higher rating means a more efficient system.

HSPF

Heating Seasonal Performance Factor, measures the efficiency of the heating portion of your heat pump.



Economy Mode

Thermostat setting automatically changes according to the temperature to avoid unnecessary cooling and heating.



Energy Saver

Keeps room cool enough for comfort by using a relaxed thermostat setting reducing power consumption.



Energy Saving Program (ESP)

When the zone is unoccupied for 20 minutes, the ESP function is enabled to reduce energy consumption until occupied once again. Function is not available in multi-zone installations.



ENERGY STAR® Qualified

Qualified products and practices help you save money and reduce greenhouse gas emissions by meeting strict energy efficiency guidelines set by the U.S. Environmental Protection Agency and the U.S. Department of Energy.



Minimum Heat Mode

Sets room temperature to 50°F, keeping temperatures above freezing and reducing power consumption.

COMFORT



Auto Changeover (heating to cooling or vice-versa)*

Automatically alternates between heating or cooling if the room temperature falls 4 °F below the set temperature when cooling or rises 4 °F above set temperature when heating.



Auto Fan Mode

System starts in high fan speed and automatically adjusts downward as room begins to reach set temperature.



Auto Louver: 4 Way

Redirects airflow automatically with up/down and left/right motion.



Auto Louver: Up/Down

Redirects airflow automatically with seven position up and down motion which can be set to auto swing.



Auto Restart

Following a power failure, systems will automatically restart in the same operating mode as before, once power has been restored.



Dry Mode

This mode gives priority to reducing the level of humidity in the room, in conjunction with lowering the temperature.



Fresh Air Intake

Outside air can be introduced by attaching field supplied flexible duct to fresh air knockouts.



Outdoor Unit Low Noise+

Limits compressor and fan speed during high speed operation for noise reduction purposes.



Powerful Operation

20 minutes of continuous operation at maximum airflow and maximum compressor speed. Rapid cooling and heating makes the room comfortable quickly.



Quiet Mode (Indoor Unit)

An extra quiet fan speed to make sure you are not disturbed.

+ Function is bypassed during defrost and at low speed operation. This feature may limit cooling/heating capacity during high/low ambient conditions and increase energy consumption as system may need to operate longer due to reduced compressor speed.

* Auto Changeover is not designed to provide rapid changes between heating and cooling operation or simultaneous heating and cooling. Areas with dissimilar conditioning requirements should be independently zoned.



Standard Warranty

Fujitsu systems come standard with either a 6 Year Compressor / 2 Year Parts warranty or a 7 Year Compressor / 5 Year Parts warranty.



Extended Warranty

Additional info on page 75. See full product warranty for details.

CONVENIENCE



24 Hour Timer

Allows for one on/off cycle during a 24 hour period.



Sleep Timer

Automatically adjusts the temperature while you sleep to make you more comfortable.



Weekly Timer

Allows you to set on/off time twice a day and a different on/off time by day.

PERFORMANCE



Apple Catechin Filter (polyphenol ingredient from apples)

Dust, mold spores and microorganisms are absorbed onto the filter by static electricity and growth is inhibited. 3 - 12 month life expectancy.



Cold Air Prevention

Indoor coil will warm prior to fan operating, preventing cold air during heating mode.



Expanded Heating Performance

Delivers 100% of rated heating capacity at +5°F (-15°C).



High Ceiling Mode

Temperature at the top of a high ceiling room may be warmer than the space occupied; this mode adjusts for this difference.



Ion Deodorizing Filter

Deodorizes by decomposing absorbed odors using the oxidizing and reducing effects of ions generated by fine ceramic particles. 3 year life expectancy. Wash to restore surface action.



Pump Down Operation

Collects all refrigerant in system back into the outdoor unit if the unit needs to be relocated. Eliminates costly refrigerant recovery procedures.



Remote Temperature Sensor

Room temperature sensor is located in optional wired remote control only.



Third Party Device Control

Turns system on or off using a normally closed circuit. Interface with third party devices such as home automation.



0°F Low Ambient Cooling

Can operate in cooling mode with outdoor temperatures as low as 0°F. Cooling performance beyond published temperature ratings is not guaranteed.



-5°F Low Ambient Cooling

Can operate in cooling mode with outdoor temperatures down to -5°F. Cooling performance beyond published temperature ratings is not guaranteed.

INSTALLATION



Base Pan Heater

Prevents condensate from freezing on the outdoor unit.



Blue Fin Coating

Blue Fin treatment to the outdoor unit's heat exchanger improves corrosion resistance.



Hydro Fin Coating

Clear hydrophilic treatment added to the outdoor unit's heat exchanger improves corrosion resistance.



Branch Duct Capable

Systems are capable of attaching field-supplied branch ducts providing up to 38% of the cooling up to 16 feet away.



Build-In Condensate Pump

Integrated into the indoor unit.



Daisy Chain

Ability to connect up to 16 identical style indoor units to one wired remote.



Long Piping Length

Long piping lengths between equipment offers flexible outdoor unit location options.



Slender Fit

Cassette body can be moved downward into the room 1-3/8" to accommodate limited ceiling space.













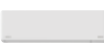





SYSTEM FEATURE SUMMARY

	SINGLE-ZONE HEAT PUMPS																																			
	WALL MOUNT															FLOOR MOUNT					COMPACT CASSETTE		SLIM DUCT													
	9RL2	09LMA51	09LMAH1	09LZAS1	09LZAH1	12RL2	12LMA51	12LMAH1	12LZAS1	12LZAH1	15LZAS1	15LZAH1	18RLB	18RLXFW1	18RLXFWH	24RLB	24RLXFW1	24RLXFWH	30RLXEH	30RLXB	36RLXB	9RLFF	9RLFFH	12RLFF	12RLFFH	15RLFF	15RLFFH	9RLFCC	12RLFCC	18RLFCC	9RLFCD	12RLFCD	18RLFCD			
Economy Mode	●	●	●	●	●	●	●	●	●	●	●	●	●	●	●	●	●	●	●	●	●	●	●	●	●	●	●	●	●	●	●	●	●	●	●	
Energy Saver																																				
Energy Saving Pgm (ESP)				●	●				●	●	●	●							●																	
ENERGY STAR® Qualified	●	●	●	●		●	●	●	●	●	●	●	●	●	●		●	●	●	●			●	●	●	●	●	●	●	●	●	●	●	●	●	
Minimum Heat Mode	●	●	●	●		●	●	●	●	●	●	●	●	●	●	●	●	●	●	●	●	●	●	●	●	●	●	●	▲	▲	▲	▲	▲	▲	▲	
Auto Changeover	●	●	●	●	●	●	●	●	●	●	●	●	●	●	●	●	●	●	●	●	●	●	●	●	●	●	●	●	●	●	●	●	●	●	●	
Auto Fan Mode	●	●	●	●	●	●	●	●	●	●	●	●	●	●	●	●	●	●	●	●	●	●	●	●	●	●	●	●	●	●	●	●	●	●	●	
Auto Louver: 4 Way			●	●					●	●	●	●	●	●	●	●	●	●	●	●	●	●														
Auto Louver: Up/ Down	●	●	●			●	●	●															●	●	●	●	●	●	●	●	●	●	▼	▼	▼	
Auto Restart	●	●	●	●	●	●	●	●	●	●	●	●	●	●	●	●	●	●	●	●	●	●	●	●	●	●	●	●	●	●	●	●	●	●	●	
Dry Mode	●	●	●	●	●	●	●	●	●	●	●	●	●	●	●	●	●	●	●	●	●	●	●	●	●	●	●	●	●	●	●	●	●	●	●	
Fresh Air Intake																												◆	◆	◆	◆	◆	◆	◆	◆	
Outdoor Unit Low Noise			●	●				●	●	●	●								●																	
Powerful Operation	●	●	●	●	●	●	●	●	●	●	●	●							●				●	●	●	●	●	●	●	●	●	●	●	●	●	
Quiet Mode (Indoor Unit)	●	●	●	●	●	●	●	●	●	●	●	●	●	●	●	●	●	●	●	●	●	●	●	●	●	●	●	●	●	●	●	●	●	●	●	
24 Hour Timer	●	●	●	●		●	●	●	●	●	●	●	●	●	●	●	●	●	●	●	●	●	●	●	●	●	●	●	●	●	●	●	●	●	●	
Sleep Timer	●	●	●	●	●	●	●	●	●	●	●	●	●	●	●	●	●	●	●	●	●	●	●	●	●	●	●	●	●	●	●	●	●	●	●	
Weekly Timer	□	□	●	●		□	□	●	●	●	●	●	□	□	●	□	□	●	●	●	□	□	□	□	□	□	□	●	●	●	●	●	●	●	●	
Apple Catechin Filter	●	●	●	●		●	●	●	●	●	●	●	●	●	●	●	●	●	●	●	●	●	●	●	●	●	●	●	●	●	●	●	●	●	●	
Cold Air Prevention	●	●	●	●	●	●	●	●	●	●	●	●	●	●	●	●	●	●	●	●	●	●	●	●	●	●	●	●	●	●	●	●	●	●	●	
Expanded Htg. Performance			●	●				●	●	●	●		●	●	●	●	●	●	●	●	●	●	●	●	●	●	●	●	●	●	●	●	●	●	●	
High Ceiling Mode																												●	●	●						
Ion Deodorizing Filter	●	●	●	●		●	●	●	●	●	●	●	●	●	●	●	●	●	●	●	●	●	●	●	●	●	●	●	●	●	●	●	●	●	●	
Pump Down Operation																			●																	
Remote Temp. Sensor	■	■	■	■		■	■	■	■	■	■	■	□	□	□	□	□	□	□	□	□	□	□	□	□	□	□	□	●	●	●	●	●	●	●	
**Third Party Device Control	○	○	○	○		○	○	○	○	○	○	○	○	○	○	○	○	○	○	○	○	○	○	○	○	○	○	○	○	○	○	○	○	○	○	
0° Low Ambient Clg.																																				
-5° Low Ambient Clg.														●	●		●	●	●	●	●	●														
Base Pan Heater		●	●			●	●	●		●				●	●		●	●	●	●	●	●	●	●	●	●	●	●	●	●	●	●	●	●	●	
Blue Fin Coil Protection													●	●		●	●	●	●	●	●	●	●	●	●	●	●	●	●	●	●	●	●	●	●	
Hydro Fin	●	●	●	●	●	●	●	●	●	●	●	●	●	●	●	●	●	●	●	●	●	●	●	●	●	●	●	●	●	●	●	●	●	●	●	
Branch Duct Capable																																				
Built-In Condensate Pump																												●	●	●	●	●	●	●	●	●
Daisy Chain	■	■	■	■		■	■	■	■	■	■	■	□	□	□	□	□	□	□	□	□	□	□	□	□	□	□	□	●	●	●	●	●	●	●	
Long Piping Length (164'+)													●	●		●	●	●	●	●	●	●	●	●	●	●	●	●	●	●	●	●	●	●		
Slender Fit																																				
Warranty: 6 Yr Comp / 2 Yr Parts																																				
Warranty: up to 12 Yr Comp / Parts	1	1	1	1	1	1	1	1	1	1	1	1	1	1	1	1	1	1	1	1	1	1	1	1	1	1	1	1	1	1	1	1	1	1		

SINGLE-ZONE HEAT PUMPS							MULTI-ZONE HEAT PUMPS																	
MEDIUM STATIC DUCTED				MULTI-POSITION AIR HANDLER			UNIVERSAL FLOOR / CEILING		LARGE CASSETTE															
12RGLXD	18RGLXD	24RGLXD	30RGLXD	36RGLXD	42RGLXD	48RGLXD	24RGLXM	30RGLXM	36LMAST	48LMAST	18RULX	24RULX	36RSLX	18RGLXC	24RGLXC	30RGLXC	36RGLXC	42RGLXC	48RGLXC	Compact Wall (RLF: 7-15k BTU)	Large Wall (RLF: 18, 24k BTU)	Slim Duct	Cassette	Floor Mount
●	●	●	●	●	●	●	●	●	●	□	□	□		●	●	●	●	●	●	●	●	●	●	●
														▽	▽	▽	▽	▽	▽	●*				
●	●	●					●	●	●					●	●	●	●	●	●	●	●	●	●	●
●	●	●	●	●	●	●	●	●	●					●	●	●	●	●	●	●	●	●	●	●
●	●	●	●	●	●	●	●	●	●					●	●	●	●	●	●	●	●	●	●	●
●	●	●	●	●	●	●	●	●	●					●	●	●	●	●	●	●	●	●	●	●
●	●	●	●	●	●	●	●	●	●					●	●	●	●	●	●	●	●	●	●	●
●	●	●	●	●	●	●	●	●	●					●	●	●	●	●	●	●	●	●	●	●
●	●	●	●	●	●	●	●	●	●					●	●	●	●	●	●	●	●	●	●	●
●	●	●	●	●	●	●	●	●	●					●	●	●	●	●	●	●	●	●	●	●
●	●	●	●	●	●	●	●	●	●					●	●	●	●	●	●	●	●	●	●	●
▲	▲	▲	▲	▲	▲	▲	▲	▲	▲					▲	▲	▲	▲	▲	▲	●	●	▲	▲	●
□	□	□	□	□	□	□	□	□	□					□	□	□	□	□	□	□	□	□	□	□
●	●	●	●	●	●	●	●	●	●					●	●	●	●	●	●	●	●	●	●	●
●														●	●	●	●	●	●					
●	●	●	●	●	●	●	●	●	●					●	●	●	●	●	●	●	●	●	●	●
□	□	□	□	□	□	□	□	□	□					□	□	□	□	□	□	■	□	●	●	□
○	○	○	○	○	○	○	○	○	○					○	○	○	○	○	○	○	○	○	○	○
●	●	●	●	●	●	●	●							●	●	●	●	●	●					
●	●	●	●	●	●	●	●	●	●					●	●	●	●	●	●	●	●	●	●	●
●	●	●	●	●	●	●	●	●	●					●	●	●	●	●	●	■	□	●	●	□
	●	●	●	●	●	●	●	●	●					●	●	●	●	●	●					
1	1	1	1	1	1	1	1	1	1					1	1	1	1	1	1	1	1	1	1	1

- Available only with optional wired remote control.
- Available only with optional wired remote controller and optional Interface Kit.
- ▽ Available only with optional part UTY-SHZXC
- ▲ Available only with optional wireless remote control.
- Available only with optional Interface Kit. Operation monitoring and On/Off control only.
- ▼ Available only with optional louver grille UTD-GXS(A/B/C)-W or UTD-GXT(A/B/C)-W
- ◆ Available only with optional Fresh Air Intake Kit.
- * See bottom of page 58 and page 60 for qualifying combinations.
- ** Operation limited to on/off, set point, and mode. Using third party control devices eliminates inverter capabilities.
- ^ SEER and HSPF ratings depend on combination of indoor units and outdoor unit selected.
- + Auto Changeover is not designed to provide rapid changes between heating and cooling operation or simultaneous heating and cooling. This feature is not recommended for systems with more than one indoor unit unless all indoor units have similar heating and cooling requirements and have similar temperature set points. If all indoor units have similar heating and cooling requirements and have similar temperature set points, auto changeover will work.
- 1 Standard warranty is 5 year Parts / 7 year Compressor. 12 year Compressor/Parts warranty applies when properly registered AND installed by a Fujitsu Elite Contractor in a residence. See full warranty for details.







SINGLE-ZONE AND MULTI-ZONE SYSTEMS LINEUP

SINGLE ZONE WALL MOUNTED MINI-SPLITS							
BTU		9,000	12,000	15,000	18,000		
BEST	Wall Mount Highest Efficiency 	★ 14°F -5°F ASUG09LZAS / AOUG09LZAS1	★ 14°F -5°F ASUG12LZAS / AOUG12LZAS1	★ 14°F -5°F ASUG15LZAS / AOUG15LZAS1			
	XLH Wall Mount Extra Low Temp Heating 	★ 14°F -15°F ASUG09LZAS / AOUG09LZAH1	★ 14°F -15°F ASUG12LZAS / AOUG12LZAH1	★ 14°F -15°F ASUG15LZAS / AOUG15LZAH1	★ 14°F -15°F ASU18RLF / AO18RLXFWH		
BETTER	Wall Mount High Efficiency 	★ 14°F 5°F ASUG09LMAS / AOUG09LMAS1	★ 14°F 5°F ASUG12LMAS / AOUG12LMAS1		★ -5°F -5°F ASU18RLF / AO18RLXFW1		
	XLH Wall Mount Extra Low Temp Heating  <small>COMING Q3 21</small>	★ 14°F -15°F ASUH09LMAS / AOUH09LMAH1	★ 14°F -15°F ASUH12LMAS / AOUH12LMAH1				
GOOD	Wall Mount Entry Level 	15°F 15°F ASU9RL2 / AO9RL2	15°F 15°F ASU12RL2 / AO12RL2		★ 14°F 5°F ASU18RLB / AO18RLB		
SINGLE ZONE NON-WALL MOUNTED MINI-SPLITS							
	Floor Mount Highest Efficiency 	★ 14°F -5°F AGU9RLF / AO9RLFF	★ 14°F -5°F AGU12RLF / AO12RLFF	★ 14°F -5°F AGU15RLF / AO15RLFF			
	XLH Floor Mount Extra Low Temp Heating 	★ 14°F -15°F AGU9RLF / AO9RLFFH	★ 14°F -15°F AGU12RLF / AO12RLFFH	★ 14°F -15°F AGU15RLF / AO15RLFFH			
	Compact Cassette 	★ 14°F -5°F AAU9RLF / AO9RLFC	★ 14°F -5°F AAU12RLF / AO12RLFC		14°F -5°F AAU18RLF / AO18RLFC		
	Slim Duct Horizontal/Vertical 	★ 14°F -5°F ARU9RLF / AO9RLFC	★ 14°F -5°F ARU12RLF / AO12RLFC		14°F -5°F ARU18RLF / AO18RLFC		
Infinite Comfort Series	Medium-Static Ducted 		★ 14°F -5°F ARU12RGLX / AO12RLFC		★ -5°F -5°F ARU18RGLX / AO18RGLX		
	Multi-Position Air Handler 						
	Universal Mount / Ceiling Only 				0°F 14°F ABU18RULX / AO18RLX		
	Large Cassette Circular Flow 				★ -5°F -5°F AAU18RGLX / AO18RGLX		
MULTI ZONE DUCTLESS HEAT PUMPS - INDOOR UNITS							
BTU		7,000	9,000	12,000	15,000	18,000	24,000
	Compact Wall Mount 	ASU7RLF1	ASU9RLF1	ASU12RLF1	ASU15RLF1		
	Large Wall Mount 					ASU18RLF	ASU24RLF
	Slim Duct 	ARU7RLF	ARU9RLF	ARU12RLF		ARU18RLF	ARU24RLF
	Compact Cassette 	AUU7RLF	AUU9RLF	AUU12RLF		AUU18RLF	
	Floor Mount 		AGU9RLF	AGU12RLF	AGU15RLF		

★: Energy Star Qualified ■: Minimum Ambient Cooling Temperature ■: Minimum Ambient Heating Temperature

	24,000	30,000	36,000	42,000	48,000
	★ -5°F -15°F ASU24RLF / AOU24RLXFWH	★ -5°F -15°F ASU30RLE / AOU30RLXEH			
	★ -5°F -5°F ASU24RLF / AOU24RLXFW1				
	14°F 5°F ASU24RLB / AOU24RLB	14°F 5°F ASU30RLXB / AOU30RLXB	14°F 5°F ASU36RLXB / AOU36RLXB		
	★ -5°F -5°F ARU24RGLX / AOU24RGLX	-5°F -5°F ARU30RGLX / AOU30RGLX	-5°F -5°F ARU36RGLX / AOU36RGLX	-5°F -5°F ARU42RGLX / AOU42RGLX	-5°F -5°F ARU48RGLX / AOU48RGLX
	-5°F -5°F AMUG24LMAS / AOU24RGLX	-5°F -5°F AMUG30LMAS / AOU30RGLX	14°F -5°F AMUG36LMAS / AOU36LMAS1		14°F -5°F AMUG48LMAS / AOU48LMAS1
	0°F 14°F ABU24RULX / AOU24RLX		0°F 14°F ABU36RSLX / AOU36RLX		
	★ -5°F -5°F AOU24RGLX / AOU24RGLX	-5°F -5°F AOU30RGLX / AOU30RGLX	-5°F -5°F AOU36RGLX / AOU36RGLX	-5°F -5°F AOU42RGLX / AOU42RGLX	-5°F -5°F AOU48RGLX / AOU48RGLX

MULTI ZONE DUCTLESS HEAT PUMPS- OUTDOOR UNITS

BTU	18,000 (2 Indoor Units)	24,000 (2 - 3 Indoor Units)	36,000 (2 - 4 Indoor Units)	45,000 (2 - 5 Indoor Units)
BEST	 XLTH ★ 14°F -15°F AOU18RLXFZH	 XLTH ★ 14°F -15°F AOU24RLXFZH	 XLTH ★ 14°F -15°F AOU36RLXFZH	
BETTER	 ★ 14°F 5°F AOU18RLXFZ	 ★ 14°F 5°F AOU24RLXFZ	 14°F 5°F AOU36RLXFZ1	 14°F 5°F AOU45RLXFZ

+ For ENERGY STAR® qualified combinations, see page 58 and page 60.

SINGLE-ZONE MINI-SPLIT SYSTEMS

Making the hottest places cool and the coolest places more comfortable

- Extensive lineup from 9,000 to 48,000 BTU
- 32 different systems available in 7 indoor unit styles
- Energy efficient systems with SEER ratings as high as 33.1 and HSPF as high as 14.2
- 29 ENERGY STAR® qualified systems
- Inverter Technology is used in all systems
- All systems feature environmentally friendly R410A refrigerant
- Quiet operation with indoor units as low as 19dB(A) and outdoor units as low as 46dB(A)

9, 12, 15,000 BTU/h WALL MOUNT HEAT PUMPS

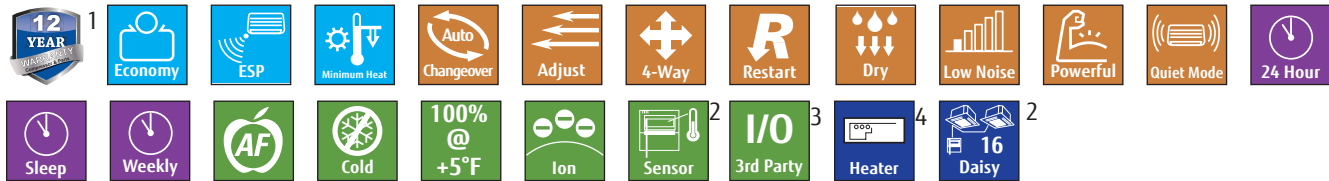

- 1 Applies when properly registered AND installed by a Fujitsu Elite Contractor in a residence. See full warranty for details.
- 2 Available only with optional wired Remote Control and optional interface kit.
- 3 Available only with optional interface kit. Operation monitoring and On/Off control only.
- 4 XLTH models only

ENERGY SAVING PROGRAM (ESP) FUNCTION

With the ESP function, the ASUG* LZAS system actively monitors occupancy and adjusts system settings accordingly to achieve optimum energy savings.

Once the system detects an occupant, the settings are reverted to the user defined settings in order to maintain comfort.

HIGH PERFORMANCE HEATING

The LZAS1 model can operate down to -5°F. The LZAH1 can operate down to -15°F. See the full XLTH story on page 14.

BUILT-IN WI-FI

Remotely operate your heating and cooling system using a smartphone as a remote control. Details on page 12



OPTIONAL ACCESSORIES

- Wired Remote Controller UTY-RNRUZ Series
- Simple Remote Controller UTY-RSRY / UTY-RHRY
- Communication Kit..... UTY-TWRXZ2
- External Input and Output PCB.....UTY-XCSXZ2
- Thermostat Converter.....UTY-TTRX

SYSTEMS 09LZAS1, 12LZAS1, 15LZAS1 HIGH HEAT SYSTEMS 09LZAH1, 12LZAH1, 15LZAH1

UP TO 33.1 SEER

09LZAS1



12LZAS1



15LZAS1



09LZAH1



12LZAH1



15LZAH1



Performance		09LZAS1		12LZAS1		15LZAS1		09LZAH1		12LZAH1		15LZAH1	
Nominal Cooling	BTUh	9,000		12,000		14,500		9,000		12,000		14,500	
Min.-Max. Cooling	BTUh	3,100~12,000		3,100~13,600		3,100~18,400		3,100~12,000		3,100~13,600		3,100~18,400	
Nominal Heating	BTUh	12,000		16,000		18,000		12,000		16,000		18,000	
Min.-Max. Heating	BTUh	3,100~22,000		3,100~22,100		3,100~23,900		3,100~22,000		3,100~22,100		3,100~23,900	
SEER		33.1		29.4		25.3		33.1		29.4		25.3	
HSPF		14.2		14.0		13.4		14.0		13.8		13.3	
EER		18.0		15.2		13.9		18.0		15.2		13.9	
Cooling Operating Range	°F (°C)	14~115 (-10~46)		14~115 (-10~46)		14~115 (-10~46)		14~115 (-10~46)		14~115 (-10~46)		14~115 (-10~46)	
Heating Operating Range	°F (°C)	-5~75 (-21~24)		-5~75 (-21~24)		-5~75 (-21~24)		-15~75 (-26~24)		-15~75 (-26~24)		-15~75 (-26~24)	
Moisture Removal	Pt./h (l/h)	2.5 (1.2)		2.7 (1.3)		4.0 (1.9)		2.5 (1.2)		2.7 (1.3)		4.0 (1.9)	
Max Htg % of Nominal Capacity at +5°F (-15°C)*		171%		138%		140%		171%		138%		140%	
Max Htg % of Nominal Capacity at -5°F (-21°C)*		156%		125%		124%		156%		125%		124%	
Max Htg % of Nominal Capacity at -15°F (-26°C)*		--		--		--		123%		98%		109%	
Fan (Cooling Mode)													
Air Circulation: Hi	CFM (m3/h)	542 (920)		542 (920)		583 (990)		542 (920)		542 (920)		583 (990)	
Medium	CFM (m3/h)	406 (690)		406 (690)		459 (780)		406 (690)		406 (690)		459 (780)	
Low	CFM (m3/h)	312 (530)		312 (530)		312 (530)		312 (530)		312 (530)		312 (530)	
Quiet	CFM (m3/h)	206 (350)		206 (350)		241 (410)		206 (350)		206 (350)		241 (410)	
Fan Speed Stage		4+Auto		4+Auto		4+Auto		4+Auto		4+Auto		4+Auto	
Sound													
Indoor Level (Clg/Htg): Hi	dB(A)	43/43		43/43		45/45		43/43		43/43		45/45	
Medium	dB(A)	37/36		37/36		40/39		37/36		37/36		40/39	
Low	dB(A)	31/31		31/31		32/32		31/31		31/31		32/32	
Quiet	dB(A)	23/23		23/23		26/26		23/23		23/23		26/26	
Outdoor Level Clg/Htg	dB(A)	46/47		47/47		49/50		46/47		47/47		49/50	
Electrical													
Voltage/Frequency/Phase		208-230/60/1		208-230/60/1		208-230/60/1		208-230/60/1		208-230/60/1		208-230/60/1	
Circuit Breaker	Amps	15		15		20		15		15		20	
Current Rated/Max: Cooling	Amps	2.5/9.4		3.8/9.4		4.8/9.9		2.5/9.4		3.8/9.4		4.8/9.9	
Current Rated/Max: Heating	Amps	3.3/10.9		4.7/10.9		5.2/13.4		3.3/11.9		4.7/11.9		5.2/14.4	
Power Use Rated/Max: Cooling	kW	0.50/0.85		0.79/0.99		1.04/1.56		0.50/0.85		0.79/0.99		1.04/1.56	
Power Use Rated/Max: Heating	kW	0.66/1.93		1.01/1.94		1.15/2.19		0.66/1.93		1.01/1.94		1.15/2.19	
Size & Weight													
Net Weight	lbs. (kg)	29 (13)	84 (38)	29 (13)	84 (38)	29 (13)	86 (39)	29 (13)	86 (39)	29 (13)	86 (39)	29 (13)	88 (40)
Dimensions: Height	Inch	11	24-7/8	11	24-7/8	11	24-7/8	11	24-7/8	11	24-7/8	11	24-7/8
	mm	280	632	280	632	280	632	280	632	280	632	280	632
Width	Inch	38-9/16	31-7/16	38-9/16	31-7/16	38-9/16	31-7/16	38-9/16	31-7/16	38-9/16	31-7/16	38-9/16	31-7/16
	mm	980	799	980	799	980	799	980	799	980	799	980	799
Depth	Inch	9-7/16	11-7/16	9-7/16	11-7/16	9-7/16	11-7/16	9-7/16	11-7/16	9-7/16	11-7/16	9-7/16	11-7/16
	mm	240	290	240	290	240	290	240	290	240	290	240	290
Refrigerant		R410A		R410A		R410A		R410A		R410A		R410A	
Additional Data													
Air Direction: Horizontal		Automatic		Automatic		Automatic		Automatic		Automatic		Automatic	
Vertical		Automatic		Automatic		Automatic		Automatic		Automatic		Automatic	
Air Filter		Washable		Washable		Washable		Washable		Washable		Washable	
Minimum Lineset Length	Ft (m)	16 (5)		16 (5)		16 (5)		16 (5)		16 (5)		16 (5)	
Maximum Lineset Length	Ft (m)	66 (20) (pre-charge: 49')		66 (20) (pre-charge: 49')		66 (20) (pre-charge: 49')		66 (20) (pre-charge: 49')		66 (20) (pre-charge: 49')		66 (20) (pre-charge: 49')	
Max. Vertical Diff.	Ft (m)	49 (15)		49 (15)		49 (15)		49 (15)		49 (15)		49 (15)	
Lineset Size	Inch	Gas 3/8	Liq. 1/4	Gas 3/8	Liq. 1/4	Gas 1/2	Liq. 1/4	Gas 3/8	Liq. 1/4	Gas 3/8	Liq. 1/4	Gas 1/2	Liq. 1/4
		Indoor ASUG09LZAS	Outdoor AOUG09LZAS1	Indoor ASUG12LZAS	Outdoor AOUG12LZAS1	Indoor ASUG15LZAS	Outdoor AOUG15LZAS1	Indoor ASUG09LZAS	Outdoor AOUG09LZAH1	Indoor ASUG12LZAS	Outdoor AOUG12LZAH1	Indoor ASUG15LZAS	Outdoor AOUG15LZAH1

* Based on model # capacity class (e.g. 09LZAS1 based on 9,000 BTUh) @ 70°F indoor setpoint. Refer to the Design & Technical Manual for expanded heating capacity data.

Note: Figures are based on 230 Volts.

9 AND 12,000 BTU_h WALL MOUNT HEAT PUMPS

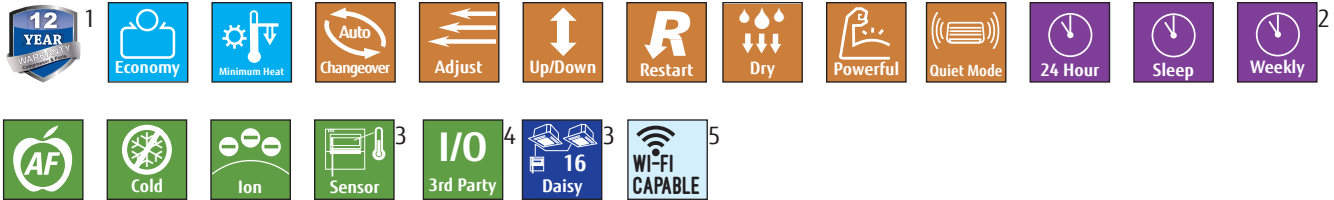

1 Applies when properly registered AND installed by a Fujitsu Elite Contractor in a residence. See full warranty for details.
 2 Available only with optional wired remote control.
 3 Available only with optional wired remote control and optional interface kit.

4 Available only with optional interface kit. Operation monitoring and On/Off control only.
 5 See page 13 for details.

BUILT IN FILTRATION

LONG-LIFE ION DEODORIZATION FILTER



The filter deodorizes by powerfully decomposing absorbed odors using the oxidizing and reducing effects of ions generated by the ultra-fine particle ceramic. The filter can be used for approximately 3 years if it is washed with water when dirty to restore its surface action.



APPLE-CATECHIN FILTER

Dust, mold spores and micro-organisms are absorbed onto the filter by static electricity and growth is inhibited and deactivated. Filter lasts 3-12 months.

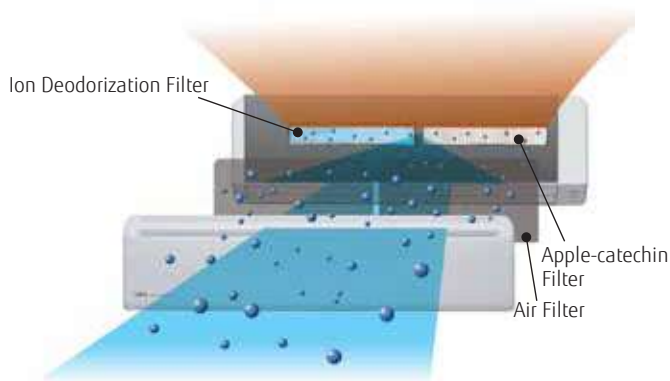

EXTRA LOW TEMP HEATING - COMING Q3 21 ✨

LMAH1 models operate efficiently and provide high heating capacity down to -15°F, ideal for cold climate applications. See the full *xtH* story on page 14.

OPTIONAL ACCESSORIES

Wired Remote Controller	UTY-RNRUZ Series
Simple Remote Controller	UTY-RSRY / UTY-RHRY
Wireless LAN Interface	UTY-TXSFX1
Thermostat Converter.....	UTY-TTRX
External Input and Output PCB.....	UTY-XCSXZ2
External Connect Kit.....	UTY-XWZXZ5
Communication Kit.....	UTY-TWRXZ2

STRENGTH AND RELIABILITY

Improved reliability is achieved by using HCRC (High Corrosion Resistant Copper) for the indoor unit heat exchanger. Testing has proven to show that HCRC is resilient and stronger than the standard and OFC (Oxygen Free Copper) when exposed to corrosive environments.



COMING Q3 21 - HIGH HEAT

SYSTEMS 09LMAS1, 12LMAS1 SYSTEMS 09LMAH1, 12LMAH1

UP TO 26.5 SEER

09LMAS1



12LMAS1



09LMAH1



12LMAH1



Performance		09LMAS1		12LMAS1		09LMAH1		12LMAH1	
Nominal Cooling	BTUh	9,000		12,000		9000		12000	
Min.-Max. Cooling	BTUh	3,400-10,900		3,400-13,300		3,400-13,500		3,400-13,300	
Nominal Heating	BTUh	12,000		16,000		12000		16000	
Min.-Max. Heating	BTUh	2,800-15,000		2,800-19,100		2,800-16,000		2,800-19,100	
SEER		26.5		23.0		26.5		23	
HSPF		13.0		12.5		13		12.5	
EER		14.3		12.5		15.4		12.5	
Cooling Operating Range	°F (°C)	14~115 (-10~46)		14~115 (-10~46)		14 to 115 (-10 to 46)		14 to 115 (-10 to 46)	
Heating Operating Range	°F (°C)	5~75 (-15~24)		5~75 (-15~24)		-15 to 75 (-26 to 24)		-15 to 75 (-26 to 24)	
Moisture Removal	Pt./h (l/h)	2.7 (1.3)		3.8 (1.8)		2.7 (1.3)		3.8 (1.8)	
Fan (Cooling Mode)									
Air Circulation: Hi	CFM (m3/h)	453 (770)		453 (770)		453 (770)		453 (770)	
Medium	CFM (m3/h)	353 (600)		353 (600)		353 (600)		353 (600)	
Low	CFM (m3/h)	265 (450)		265 (450)		265 (450)		265 (450)	
Quiet	CFM (m3/h)	147 (250)		147 (250)		147 (250)		147 (250)	
Fan Speed Stage		4+Auto		4+Auto		4+Auto		4+Auto	
Sound									
Indoor Sound Level (Clg/Htg): Hi	dB(A)	43/43		43/43		43/43		43/43	
Medium	dB(A)	36/38		36/38		36/38		36/38	
Low	dB(A)	30/33		30/33		30/33		30/33	
Quiet	dB(A)	19/21		19/21		19/21		19/21	
Outdoor Sound Level Clg/Htg	dB(A)	46/48		49/51		46/48		49/51	
Electrical									
Voltage/Frequency/Phase		208-230/60/1		208-230/60/1		208-230/60/1		208-230/60/1	
Circuit Breaker	Amps	15		15		15		15	
Current Rated/Max: Cooling	Amps	3.1/6.4		4.7/6.9		3/6.9		4.7/6.9	
Current Rated: Heating	Amps	4.0/7.9		6.0/9.4		3.9/9.4		6/9.4	
Power Use Rated/Max: Cooling	kW	0.63/0.92		0.96/1.27		0.585/1.27		0.96/1.27	
Power Use Rated/Max: Heating	kW	0.84/1.61		1.28/1.67		0.79/1.67		1.28/1.67	
Size & Weight									
Net Weight	lbs. (kg)	22 (10)	68 (31)	22 (10)	71 (32)	22 (10)	73 (33)	22 (10)	73 (33)
Dimensions: Height	Inch	10-5/8	21-5/16	10-5/8	21-5/16	10-5/8	21- 5/16	10-5/8	21- 5/16
	mm	270	542	270	542	270	542	270	542
Width	Inch	32-13/16	31-7/16	32-13/16	31-7/16	32-13/16	31- 7/16	32-13/16	31- 7/16
	mm	834	799	834	799	834	799	834	799
Depth	Inch	8-3/4	11-7/16	8-3/4	11-7/16	8-3/4	11- 7/16	8-3/4	11- 7/16
	mm	222	290	222	290	222	290	222	290
Refrigerant		R410A		R410A		R410A		R410A	
Additional Data									
Air Direction: Horizontal		Manual		Manual		Manual		Manual	
Vertical		Automatic		Automatic		Automatic		Automatic	
Air Filter		Washable		Washable		Washabale		Washabale	
Minimum Lineset Length	Ft (m)	16 (5)		16 (5)		16 (5)		16 (5)	
Maximum Lineset Length	Ft (m)	66 (20) (pre-charge: 49')		66 (20) (pre-charge: 49')		66 (20) (pre-charge: 49')		66 (20) (pre-charge: 49')	
Max. Vertical Diff.	Ft (m)	49 (15)		49 (15)		49 (15)		49 (15)	
Lineset Size	Inch	Gas 3/8	Liq. 1/4	Gas 3/8	Liq. 1/4	Gas 3/8	Liq. 1/4	Gas 3/8	Liq. 1/4
		Indoor ASUG09LMAS	Outdoor AOUG09LMAS1	Indoor ASUG12LMAS	Outdoor AOUG12LMAS1	Indoor ASUH09LMAH1	Outdoor AOUH09LMAH1	Indoor ASUH12LMAH1	Outdoor AOUH12LMAH1

Note: Figures are based on 230 Volts.

18 AND 24,000 BTU_h WALL MOUNT HEAT PUMPS

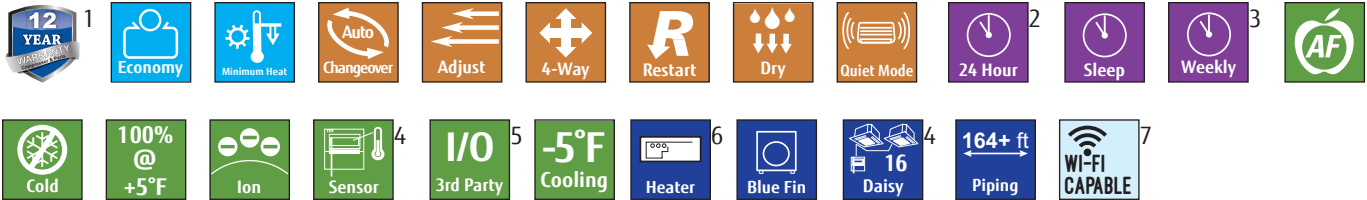

1 Applies when properly registered AND installed by a Fujitsu Elite Contractor in a residence. See full warranty for details.
 2 RLXFW1 systems only.
 3 RLXFW1 systems require optional wired remote control.

4 Available only with optional wired remote control.
 5 Available only with optional Interface kit. Operation monitoring and On/Off control only.
 6 RLXFWH models only.
 7 See page 13 for details.

HIGH PERFORMANCE HEATING CAPACITY

Stay comfortable at low ambient temperatures! The RLXFW1 systems can deliver 100% or more of rated heating capacity at 5°F (-15°C) and operates down to -5°F (-21°C).

The RLXFWH model can operate down to -15°F. See the full **XLTH** story on page 14.

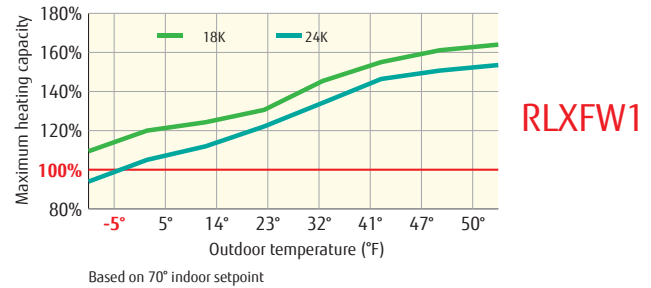

OPTIONAL ACCESSORIES

Wired Remote Control	UTY-RVNUM
Wired Remote Control	UTY-RNNUM
Simple Remote Control.....	UTY-RSNUM
Dry Contact Wire Kit	UTY-XWZX
Wi-Fi Interface Module	UTY-TFNXZZ

RLXFWH

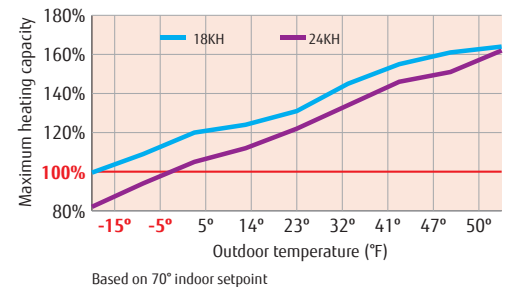

SYSTEMS 18RLXFW1, 24RLXFW1 HIGH HEAT SYSTEMS 18RLXFWH, 24RLXFWH

UP TO 20 SEER

18RLXFW1



24RLXFW1



18RLXFWH



24RLXFWH



Performance						XLH		XLH	
Nominal Cooling	BTUh	18,000		22,000		18,000		22,000	
Min.-Max. Cooling	BTUh	7,000~23,000		9,900~27,300		7,000~23,000		9,900~27,300	
Nominal Heating	BTUh	21,600		25,200		21,600		25,200	
Min.-Max. Heating	BTUh	7,000~29,000		7,500~36,200		7,000~29,000		7,500~36,200	
SEER		20.0		19.5		20.0		19.5	
HSPF		10.5		10.6		10.4		10.5	
EER		13.3		12.5		13.3		12.5	
Cooling Operating Range	°F (°C)	-5~115 (-20~46)		-5~115 (-20~46)		-5~115 (-20~46)		-5~115 (-20~46)	
Heating Operating Range	°F (°C)	-5~75 (-20~24)		-5~75 (-20~24)		-15~75 (-26~24)		-15~75 (-26~24)	
Moisture Removal	Pt./h (l/h)	5.9 (2.8)		6.3 (3.0)		5.9 (2.8)		6.3 (3.0)	
Max Htg % of Nominal Capacity at +5°F (-15°C)*		120%		105%		120%		105%	
Max Htg % of Nominal Capacity at -5°F (-21°C)*		109%		94%		109%		94%	
Max Htg % of Nominal Capacity at -15°F (-26°C)*		-		-		100%		82%	
Fan (Cooling Mode)									
Air Circulation: Hi	CFM (m3/h)	541 (920)		659 (1,120)		541 (920)		659 (1,120)	
Medium	CFM (m3/h)	435 (740)		530 (900)		435 (740)		530 (900)	
Low	CFM (m3/h)	365 (620)		435 (740)		365 (620)		435 (740)	
Quiet	CFM (m3/h)	306 (520)		365 (620)		306 (520)		365 (620)	
Fan Speed Stage		4+Auto		4+Auto		4+Auto		4+Auto	
Sound									
Indoor Level (Clg/Htg): Hi	dB(A)	43/44		49/49		43/44		49/49	
Medium	dB(A)	37/37		42/42		37/37		42/42	
Low	dB(A)	33/33		37/37		33/33		37/37	
Quiet	dB(A)	28/28		33/33		28/28		33/33	
Outdoor Level Clg/Htg	dB(A)	47/50		54/55		47/50		54/55	
Electrical									
Voltage/Frequency/Phase		208-230/60/1		208-230/60/1		208-230/60/1		208-230/60/1	
Circuit Breaker	Amps	20		30		20		20	
Current Rated/Max: Cooling	Amps	6.2/13.5		7.9/15.0		6.2/13.5		7.9/15	
Current Rated/Max: Heating	Amps	7.8/14.5		8.6/15.5		7.8/14.5		8.6/15.5	
Power Use Rated/Max: Cooling	kW	1.35/3.01		1.76/3.42		1.35/3.01		1.76/3.42	
Power Use Rated/Max: Heating	kW	1.80/3.23		2.38/3.53		1.75/3.23		1.94/3.53	
Size & Weight									
Net Weight	lbs. (kg)	31 (14)	134 (61)	31 (14)	134 (61)	31 (14)	135 (61)	31 (14)	135 (61)
Dimensions: Height	Inch	12-5/8	32-3/4	12-5/8	32-3/4	12-5/8	32-3/4	12-5/8	32-3/4
	mm	320	830	320	830	320	830	320	830
Width	Inch	39-1/4	35-3/8	39-1/4	35-3/8	39-1/4	35-3/8	39-1/4	35-3/8
	mm	998	900	998	900	998	900	998	900
Depth	Inch	9	13	9	13	9	13	9	13
	mm	228	330	228	330	228	330	228	330
Refrigerant		R410A		R410A		R410A		R410A	
Additional Data									
Air Direction: Horizontal		Automatic		Automatic		Automatic		Automatic	
Vertical		Automatic		Automatic		Automatic		Automatic	
Air Filter		Washable		Washable		Washable		Washable	
Minimum Lineset Length	Ft (m)	16 (5)		16 (5)		16 (5)		16 (5)	
Maximum Lineset Length	Ft (m)	164 (50) (pre-charge: 66')		164 (50) (pre-charge: 66')		164 (50) (pre-charge: 65')		164 (50) (pre-charge: 65')	
Max. Vertical Diff.	Ft (m)	98 (30)		98 (30)		98 (30)		98 (30)	
Lineset Size	Inch	Gas 5/8	Liq. 3/8	Gas 5/8	Liq. 3/8	Gas 5/8	Liq. 3/8	Gas 5/8	Liq. 3/8

* Based on model # capacity class (e.g. 9RLS3Y based on 9,000 BTUh) @ 70°F indoor setpoint. Refer to the Design & Technical Manual for more heating capacity data.

Indoor ASU18RLF

Outdoor AOU18RLXFW1

Indoor ASU24RLF

Outdoor AOU24RLXFW1

Indoor ASU18RLF

Outdoor AOU18RLXFWH

Indoor ASU24RLF

Outdoor AOU24RLXFWH

Note: Figures are based on 230 Volts.

30,000 BTU_h WALL MOUNT HEAT PUMP

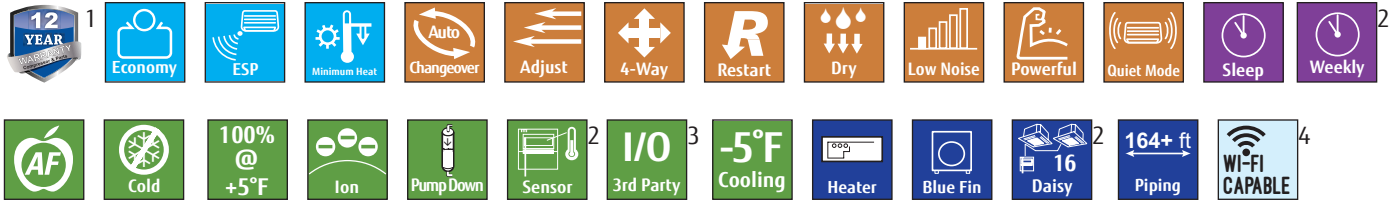

1 Applies when properly registered AND installed by a Fujitsu Elite Contractor in a residence. See full warranty for details.
 2 Available only with optional wired remote control.
 3 Available only with optional Interface kit.
 4 See page 13 for details.

The 30RLXEH is specially engineered for applications that require cooling year round, and/or rooms with large heat loads such as classrooms and conference rooms.

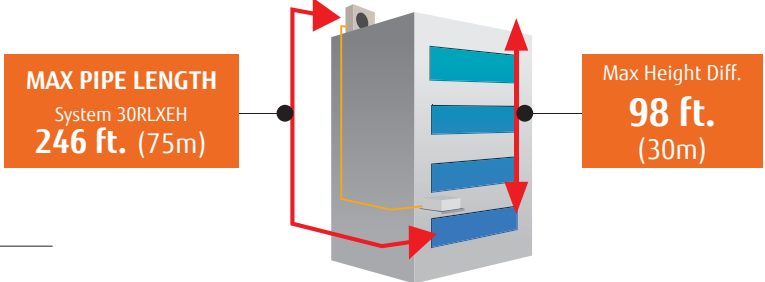

EXTENDED LINESET

Long piping lengths between indoor and outdoor units provide flexibility and increased applications.

LEAD-LAG FUNCTION

Lead-lag function provides a redundant cooling system by pairing two 30RLXEH systems together delivering a unique solution for many applications.[^]

Lead-lag function provides the following operation modes:

- Alternative Operation – units alternate operation, so neither unit is running at the same time.
- Emergency Operation – if an error occurs on one unit, the second unit will turn on.*
- Supporting Operation – if the setpoint cannot be reached with one unit alone, the second unit will come on to satisfy the demand for cooling.

LOCK OUT FUNCTION

This feature is set by the contractor on behalf of the Commercial Property Owner to prevent either Cooling or Heating operation from occurring. This is not a function that can be set by a tenant, user or home owner.

[^] Wired remotes cannot be used when using this feature. This includes UTY-RNRUZ Series, UTY-RVNUM, UTY-RNNUM, UTY-RSNUM.
 * Power loss to one of the two units will disengage the lead lag function.

HIGH PERFORMANCE HEATING CAPACITY

The RLXEH model can operate down to -15°F. See the full **XLTH** story on page 14.

ADDITIONAL APPLICATIONS THAT MAY REQUIRE LOW AMBIENT COOLING:

- Conference/Meeting/Training Rooms
- Social Gathering spots
- Places of Worship

OPTIONAL ACCESSORIES

Wi-Fi Interface Module	UTY-TFNXZ2 [^]
Wi-Fi Interface Module	UTY-TFSXZ2
Wired Touch Panel Remote Controller	UTY-RNRUZ Series
Wired Remote Control	UTY-RVNUM
Wired Remote Control	UTY-RNNUM
Simple Remote Control.....	UTY-RSNUM
Interface Kit	UTY-XCSXZ1
Interface Kit Box.....	UTZ-GXXB
Outdoor Unit Input/Output Connector	UTY-XWZXZ3

HIGH-HEAT SYSTEM 30RLXEH

UP TO 18.7 SEER

30RLXEH



XLH

Performance			
Nominal Cooling	BTUh	30,000	
Min.-Max. Cooling	BTUh	9,900~32,400	
Nominal Heating	BTUh	32,000	
Min.-Max. Heating	BTUh	8,000~37,500	
SEER		18.7	
HSPF		11.7	
EER		12.5	
Cooling Operating Range	°F (°C)	-5~115 (-20~46)	
Heating Operating Range	°F (°C)	-15~75 (-26~24)	
Moisture Removal	Pt./h (l/h)	9.7 (4.6)	
Max Htg % of Nominal Capacity at +5°F (-15°C)*		107%	
Max Htg % of Nominal Capacity at -5°F (-21°C)*		91%	
Max Htg % of Nominal Capacity at -15°F (-26°C)*		76%	
Fan (Cooling Mode)			
Air Circulation: Hi	CFM (m3/h)	812 (1,380)	
Medium	CFM (m3/h)	665 (1,130)	
Low	CFM (m3/h)	536 (910)	
Quiet	CFM (m3/h)	418 (710)	
Fan Speed Stage		4+Auto	
Sound			
Indoor Sound Level (Clg/Htg): Hi	dB(A)	50/49	
Medium	dB(A)	45/44	
Low	dB(A)	38/38	
Quiet	dB(A)	32/32	
Outdoor Sound Level Clg/Htg	dB(A)	53/54	
Electrical			
Voltage/Frequency/Phase		208-230/60/1	
Circuit Breaker	Amps	30	
Current Rated: Cooling	Amps	10.6	
Current Rated: Heating	Amps	12.0	
Power Use Rated/Max: Cooling	kW	2.40/3.83	
Power Use Rated/Max: Heating	kW	2.74/4.28	
Size & Weight			
Net Weight	lbs. (kg)	40 (18)	205 (93)
	Inch	13-3/8	50-13/16
Dimensions: Height	mm	340	1,290
	Inch	45-1/4	35-3/8
Width	mm	1,150	900
	Inch	11	13
Depth	mm	280	330
Refrigerant		R410A	
Additional Data			
Air Direction: Horizontal		Automatic	
Vertical		Automatic	
Air Filter		Washable	
Minimum Lineset Length	Ft (m)	16 (5)	
Maximum Lineset Length	Ft (m)	246 (75) (pre-charge: 65')	
Max. Vertical Diff.	Ft (m)	98 (30)	
Lineset Size	Inch	Gas 5/8	Liq. 3/8
*Based on model # capacity class (e.g. 09LZAS1 based on 9,000 BTUh) @ 70°F indoor setpoint. Refer to the Design & Technical Manual for more heating capacity data.		Indoor ASU30RLE	Outdoor AOU30RLXEH

Note: Figures are based on 230 Volts.

9 AND 12,000 BTUh, 115V, WALL MOUNT HEAT PUMPS



1 Applies when properly registered AND installed by a Fujitsu Elite Contractor in residence. See full warranty for details.

2 See page 13 for details.

FUNCTION

Stylish, slim and elegant, these popular wall mounted units are designed for single rooms. Indoor units have a clean, aesthetic design and are small but mighty and shorter in length than competing units, helping them blend into any room.

EASY MAINTENANCE

Front panel is easily removed for cleaning.

APPLICATIONS

This category of equipment is ideal when the installation calls for 115 V service or the demand for ultra high efficiency is not present. Do you have a warm or cool spot in your home? Fujitsu mini-splits can provide extra cooling or heating capacity for those hard to cool areas. Commercially, their small size makes them ideal for small offices, providing individual temperature control.



SYSTEMS 9RL2, 12RL2

16.0 SEER		9RL2		12RL2	
Performance					
Nominal Cooling	BTUh	9,000		12,000	
Min.-Max. Cooling	BTUh	1,700~10,700		3,100~12,500	
Nominal Heating	BTUh	10,000		14,000	
Min.-Max. Heating	BTUh	1,700~12,000		3,100~16,000	
SEER		16.0		16.0	
HSPF		9.0		9.0	
EER		10.8		10.0	
Cooling Operating Range	°F (°C)	15~115 (-10~46)		15~115 (-10~46)	
Heating Operating Range	°F (°C)	15~75 (-10~24)		15~75 (-10~24)	
Moisture Removal	Pt./h (l/h)	2.7 (1.3)		3.8 (1.8)	
Fan (Cooling Mode)					
Air Circulation: Hi	CFM (m3/h)	436 (740)		436 (740)	
Medium	CFM (m3/h)	353 (600)		353 (600)	
Low	CFM (m3/h)	265 (450)		265 (450)	
Quiet	CFM (m3/h)	191 (325)		191 (325)	
Fan Speed Stage		4 + Auto		4 + Auto	
Sound					
Indoor Sound Level (Clg/Htg): Hi	dB(A)	43/43		43/43	
Medium	dB(A)	38/38		38/38	
Low	dB(A)	33/33		33/33	
Quiet	dB(A)	23/23		23/23	
Outdoor Sound Level Clg/Htg	dB(A)	47/48		51/51	
Electrical					
Voltage/Frequency/Phase		115/60/1		115/60/1	
Circuit Breaker	Amps	15		20	
Current Rated: Cooling	Amps	7.5		10.9	
Current Rated: Heating	Amps	7.0		11.0	
Power Use Rated: Cooling	kW	0.83		1.20	
Power Use Rated: Heating	kW	0.77		1.21	
Size & Weight					
Net Weight	lbs. (kg)	16 (7)	64 (29)	16 (7)	69 (31)
Dimensions: Height	Inch	10-5/16	21-1/4	10-5/16	21-1/4
	mm	262	540	262	540
Width	Inch	32-9/32	26	32-9/32	26
	mm	820	660	820	660
Depth	Inch	8-1/8	11-11/32	8-1/8	11-11/32
	mm	206	290	206	290
Refrigerant		R410A		R410A	
Additional Data					
Air Direction: Horizontal		Manual		Manual	
Vertical		Automatic		Automatic	
Air Filter		Washable		Washable	
Minimum Lineset Length	Ft (m)	10 (3)		10 (3)	
Maximum Lineset Length	Ft (m)	66 (20) (pre-charge: 49')		66 (20) (pre-charge: 49')	
Max. Vertical Diff.	Ft (m)	49 (15)		49 (15)	
Lineset Diameter	Inch	Gas 3/8	Liq. 1/4	Gas 3/8	Liq. 1/4
		Indoor ASU9RL2	Outdoor AOU9RL2	Indoor ASU12RL2	Outdoor AOU12RL2

Note: Figures are based on 115 Volts.

18, 24, 30, 36,000 BTUh WALL MOUNT HEAT PUMPS

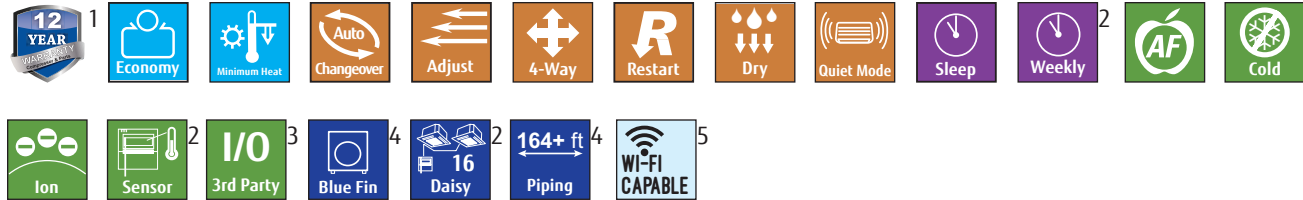

1 Applies when properly registered AND installed by a Fujitsu Elite Contractor in a residence. See full warranty for details.
 2 Available only with optional wired remote control.
 3 Available only with optional Interface kit.
 4 RLXB models only.
 5 See page 13 for details.

FUNCTION

Stylish, slim and elegant, these wall mounted ductless heat pumps are designed for single rooms. Ideal for spaces that require additional capacity but are limited on space. With more efficient zone control, ductless mini-splits are perfect for renovations, restorations, conversions and add-ons.

LOCK OUT FUNCTION

This feature is set by the contractor on behalf of the Commercial Property Owner to prevent either Cooling or Heating operation from occurring. This is not a function that can be set by a tenant, user or home owner.

OPTIONAL ACCESSORIES

Wired Remote Control	UTY-RVNUM
Wired Remote Control	UTY-RNNUM
Simple Remote Control.....	UTY-RSNUM
Dry Contact Wire Kit	UTY-XWZX
Wi-Fi Interface Module	UTY-TFNXZ2



SYSTEMS 18RLB, 24RLB, 30RLXB, 36RLXB

UP TO 19.0 SEER

18RLB



24RLB

30RLXB

36RLXB

Performance		18RLB		24RLB		30RLXB		36RLXB	
Nominal Cooling	BTUh	18,000		24,000		30,000		33,000	
Min.-Max. Cooling	BTUh	3,100~19,000		3,100~25,000		9,900~32,400		9,900~34,100	
Nominal Heating	BTUh	18,000		24,000		30,000		34,000	
Min.-Max. Heating	BTUh	7,000~20,000		7,500~27,000		8,000~33,000		10,200~35,000	
SEER		19.0		18.0		16.5		15.5	
HSPF		10.6		10.6		9.0		9.0	
EER		12.5		10.0		9.5		8.5	
Cooling Operating Range	°F (°C)	14~115 (-10~46)		14~115 (-10~46)		14~115 (-10~46)		14~115 (-10~46)	
Heating Operating Range	°F (°C)	5~75 (-15~24)		5~75 (-15~24)		5~75 (-15~24)		5~75 (-15~24)	
Moisture Removal	Pt./h (l/h)	4.0 (1.9)		6.3 (3.0)		9.7 (4.6)		10.1 (4.8)	
Fan (Cooling Mode)									
Air Circulation: Hi	CFM (m3/h)	542 (920)		659 (1,120) Clg 647 (1,100) Htg		659 (1,120) Clg 677 (1,150) Htg		695 (1,180)	
Medium	CFM (m3/h)	439 (740)		530 (900)		530 (900)		530 (900)	
Low	CFM (m3/h)	365 (620)		436 (740)		436 (740)		436 (740)	
Quiet	CFM (m3/h)	306 (520)		365 (620)		365 (620)		365 (620)	
Fan Speed Stage		4+Auto		4+Auto		4+Auto		4+Auto	
Sound									
Indoor Sound Level (Clg/Htg): Hi	dB(A)	42/43		47/47		47/49		50/50	
Medium	dB(A)	35/36		41/42		42/42		42/42	
Low	dB(A)	31/33		35/36		37/37		37/37	
Quiet	dB(A)	26/28		31/33		32/33		32/33	
Outdoor Sound Level Clg/Htg	dB(A)	51/50		54/55		52/55		52/55	
Electrical									
Voltage/Frequency/Phase		208-230/60/1		208-230/60/1		208-230/60/1		208-230/60/1	
Circuit Breaker	Amps	15		20		30		30	
Current Rated/Max: Cooling	Amps	6.4/8.3		10.5/11.8		13.8/16.8		17.0/18.0	
Current Rated/Max: Heating	Amps	5.8/11.8		8.5/13.8		12.3/18.8		14.8/18.8	
Power Use Rated: Cooling	kW	1.44/1.89		2.40/2.69		3.16/3.83		3.88/4.10	
Power Use Rated: Heating	kW	1.29/2.69		1.93/3.14		2.80/4.28		3.39/4.28	
Size & Weight									
Net Weight	lbs. (kg)	31 (14)	86 (39)	31 (14)	86 (39)	31 (14)	134 (61)	31 (14)	134 (61)
Dimensions: Height	Inch	12-5/8	24-7/16	12-5/8	24-7/16	12-5/8	32-11/16	12-5/8	32-11/16
	mm	320	620	320	620	320	830	320	830
Width	Inch	39-5/16	31-1/8	39-5/16	31-1/8	39-5/16	35-7/16	39-5/16	35-7/16
	mm	998	790	998	790	998	900	998	900
Depth	Inch	9	11-7/16	9	11-7/16	9	13	9	13
	mm	228	290	228	290	228	330	228	330
Refrigerant		R410A		R410A		R410A		R410A	
Additional Data									
Air Direction: Horizontal		Automatic		Automatic		Automatic		Automatic	
Vertical		Automatic		Automatic		Automatic		Automatic	
Air Filter		Washable		Washable		Washable		Washable	
Minimum Piping Length	Ft (m)	10 (3)		10 (3)		16 (5)		16 (5)	
Maximum Piping Length	Ft (m)	66 (20) (pre-charge: 49')		66 (20) (pre-charge: 49')		165 (50) (pre-charge: 66')		165 (50) (pre-charge: 66')	
Maximum Vertical Differential	Ft (m)	49 (15)		49 (15)		98 (30)		98 (30)	
Lineset Size	Inch	Gas 1/2	Liq. 1/4	Gas 1/2	Liq. 1/4	Gas 5/8	Liq. 3/8	Gas 5/8	Liq. 3/8
		Indoor ASU18RLB	Outdoor AOU18RLB	Indoor ASU24RLB	Outdoor AOU24RLB	Indoor ASU30RLXB	Outdoor AOU30RLXB	Indoor ASU36RLXB	Outdoor AOU36RLXB

Note: Figures are based on 230 Volts.

9, 12, 15,000 BTU_h FLOOR MOUNT HEAT PUMPS



1												2
				2	3	2	4					

- 1 Applies when properly registered AND installed by a Fujitsu Elite Contractor in a residence. See full warranty for details.
- 2 Available with optional wired remote control.
- 3 RLFFH models only.
- 4 See page 13 for details.

IDEAL RADIATOR REPLACEMENT



At less than 24" high and 30" wide, floor mount models fit easily under a standard window and can replace a radiator twice its size while producing more capacity.

BASE PAN HEATER (RLFFH MODELS)

RLFF models can operate down to -5°F. RLFFH models can operate down to -15°F. See the full *XLT^H* story on page 14.

OPTIONAL ACCESSORIES

Wired Remote Control	UTY-RVNUM
Wired Remote Controller	UTY-RNNUM
Simple Remote Control.....	UTY-RSNUM
Dry Contact Wire Kit	UTY-XWZXZ5
Wi-Fi Interface Module	UTY-TFNXZ2

TWO FANS AND WIDE AIRFLOW

Having both upper and lower airflow quickly warms or cools the entire room. Floor mount can be set in "Upward Airflow Only" when occupants wish not to have feet warmed or cooled.

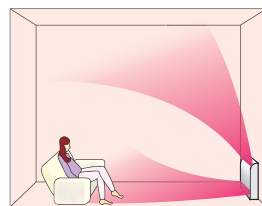

Cooling		<ol style="list-style-type: none"> 1. Upon startup, both top and bottom louvers open. 2. As the room temperature nears the setpoint, only the top louver stays open to help prevent cold air from falling.
Fig. 1	Fig. 2	
Heating		<ol style="list-style-type: none"> 1. Upon startup, both top and bottom louvers open. 2. Closer to setpoint, only the top louver stays open to help prevent cold drafts from windows.
Fig. 1	Fig. 2	

FLEXIBLE AND EASY INSTALLATION

<p>Beneath standard window</p>	<p>Standard concave portion</p>	<p>Low Wall Mount</p>	<p>Half concealed*</p>
--------------------------------	---------------------------------	-----------------------	------------------------

*Field supplied insulation required

SYSTEMS 9RLFF, 12RLFF, 15RLFF HIGH HEAT SYSTEMS 9RLFFH, 12RLFFH, 15RLFFH

UP TO 26 SEER



Performance		9RLFF		12RLFF		15RLFF		9RLFFH		12RLFFH		15RLFFH	
Nominal Cooling	BTUh	9,000		12,000		14,200		9,000		12,000		14,200	
Min.-Max. Cooling	BTUh	3,100~13,000		3,100~14,300		3,100~17,700		3,100~13,000		3,100~14,300		3,100~17,700	
Nominal Heating	BTUh	12,000		16,000		18,000		12,000		16,000		18,000	
Min.-Max. Heating	BTUh	3,100~18,800		3,100~22,100		3,100~23,900		3,100~18,800		3,100~19,500		3,100~20,800	
SEER		26.0		22.7		20.3		26.0		22.7		20.3	
HSPF		12.6		11.6		11.2		12.4		11.3		11.0	
EER		16.0		13.1		12.5		16.0		13.1		12.5	
Cooling Operating Range	°F (°C)	14~115 (-10~46)		14~115 (-10~46)		14~115 (-10~46)		14~115 (-10~46)		14~115 (-10~46)		14~115 (-10~46)	
Heating Operating Range	°F (°C)	-5~75 (-21~24)		-5~75 (-21~24)		-5~75 (-21~24)		-15~75 (-26~24)		-15~75 (-26~24)		-15~75 (-26~24)	
Moisture Removal	Pt./h (l/h)	2.75 (1.3)		3.8 (1.8)		4.44 (2.1)		2.75 (1.3)		3.8 (1.8)		4.44 (2.1)	
Max Htg % of Nominal Capacity at +5°F (-15°C)*		149%		125%		118%		149%		125%		118%	
Max Htg % of Nominal Capacity at -5°F (-21°C)*		130%		111%		107%		130%		111%		107%	
Max Htg % of Nominal Capacity at -15°F (-26°C)*		--		--		--		115%		100%		96%	
Fan (Cooling Mode)													
Air Circulation: Hi	CFM (m3/h)	335 (570)		335 (570)		383 (650)		335 (570)		335 (570)		383 (650)	
Medium	CFM (m3/h)	271 (460)		271 (460)		306 (520)		271 (460)		271 (460)		306 (520)	
Low	CFM (m3/h)	212 (360)		212 (360)		235 (400)		212 (360)		212 (360)		235 (400)	
Quiet	CFM (m3/h)	159 (270)		159 (270)		159 (270)		159 (270)		159 (270)		159 (270)	
Fan Speed Stage		4+Auto		4+Auto		4+Auto		4+Auto		4+Auto		4+Auto	
Sound													
Indoor Level (Clg/Htg): Hi	dB(A)	40/40		40/40		44/43		40/40		40/40		44/43	
Medium	dB(A)	35/35		35/35		38/37		35/35		35/35		38/37	
Low	dB(A)	29/29		29/29		31/29		29/29		29/29		31/29	
Quiet	dB(A)	23/23		23/23		23/23		23/23		23/23		23/23	
Outdoor Level Clg/Htg	dB(A)	50/50		52/52		54/54		50/50		52/52		54/54	
Electrical													
Voltage/Frequency/Phase		208-230/60/1		208-230/60/1		208-230/60/1		208-230/60/1		208-230/60/1		208-230/60/1	
Circuit Breaker	Amps	15		15		20		15		15		20	
Current Rated: Cooling	Amps	2.9		4.2		5.1		2.9		4.2		5.1	
Current Rated: Heating	Amps	4.1		6.7		7.0		4.1		6.7		7.0	
Power Use Rated: Cooling	kW	.56		.97		1.13		.56		.97		1.13	
Power Use Rated: Heating	kW	.88		1.44		1.58		.88		1.44		1.58	
Size & Weight													
Net Weight	lbs. (kg)	31 (14)	84 (38)	31 (14)	84 (38)	31 (14)	86 (39)	31 (14)	86 (39)	31 (14)	86 (39)	31 (14)	88 (40)
Dimensions: Height	Inch	23-5/8	24-7/16	23-5/8	24-7/16	23-5/8	24-7/16	23-5/8	24-7/16	23-5/8	24-7/16	23-5/8	24-7/16
	mm	600	620	600	620	600	620	600	620	600	620	600	620
Width	Inch	29-1/8	31-1/8	29-1/8	31-1/8	29-1/8	31-1/8	29-1/8	31-1/8	29-1/8	31-1/8	29-1/8	31-1/8
	mm	740	790	740	790	740	790	740	790	740	790	740	790
Depth	Inch	7-7/8	11-7/16	7-7/8	11-7/16	7-7/8	11-7/16	7-7/8	11-7/16	7-7/8	11-7/16	7-7/8	11-7/16
	mm	200	290	200	290	200	290	200	290	200	290	200	290
Refrigerant		R410A		R410A		R410A		R410A		R410A		R410A	
Additional Data													
Air Direction: Horizontal		Manual		Manual		Manual		Manual		Manual		Manual	
Vertical		Auto		Auto		Auto		Auto		Auto		Auto	
Air Filter		Washable		Washable		Washable		Washable		Washable		Washable	
Minimum Lineset Length	Ft (m)	10 (3)		10 (3)		10 (3)		10 (3)		10 (3)		10 (3)	
Maximum Lineset Length	Ft (m)	66 (20) (pre-charge: 49')		66 (20) (pre-charge: 49')		66 (20) (pre-charge: 49')		66 (20) (pre-charge: 49')		66 (20) (pre-charge: 49')		66 (20) (pre-charge: 49')	
Max. Vertical Differential	Ft (m)	49 (15)		49 (15)		49 (15)		49 (15)		49 (15)		49 (15)	
Lineset Size	Inch	Gas 3/8	Liq. 1/4	Gas 3/8	Liq. 1/4	Gas 1/2	Liq. 1/4	Gas 3/8	Liq. 1/4	Gas 3/8	Liq. 1/4	Gas 1/2	Liq. 1/4
* Based on model # capacity class (e.g. 9RLS3Y based on 9,000 BTUh) @ 70°F indoor setpoint. Refer to the Design & Technical Manual for more heating capacity data.		Indoor AGU9RLF	Outdoor AOU9RLFF	Indoor AGU12RLF	Outdoor AOU12RLFF	Indoor AGU15RLF	Outdoor AOU15RLFF	Indoor AGU9RLF	Outdoor AOU9RLFFH	Indoor AGU12RLF	Outdoor AOU12RLFFH	Indoor AGU15RLF	Outdoor AOU15RLFFH

Note: Figures are based on 230 Volts.

9, 12, 18,000 BTU/h COMPACT CASSETTE HEAT PUMPS



Compact Cassette Grille UTG-CCGF shown is sold separately and must be ordered with each compact cassette.

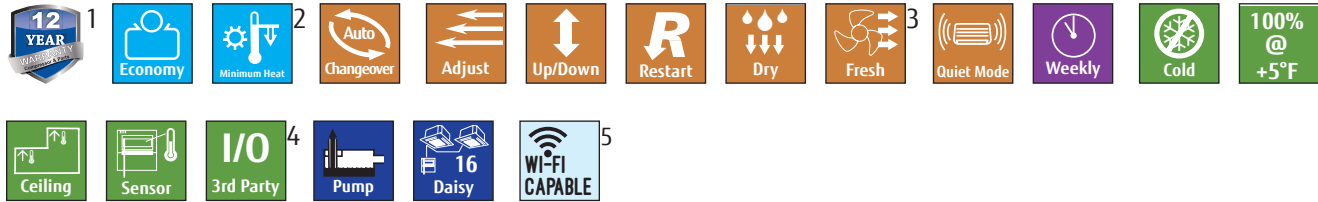

- 1 Applies when properly registered AND installed by a Fujitsu Elite Contractor in a residence. See full warranty for details.
- 2 Available only with optional wireless remote control.
- 3 Requires Fujitsu's Optional Fresh Air Kit part #UTZ-VXAA. Allows for a 4-inch flex duct connection. Requires a field supplied duct booster fan capable of 60 CFM at .2"W.C. or 90 CFM at .4"W.C. For fan static pressure requirements, see installation manual. Add hood, filter and duct losses for fan total static pressure requirements. Will add 4" to the height of the indoor unit.
- 4 Available only with optional Interface kit. Operation monitoring and On/Off control only.
- 5 See page 13 for details.

FUNCTION

The compact and stylish design of the cassette grille fits perfectly into a standard 24" square ceiling grid, with no overlapping of adjacent ceiling tiles. Features include high efficiency up to 24.0 SEER, heating at low temperatures down to -5°F, compact design, quiet operation, a standard wired remote control, and the ability to bring in fresh air through the optional Fresh Air Kit.



FLEXIBLE INSTALLATION

Since this panel fits into the ceiling grid, it can be installed in various locations. For example, you can install it next to recessed ceiling light fixtures.

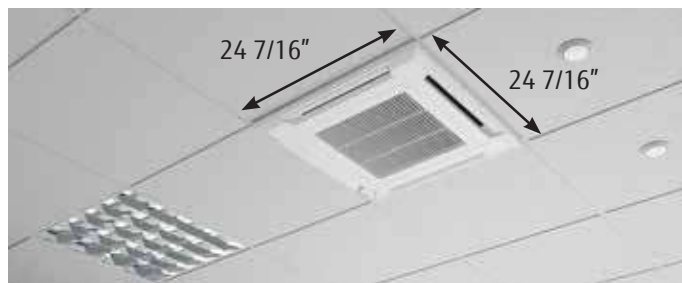

CONSISTENT AIRFLOW DISTRIBUTION

The louver design maintains uniform room temperature by evenly spreading air throughout the space.

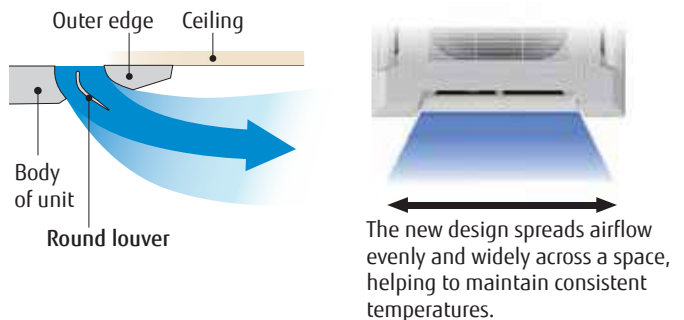

QUIET OPERATION

Unique fan design (laminar wing design) provides whisper-quiet operation with sound pressure levels as low as 27dB(A).





OPTIONAL ACCESSORIES



- Wired Remote Control UTY-RVNUM
- Wireless remote UTY-LNHUM
- Fresh Air Kit..... UTZ-VXAA
- Wi-Fi Interface Module UTY-TFNXZ2

SYSTEMS 9RLFCC, 12RLFCC, 18RLFCC

		9RLFCC			12RLFCC			18RLFCC		
										
UP TO 24.0 SEER										
Performance										
Nominal Cooling	BTUh	9,000			12,000			18,000		
Min.-Max. Cooling	BTUh	3,100~12,000			3,100~13,600			3,100~20,100		
Nominal Heating	BTUh	12,000			16,000			21,600		
Min.-Max. Heating	BTUh	3,100~18,000			3,100~19,400			3,100~25,600		
SEER		24.0			21.9			20.1		
HSPF		13.0			12.2			11.5		
EER		14.5			12.8			11.2		
Cooling Operating Range	°F (°C)	14~115 (-10~46)			14~115 (-10~46)			14~115 (-10~46)		
Heating Operating Range	°F (°C)	-5~75 (-21~24)			-5~75 (-21~24)			-5~75 (-21~24)		
Moisture Removal	Pt./h (l/h)	1.3 (.06)			2.5 (1.2)			4.6 (2.2)		
Fan (Cooling Mode)										
Air Circulation: Hi	CFM (m3/h)	318 (540)			359 (610)			400 (680)		
Medium	CFM (m3/h)	288 (490)			312 (530)			341 (580)		
Low	CFM (m3/h)	259 (440)			277 (470)			288 (490)		
Quiet	CFM (m3/h)	230 (390)			241 (410)			241 (410)		
Fan Speed Stage		4+auto			4+auto			4+auto		
Sound										
Indoor Sound Level (Clg/Htg): Hi	dB(A)	33/34			37/37			40/44		
Medium	dB(A)	32/32			33/33			36/40		
Low	dB(A)	29/29			31/31			32/36		
Quiet	dB(A)	28/27			28/28			28/30		
Outdoor Sound Level Clg/Htg	dB(A)	48/49			49/50			54/55		
Electrical										
Voltage/Frequency/Phase		208-230/60/1			208-230/60/1			208-230/60/1		
Circuit Breaker	Amps	15			15			20		
Current Rated: Cooling	Amps	3.0			4.4			7.1		
Current Rated: Heating	Amps	4.1			6.7			7.7		
Power Use Rated/Max: Cooling	kW	0.62/1.40			0.94/1.45			1.61/2.15		
Power Use Rated/Max: Heating	kW	0.89/1.80			1.44/2.00			1.76/2.60		
Size & Weight										
Net Weight	lbs. (kg)	33 (15)		84 (38)	33 (15)		84 (38)	33 (15)		86 (39)
Dimensions: Height	Inch	9-11/16	1-15/16	24-1/2	9-11/16	1-15/16	24-1/2	9-11/16	1-15/16	24-1/2
	mm	245	49	620	245	49	620	245	49	620
Width	Inch	22-7/16	24-7/16	31-3/32	22-7/16	24-7/16	31-3/32	22-7/16	24-7/16	31-3/32
	mm	570	620	790	570	620	790	570	620	790
Depth	Inch	22-7/16	24-7/16	11-11/32	22-7/16	24-7/16	11-11/32	22-7/16	24-7/16	11-11/32
	mm	570	620	290	570	620	290	570	620	290
Refrigerant		R410A			R410A			R410A		
Additional Data										
Air Direction: Vertical		Automatic			Automatic			Automatic		
Air Filter		Washable			Washable			Washable		
Minimum Lineset Length	Ft (m)	10 (3)			10 (3)			10 (3)		
Maximum Lineset Length	Ft (m)	66 (20)(pre-charge: 49')			66 (20)(pre-charge: 49')			66 (20)(pre-charge: 49')		
Max. Vertical Diff.	Ft (m)	49 (15)			49 (15)			49 (15)		
Lineset Size	Inch	Gas 3/8		Liq. 1/4	Gas 3/8		Liq. 1/4	Gas 1/2		Liq. 1/4
		Indoor AUU9RLF	Grille UTG-CCGFG	Outdoor AOU9RLFC	Indoor AUU12RLF	Grille UTG-CCGFG	Outdoor AOU12RLFC	Indoor AUU18RLF	Grille UTG-CCGFG	Outdoor AOU18RLFC

Note: Figures are based on 230 Volts.

9, 12, 18,000 BTUh SLIM DUCT HEAT PUMPS



12 YEAR WARRANTY

Economy

Minimum Heat

Changeover

Adjust

Restart

Dry

Fresh

Quiet Mode

Weekly

Cold

100% @ +5°F

Sensor

I/O 3rd Party

Pump

16 Daisy

WI-FI CAPABLE

4

- 1 Applies when properly registered AND installed by a Fujitsu Elite Contractor in a residence. See full warranty for details.
- 2 Available only with optional wireless remote control.
- 3 Available only with optional Interface kit. Operation monitoring and On/Off control only.
- 4 See page 13 for details.

FUNCTION

Slim ducts provide cooling or heating for small room applications such as offices, restaurants, convenience stores, motels, dorms, in retrofit and new construction. Long maximum combined piping length of 66' and 49' in height allow for versatile installations. Either horizontal or vertical flexibility and low height enables compact soffit or cabinet installation.

SLIM DUCT

Built-in drain pump allows for installation of slim duct unit in smaller spaces than traditional units.

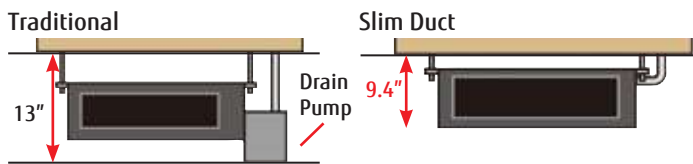

RETURN AIR-INTAKE CHOICES

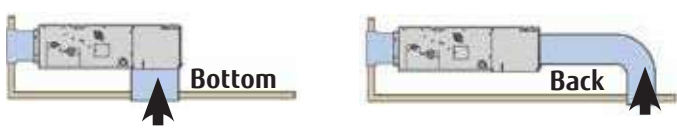

FLEXIBLE INSTALLATION

Unit can be placed horizontally or vertically. However, internal drain pump will not operate when the unit is mounted in a vertical configuration.

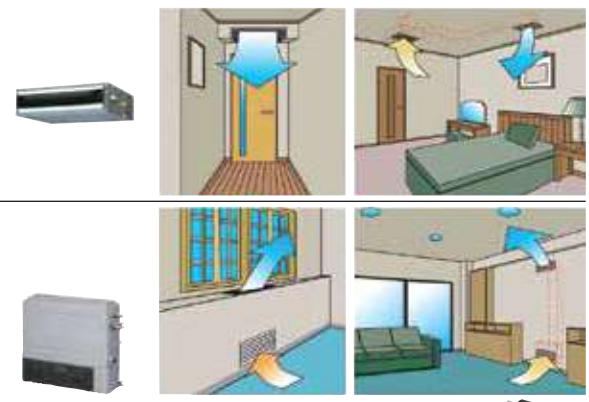

OPTIONAL ACCESSORIES

- Wired Remote Control UTY-RVNUM
- Wireless Remote and Receiver UTY-LRHUM
- Auto Louver Grille Kit (ARU7/9/12) UTD-GX(S/T)A-W
- Auto Louver Grille Kit (ARU18) UTD-GX(S/T)B-W
- Wi-Fi Interface Module UTY-TFNXZZ

FIELD SUPPLIED FILTERS USED WITH SLIM DUCT UNITS

Although Slim Duct units come with factory filters, when return ductwork is used field supplied filters are more practical to use. They can be installed at the unit or for more convenient servicing, in filter grilles. See the guidelines to the right to determine filter sizes.

The chart includes CFM, external static pressure capability and a typical filter size for each model. Filters are sized to keep velocities and static pressure loss low. This will ensure sufficient static pressure is available for ductwork, fittings and supply and return grilles.

Alternative filter sizes with equivalent face areas can be used. After deducting filter loss, available static pressure values are shown.



A sample fiberglass filter is shown in blue to the left. A sample MERV pleated filter is shown in white.

	ARU 9RLF	ARU 12RLF	ARU 18RLF
CFM	353	383	547
Typical Filter Size	12 x 20	12 x 20	14 x 25
Velocity, FPM	212	230	228
Unit External SP, in. W.C.	0.36	0.36	0.36
1" Fiberglass Filter			
*SP Loss, in. W.C.	0.04	0.05	0.04
^Available Static Pressure	0.32	0.31	0.32
1" MERV 8 Pleated Filter			
*SP Loss, in. W.C.	0.12	0.14	0.14
^Available Static Pressure	0.24	0.22	0.22
2" MERV 8 Pleated Filter			
*SP Loss, in. W.C.	0.07	0.08	0.08
^Available Static Pressure	0.29	0.28	0.28

*Typical filter pressure drop.
^Available Static Pressure factors in filter pressure loss only.

SYSTEMS 9RLFC, 12RLFC, 18RLFC

UP TO 21.5 SEER

9RLFC



12RLFC



18RLFC

Performance																			
Nominal Cooling	BTUh	9,000				12,000				18,000									
Min.-Max. Cooling	BTUh	3,100~12,000				3,100~13,600				3,100~20,100									
Nominal Heating	BTUh	12,000				16,000				21,600									
Min.-Max. Heating	BTUh	3,100~18,000				3,100~19,400				3,100~25,600									
SEER		21.5				20.0				19.7									
HSPF		12.2				11.5				11.3									
EER		14.5				12.8				12.0									
Cooling Operating Range	°F (°C)	14~115 (-10~46)				14~115 (-10~46)				14~115 (-10~46)									
Heating Operating Range	°F (°C)	-5~75 (-21~24)				-5~75 (-21~24)				-5~75 (-21~24)									
Moisture Removal	Pt./h (l/h)	1.5 (.07)				2.7 (1.3)				4.2 (2.0)									
Fan (Cooling Mode)																			
Air Circulation: Hi	CFM (m3/h)	353 (600)				383 (650)				554 (940)									
Medium	CFM (m3/h)	324 (550)				353 (600)				518 (880)									
Low	CFM (m3/h)	294 (500)				324 (550)				483 (820)									
Quiet	CFM (m3/h)	265 (450)				283 (480)				442 (750)									
Fan Speed Stage		4+auto				4+auto				4+auto									
Sound																			
Indoor Sound Level (Clg/Htg): Hi	dB(A)	28/28				29/29				32/32									
Medium	dB(A)	27/26				28/28				30/30									
Low	dB(A)	26/25				27/27				29/29									
Quiet	dB(A)	25/24				26/24				27/27									
Outdoor Sound Level Clg/Htg	dB(A)	48/49				49/50				54/55									
Electrical																			
Voltage/Frequency/Phase		208-230/60/1				208-230/60/1				208-230/60/1									
Circuit Breaker	Amps	15				15				20									
Current Rated: Cooling	Amps	3.0				4.4				6.6									
Current Rated: Heating	Amps	3.9				6.0				7.3									
Power Use Rated/Max: Cooling	kW	0.62/1.40				0.94/1.45				1.50/2.15									
Power Use Rated/Max: Heating	kW	0.85/1.80				1.30/2.00				1.67/2.60									
Size & Weight																			
Net Weight	lbs. (kg)	41 (19)			84 (38)			41 (19)			84 (38)			50 (23)			86 (39)		
Dimensions: Height	Inch	7-25/32	5-15/16	6	24-1/2	7-25/32	5-15/16	6	24-1/2	7-25/32	5-15/16	6	24-1/2	7-25/32	5-15/16	6	24-1/2		
	mm	198	151	152	620	198	151	152	620	198	151	152	620	198	151	152	620		
Width	Inch	27-9/16	25-19/32	22	31-3/32	27-9/16	25-19/32	22	31-3/32	35-7/16	33-15/32	30	31-3/32	35-7/16	33-15/32	30	31-3/32		
	mm	700	650	559	790	700	650	559	790	900	850	762	790	900	850	762	790		
Depth	Inch	24-13/32	3/4	3/4 Flat	11-11/32	24-13/32	3/4	3/4 Flat	11-11/32	24-13/32	3/4	3/4 Flat	11-11/32	24-13/32	3/4	3/4 Flat	11-11/32		
	mm	620	19	19 Flat	290	620	19	19 Flat	290	620	19	19 Flat	290	620	19	19 Flat	290		
Refrigerant		R410A				R410A				R410A									
Additional Data																			
Static Pressure in. W. C.		0 ~ 0.36				0 ~ 0.36				0 ~ 0.36									
Air Filter		Washable				Washable				Washable									
Minimum Lineset Length	Ft (m)	10 (3)				10 (3)				10 (3)									
Maximum Lineset Length	Ft (m)	66 (20) (pre-charge: 49')				66 (20) (pre-charge: 49')				66 (20) (pre-charge: 49')									
Max. Vertical Diff.	Ft (m)	49 (15)				49 (15)				49 (15)									
Lineset Size	Inch	Gas 3/8			Liq. 1/4			Gas 3/8			Liq. 1/4			Gas 1/2			Liq. 1/4		
		Indoor ARU9RLF	SUPPLY DUCT FLANGE	RETURN DUCT	Outdoor AO9RLFC	Indoor ARU12RLF	SUPPLY DUCT FLANGE	RETURN DUCT	Outdoor AO12RLFC	Indoor ARU18RLF	SUPPLY DUCT FLANGE	RETURN DUCT	Outdoor AO18RLFC						

Note: Figures are based on 230 Volts.

INFINITE COMFORT SERIES 12, 18, 24, 30, 36, 42, 48,000 BTU_h MEDIUM STATIC DUCTED HEAT PUMPS



ARU12RGLX

ARU18/24/30RGLX

ARU36/42/48RGLX

AOU12RFLC

AOU18/24/30/36RGLX

AOU42/48RGLX

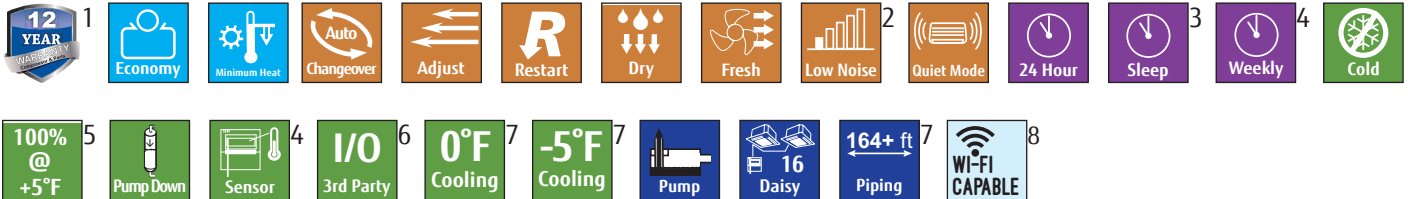

- 1 Applies when properly registered AND installed by a Fujitsu Elite Contractor in a residence. See full warranty for details.
- 2 42, 48,000 BTU_h systems only
- 3 Available only with optional wireless remote control.
- 4 Available only with optional wired remote control.

- 5 12,000 BTU_h system only
- 6 Available only with optional Interface kit. Operation monitoring and On/Off control only.
- 7 18, 24, 30, 36, 42, 48,000 BTU_h systems only.
- 8 See page 13 for details.

FUNCTION

Fujitsu is proud to introduce the newest addition to our single-zone mini-split lineup – three new Medium Static Pressure Duct indoor units! These units use the same energy efficient inverter technology you expect from Fujitsu mini-split products, and they have enough static pressure to heat or cool a whole house. SEER ratings up to 21.3 and a compact size mean these indoor units can find a place in many applications.

ENERGY EFFICIENT & QUIET OPERATION

The combination of the V-shaped heat exchanger, air stabilizer, and the energy efficient DC fan motor results in high efficiency and quiet operation.

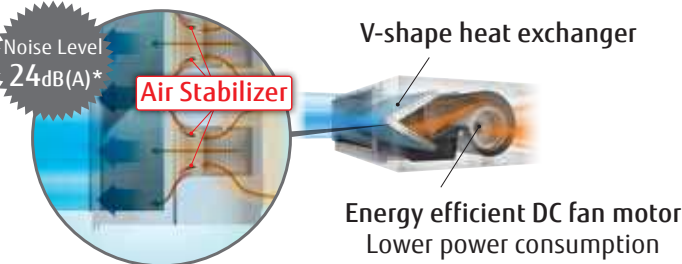
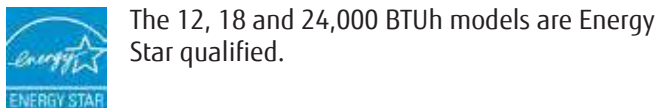

* 12,18, 24,000 BTU_h models fan speed: Quiet

OPTIONAL ACCESSORIES

- Wired Remote Controller UTY-RNRUZ Series
- Simple Remote Controller UTY-RSRY, UTY-RHRY
- Thermostat Converter.....UTY-TTRX
- Wi-Fi Interface Module UTY-TFSXZ2
- External Input and Output PCB..... UTY-XCSX
- Remote Sensor Unit UTY-XSZX

FEATURE HIGHLIGHTS

- Static pressure up to 0.80" W.G. (12/18/24/30/36k models)
- Max piping lengths of up to 246 feet (42/48RGLXD systems)
- Medium Static Ducted units must be installed horizontally
- Heating and cooling operation rated down to -5°F outdoor temperature
- Multiple control options available
- Built-in drain pump
- Automatic static pressure detection for install conditions
- Anti-corrosive coil coating on outdoor unit

Note: Indoor unit will NOT include any wireless or wired controllers in the box. Given that the medium-static RGLX unit is compatible with multiple control options the customer now has the option to choose the controller that best suits their needs.



SYSTEMS 12RGLXD, 18RGLXD, 24RGLXD, 30RGLXD, 36RGLXD, 42RGLXD, 48RGLXD

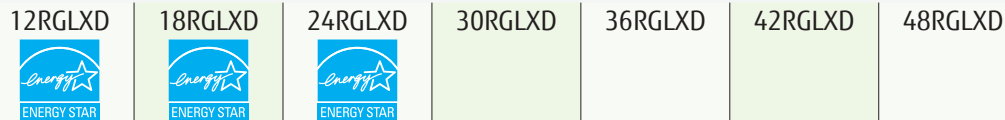

		12RGLXD		18RGLXD		24RGLXD		30RGLXD		36RGLXD		42RGLXD		48RGLXD	
Performance															
Nominal Cooling	BTUh	12,000		18,000		24,000		30,000		36,000		42,000		48,000	
Min.-Max. Cooling	BTUh	3,100-13,600		5,400-21,500		5,400-29,000		9,600-35,000		9,600-39,000		17,100-45,000		17,100-50,000	
Nominal Heating	BTUh	16,000		21,000		27,000		32,000		36,000		47,000		53,000	
Min.-Max. Heating	BTUh	3,100-19,400		5,400-25,600		5,400-32,400		9,200-39,000		9,200-48,000		18,000-51,000		18,000-55,000	
SEER		21.3		19.0		17.5		16.5		16.7		17.8		16.6	
HSPF		11.7		10.9		10.8		10.4		11.3		10.5		10.3	
EER		13.4		13.0		12.6		10.6		10.0		11.5		10.1	
Cooling Operating Range	°F (°C)	14 - 115 (-20 - 46)		-5 - 115 (-20 - 46)		-5 - 115 (-20 - 46)		-5 - 115 (-20 - 46)		-5 - 115 (-20 - 46)		-5 - 115 (-20 - 46)		-5 - 115 (-20 - 46)	
Heating Operating Range	°F (°C)	-5 - 75 (-20 - 24)		-5 - 75 (-20 - 24)		-5 - 75 (-20 - 24)		-5 - 75 (-20 - 24)		-5 - 75 (-20 - 24)		-5 - 75 (-20 - 24)		-5 - 75 (-20 - 24)	
Moisture Removal	Pt./h (l/h)	1.5 (0.7)		3.8 (1.8)		4.0 (1.9)		5.1 (2.4)		5.3 (2.5)		5.5 (2.6)		8.2 (3.9)	
Fan (Cooling Mode)															
Air Circulation (Clg/Htg): Hi	CFM (m3/h)	500 (850)		618 (1050)		800 (1360)		1001 (1700)		1207 (2050) / 1089 (1850)		1501(2550)		1501 (2550)	
Medium	CFM (m3/h)	400 (680)		494 (840)		636 (1080)		800 (1360)		965 (1640)		1201 (2040)		1201 (2040)	
Low	CFM (m3/h)	347 (590)		430 (730)		518 (880)		700 (1190)		783 (1330)		971 (1650)		971 (1650)	
Quiet	CFM (m3/h)	300 (510)		371 (630)		400 (680)		630 (1070)		630 (1070)		842 (1430)		842 (1430)	
Fan Speed Stage		4 + Auto		4 + Auto		4 + Auto		4 + Auto		4 + Auto		4 + Auto		4 + Auto	
Sound															
Indoor Level (Clg/Htg): Hi	dB(A)	35/35		31/31		35/35		38/38		37/35		40/40		40/40	
Medium	dB(A)	30/30		28/28		30/30		34/34		33/33		35/35		35/35	
Low	dB(A)	27/27		25/25		28/28		30/30		30/30		33/33		33/33	
Quiet	dB(A)	24/24		24/24		24/24		29/29		26/26		29/29		29/29	
Outdoor Level Clg/Htg	dB(A)	49/50		47/50		53/55		53/55		54/56		55/57		57/59	
Electrical															
Voltage/Frequency/Phase		208-230/60/1		208-230/60/1		208-230/60/1		208-230/60/1		208-230/60/1		208-230/60/1		208-230/60/1	
Circuit Breaker	Amps	15		20		30		30		30		30		30	
Current Rated: Cooling	Amps	3.9		6.1		8.3		12.4		15.8		16.0		20.9	
Current Rated: Heating	Amps	5.3		6.6		9.0		10.9		12.6		16.1		19.5	
Power Use Rated/Max: Cooling	kW	0.89/1.45		1.38/2.08		1.90/2.82		2.83/3.43		3.60/4.00		3.65/4.47		4.75/5.01	
Power Use Rated/Max: Heating	kW	1.20/1.84		1.50/2.19		2.06/2.96		2.48/3.27		2.88/4.38		3.67/4.57		4.45/4.77	
Size & Weight															
Net Weight	lbs. (kg)	66 (30)	84 (38)	93 (42)	134 (61)	93 (42)	134 (61)	93 (42)	134 (61)	121 (55)	134 (61)	121 (55)	209 (95)	121 (55)	209 (95)
Dimensions: Height	Inch	11-13/16	24-1/2	11-13/16	32-11/16	11-13/16	32-11/16	11-13/16	32-11/16	11-13/16	32-11/16	11-13/16	50-13/16	11-13/16	50-13/16
	mm	300	620	300	830	300	830	300	830	300	830	300	1290	300	1290
Width	Inch	27-9/16	31-3/32	39-3/8	35-7/16	39-3/8	35-7/16	39-3/8	35-7/16	55-1/8	35-7/16	55-1/8	35-7/16	55-1/8	35-7/16
	mm	700	790	1000	900	1000	900	1000	900	1400	900	1400	900	1400	900
Depth	Inch	27-9/16	11-11/32	27-9/16	13	27-9/16	13	27-9/16	13	27-9/16	13	27-9/16	13	27-9/16	13
	mm	700	290	700	330	700	330	700	330	700	330	700	330	700	330
Refrigerant		R410A		R410A		R410A		R410A		R410A		R410A		R410A	
Additional Data															
Static Pressure in. W. C.		0.12 - 0.80		0.12 - 0.80		0.12 - 0.80		0.12 - 0.80		0.12 - 0.80		0.12 - 0.72		0.12 - 0.72	
Min Lineset Length	Ft (m)	16 (5)		16 (5)		16 (5)		16 (5)		16 (5)		16 (5)		16 (5)	
Max Lineset Length	Ft (m)	66 (20) (pre-charge 49')		164 (50) (pre-charge 66')		164 (50) (pre-charge 66')		164 (50) (pre-charge 66')		164 (50) (pre-charge 66')		246 (75) (pre-charge 98')		246 (75) (pre-charge 98')	
Max Vertical Diff.	Ft (m)	49 (15)		98 (30)		98 (30)		98 (30)		98 (30)		98 (30)		98 (30)	
Lineset Size	Inch	Gas 3/8	Liq. 1/4	Gas 1/2	Liq. 1/4	Gas 5/8	Liq. 3/8	Gas 5/8	Liq. 3/8	Gas 5/8	Liq. 3/8	Gas 5/8	Liq. 3/8	Gas 5/8	Liq. 3/8
		Indoor ARU12RGLX	Outdoor AOU12RLFC	Indoor ARU18RGLX	Outdoor AOU18RGLX	Indoor ARU24RGLX	Outdoor AOU24RGLX	Indoor ARU30RGLX	Outdoor AOU30RGLX	Indoor ARU36RGLX	Outdoor AOU36RGLX	Indoor ARU42RGLX	Outdoor AOU42RGLX	Indoor ARU48RGLX	Outdoor AOU48RGLX

INFINITE COMFORT SERIES 24, 30, 36, 48,000 BTUh MULTI-POSITION AIR HANDLER UNITS

Leveraging our cutting edge inverter technology, Fujitsu's Infinite Comfort series combines our revolutionary side discharge outdoor units with a modular design indoor unit. The result: high efficiency, space saving, and quiet single-zone systems with no compromise.

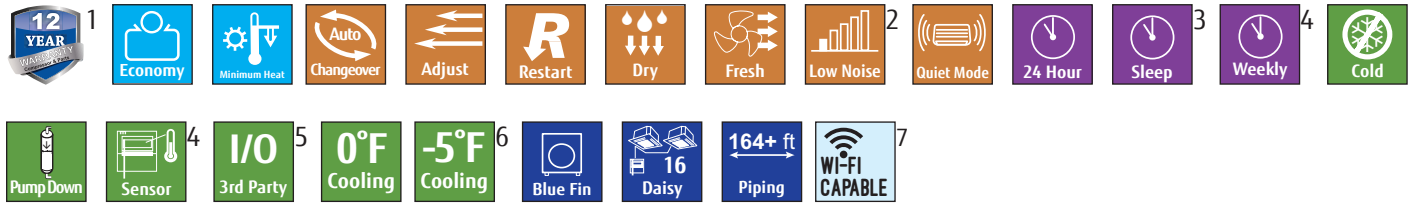

- 1 Applies when properly registered AND installed by a Fujitsu Elite Contractor in a residence. See full warranty for details.
- 2 42, 48,000 BTUh systems only
- 3 Available only with optional wireless remote control.
- 4 Available only with optional wired remote control.

- 5 Available only with optional Interface kit. Operation monitoring and On/Off control only.
- 6 24, 30 BTU/h systems only.
- 7 See page 13 for details.

SYSTEM FEATURES

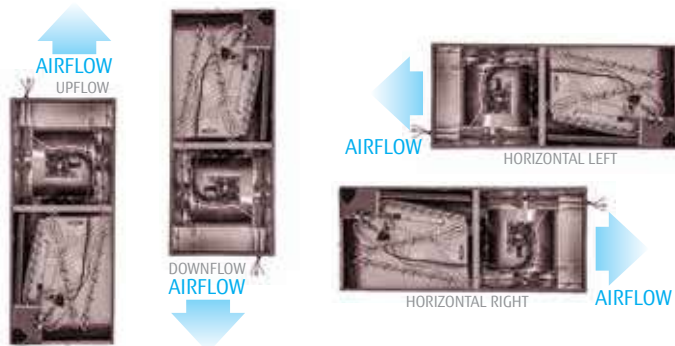

- **True Multi-Position Design** - up flow, down flow, & horizontal
- **High Energy Saving** - Inverter driven heat pump, high efficiency ECM motor, and all-aluminum indoor unit coil.

INDOOR UNIT FEATURES

- All-aluminum indoor unit coil
- High static pressure, up to 1.0 inWG
- Indoor sound levels as low as 24 dBA
- Adaptive fan motor control - Optimum indoor comfort
- Minimal clearance on three sides. Only 24in. clearance on the front for service.
- Downflow and Horizontal Right kits provided with each AHU at no additional cost
- Factory provided and field installed electric heat kit - Up to 15.5kW (Optional)
- External Input/Output Interface - Interlock with 3rd party systems. (Optional)

THE INFINITE COMFORT SERIES IS 4X QUIETER!

You'd need **FOUR** Infinite Comfort Series units to equal the sound level of **ONE** unitary air conditioner.



OUTDOOR UNIT FEATURES

- Fully communicating heat pump with conventional multi-position air handler. Ideal solution for installations with limited space
- Variable speed inverter-driven compressor for optimum system operation and comfort
- Outdoor sound levels as low as 53 dBA
- High efficiency DC motor
- Single fan outdoor unit - Save space without compromise

OPTIONAL ACCESSORIES

Wired Remote Controller	UTY-RNRUZ Series
Simple Remote Controller	UTY-RSRY / UTY-RHRY
Wireless LAN Interface	UTY-TFSXZ2
Thermostat Converter.....	UTY-TTRX
External Input and Output PCB*.....	UTY-XCSX
External Connect Kit.....	UTY-XWZXZG
Wire Kit	UTY-XWZXZJ

* The wireless LAN interface cannot be used at the same time. External Connect Kit (UTY-XWZXZG) is required for the connection

SYSTEMS 24RGLXM, 30RGLXM, 36LMAS1, 48LMAS1

		24RGLXM		30RGLXM		36LMAS1		48LMAS1	
Performance									
Nominal Cooling	BTUh	24000		30000		36000		45600	
Min.-Max. Cooling	BTUh	5,400 - 29,000		9,600 - 35,000		13,000 - 38,000		13,000 - 48,000	
Nominal Heating	BTUh	27000		32000		42000		53000	
Min.-Max. Heating	BTUh	5,400 - 32,400		9,200 - 39,000		11,000 - 52,000		11,000 - 54,000	
SEER		19		18.5		18		17	
HSPF		10.7		10.3		10.2		10.2	
EER		12		10.1		11.3		8.2	
Cooling Operating Range	°F (°C)	-5 - 115 (-20 - 46)		-5 - 115 (-20 - 46)		14 - 115 (-10 - 46)		14 - 115 (-10 - 46)	
Heating Operating Range	°F (°C)	-5 - 75 (-20 - 24)		-5 - 75 (-20 - 24)		-5 - 75 (-20 - 24)		-5 - 75 (-20 - 24)	
Moisture Removal	Pt./h (l/h)	4.6 (2.2)		7.2 (3.4)		7.2 (3.4)		9.3 (4.4)	
Fan (Cooling Mode)									
Air Circulation (Clg/Htg): Hi	CFM (m3/h)	800 (1359)		870 (1478)		1200 (2039)		1640 (2786)	
Medium	CFM (m3/h)	670 (1138)		730 (1240)		740 (1257)		1020 (1733)	
Low	CFM (m3/h)	590 (1002)		590 (1002)		590 (1002)		820 (1393)	
Quiet	CFM (m3/h)	310 (527)		310 (527)		490 (833)		590 (1002)	
Fan Speed Stage		4+Auto		4+Auto		4+Auto		4+Auto	
Sound									
Indoor Level (Clg/Htg): Hi	dB(A)	40/37		42/39		41/40		48/47	
Medium	dB(A)	34/33		37/36		30/35		36/37	
Low	dB(A)	32/31		33/32		27/28		31/32	
Quiet	dB(A)	26/25		28/25		24/26		25/29	
Outdoor Level Clg/Htg	dB(A)	53/55		53/55		53/54		54/55	
Electrical									
Voltage/Frequency/Phase		208-230V/60Hz/1		208-230V/60Hz/1		208-230V/60Hz/1		208-230V/60Hz/1	
Circuit Breaker	Amps	30		30		40		40	
Current Rated: Cooling	Amps	8.8		13		14		24.4/18	
Current Rated: Heating	Amps	10.9		13.26		16.8		23.5	
Power Use Rated/Max: Cooling	kW	2/3.47		2.97/3.41		3.18/3.52		5.56/5.94	
Power Use Rated/Max: Heating	kW	2.48/3.47		3.02/4.16		3.82/5.39		5.35/5.42	
Size & Weight									
Net Weight	lbs. (kg)	104 (47)	134 (61)	104 (47)	134 (61)	132 (60)	198 (90)	132 (60)	198 (90)
Dimensions: Height	Inch	42-8/16	32-11/16	42-8/16	32-11/16	57	39-5/16	57	39-5/16
	mm	1080	830	1080	830	1448	998	1448	998
Width	Inch	21	35-7/16	21	35-7/16	21	38-3/16	21	38-3/16
	mm	533	900	533	900	533	970	533	970
Depth	Inch	21-11/16	13	21-11/16	13	21-11/16	14-9/16	21-11/16	14-9/16
	mm	551	330	551	330	551	370	551	370
Refrigerant		410A		410A		410A		410A	
Additional Data									
Static Pressure in. W. C.		0-1.0 (20-250)		0-1.0 (20-250)		0-1.0 (20-250)		0-1.0 (20-250)	
Min Lineset Length	Ft (m)	16 (5)		16 (5)		16 (5)		16 (5)	
Max Lineset Length	Ft (m)	164 (50) (pre-charge 66')		164 (50) (pre-charge 66')		230 (70) (pre-charge 98')		230 (70) (pre-charge 98')	
Max Vertical Diff.	Ft (m)	98 (30)		98 (30)		98 (30)		98 (30)	
Lineset Size	Inch	3/8	5/8	3/8	5/8	3/8	5/8	3/8	5/8
		AMUG24LMAS	AOU24RGLX	AMUG30LMAS	AOU30RGLX	AMUG36LMAS	AOU36LMAS1	AMUG48LMAS	AOU48LMAS1

18, 24, 36,000 BTUH CEILING & UNIVERSAL HEAT PUMPS

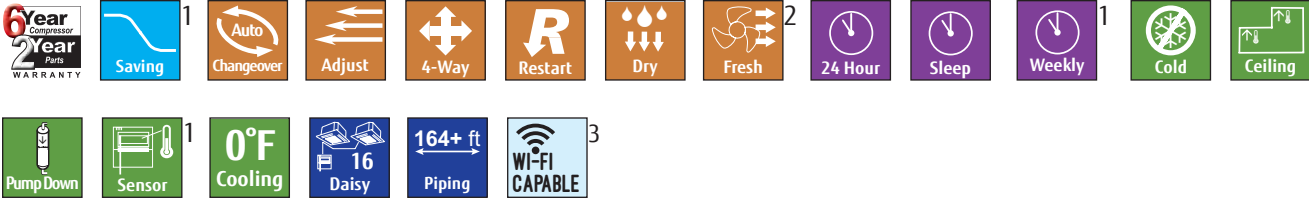

1 Available only with optional wired remote control.
 2 Fresh air knockout available. Fresh air fan and ductwork field supplied. See Design and Technical Manual for details.
 3 See page 13 for details.

APPLICATIONS

The universal floor/ceiling mount 18RULX and 24RULX are ideal for a house of worship to mount beneath stained glass windows. Lower in height than the pews, they do not disturb the aesthetics of the space. With long piping lengths of 165' the outdoor units can also be placed remotely out of sight. Another popular application for this model is in hallways where wall space is limited. The 36RSLX is popular where fresh air intake and high capacity is required like a restaurant or bar. They are also often suspended from threaded rod and used in multiple to condition large warehouse spaces.

FUNCTION

The 18RULX and the 24RULX are universal mount. They can mount low on the wall or transverse mount them on the ceiling. The 36RSLX can only be mounted on the ceiling, can take in fresh air and can throw air farther.

OPTIONAL ACCESSORIES

- Wired Remote Control UTY-RNBYU
Requires dip switch change on indoor unit.
- Condensate Pump UTR-DPB24T
Available only for System 36RSLX.



SYSTEMS 18RULX, 24RULX, 36RSLX

UP TO 16 SEER		18RULX		24RULX		36RSLX	
Performance							
Nominal Cooling	BTUh	17,800		22,200		34,100	
Min.-Max. Cooling	BTUh	5,000~21,600		5,000~27,300		8,500~36,000	
Nominal Heating	BTUh	21,500		24,000		36,500	
Min.-Max. Heating	BTUh	5,000~25,600		5,000~29,000		9,200~42,700	
SEER		16.0		15.0		14.0	
HSPF		8.5		8.5		8.5	
EER		10.9		9.9		8.1	
Cooling Operating Range	°F (°C)	0~115 (-18~46)		0~115 (-18~46)		0~115 (-18~46)	
Heating Operating Range	°F (°C)	14~75 (-10~24)		14~75 (-10~24)		14~75 (-10~24)	
Moisture Removal	Pt./h (l/h)	5.3 (2.5)		7.4 (3.5)		7.4 (3.5)	
Fan (Cooling Mode)							
Air Circulation: Hi	CFM (m3/h)	459 (780)		518 (880)		1089 (1850)	
Medium	CFM (m3/h)	383 (650)		436 (740)		977 (1660)	
Low	CFM (m3/h)	324 (550)		371 (630)		842 (1430)	
Fan Speed Stage		3 + Auto		3 + Auto		3 + Auto	
Sound							
Indoor Sound Level (Clg/Htg): Hi	dB(A)	43/43 (Clg/Htg)		47/47 (Clg/Htg)		48/48 (Clg/Htg)	
Medium	dB(A)	39/39 (Clg/Htg)		43/43 (Clg/Htg)		45/43 (Clg/Htg)	
Low	dB(A)	35/35 (Clg/Htg)		38/38 (Clg/Htg)		41/39 (Clg/Htg)	
Outdoor Sound Level Clg/Htg	dB(A)	51/53		53/55		54/55	
Electrical							
Voltage/Frequency/Phase		208-230/60/1		208-230/60/1		208-230/60/1	
Circuit Breaker	Amps	20		20		30	
Current Rated/Max: Cooling	Amps	7.1/12.5		9.8/12.5		18.3/18.8	
Current Rated/Max: Heating	Amps	9.8/12.5		10.2/12.5		15.3/18.8	
Power Use Rated/Max: Cooling	kW	1.63/2.88		2.25/2.88		4.22/4.35	
Power Use Rated/Max: Heating	kW	2.25/2.88		2.35/2.88		3.50/4.35	
Size & Weight							
Net Weight	lbs. (kg)	62 (28)	141 (64)	62 (28)	141 (64)	106 (48)	141 (64)
Dimensions: Height	Inch	7-7/8	32-3/4	7-7/8	32-3/4	9-1/2	32-3/4
	mm	199	830	199	830	240	830
Width	Inch	39-1/8	35-1/2	39-1/8	35-1/2	65-1/2	35-1/2
	mm	990	900	990	900	1660	900
Depth	Inch	25-7/8	13	25-7/8	13	27-5/8	13
	mm	655	330	655	330	700	330
Refrigerant		R410A		R410A		R410A	
Additional Data							
Air Direction: Horizontal		Automatic		Automatic		Automatic	
Vertical		Automatic		Automatic		Automatic	
Air Filter		Washable		Washable		Washable	
Front Grille		Permanent		Permanent		Permanent	
Minimum Lineset Length	Ft (m)	16 (5)		16 (5)		16 (5)	
Maximum Lineset Length	Ft (m)	165 (50) (pre-charge: 49')		165 (50) (pre-charge: 49')		165 (50) (pre-charge: 49')	
Max. Vertical Diff.	Ft (m)	66 (20)		66 (20)		98 (30)	
Lineset Size	Inch	Gas 1/2	Liq. 1/4	Gas 5/8	Liq. 3/8	Gas 5/8	Liq. 3/8
		Indoor ABU18RULX	Outdoor AOU18RLX	Indoor ABU24RULX	Outdoor AOU24RLX	Indoor ABU36RSLX	Outdoor AOU36RLX

Note: Figures are based on 230 Volts.

18, 24, 30, 36, 42,000 BTUH LARGE CASSETTE CIRCULAR FLOW HEAT PUMPS



AUU18/24RGLX with UTG-LCGVCB



AUU30/36/42/48RGLX with UTG-GCGF



AOU18/24/30/36RGLX



AOU42/48RGLX

1	Economy	ESP	Minimum Heat	Auto Changeover	Adjust	Up/Down	Restart	Dry	Fresh	Low Noise	Quiet Mode	24 Hour	Sleep
Weekly	Cold	Ceiling	Pump Down	Sensor	I/O 3rd Party	0°F Cooling	-5°F Cooling	Branch	Pump	16 Daisy	164+ ft Piping	Slender	WI-FI CAPABLE

- 1 Applies when properly registered AND installed by a Fujitsu Elite Contractor in a residence. See full warranty for details.
- 2 Available only with optional part UTY-SHZXC.
- 3 42, 48,000 BTUH systems only.
- 4 Available only with optional wireless remote control.

- 5 Available only with optional wired remote control.
- 6 Available only with optional Interface kit. Operation monitoring and On/Off control
- 7 See page 13 for details.

BETTER AIR DISTRIBUTION USING 360-DEGREE LOUVERS

Circular flow design allows conditioned air to reach every corner of a room.



INDIVIDUAL LOUVER CONTROL

Each louver can be positioned individually to deliver comfortable air exactly where you want it in any room configuration. To take advantage of this feature use Wired Remote Control (Touch Panel) UTY-RNRUZ Series.



Individual louvers can be programmed separately. Adjust vertical airflow and louver position with UTY-RNRUZ Series Wired Remote Control.

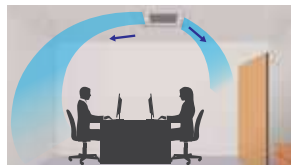

Airflow fan speed can be customized depending on room layout.

QUIET OPERATION AND 4 FAN SPEED CONTROL

With the new airflow structure, sound levels are drastically reduced. Circular flow cassette models operate at whisper quiet sound levels. Choose from 4 different fan speeds.

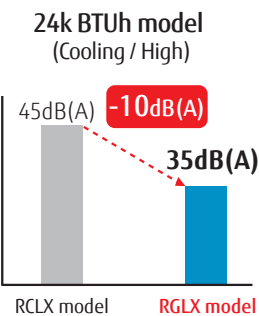

4 fan speeds

- High
- Med
- Low
- Quiet

*Compatible Remote Controller is as follows:
 UTY-RNRUZ2 / UTY-RSRY / UTY-RHRY / UTY-LBTUC

HIGH ENERGY EFFICIENCY

Energy saving performance is achieved through use of a DC twin rotary compressor, DC fan motor and optimized refrigerant cycle control.

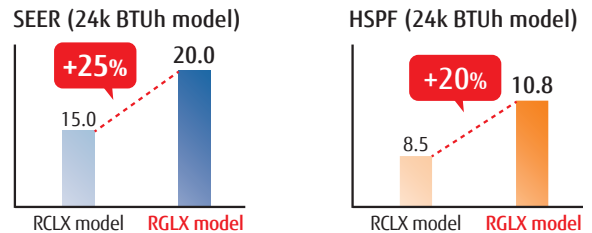

18,000 BTUH and 24,000 BTUH models are Energy Star qualified.

RECOMMENDED ACCESSORIES

NOTE: RGLX Large Cassette grilles are sold separately.

Circular flow cassette grilles come in your choice of either black or white.

UTG-LCGVCB



UTG-GCGF

NOTE: Wired Remote Control sold separately.





RGLX Large Cassettes are compatible with UTY-RNRUZ Series 2-wire controls.

OPTIONAL ACCESSORIES (cont'd on bottom of page 45)

Wired Remote Control (Touch Panel)	UTY-RNRUZ Series
Simple Remote Control.....	UTY-RSRY, UTY-RHRY
Wi-Fi Interface Module.....	UTY-TFSXZ2
External Input and Output PCB.....	UTY-XCSX*
Communication Kit Bracket.....	UTZ-GXRA
IR Receiver Unit.....	UTY-LBTUC
Human Sensor Kit	UTY-SHZXC
Air Outlet Shutter Plate	UTR-YDZK
External Connect Kit.....	UTY-XWZXZG, UTY-XWZXZ3
Wide Panel.....	UTG-AKXA-W
Panel Spacer	UTG-BKXA-W
Fresh Air Intake Kit.....	KHRS940-25
Fresh Air Kit.....	UTZ-VXRA

SYSTEMS 18RGLXC, 24RGLXC, 30RGLXC, 36RGLXC, 42RGLXC, 48RGLXC

		18RGLXC		24RGLXC		30RGLXC		36RGLXC		42RGLXC		48RGLXC	
													
Performance													
Nominal Cooling	BTUh	18,000		24,000		30,000		36,000		42,000		48,000	
Min.-Max. Cooling	BTUh	5,400–21,500		5,400–29,000		9,600–35,000		9,600–39,000		17,100–45,000		17,100–50,000	
Nominal Heating	BTUh	21,000		27,000		32,000		36,000		47,000		53,000	
Min.-Max. Heating	BTUh	5,400–25,600		5,400–32,400		9,200–39,000		9,200–48,000		18,000–51,000		18,000–55,000	
SEER		21.4		20		18.6		17.5		18.5		17.8	
HSPF		10.9		10.8		11.5		11.2		9.7		10.6	
EER	Btu/hW	13.4		12.8		11.7		10		11.3		10.1	
Cooling Operating Range	°F (°C)	-5 - 115 (-20 - 46)		-5 - 115 (-20 - 46)		-5 - 115 (-20 - 46)		-5 - 115 (-20 - 46)		-5 - 115 (-20 - 46)		-5 - 115 (-20 - 46)	
Heating Operating Range	°F (°C)	-5 - 75 (-20 - 24)		-5 - 75 (-20 - 24)		-5 - 75 (-20 - 24)		-5 - 75 (-20 - 24)		-5 - 75 (-20 - 24)		-5 - 75 (-20 - 24)	
Moisture Removal	Pt./h (l/h)	3.9 (2.2)		5.1 (2.9)		5.3 (3.0)		6.5 (3.7)		7.7 (4.4)		9.3 (5.3)	
Fan (Cooling Mode)													
Air Circulation: Hi	CFM (m3/h)	618 (1,050)		677 (1,150)		942 (1,600)		1,118 (1,900)		1,177 (2,000)		1,236 (2,100)	
Medium	CFM (m3/h)	565 (960)		618 (1,050)		824 (1,400)		936 (1,590)		971 (1,650)		1,048 (1,780)	
Low	CFM (m3/h)	530 (900)		577 (980)		748 (1,270)		836 (1,420)		859 (1,460)		942 (1,600)	
Quiet	CFM (m3/h)	459 (780)		512 (870)		677 (1,150)		695 (1,180)		765 (1,300)		777 (1,320)	
Fan Speed Stage		4 + Auto		4 + Auto		4 + Auto		4 + Auto		4 + Auto		4 + Auto	
Sound													
Indoor Sound Level (Clg/Htg): Hi	dB(A)	33/33		35/35		40/40		44/44		46/46		47/47	
Medium	dB(A)	32/32		34/34		38/38		41/41		42/42		43/43	
Low	dB(A)	31/31		32/32		36/36		38/38		39/39		40/40	
Quiet	dB(A)	28/28		29/29		33/33		34/34		35/35		36/36	
Outdoor Sound Level Clg/Htg	dB(A)	47/50		53/55		53/55		54/56		55/57		57/59	
Electrical													
Voltage/Frequency/Phase		208-230/60/1		208-230/60/1		208-230/60/1		208-230/60/1		208-230/60/1		208-230/60/1	
Circuit Breaker	Amps	20		30		30		30		30		30	
Current Rated: Cooling	Amps	6.1		8.4		11.5		16.1		16.7		20.9	
Current Rated: Heating	Amps	6.6		9.6		10.7		12.2		16.8		19.5	
Power Use Rated/Max: Cooling	kW	1.35/2.05		1.88/2.77		2.57/3.33		3.60/3.94		3.72/4.35		4.75/4.91	
Power Use Rated/Max: Heating	kW	1.47/2.27		2.15/2.88		2.38/3.27		2.73/4.19		3.74/4.39		4.49/4.67	
Size & Weight													
Net Weight	lbs. (kg)	53 (24)	134 (61)	53 (24)	134 (61)	57 (26)	134 (61)	57 (26)	134 (61)	64 (29)	209 (95)	64 (29)	209 (95)
Dimensions: Height	Inch	9 11/16	32 11/16	9 11/16	32 11/16	11 5/16	32 11/16	11 5/16	32 11/16	11 5/16	50 13/16	11 5/16	50 13/16
	mm	246	830	246	830	288	830	288	830	288	1290	288	1290
Width	Inch	33 1/16	35 7/16	33 1/16	35 7/16	33 1/16	35 7/16	33 1/16	35 7/16	33 1/16	35 7/16	33 1/16	35 7/16
	mm	840	900	840	900	840	900	840	900	840	900	840	900
Depth	Inch	33 1/16	13	33 1/16	13	33 1/16	13	33 1/16	13	33 1/16	13	33 1/16	13
	mm	840	330	840	330	840	330	840	330	840	330	840	330
Refrigerant		R410A		R410A		R410A		R410A		R410A		R410A	
Additional Data													
		White Grille (UTG-GCGF) or Black Grille (UTG-LCGVCB) Sold Separately											
Minimum Lineset Length	Ft (m)	16 (5)		16 (5)		16 (5)		16 (5)		16 (5)		16 (5)	
Maximum Lineset Length	Ft (m)	164 (50) Precharge 66'		164 (50) Precharge 66'		164 (50) Precharge 66'		164 (50) Precharge 66'		246 (75) Precharge 98'		246 (75) Precharge 98'	
Max. Vertical Diff.	Ft (m)	98 (30)		98 (30)		98 (30)		98 (30)		98 (30)		98 (30)	
Lineset Size	Inch	Gas 1/2	Liq. 1/4	Gas 5/8	Liq. 3/8	Gas 5/8	Liq. 3/8	Gas 5/8	Liq. 3/8	Gas 5/8	Liq. 3/8	Gas 5/8	Liq. 3/8
		Indoor AUU18RGLX	Outdoor AOU18RGLX	Indoor AUU24RGLX	Outdoor AOU24RGLX	Indoor AUU30RGLX	Outdoor AOU30RGLX	Indoor AUU36RGLX	Outdoor AOU36RGLX	Indoor AUU42RGLX	Outdoor AOU42RGLX	Indoor AUU48RGLX	Outdoor AOU48RGLX

Optional Accessories, cont'd: Thermostat Converter - UTY-TTRX - Control your Fujitsu heating and cooling system with your favorite smart thermostat (not included). Wi-Fi Module - UTY-TFNXZ2 - Add wireless capability to your Fujitsu system through FGLair. Cannot be installed in conjunction with Wired Remote Controls. IR Wireless Module - FJ-IR-WIFI-1NA, Wired Module - FJ-RC-WIFI-1NA - The IR Wireless and Wired Modules work with the Intesis AC Cloud Control® app (sold separately).

* The wireless LAN interface cannot be used at the same time. External Connect Kit (UTY-XWZXZG) is required for the connection.

MULTI-ZONE MINI-SPLIT SYSTEMS

- Operate as few as one indoor unit or all indoor units
- Choose from 4 indoor unit styles - wall mount, slim duct, compact cassette, and floor mount
- Many combinations are ENERGY STAR® qualified
- Create hundreds of combinations based on indoor type and BTUh

MULTI-ZONE



- Connect 2 to 5 indoor units, depending on model
- Connect 14,000 to 54,000 BTUh
- No branch boxes or separation tubes required

MULTI-ZONE EXTRA LOW TEMPERATURE HEATING



18, 24, 36,000 BTUh

- Connect 2 to 4 indoor units, depending on model
- Connect 14,000 to 39,000 BTU
- eXtra Low Temp Heating down to -15°F outdoor temps
- No branch boxes or separation tubes required



YEAR-ROUND, WHOLE HOME OR BUSINESS COMFORT

Halcyon Systems are some of today's most advanced forms of heating and air conditioning. Multi-zone outdoor units can operate from 2 to 5 indoor units simultaneously. Fujitsu's systems are super quiet as well as highly energy efficient.

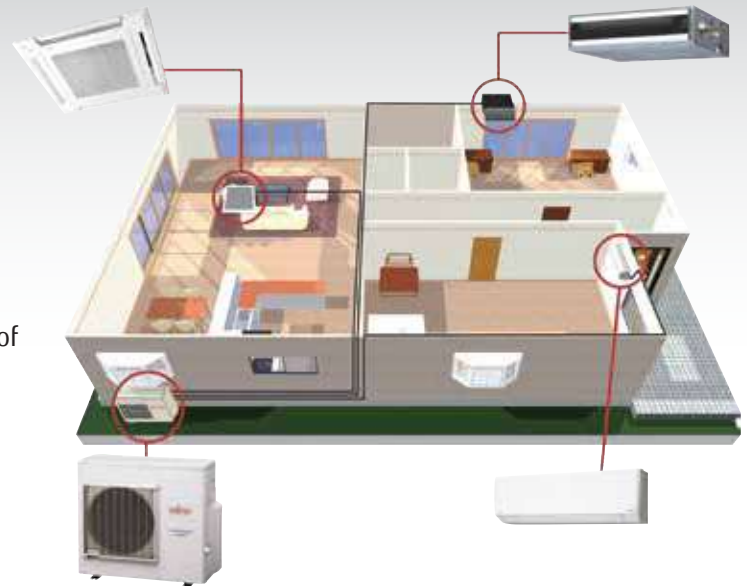

MULTI-ZONE AND XLTH SERIES SYSTEMS 18, 24, 36, AND 45,000 BTUh

AOU18RLXFZ

AOU24RLXFZ

AOU36RLXFZ1

AOU45RLXFZ

AOU18RLXFZH

AOU24RLXFZH

AOU36RLXFZH

CONNECTABLE CAPACITY

This allows connectable indoor units' total capacity to exceed outdoor unit capacity. See Allowable Combination Table on page 64.

If all indoor units are cooling or heating at the same time, the system will limit their capacity so that their total matches the outdoor unit capacity. When a zone meets a desired set temperature it requires less capacity. The unused capacity is then distributed to the remaining indoor units, increasing their capacity.

FOR EXAMPLE

The load on a 3-bedroom home with a living room and kitchen downstairs and 3 bedrooms upstairs is 39,000 BTUh (21,000 BTU downstairs and 18,000 BTU upstairs). However the family isn't upstairs and downstairs at the same time, therefore not all units will be running simultaneously allowing 100% heating or cooling to occupied spaces. This can be achieved by our AOU36RLXFZ1 outdoor unit.



MIX AND MATCH FLEXIBILITY

The ability to create the **right** combinations, the **right** quantity (up to 5-zones), the **right** style indoor units, and the **right** capacity. It's the **RIGHT** choice for your home or business.

MULTI-ZONE INDOOR UNITS

WALL MOUNTS				
ASU7, 9, 12RLF1	✓	✓	✓	✓
ASU15RLF1		✓	✓	✓
ASU18RLF		✓	✓	✓
ASU24RLF			✓	✓
FLOOR MOUNTS				
AGU9, 12RLF	✓	✓	✓	✓
AGU15RLF		✓	✓	✓
SLIM DUCTS				
ARU7, 9, 12RLF	✓	✓	✓	✓
ARU18RLF		✓	✓	✓
ARU24RLF			✓	✓
COMPACT CASSETTES				
AUU7, 9, 12RLF	✓	✓	✓	✓
AUU18RLF		✓	✓	✓
	 AOU18RLXFZ  AOU18RLXFZH 	 AOU24RLXFZ  AOU24RLXFZH 	 AOU36RLXFZ1  AOU36RLXFZH 	 AOU45RLXFZ

MULTI-ZONE OUTDOOR UNITS

INDIVIDUAL ZONING: PERSONALIZED WHOLE HOME COMFORT

WALL MOUNTED

High wall location for minimized presence. The elimination of ducting increases delivered efficiency.

- Quiet operation
- Easy maintenance
- High delivered efficiency means lower utility bills



SLIM DUCT

Mounted in a ceiling or in a framed enclosure below a ceiling. They use minimal ductwork and remain very energy efficient.

- Concealed and out of sight
- Look of central air with the efficiency of a mini-split
- Less ducts = higher efficiency

COMPACT CASSETTE

Cassettes are extremely discreet, with only the grille showing in the ceiling. They use the latest fan technology to distribute the conditioned air evenly.

- Wired remote control (wireless is optional)
- Powerful turbo fan operation
- Fits into a standard 2' x 2' ceiling grid



FLOOR MOUNTED

Floor mount systems are ideal for residential radiator replacements or any room with limited upper wall space, like a kitchen or sunroom.

- Compact size fits easily under a standard window
- Features twin airflow for improved heat delivery
- Designer wireless remote control

7, 9, 12, 15, 18, 24,000 BTU_h WALL MOUNT

MULTI-ZONE INDOOR



ASU7, 9, 12, 15RLF1



ASU18, 24RLF

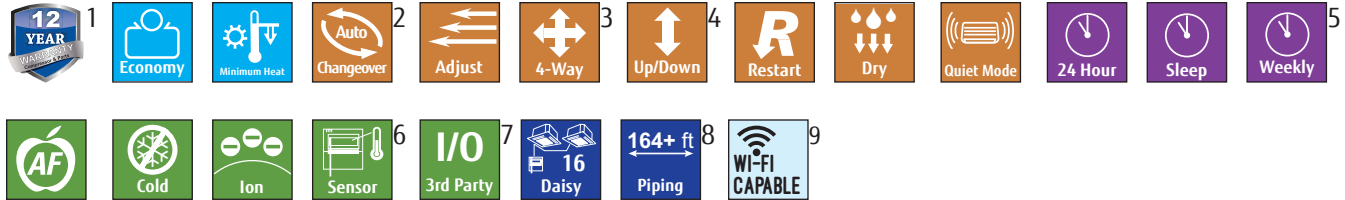

- 1 Applies when properly registered AND installed by a Fujitsu Elite Contractor in a residence. See full warranty for details.
- 2 Auto Changeover is not designed to provide rapid changes between heating and cooling operation or simultaneous heating and cooling. This feature is not recommended for systems with more than one indoor unit unless all indoor units have similar heating and cooling requirements and have similar temperature set points. If all indoor units have similar heating and cooling requirements and have similar temperature set points, auto changeover will work.

- 3 RLF models only.
- 4 RLF1 models only.
- 5 RLF1 models: Available only with optional wired remote control.
- 6 Available only with optional wired remote control and optional interface kit.
- 7 Available only with optional interface kit.
- 8 Available only when used with Flex Zone AOU48RLXFZ1 outdoor unit.
- 9 See page 13 for details.



BUILT IN FILTRATION

LONG-LIFE ION DEODORIZATION FILTER



The filter deodorizes by powerfully decomposing absorbed odors using the oxidizing and reducing effects of ions generated by the ultra-fine-particle ceramic. The filter can be used for approximately 3 years if it is washed with water when dirty to restore its surface action.

APPLE-CATECHIN FILTER



Dust, mold spores and micro-organisms are absorbed onto the filter by static electricity and growth is inhibited and deactivated.

ASU7RLF1, ASU9RLF1, ASU12RLF1, ASU15RLF1, ASU18RLF, ASU24RLF

		ASU7RLF1	ASU9RLF1	ASU12RLF1	ASU15RLF1	ASU18RLF	ASU24RLF
Performance							
Nominal Cooling	BTUh	7,000	9,000	12,000	14,000	18,000	24,000
Nominal Heating	BTUh	8,100	10,200	13,500	16,300	20,000	27,000
Fan (Cooling Mode)							
Air Circulation: Hi	CFM (m3/h)	Clg 330 (560) Htg 330 (560)	Clg 353 (600) Htg 353 (600)	Clg 388 (660) Htg 388 (660)	Clg 430 (730) Htg 430 (730)	Clg 542 (920) Htg 542 (920)	Clg 659 (1,120) Htg 647 (1,100)
Medium	CFM (m3/h)	Clg 294 (500) Htg 294 (500)	Clg 306 (520) Htg 306 (520)	Clg 330 (560) Htg 330 (560)	Clg 353 (600) Htg 362(615)	Clg 436 (740) Htg 436 (740)	Clg 530 (900) Htg 530 (900)
Low	CFM (m3/h)	Clg 253 (430) Htg 253 (430)	Clg 253 (430) Htg 253 (430)	Clg 265 (450) Htg 277 (470)	Clg 312 (530) Htg 330 (560)	Clg 365 (620) Htg 365 (620)	Clg 436 (740) Htg 436 (740)
Quiet	CFM (m3/h)	Clg 182 (310) Htg 194 (330)	Clg 182 (310) Htg 194 (330)	Clg 182 (310) Htg 194 (330)	Clg 212 (360) Htg 221 (375)	Clg 324 (550) Htg 324 (550)	Clg 365 (620) Htg 365 (620)
Fan Speed Stage		4+auto	4+auto	4+auto	4+auto	4+auto	4+auto
Sound							
Indoor Sound Level (Clg/Htg): Hi	dB(A)	36/36	37/37	40/40	42/42	43/44	49/48
Medium	dB(A)	32/32	33/33	36/36	38/38	37/37	42/42
Low	dB(A)	29/29	29/29	30/31	33/35	33/33	37/37
Quiet	dB(A)	21/22	21/22	21/22	25/27	31/31	33/33
Electrical							
Voltage/Frequency/Phase		208-230/60/1	208-230/60/1	208-230/60/1	208-230/60/1	208-230/60/1	208-230/60/1
Current Rated: Cooling	Amps	0.13	0.15	0.19	0.25	0.32	0.53
Current Rated: Heating	Amps	0.13	0.15	0.19	0.25	0.32	0.53
Inut Power	W	15	17	22	28	41	69
Size & Weight							
Net Weight	lbs. (kg)	19 (8.5)	19 (8.5)	19 (8.5)	19 (8.5)	31 (14)	31 (14)
Dimensions: Height	Inch	10-1/2	10-1/2	10-1/2	10-1/2	12-5/8	12-5/8
	mm	268	268	268	268	320	320
Width	Inch	33-1/16	33-1/16	33-1/16	33-1/16	39-1/4	39-1/4
	mm	840	840	840	840	998	998
Depth	Inch	8	8	8	8	9	9
	mm	203	203	203	203	228	228
Refrigerant		R410A	R410A	R410A	R410A	R410A	R410A
Additional Data							
Air Direction: Horizontal		Manual	Manual	Manual	Manual	Auto	Auto
Vertical		Auto	Auto	Auto	Auto	Auto	Auto
Primary Air Filter		Washable	Washable	Washable	Washable	Washable	Washable
Ion Deodorizing Filter		Disposable	Disposable	Disposable	Disposable	Disposable	Disposable
Apple-Catechin Filter		Disposable	Disposable	Disposable	Disposable	Disposable	Disposable
Lineset Size	Inch	Gas 3/8 Liq. 1/4	Gas 3/8 Liq. 1/4	Gas 3/8 Liq. 1/4	Gas 1/2 Liq. 1/4	Gas 1/2 Liq. 1/4	Gas 5/8 Liq. 1/4

7, 9, 12, 18, 24,000 BTUh SLIM DUCT

MULTI-ZONE INDOOR



- 1 Applies when properly registered AND installed by a Fujitsu Elite Contractor in a residence. See full warranty for details.
- 2 Available only with optional wireless remote control.
- 3 Auto Changeover is not designed to provide rapid changes between heating and cooling operation or simultaneous heating and cooling. This feature is not recommended for systems with more than one indoor unit unless all indoor units have similar heating and cooling requirements and have similar temperature set points. If all indoor units have similar heating and cooling requirements and have similar temperature set points, auto changeover will work.
- 4 Available only with optional interface kit.
- 5 Available only when used with Flex Zone AOU48RLXFZ1 outdoor unit.
- 6 See page 13 for details.

FLEXIBLE INSTALLATION

Horizontal or vertical installation. When installed vertically, condensate drain is by gravity only.

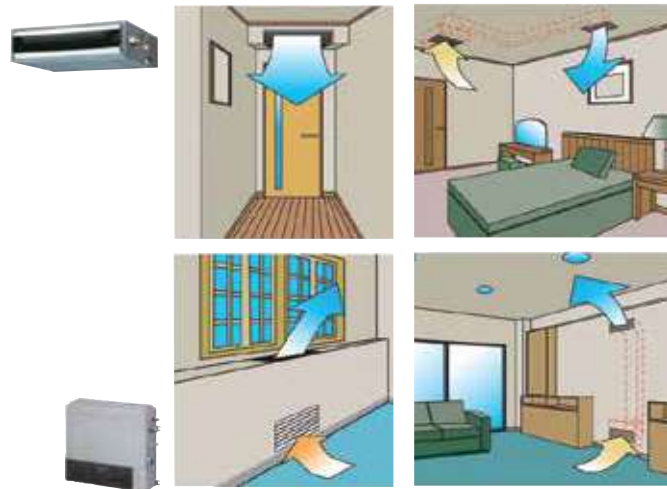

SLIM DUCT

Adaptable when ceiling cavity is small and there is no slope for drain.

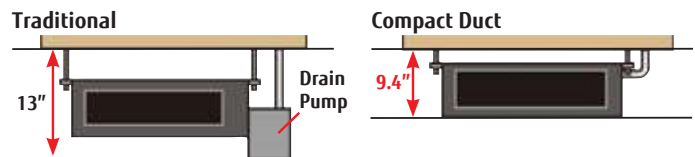

FIELD SUPPLIED FILTERS

Filters are sized to keep velocities and static pressure loss low. This will ensure sufficient static pressure is available for ductwork, fittings and supply and return grilles. Alternative filter sizes with equivalent face areas can be used.

	ARU7RLF	ARU9RLF	ARU12RLF	ARU18RLF	ARU24RLF
CFM	323	353	383	554	785
Typical Filter Size	12 x 20	12 x 20	12 x 20	14 x 25	18 x 30
Velocity, FPM	194	212	230	228	209
Unit External SP, in. W.C.	0.36	0.36	0.36	0.36	0.20
1" Fiberglass Filter					
*SP Loss, in. W.C.	0.04	0.04	0.05	0.04	0.04
^Available Static Pressure	0.32	0.32	0.31	0.32	0.16
1" MERV 8 Pleated Filter					
*SP Loss, in. W.C.	0.10	0.12	0.14	0.14	0.12
^Available Static Pressure	0.26	0.24	0.22	0.22	0.08
2" MERV 8 Pleated Filter					
*SP Loss, in. W.C.	0.06	0.07	0.08	0.08	0.07
^Available Static Pressure	0.30	0.29	0.28	0.28	0.13

*Typical filter pressure drop.
^Available Static Pressure factors in filter pressure loss only.

ARU7RLF, ARU9RLF, ARU12RLF, ARU18RLF, ARU24RLF

		ARU7RLF	ARU9RLF	ARU12RLF	ARU18RLF	ARU24RLF
Performance						
Nominal Cooling	BTUh	7,000	9,000	12,000	18,000	24,000
Nominal Heating	BTUh	8,100	10,200	13,500	20,000	27,000
Fan (Cooling Mode)						
Air Circulation: Hi	CFM (m3/h)	323 (550)	353 (600)	383 (650)	554 (940)	783 (1,330)
Medium	CFM (m3/h)	288 (490)	324 (550)	353 (600)	518 (880)	730 (1,240)
Low	CFM (m3/h)	276 (470)	294 (500)	324 (550)	483 (820)	648 (1,100)
Quiet	CFM (m3/h)	259 (440)	265 (450)	283 (480)	442 (750)	607 (1,030)
Fan Speed Stage		4 + Auto	4 + Auto	4 + Auto	4 + Auto	4 + Auto
Sound						
Indoor Sound Level (Clg/Htg): Hi	dB(A)	28/28	28/28	29/29	32/33	33/35
Medium	dB(A)	26/26	27/26	28/28	31/32	32/34
Low	dB(A)	25/25	26/25	27/27	30/31	30/32
Quiet	dB(A)	24/24	25/24	26/24	29/29	29/29
Electrical						
Voltage/Frequency/Phase		208-230/60/1	208-230/60/1	208-230/60/1	208-230/60/1	208-230/60/1
Static Pressure	W. C.	0 ~ 0.36	0 ~ 0.36	0 ~ 0.36	0 ~ 0.36	0 ~ 0.20
Current Rated: Cooling	Amps	0.30	0.30	0.35	0.44	0.66
Current Rated: Heating	Amps	0.30	0.30	0.35	0.44	0.66
Input Power	W	33	49	58	73	111
Size & Weight						
Net Weight	lbs. (kg)	37 (17)	41 (19)	41 (19)	50 (23)	59 (27)
Dimensions: Height	Inch	7-25/32	7-25/32	7-25/32	7-25/32	7-25/32
	mm	198	198	198	198	198
Width	Inch	27-9/16	27-9/16	27-9/16	35-7/16	43-5/16
	mm	700	700	700	900	1,100
Depth	Inch	24-13/32	24-13/32	24-13/32	24-13/32	24-13/32
	mm	620	620	620	620	620
Supply Duct Flange Dimensions: Height	Inch	5-15/16	5-15/16	5-15/16	5-15/16	5-15/16
	mm	151	151	151	151	151
Width	Inch	25-19/32	25-19/32	25-19/32	33-15/32	41-11/32
	mm	650	650	650	850	1,050
Depth	Inch	3/4	3/4	3/4	3/4	3/4
	mm	19	19	19	19	19
Return Duct Dimensions: Height	Inch	6	6	6	6	6
	mm	152	152	152	152	152
Width	Inch	22	22	22	30	37-3/4
	mm	559	559	559	762	959
Height	Inch	3/4 (Flat)	3/4 (Flat)	3/4 (Flat)	3/4 (Flat)	3/4 (Flat)
	mm	19 (Flat)	19 (Flat)	19 (Flat)	19 (Flat)	19 (Flat)
Refrigerant		R410A	R410A	R410A	R410A	R410A
Additional Data						
Air Filter		Washable	Washable	Washable	Washable	Washable
Lineset Size	Inch	Gas 3/8 Liq. 1/4	Gas 3/8 Liq. 1/4	Gas 3/8 Liq. 1/4	Gas 1/2 Liq. 1/4	Gas 5/8 Liq. 1/4

7, 9, 12, 18,000 BTU_h COMPACT CASSETTES

MULTI-ZONE INDOOR



12
YEAR
WARRANTY

Economy

Minimum Heat

Auto Changeover

Adjust

Up/Down

Restart

Dry

Fresh

Quiet Mode

24 Hour

Sleep

Weekly

Cold

Ceiling

Sensor

I/O 3rd Party

Pump

16 Daisy

164+ ft Piping

WI-FI CAPABLE

- 1 Applies when properly registered AND installed by a Fujitsu Elite Contractor in residence. See full warranty for details.
- 2 Available only with optional wireless remote control.
- 3 Auto Changeover is not designed to provide rapid changes between heating and cooling operation or simultaneous heating and cooling. This feature is not recommended for systems with more than one indoor unit unless all indoor units have similar heating and cooling requirements and have similar temperature set points. If all indoor units have similar heating and cooling requirements and have similar temperature set points, auto changeover will work.
- 4 Requires Fujitsu's Optional Fresh Air Kit part #UTZ-VXAA. Allows for a 4-inch flex duct connection. Requires a field supplied duct booster fan capable of 60 CFM at .2"W.C. or 90 CFM at .4"W.C. For fan static pressure requirements, see installation manual. Add hood, filter and duct losses for fan total static pressure requirements. Will add 4" to the height of the indoor unit.
- 5 Available only with optional Interface kit. Operation monitoring and On/Off control only.
- 6 Available only when used with Flex Zone AOU48RLXFZ1 outdoor unit.
- 7 See page 13 for details.

EASY MAINTENANCE

Maintenance is made simple by removing the ceiling panel next to the grille. Working on the cassette unit from an adjoining ceiling tile keeps disruption and construction costs down.

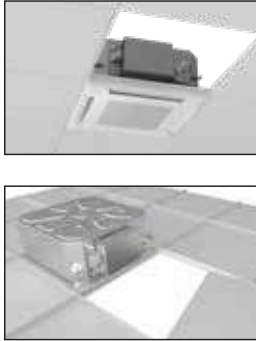

The air inlet grille can be installed in various directions, making maintenance convenient.



2-STAGE TURBO FAN

Air distribution is evenly spread across the heat exchanger by the 2 stage turbo fan which produces two separate airflow streams.

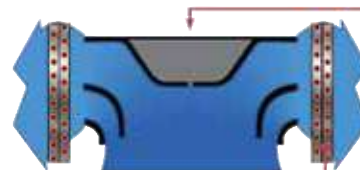

1-stage
+
2-stage

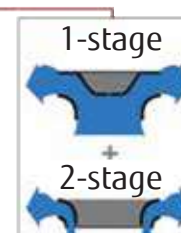

Heat exchange efficiency:
Increased 20%



QUIET OPERATION

Optimization of wing form (laminar wing design) and number of wings (7 blades) enables as low as 27 dB.

Designed by CFD-analysis (fluid) simulations

Laminar wing

Airflow runs through smoothly along the laminar wing



No airflow separation

Quiet

Quiet

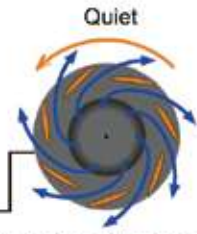

Adoption of laminar wing

Spin direction ←

Airflow direction →

OPTIONAL ACCESSORY



Fresh Air Kit

UTZ-VXAA

Permits limited introduction of outdoor air into the cassette unit for ventilation purposes. Additional items required. (see footnote #4, above)

AUU7RLF, AUU9RLF, AUU12RLF, AUU18RLF

		AUU7RLF	AUU9RLF	AUU12RLF	AUU18RLF
Performance					
Nominal Cooling	BTUh	7,000	9,000	12,000	18,000
Nominal Heating	BTUh	8,100	10,200	13,500	20,000
Fan (Cooling Mode)					
Air Circulation: Hi	CFM (m3/h)	318 (540) Clg or Htg	318 (540) Clg or Htg	359 (610) Clg or Htg	441 (750) Clg 471 (800) Htg
Medium	CFM (m3/h)	288 (490) Clg or Htg	288 (490) Clg or Htg	312 (530) Clg or Htg	359 (610) Clg 418 (710) Htg
Low	CFM (m3/h)	259 (440) Clg or Htg	259 (440) Clg or Htg	277 (470) Clg or Htg	306 (520) Clg 353 (600) Htg
Quiet	CFM (m3/h)	230 (390) Clg or Htg	230 (390) Clg or Htg	241 (410) Clg or Htg	241 (410) Clg 265 (450) Htg
Fan Speed Stage		4+auto	4+auto	4+auto	4+auto
Sound					
Indoor Sound Level (Clg/Htg): Hi	dB(A)	33/34	33/34	37/37	42/44
Medium	dB(A)	31/32	31/32	33/33	37/40
Low	dB(A)	29/29	29/29	31/31	33/37
Quiet	dB(A)	27/27	27/27	28/28	29/30
Electrical					
Voltage/Frequency/Phase		208-230/60/1	208-230/60/1	208-230/60/1	208-230/60/1
Current Rated: Cooling	Amps	0.15	0.15	0.19	0.30
Current Rated: Heating	Amps	0.15	0.15	0.19	0.30
Input Power	W	18	18	23	39
Size & Weight					
Net Weight	lbs. (kg)	33 (15)	33 (15)	33 (15)	33 (15)
Dimensions: Height	Inch	9-11/16	9-11/16	9-11/16	9-11/16
	mm	245	245	245	245
Width	Inch	22-7/16	22-7/16	22-7/16	22-7/16
	mm	570	570	570	570
Depth	Inch	22-7/16	22-7/16	22-7/16	22-7/16
	mm	570	570	570	570
Refrigerant		R410A	R410A	R410A	R410A
Additional Data					
Air Direction: Vertical		Automatic	Automatic	Automatic	Automatic
Air Filter		Washable	Washable	Washable	Washable
Front Grille		UTG-CCGFG*	UTG-CCGFG*	UTG-CCGFG*	UTG-CCGFG*
Grille Dim: Height	Inch (mm)	1-15/16 (49)	1-15/16 (49)	1-15/16 (49)	1-15/16 (49)
Width	Inch (mm)	24-7/16 (620)	24-7/16 (620)	24-7/16 (620)	24-7/16 (620)
Depth	Inch (mm)	24-7/16 (620)	24-7/16 (620)	24-7/16 (620)	24-7/16 (620)
Lineset Size	Inch	Gas 3/8 Liq. 1/4	Gas 3/8 Liq. 1/4	Gas 3/8 Liq. 1/4	Gas 1/2 Liq. 1/4

* Compact Cassette Grille UTG-CCGFG sold separately. Must order one with each compact cassette.

9, 12, 15,000 BTU_h FLOOR MOUNT

MULTI-ZONE INDOOR



- 1 Applies when properly registered AND installed by a Fujitsu Elite Contractor in a residence. See full warranty for details.
- 2 Available with optional wired remote control.
- 3 Available only with optional Interface kit. Operation monitoring and On/Off control only.
- 4 See page 13 for details.

2-FAN AND WIDE AIRFLOW

Having both upper and lower airflow quickly warms or cools the entire room. Floor mount can be set in "Upward Airflow Only" when occupants wish not to have feet warmed or cooled.

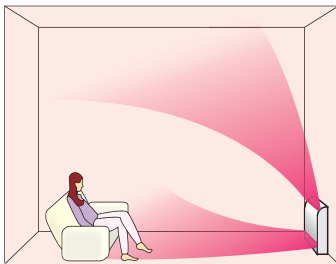

<p>Cooling</p> <p>Fig. 1</p> <p>Fig. 2</p>	<p>Heating</p> <p>Fig. 1</p> <p>Fig. 2</p>
---	---

- | | |
|--|---|
| <ol style="list-style-type: none"> 1. Upon startup, both top and bottom louvers open. 2. As the room temperature nears the setpoint, only the top louver stays open to help prevent cold air from falling. | <ol style="list-style-type: none"> 1. Upon startup, both top and bottom louvers open. 2. Closer to setpoint, only the top louver stays open to help prevent cold drafts from windows. |
|--|---|

FLEXIBLE AND EASY INSTALLATION

<p>Beneath standard window</p>	<p>Standard concave portion</p>
<p>Wall</p>	<p>Half concealed*</p>

*Field supplied insulation required



AGU9RLF, AGU12RLF, AGU15RLF

		AGU9RLF	AGU12RLF	AGU15RLF
Performance				
Nominal Cooling	BTUh	9,000	12,000	14,200
Nominal Heating	BTUh	12,000	16,000	18,000
Fan (Cooling Mode)				
Air Circulation: Hi	CFM (m3/h)	312 (530)	353 (600)	383 (650)
Medium	CFM (m3/h)	259 (440)	288 (490)	306 (520)
Low	CFM (m3/h)	212 (360)	224 (380)	235 (400)
Quiet	CFM (m3/h)	159 (270)	159 (270)	159 (270)
Fan Speed Stage		4+Auto	4+Auto	4+Auto
Sound				
Indoor Sound Level (Clg/Htg): Hi	dB(A)	39/39	42/42	44/44
Medium	dB(A)	34/34	36/38	38/39
Low	dB(A)	28/28	30/32	31/33
Quiet	dB(A)	22/22	22/22	22/22
Electrical				
Voltage/Frequency/Phase		208-230/60/1	208-230/60/1	208-230/60/1
Current Rated: Cooling	Amps	0.15	0.18	0.20
Current Rated: Heating	Amps	0.15	0.18	0.20
Input Power	W	16	18	23
Size & Weight				
Net Weight	lbs. (kg)	31 (14)	31 (14)	31 (14)
Dimensions: Height	Inch	23-5/8	23-5/8	23-5/8
	mm	600	600	600
Width	Inch	29-1/8	29-1/8	29-1/8
	mm	740	740	740
Depth	Inch	7-7/8	7-7/8	7-7/8
	mm	200	200	200
Refrigerant		R410A	R410A	R410A
Additional Data				
Air Direction: Horizontal		Manual	Manual	Manual
Air Direction: Vertical		Auto	Auto	Auto
Apple Catechin Filter		Washable	Washable	Washable
Ion Deodorizing Filter		Yes	Yes	Yes
Connection Method		Yes	Yes	Yes
Lineset Size	Inch	Gas 3/8 Liq. 1/4	Gas 3/8 Liq. 1/4	Gas 1/2 Liq. 1/4



18, 24, 36, 45,000 BTUH MULTI-ZONE OUTDOOR UNITS



Contractors can select either an 18, 24, 36 or 45,000 BTU outdoor unit combined with wall mounted, slim duct, compact cassette or floor mount type indoor units. Mix-and-match flexibility of evaporator type and capacity allows you to choose the indoor unit that best fits the application, whether it be hidden or showcased. These systems are ideal for nursing homes, doctor's offices, condominiums, apartments and residences - any place where individual cooling or heating is needed.

COMPACT SIZE

The compact size of the outdoor units allows for many installation opportunities.

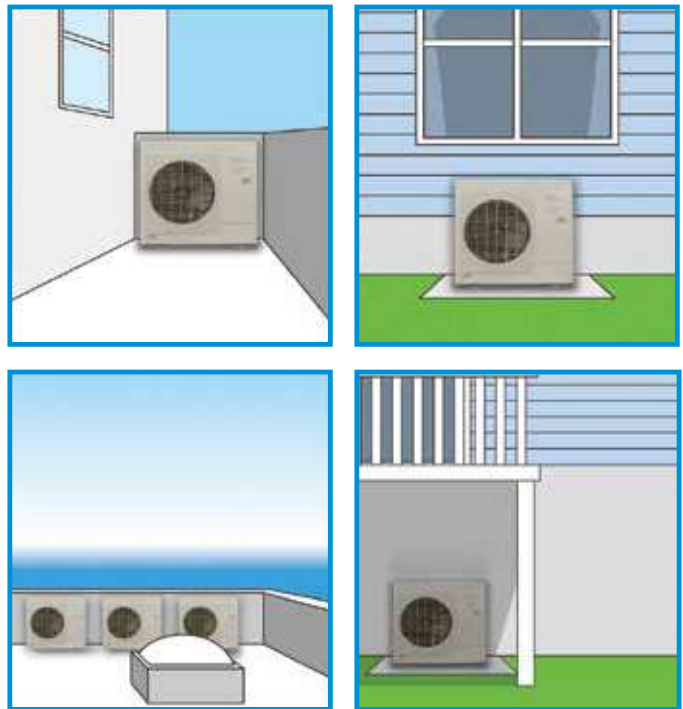

DC TWIN ROTARY COMPRESSOR

A high performance, low noise, large capacity DC twin rotary compressor is used.



SERVICE VALVES

AOU18RLXFZ / AOU24RLXFZ / AOU36RLXFZ1

The above units have (2) service valves for each zone.

BENEFITS:

- **Installation** – Allows for reduced installation time.
- **Service** – Allows for refrigerant isolation of each zone, if necessary.
- **Add Ons** – Ease of additional add-ons.

The AOU45RLXFZ does not have this feature.



ENERGY STAR® QUALIFYING SYSTEMS:

OUTDOOR UNIT	INDOOR UNIT TYPE		
	Non-ducted	Ducted	Mixed
AOU18RLXFZ	★	--	--
AOU24RLXFZ	★	--	--
AOU36RLXFZ1	--	--	--
AOU45RLXFZ	--	--	--

AOU18RLXFZ, AOU24RLXFZ, AOU36RLXFZ1, AOU45RLXFZ

		AOU18RLXFZ ASU9+ASU9	AOU24RLXFZ ASU9+ASU7+ASU7	AOU36RLXFZ1 ASU9 x 4	AOU45RLXFZ ASU9 x 5
Performance					
Connectable Indoor Units		2	2 to 3	2* to 4	2 to 5
Connectable Unit Capacity Class	BTUh	14 to 21,000 ¹	14 to 27,000 ¹	27 to 39,000 ¹	34 to 54,000
Rated Capacity Cooling / Heating		18,000 / 22,000	22,000 / 24,000	35,200 / 36,400	45,000 / 48,000
Cooling Operating Range	°F (°C)	14~115 (-10~46)	14~115 (-10~46)	14~115 (-10~46)	14~115 (-10~46)
Heating Operating Range	°F (°C)	5~75 (-15~24)	5~75 (-15~24)	5~75 (-15~24)	5~75 (-15~24)
Electrical					
Rated Input Power Clg/Htg	kW	1.44/1.87	1.76/1.73	3.52/3.00	4.28/3.88
Voltage/Frequency/Phase		208-230/60/1	208-230/60/1	208-230/60/1	208-230/60/1
Maximum Total Current	Amps	10.0	13.7	20.3	23.8
Minimum Circuit Ampacity	Amps	12.1	16.7	24.6	28.9
Maximum Circuit Breaker	Amps	15	20	30	30
Fan: Type x Quantity		Propeller x 1	Propeller x 1	Propeller x 1	Propeller x 1
Sound Pressure Level Cooling	dB(A)	49	51	53	53
Sound Pressure Level Heating	dB(A)	49	52	55	55
Lineset Requirements					
Minimum Lineset Length Each	ft(m)	16 (5)	16 (5)	16 (5)	16 (5)
Maximum Lineset Length Each	ft(m)	82 (25)	82 (25)	82 (25)	82 (25)
Minimum Lineset Length Total	ft(m)	49 (15)	49 (15)	66 (20)	49 (15)
Maximum Lineset Length Total	ft(m)	164 (50)	164 (50)	230 (70)	264 (80)
Pre-Charge Length Total	ft(m)	98 (30)	98 (30)	164 (50)	164 (50)
Maximum Lineset Height Difference Btwn Outdoor Unit & Furthest Indoor Unit	ft(m)	49 (15)	49 (15)	49 (15)	49 (15)
Maximum Lineset Height Difference Btwn Indoor Units	ft(m)	33 (10)	33 (10)	33 (10)	33 (10)
Lineset Diameter	Inch	Liq. 1/4 x 2 Gas 3/8 x 2	Liq. 1/4 x 3 Gas 1/2 x 1, 3/8 x 2	Liq. 1/4 x 4 Gas 1/2 x 1, 3/8 x 3	Liq. 1/4 x 5 Gas 1/2 x 2, 3/8 x 3
Size & Weight					
Net Weight	lbs. (kg)	119 (54)	124 (56)	149 (68)	205 (93)
Dimensions: Height	Inch	27-9/16	27-9/16	32-11/16	39-5/16
	mm	700	700	830	998
Width	Inch	35-7/16	35-7/16	35-7/16	38-3/16
	mm	900	900	900	970
Depth	Inch	13	13	13	14-9/16
	mm	330	330	330	370
Refrigerant		R410A	R410A	R410A	R410A

*18+18 is the only 2 indoor unit (ASU, ARU or AOU) combination and requires K9FZ1818
¹See table for allowed combinations within this connectable capacity range.



Applies when properly registered AND installed by a Fujitsu Elite Contractor in a residence. See full warranty for details.

18, 24, 36,000 BTU_h XLTH MULTI-ZONE OUTDOOR UNITS



XLTH
18, 24,000 BTU_h



XLTH
36,000 BTU_h

AMBIENT HEATING TEMPERATURE OF -15°F

Other models may go as low as -5°F, however they do not include a base heater and other advancements found in XLTH models. See the full **XLTH** story on page 14.

The base of Fujitsu's XLTH outdoor condensing units.

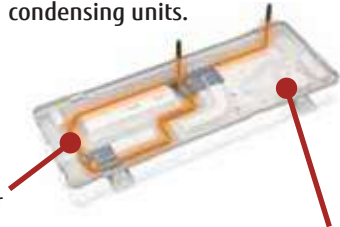

Base Heater

When temperatures reach 36°F, a built-in heater warms the base of the outdoor unit so that condensation doesn't freeze. Without a heater, freezing condensate can cause noise, damage to the fan blade, condenser, and system performance.

Base Drainage Holes

The contoured base design discharges melted water through many holes located at the bottom of the unit.

IMPROVED HEATING CAPACITY

Heating capacity at low outdoor temperatures was improved by adopting a large heat exchanger and a high capacity compressor.

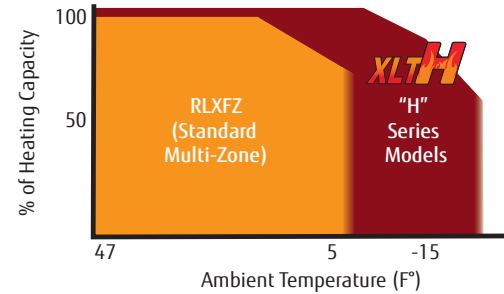

SERVICE VALVES

AOU18RLXFZH / AOU24RLXFZH

The above units have (2) service valves for each zone.

BENEFITS:

- **Installation** – Allows for reduced installation time.
- **Service** – Allows for refrigerant isolation of each zone, if necessary.
- **Add Ons** – Ease of additional add-ons.

The AOU36RLXFZH does not have this feature.



ENERGY STAR® QUALIFYING SYSTEMS:

OUTDOOR UNIT	INDOOR UNIT TYPE		
	Non-ducted	Ducted	Mixed
AOU18RLXFZH	★	--	★
AOU24RLXFZH	★	--	★
AOU36RLXFZH	★	--	★



HIGH-HEAT AOU18RLXFZH, AOU24RLXFZH, AOU36RLXFZH

		AOU18RLXFZH ASU9+ASU9	AOU24RLXFZH ASU9+ASU7+ASU7	AOU36RLXFZH ASU9 x 4
Performance		XLTH	XLTH	XLTH
Connectable Indoor Units		2	2 to 3	2 to 4
Connectable Unit Capacity Class	BTUh	14,000 to 21,000	14,000 to 27,000	27,000 to 39,000
Rated Capacity Cooling/Heating	BTUh	18,000/22,000	22,000/25,000	35,200/36,400
Cooling Operating Range	°F (°C)	14 to 115 (-10 to 46)	14~115 (-10~46)	14~115 (-10~46)
Heating Operating Range	°F (°C)	-15 to 75 (-26 to 24)	-15~75 (-26~24)	-15~75 (-26~24)
Electrical				
Rated Input Power Clg/Htg	kW	1.33/1.70	1.65/1.81	2.70/2.67
Voltage/Frequency/Phase		208-230/60/1	208-230/60/1	208-230/60/1
Maximum Total Current	Amps	16.4	20.8	26.0
Minimum Circuit Ampacity	Amps	19.7	25.1	31.5
Maximum Circuit Breaker	Amps	20	30	40
Fan: Type x Quantity		Propeller x 1	Propeller x 1	Propeller x 1
Sound Pressure Level Cooling	dB(A)	48	50	53
Sound Pressure Level Heating	dB(A)	50	52	55
Lineset Requirements				
Minimum Lineset Length Each	ft(m)	16 (5)	16 (5)	16 (5)
Maximum Lineset Length Each	ft(m)	82 (25)	82 (25)	82 (25)
Minimum Lineset Length Total	ft(m)	49 (15)	49 (15)	49 (15)
Maximum Lineset Length Total	ft(m)	164 (50)	230 (70)	230 (70)
Pre-Charge Length Total	ft(m)	98 (30)	98 (30)	164 (50)
Maximum Lineset Height Difference Btwn Outdoor Unit & Furthest Indoor Unit	ft(m)	49 (15)	49 (15)	49 (15)
Maximum Lineset Height Difference Btwn Indoor Units	ft(m)	33 (10)	33 (10)	33 (10)
Lineset Diameter	Inch	Liq. 1/4 x 2 Gas 3/8 x 2	Liq. 1/4 x 3 Gas 1/2 x 1, 3/8 x 2	Liq. 1/4 x 4 Gas 1/2 x 1, 3/8 x 3
Size & Weight				
Net Weight	lbs. (kg)	134 (61)	146 (66)	205 (93)
Dimensions: Height	Inch	32-11/16	32-11/16	39-5/16
	mm	830	830	998
Width	Inch	35-7/16	35-7/16	38-3/16
	mm	900	900	970
Depth	Inch	13	13	14-9/16
	mm	330	330	370
Refrigerant		R410A	R410A	R410A



Applies when properly registered AND installed by a Fujitsu Elite Contractor in a residence. See full warranty for details.



CASSETTE



AOU45RLXFZ



FLOOR MOUNT



WHOLE HOME SOLUTIONS

18, 24, 36, 45,000 BTUH OUTDOOR HEAT PUMPS

- Connect 2 to 5 indoor units
- 58 to 120% connectable capacity
- Connect 14,000 to 54,000 total BTUh

Cool or heat one room, a few rooms or an entire home.

ALLOWABLE COMBINATIONS

= Allowed "Connectable Capacity" combinations over 100% **



AOU18RLXFZ
XLH
AOU18RLXFZH
Connect 2 indoor units

AOU18RLXFZ / AOU18RLXFZH		
ZONE 1	ZONE 2	TOTAL
7	7	14
7	9	16
7	12	19
9	9	18
9	12	21



AOU24RLXFZ
XLH
AOU24RLXFZH
Connect 2-3 indoor units

AOU24RLXFZ / AOU24RLXFZH			
ZONE 1	ZONE 2	ZONE 3	TOTAL
7	7	+	14
7	9	+	16
7	12	+	19
7	15		22
7	18		25
9	9	+	18
9	12		21
9	15		24
9	18		27
12	12		24
12	15		27
7	7	7	21
7	7	9	23
7	7	12	26
7	9	9	25
9	9	9	27



AOU36RLXFZ1
XLH
AOU36RLXFZH
Connect 2-4 indoor units

AOU36RLXFZH		
ZONE 1	ZONE 2	TOTAL
7	24	31
9	24	33
12	24	36
15	24	39

AOU36RLXFZ1 / AOU36RLXFZH				
ZONE 1	ZONE 2	ZONE 3	ZONE 4	TOTAL
18*	18*			36
7	7	15	+	29
7	7	18	+	32
7	7	24		38
7	9	12	+	28
7	9	15	+	31
7	9	18		34
7	12	12	+	31
7	12	15		34
7	12	18		37
9	9	9	+	27
9	9	12	+	30
9	9	15		33
9	9	18		36
9	12	12		33
9	12	15		36
9	12	18		39
12	12	12		36
12	12	15		39
7	7	7	7	28
7	7	7	9	30
7	7	7	12	33
7	7	7	15	36
7	7	7	18^	39
7	7	9	9	32
7	7	9	12	35
7	7	9	15	38
7	7	12	12	38
7	9	9	9	34
7	9	9	12	37
9	9	9	9	36
9	9	9	12	39

CHOOSE AN OUTDOOR UNIT:

Select either an 18, 24, 36 or 45,000 BTU/h outdoor unit combined with wall mounted, slim duct, compact cassette or floor mount type indoor units. Mix-and-match flexibility of evaporator type and capacity allows you to choose the indoor unit that best fits the application, whether it be hidden or showcased.

CHOOSE INDOOR UNITS:



- ASU7RLF1
- ASU9RLF1
- ASU12RLF1
- ASU15RLF1^o
- ASU18RLF
- ASU24RLF



- ARU7RLF
- ARU9RLF
- ARU12RLF
- ARU18RLF
- ARU24RLF

NOTE: These tables are not for system capacity selection. Fujitsu 'Design Simulator' software can be used for Halcyon equipment selection



- AAU7RLF
- AAU9RLF
- AAU12RLF
- AAU18RLF



- AGU9RLF
- AGU12RLF
- AGU15RLF

^o "+" represents available circuit for future expansion when connecting this combination.
^{*} The optional kit "K9FZ1818 (UTP-MU36A2)" is necessary for dual zone system "18+18" with AOU36RLXFZ1 only.
[^] Wall mounted type ASU18RLF cannot be connected in this combination using AOU36RLXFZ1. Combination allowed with AOU36RLXFZH.
^o Actual rated cooling capacity of ASU15RLF1 is 14,000 BTU/h. Do not use combination table for system capacity calculations.



AOU45RLXFZ

Connect 2-5 indoor units

AOU45RLXFZ			
ZONE 1	ZONE 2	TOTAL	
18	18	36	
12	24	36	
15	24	39	
18	24	42	
24	24	48	
ZONE 1	ZONE 2	ZONE 3	TOTAL
7	7	24	38
7	9	18	34
7	9	24	40
7	12	18	37
7	12	24	43
7	15	15	37
7	15	18	40
7	15	24	46
7	18	18	43
7	18	24	49
9	9	18	36
9	9	24	42
9	12	15	36
9	12	18	39
9	12	24	45
9	15	15	39
9	15	18	42
9	15	24	48
9	18	18	45
9	18	24	51
12	12	12	36
12	12	15	39
12	12	18	42
12	12	24	48
12	15	15	42
12	15	18	45
12	15	24	51
12	18	18	48
12	18	24	54
15	15	15	45
15	15	18	48
15	15	24	54
15	18	18	51
18	18	18	54

AOU45RLXFZ, con't				
ZONE 1	ZONE 2	ZONE 3	ZONE 4	TOTAL
7	7	7	15	36
7	7	7	18	39
7	7	7	24	45
7	7	9	12	35
7	7	9	15	38
7	7	9	18	41
7	7	9	24	47
7	7	12	12	38
7	7	12	15	41
7	7	12	18	44
7	7	12	24	50
7	7	15	15	44
7	7	15	18	47
7	7	15	24	53
7	7	18	18	50
7	9	9	9	34
7	9	9	12	37
7	9	9	15	40
7	9	9	18	43
7	9	9	24	49
7	9	12	12	40
7	9	12	15	43
7	9	12	18	46
7	9	12	24	52
7	9	15	15	46
7	9	15	18	49
7	9	18	18	52
7	12	12	12	43
7	12	12	15	46
7	12	12	18	49
7	12	15	15	49
7	12	15	18	52
7	15	15	15	52
9	9	9	9	36
9	9	9	12	39
9	9	9	15	42
9	9	9	18	45
9	9	9	24	51
9	9	12	12	42
9	9	12	15	45
9	9	12	18	48
9	9	12	24	54
9	9	15	15	48
9	9	15	18	51
9	9	18	18	54
9	12	12	12	45
9	12	12	15	48
9	12	12	18	51
9	12	15	15	51
9	12	15	18	54
12	12	12	12	48
12	12	12	15	51
12	12	12	18	54
12	12	15	15	54

= Allowed "Connectable Capacity" combinations over 100% **

AOU45RLXFZ, con't					
ZONE 1	ZONE 2	ZONE 3	ZONE 4	ZONE 5	TOTAL
7	7	7	7	7	35
7	7	7	7	9	37
7	7	7	7	12	40
7	7	7	7	15	43
7	7	7	7	18	46
7	7	7	7	24	52
7	7	7	9	9	39
7	7	7	9	12	42
7	7	7	9	15	45
7	7	7	9	18	48
7	7	7	9	24	54
7	7	7	12	12	45
7	7	7	12	15	48
7	7	7	12	18	51
7	7	7	15	15	51
7	7	7	15	18	54
7	7	9	9	9	41
7	7	9	9	12	44
7	7	9	9	15	47
7	7	9	9	18	50
7	7	9	9	24	56
7	7	9	12	12	47
7	7	9	12	15	50
7	7	9	12	18	53
7	7	9	15	15	53
7	7	12	12	12	50
7	7	12	12	15	53
7	9	9	9	9	43
7	9	9	9	12	46
7	9	9	9	15	49
7	9	9	9	18	52
7	9	9	12	12	49
7	9	9	12	15	52
7	9	12	12	12	52
9	9	9	9	9	45
9	9	9	9	12	48
9	9	9	9	15	51
9	9	9	9	18	54
9	9	9	12	12	51
9	9	9	12	15	54
9	9	12	12	12	54

NOTE: These tables are not for system capacity selection. Fujitsu 'Design Simulator' software can be used for Halcyon equipment selection

**Exceeding 100% capacity match will not increase system output capacity

ACCESSORY COMPATIBILITY

		SINGLE-ZONE SYSTEMS																												
		WALL MOUNTED															FLOOR MOUNT													
		9RLZ	09LMAST	09LMAHI	09LZAS1	09LZAH1	12RLZ	12LMAST	12LMAHI	12LZAS1	12LZAH1	15LZAS1	15LZAH1	18RLB	18RLXFW1	18RLXFWH	24RLB	24RLXFW1	24RLXFWH	30RLXB	30RLXEH	36RLXB	9RLFF	9RLFFH	12RLFF	12RLFFH	15RLFF	15RLFFH		
REMOTE CONTROLS																														
UTY-RNBYU	Wired Remote Control																													
UTY-RNNUM	Wired Remote Control													●	●	●	●	●	●	●	●	●	●	●	●	●	●	●	●	
UTY-RVNUM	Wired Remote Control (Backlit)													●	●	●	●	●	●	●	●	●	●	●	●	●	●	●	●	
UTY-RSNUM	Simple Remote Control 3-Wire													●	●	●	●	●	●	●	●	●	●	●	●	●	●	●	●	
UTY-RSRY	Simple Remote Control 2-Wire	●2	●2	●2	●2		●2	●2	●2	●2	●2	●2	●2									●								
UTY-RHRY	Simple Remote Control 2-Wire	●2	●2	●2	●2		●2	●2	●2	●2	●2	●2	●2									●								
UTY-LNHUM	Wireless Remote Control																													
UTY-RNRUZ Series	Wired Remote Control	●2	●2	●2	●2		●2	●2	●2	●2	●2	●2	●2									●								
UTY-XSZX	Remote Sensor																													
UTY-LRHUM	Receiver Unit																													
UTY-LBTUM	IR receiver kit w/ wireless remote controller																													
UTY-LBTUC	IR receiver kit w/ wireless remote controller																													
WI-FI DEVICES																														
FJ-IR-WIFI-1NA	Wi-Fi Device: IR Wireless Module	●				●								●	●	●	●	●	●	●	●	●	●	●	●	●	●	●	●	
FJ-RC-WIFI-1NA	Wi-Fi Device: Wired Module													●5	●5	●5	●5	●5	●5	●5	●5	●5	●5	●5	●5	●5	●5	●5	●5	
FJ-AC-WIFI-1	Wi-Fi Device: Wired Module	●	●	●4	●4		●	●	●4	●4	●4	●4										●								
UTY-TFNXZ2	Wi-Fi Interface Module													●	●	●	●	●	●	●	●	●	●	●	●	●	●	●		
UTY-TFSXZ2	Wi-Fi Interface Module																					●								
UTY-TFSXF1	Wi-Fi Interface Module	●	●				●	●																						
INTERFACE KITS																														
UTY-XWZX	Dry Contact Wire Kit													●	●	●	●	●	●	●	●	●	●	●	●	●	●	●		
UTY-XWZXZ5	Dry Contact Wire Kit	●	●	●	●		●	●	●	●	●	●											●	●	●	●	●	●		
UTY-XWZXZG	External Connect Kit																													
UTY-XWZXZJ	External Connect Kit																													
UTY-XCBXZ2	Interface Kit ³																													
UTY-TWRXZ2	Interface Kit ²	●	●	●	●		●	●	●	●	●	●																		
UTD-ECS5A	Slim Duct Connector Kit																													
UTY-XWZXZ3	Outdoor Unit Input/Output Connector																					●								
UTY-XCSXZ1	External input and output PCB																					●								
UTY-XCSXZ2	External input and output PCB	●	●	●4	●4		●	●	●4	●4	●4	●4										●								
UTZ-GXXB	Interface Kit Box																					●								
UTY-XCSX	External input and output PCB																													
UTZ-GXRA	External input and output PCB box																													
UTZ-GXNA	External input and output PCB bracket																													
UTY-SHZXC	Human Sensor Kit																													
FRESH AIR INTAKE KITS																														
UTZ-KXGC	High Humidity Insulation Kit																													
UTR-YDZB	Air Outlet Shutter Plate																													
UTZ-VXAA	Fresh Air Intake Kit																													
UTZ-VXRA	Fresh Air Kit																													
KHRS940-25	Fresh Air Intake																													
UTR-YDZK	Air Outlet Shutter Plate																													
MISCELLANEOUS																														
FJ-AC-BAC-1L	BACnet Gateway	●	●	●4	●4		●	●	●4	●4	●4	●4									●									
FJ-RC-MBS-1	Modbus Module													●5	●5	●5	●5	●5	●5	●5	●5	●	●5	●5	●5	●5	●5	●5		
UTY-VMSX	Modbus Gateway	●	●	●4	●4		●	●	●4	●4	●4	●4																		
UTY-TERX	External Switch Controller	●2	●2	●2	●2		●2	●2	●2	●2	●2	●2		●5	●5	●5	●5	●5	●5	●5	●	●5	●5	●5	●5	●5	●5	●5		
UTY-TTRX	Thermostat Converter	●2	●2	●2	●2		●2	●2	●2	●2	●2	●2		●5	●5	●5	●5	●5	●5	●5	●	●5	●5	●5	●5	●5	●5	●5		
UTY-VTGX	Network Converter	●2	●2	●2	●2		●2	●2	●2	●2	●2	●2		●5	●5	●5	●5	●5	●5	●5	●	●5	●5	●5	●5	●5	●5	●5		
K9R410A55	R410A Swivel Adapter																													
UTD-GXS(A/B/C)-W	Auto Louver Grille Kit ⁷																													
UTD-GXT(A/B/C)-W	Auto Louver Grille Kit ⁷																													

66 1 If using UTY-RNBYU with these models you need to change the dip switch SW-1 to "ON". Refer to Tech Tip #028.
2 Requires accessory interface kit #UTY-TWRXZ2 in order to connect these devices to IDU.

3 Wall mounted ASU7, 9, 12RLF1 and ASU15RLF1 require accessory interface kit #UTY-XCBXZ2 in order to connect these devices to them.

AIRZONE

Compatible with most Halcyon and Airstage, 2-wire and 3-wire single zone systems.

WHAT IS AIRZONE?

Airzone is an intelligent, communicating zoning system for Halcyon and Airstage ducted indoor units, featuring proportional, modulating dampers. Additional ductless and ducted single zone systems may be integrated for total HVAC control.

HOW DOES IT WORK?

All Airzone dampers and optional Zone Modules are connected by a 4-wire cable, for power and communication. Dampers are positioned to provide optimum airflow into a zone based upon demand. The indoor unit fan is adjusted to meet the instantaneous sum of all calling zones.



Airzone VAF Wired Blueface Principal Controller White (AZVAFBLUEFACECB)



Airzone VAF Control Board with Fujitsu UART Communication Region 2 (AZVAFR2FU2)



Airzone VAF 8" Wired Intelligent Round Damper (AZVAFDAMPER08C)



Airzone VAF 8" Wireless Intelligent Round Damper (AZVAFDAMPER08R)

BENEFITS

- An Airzone system can provide precisely delivered airflow into each zone, thus reducing excess equipment capacity.
- Provides ideal temperature control of each zone in your home or office.
- Built in communication gateways maximize Fujitsu Heat Pump inverter efficiency.
- Integrate single zone systems with the ducted, modulating damper system.
- Modulating dampers and proportional fan control eliminates the need for a bypass duct!

FEATURES

- Control and monitor up to 10 individual zones.
- Adjustable minimum and maximum damper positions.
- Control of optional auxiliary heat of the ducted, zoned unit.
- Blueface Principal controller provides simple, single point temperature management of ALL zones!
- Wired and wireless dampers available. Size ranges from 6" to 14" in diameter.
- Flexible control up to 10 hydronic zones, as either primary or auxiliary heat.
- Flexible integration of modulating dampers and single zone units, with optional hydronic heating zones.

CONNECTION DIAGRAM

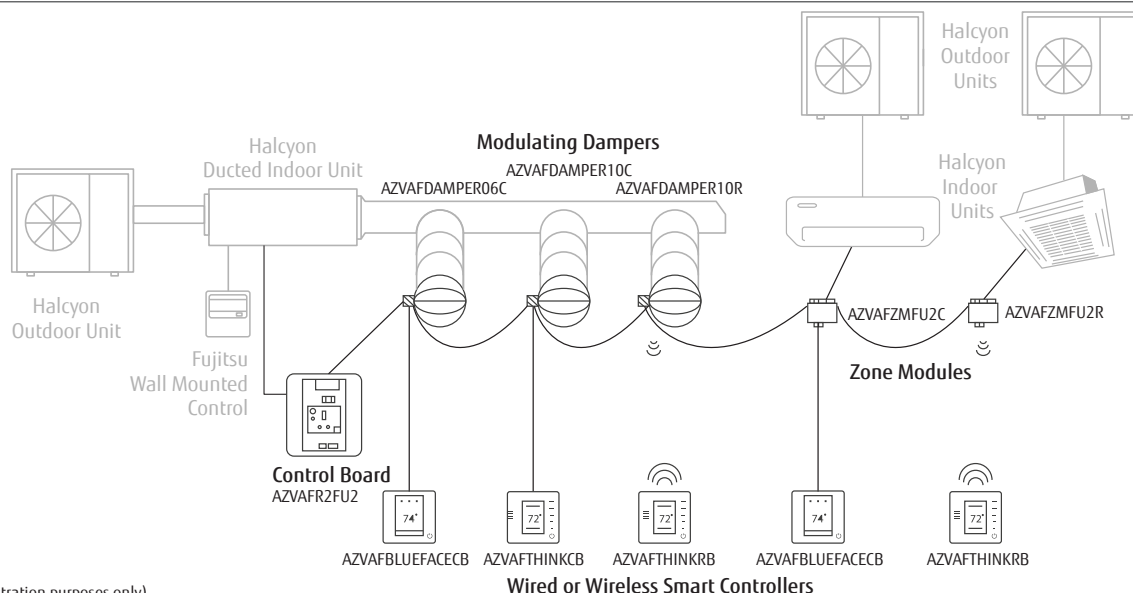

(diagram for illustration purposes only)

CONTROLS

Wired Remote Control

UTY-RNNUM*
UTY-RNBYU^
3-Wire

Group Control



The wired remote control with its unique lock function and sleek design provides full feature access to property managers, building owners, and facility maintenance, as well as providing basic comfort features to tenants, employees, and teachers.

Wired Remote Control

UTY-RVNUM
3-Wire

Group Control



Features a large backlit LCD display and displays the room temperature. Provides full feature access to property managers, building owners, and facility maintenance, as well as providing basic comfort features to tenants, employees, and teachers.

Simple Remote Control

UTY-RSNUM
3-Wire

Group Control



Suitable when only basic operations are required for hotels, offices and other places where there is frequent arrival and departure of occupants. Remote does not allow any timer settings.

Simple Remote Control

2-Wire
UTY-RSRY

Group Control



Backlit 2-wire remote with built in temperature sensor. Offers set point adjustment in 1°F increments. Concentrates on basic functions such as Start/Stop, fan control, temperature setting and operation mode.

Simple Remote Control

2-Wire
UTY-RHRY

Group Control



Backlit 2-wire remote with built in temperature sensor. Offers set point adjustment in 1°F increments. Concentrates on basic functions such as Start/Stop, fan control, and temperature setting.

Wired Remote (Touch Panel)

UTY-RNRUZ Series
2-Wire

Group Control



Features a large backlit LCD display and displays the room temperature. Provides full feature access to property managers, building owners, and facility maintenance, as well as providing basic comfort features to tenants, employees, and teachers.

Wireless Remote Control

UTY-LNHUM

For spaces where there is just no place to mount the wired remote or where wireless operation is preferred.



Central Controller

UTY-DMMUM
3-Wire

This remote controls up to 5 individual indoor units. Set temperatures on timers to best meet individuals needs. Includes a large backlit LCD and 4-way navigation pad. Remote connects in daisy chain to branch boxes.



Remote Sensor

UTY-XSZX

Wall mounted room temperature sensor for slim duct models. Replaces room temperature sensor in the return when installed while still allowing for temperature correction.



Receiver Kit

UTY-LRHUM
3-Wire

For slim duct models. Includes a wireless remote control.



IR Receiver Kit

UTY-LBTUM

For medium static ducted units. Includes a wireless remote control.



IR Receiver Kit

UTY-LBTUC

For large circular flow cassettes. Includes a wireless remote control.



Group Control: With this feature, multiple evaporators can be 'daisy-chained' together on one single remote control. With multiple, single zone systems, Group Control provides the ability of all indoor units to be operated from a single remote control. Group Control may be used on a single, multizone system, however multiple, multizone system indoor units cannot be grouped together. Single and multizone systems cannot be combined for a single Group Control. For additional information, see Engineering Bulletin # 036 and/or 037.

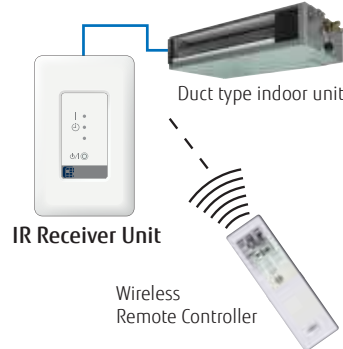
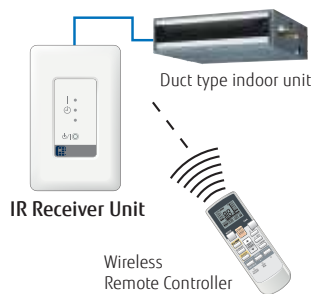

^ Minimum Heat, Sleep Timer functions will be lost when the wired remote control is installed.

* Wall mounted ASU7, 9, and 12RLF1 require accessory interface kit (Part UTY-XCBXZ2) in order to connect this device to them.

WI-FI DEVICES

See compatibility table, page 13.

IR Wireless Module

Model: FJ-IR-WIFI-1NA
Works with Intesis AC Cloud Control® app



Wired Module

Model: FJ-AC-WIFI-1
Works with Intesis AC Cloud Control® app



Wired Module

Model: FJ-RC-WIFI-1NA
Works with Intesis AC Cloud Control® app



SAMPLE WI-FI APP SCREEN DISPLAYS



Intesis AC Cloud Control®



FGLair®

Wi-Fi Module

Model: UTY-TFNXZ2
Works with FGLair® app (Room temp DOES NOT display in FGLair app)



Wi-Fi Module

Model: UTY-TFSXZ2
UTY-TFSXF1
Works with FGLair® app (Room temp DOES display in FGLair app)



ADDITIONAL CONTROLS

Network Converter

UTY-VTGX
The Network Converter is used to control and monitor one or more single-zone Halcyon indoor units (max of 16 IDU's per converter) through Airstage VRF Central Controllers.



Thermostat Converter

UTY-TTRX
Control Halcyon products¹ using a third party thermostat. Up to 16 indoor units can be connected as a group to one thermostat converter.



Modbus Converter

UTY-VMSX
Control and monitor systems over Modbus RTU. ²



BACnet Module

FJ-AC-BAC-1L
Works with Intesis AC Cloud Control® app



Modbus Gateway

FJ-RC-MBS-1
Control and monitor systems over Modbus RTU.



1: NOT compatible with models ABU18/24RULX, ABU36RSLX, AUU18/24/36/42RCLX. 2: Compatible with ARU_RGLX, AUU_RGLX, ASU_LMAS, ASU_LZAS.

INTERFACE KITS

Human Sensor Kit

UTY-SHZXC
For large circular cassette.



Interface Kit

UTY-XCBXZ2
Required to connect ASU7RLF1, 9RLF1, 12RLF1 and 15RLF1 to Wired Remotes UTY-RNNUM and UTY-RVNUM, Dry Contact Wire Kit UTY-XWZX, and Simple Remote Control UTY-RSNUM.



Interface Kit

UTY-TWRXZ2
Required to connect ASU09, 12LMAS, and ASU09, 12, 15LZAS to Wired Remotes UTY-RNRUZ Series, UTY-RSRY, UTY-RHRY, UTY-TTRX Thermostat Converter, and Dry Contact Wire Kit UTY-XWZXZ5.



FRESH AIR INTAKE KITS

High Humidity Insulation Kit

UTZ-KXGC
Compatible with Compact Cassette. Additional insulation which may be needed when cassettes are installed in high humidity areas.



Fresh Air Intake Kit

UTZ-VXAA
Fresh air kit for AUU7-9-12-18RLF units. Mixes room air then passes it through a heat exchanger. Allows for a 4-inch flex duct connection. Requires a field supplied duct booster fan capable of 60 CFM at .2"W.C. or 90 CFM at .4"W.C. For fan static pressure requirements, see installation manual.



Fresh Air Intake Kit

KHRS940-25
Fresh air kit for RULX/RSLX systems. Kit contains Current Sensor with Built-in Relay and Switching Power Supply. Requires field supplied ductwork and a fan capable of generating 15 CFM at a static pressure of approximately 0.26" WC.



Air Outlet Shutter Plate

UTR-YDZK
Compatible with RGLX Large Cassette. Install in a single outlet, to provide a 3-way airflow pattern. Only one supply air outlet can be blocked at a time.



Air Outlet Shutter Plate

UTR-YDZB
Compatible with Compact Cassette. In a 3-way air flow configuration an Air Outlet Shutter Plate kit is required to block air flow of 1 louver.









Fresh Air Kit

UTZ-VXRA
For AUU18-24-30-36-42-48RGLX units. Mixes room air then passes it through a heat exchanger. Allows for a 4-inch flex duct connection. Allows up to 10% if high airflow volume.

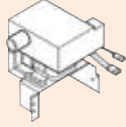

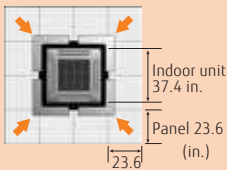
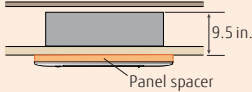
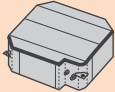
MISCELLANEOUS

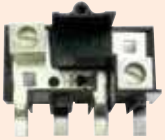
<p>3-Pole Single Throw Safety Switch K3PST</p> <p>For use where code requires a disconnect at the indoor unit. Not compatible with AOU45RLXFZ.</p> 	<p>R410A Swivel Adapter K9R410A55</p> <p>In order to minimize incorrect charging of systems with R410A Fujitsu uses a different access port. Contractors will need this 55-degree swivel access fitting. not compatible with AOU45RLXFZ.</p> 	<p>Plug Model UTY-WIFI</p> <p>In order to connect certain models to Wired Wi-Fi Module, FJ-RC-WIFI-1NA, this plug must be used.</p> 
<p>Condensate Pump UTR-DPB24T</p> <p>OEM design plugs into factory harness for ease of installation. Rated for 11.8" of vertical lift. Only used with System 36RSLX.</p> 	<p>18+18 Combo Fittings Kit K9FZ1818</p> <p>Allows two ASU18RLF1 indoor units to be used on an outdoor AOU36RLXFZ1. Requires special piping; limited to only 18,000 BTU models. Total BTU capacity is limited to 31,600 BTU in cooling. The kit upsizes linesets to 3/8" and 1/2".</p> 	<p>Auto Louver Grille Kit UTD-GX(S/T)A-W (for ARU7/9/12) UTD-GX(S/T)B-W (for ARU18) UTD-GX(S/T)C-W (for ARU24)</p> <p>Auto Louver provides comfortable airflow and blends in with various interiors. Grille can be connected either directly to indoor unit or through the rectangular duct. Only compatible with ARU models with serial numbers greater than 2000.</p> 
<p>Wide Panel UTG-AKXA-W</p> <p>Hides the gap between the ceiling hole and the cassette grille.</p> 	<p>Panel Spacer UTG-BKXA-W</p> <p>If there is not enough height in the ceiling space, by inserting this spacer between the cassette grille and the ceiling surface, the height of the body goes into the ceiling space becomes 2 in. (50mm) lower.</p> 	<p>High Humidity Insulation Kit UTZ-KXRA</p> <p>Compatible with RGLX Large Cassette. Install when the under-roof humidity is over 80% and the temperature is over 86° F (30° C)</p> 
<p>Wind Baffles</p> <p>Ensure continued operation during high wind conditions, especially with roof-mounted units. Wind Baffles prevent nuisance stoppage of outdoor unit, if wind gusts reverse fan rotation while the fan motor is off. Reference Wind Baffle chart below.</p> 	<p>Electric Heater Kit RXBH-1724***-A Series</p> <p>Compatible with AMUG24, 30, 36, 48LMAS Reference multi-position AHU documentation for compatibility.</p> 	<p>Electric Heater Jumper Bar RXBJ-A21*</p> <p>Required for electric heater kit 13kW and above.</p> 

WIND BAFFLE COMPATIBLE UNITS

HALCYON MODEL	WIND BAFFLE MODEL	HALCYON MODEL	WIND BAFFLE MODEL	
AOU9RL2	UTZ-DUWBCA	AOU18RLXF1	UTZ-DUWBVWA	
AOU12RL2		AOU24RLXF1		
AOUG09LMAS1	UTZ-DUWBG2A	AOU18RLXFWH		
AOUG12LMAS1		AOU24RLXFWH		
AOUG09LMAH1^		AOU30RLXB		
AOUG12LMAH1^		AOU36RLXB		
AOUG09LZAS1	UTZ-DUWBG3A	AOU18RLX		
AOUG12LZAS1		AOU24RLX		
AOUG15LZAS1		AOU36RLX		
AOUG09LZAH1		AOU18RLXFZH		
AOUG12LZAH1		AOU24RLXFZH		
AOUG15LZAH1		AOU36RLXFZ1		
AOU45RLXFZ	UTZ-DUWBUA	AOU18RGLX		
AOU36RLXFZH		AOU24RGLX		
AOUG36LMAS1		AOU30RGLX		
AOUG48LMAS1		AOU36RGLX		
AOU30RLXEH	UTZ-DUWBYA*	AOU18RLXFZ		UTZ-DUWBVWA
AOU42RGLX		AOU24RLXFZ		
AOU48RGLX				

NOTE: Wind baffles do not extend low ambient cooling capacities. Please refer to Application Buletin AH20201101A for best practices regarding wind baffle usage.

*Please note that these ship with 2 wind baffle units.
^Coming Q3 2021.

LINESET SIZES AND LENGTHS - SINGLE ZONE

	SINGLE-ZONE SYSTEMS																										
	WALL MOUNTED																		FLOOR MOUNT								
	9RLZ	09LMAST	09LMAH1	09LZAS1	09LZAH1	12RLZ	12LMAST	12LMAH1	12LZAS1	12LZAH1	15LZAS1	15LZAH1	18RLB	18RLXFW1	18RLXFWH	24RLB	24RLXFW1	24RLXFWH	30RLXB	30RLXEH	36RLXB	9RLFF	9RLFFH	12RLFF	12RLFFH	15RLFF	15RLFFH
1/4" x 3/8"	•	•	•	•	•	•	•	•	•													•	•	•	•		
1/4" x 1/2"										•	•	•				•										•	•
3/8" x 5/8"														•	•		•	•	•	•	•						
Total System																											
Max. Combined Pipe Length ft (m)	66 (20)	66 (20)	66 (20)	66 (20)	66 (20)	66 (20)	66 (20)	66 (20)	66 (20)	66 (20)	66 (20)	66 (20)	165 (50)	165 (50)	66 (20)	165 (50)	165 (50)	165 (50)	246 (75)	165 (50)	66 (20)	66 (20)	66 (20)	66 (20)	66 (20)	66 (20)	
Max. Pre-charge Lineset length ft (m)	49 (15)	49 (15)	49 (15)	49 (15)	49 (15)	49 (15)	49 (15)	49 (15)	49 (15)	49 (15)	49 (15)	49 (15)	66 (20)	66 (20)	49 (15)	66 (20)	66 (20)	66 (20)	66 (20)	66 (20)	49 (15)	49 (15)	49 (15)	49 (15)	49 (15)	49 (15)	
Min. Lineset Length ft (m)	10 (3)	16 (5)	16 (5)	16 (5)	16 (5)	10 (3)	16 (5)	16 (5)	16 (5)	16 (5)	16 (5)	10 (3)	16 (5)	16 (5)	10 (3)	16 (5)	16 (5)	16 (5)	16 (5)	16 (5)	10 (3)	10 (3)	10 (3)	10 (3)	10 (3)	10 (3)	

■ While these systems share indoor units, different line sizes are required.

	SINGLE-ZONE SYSTEMS																										
	COMPACT CASSETTE			SLIM DUCT			MEDIUM STATIC DUCTED						MULTI-POSITION AIR HANDLER				UNIVERSAL FLOOR / CEILING			CIRCULAR FLOW LARGE CASSETTE							
	9RLFCC	12RLFCC	18RLFCC	9RLFCD	12RLFCD	18RLFCD	12RGLXD	18RGLXD	24RGLXD	30RGLXD	36RGLXD	42RGLXD	48RGLXD	24RGLXM	30RGLXM	36LMAST	48LMAST	18RULX	24RULX	36RSLX	18RGLXC	24RGLXC	30RGLXC	36RGLXC	42RGLXC	48RGLXC	
1/4" x 3/8"	•	•		•	•		•																				
1/4" x 1/2"			•			•		•										•			•						
3/8" x 5/8"									•	•	•	•	•	•	•	•			•	•	•	•	•	•	•	•	
Total System																											
Max. Combined Pipe Length ft (m)	66 (20)	66 (20)	66 (20)	66 (20)	66 (20)	66 (20)	66 (20)	164 (50)	164 (50)	164 (50)	164 (50)	246 (75)	246 (75)	164 (50)	164 (50)	230 (70)	230 (70)	165 (50)	165 (50)	165 (50)	164 (50)	164 (50)	164 (50)	164 (50)	164 (50)	164 (50)	
Max. Pre-charge Lineset length ft (m)	49 (15)	49 (15)	49 (15)	49 (15)	49 (15)	49 (15)	49 (15)	66 (20)	66 (20)	66 (20)	66 (20)	98 (30)	98 (30)	66 (20)	66 (20)	98 (30)	98 (30)	49 (15)	49 (15)	49 (15)	66 (20)	66 (20)	66 (20)	66 (20)	98 (30)	98 (30)	
Min. Lineset Length ft (m)	10 (3)	10 (3)	10 (3)	10 (3)	10 (3)	10 (3)	16 (5)	16 (5)	16 (5)	16 (5)	16 (5)	16 (5)	16 (5)	16 (5)	16 (5)	16 (5)	16 (5)	16 (5)	16 (5)	16 (5)	16 (5)	16 (5)	16 (5)	16 (5)	16 (5)	16 (5)	



LINE SET SIZES AND LENGTHS - MULTI-ZONE

	MULTI / FLEX ZONE MODELS - INDOOR UNITS																						
	WALL MOUNTED						FLOOR MOUNT			SLIM DUCT				COMPACT CASSETTE				MIXED					
	ASU7RLF1	ASU9RLF1	ASU12RLF1	ASU15RLF1	ASU18RLF	ASU24RLF	AGU9RLF	AGU12RLF	AGU15RLF	ARU7RLF	ARU9RLF	ARU12RLF	ARU18RLF	ARU24RLF	AUU7RLF	AUU9RLF	AUU12RLF	AUU18RLF	ASU18RLF x 2*	ARU18RLF x 2*	AUU18RLF x 2*		
1/4" x 3/8"	•	•	•				•	•		•	•	•			•			•	•	•			
1/4" x 1/2"				•	•				•				•							•			
1/4" x 5/8"						•								•									
3/8" x 1/2"																		•	•	•			
Each Indoor Unit	Minimum and maximum pipe lengths for multi-zone units are found on page 59 and page 61.																						

MULTI / FLEX ZONE MODELS - OUTDOOR UNITS

	AOU18RLXFZ	AOU18RLXFZH	AOU24RLXFZ	AOU24RLXFZH	AOU36RLXFZ1	AOU36RLXFZH	AOU45RLXFZ
Total System							
Max. Combined Pipe Length ft (m)	165 (50)	165 (50)	165 (50)	165 (50)	230 (70)	230 (70)	264 (80)
Max. lineset length (Pre-charge) ft (m)	98 (30)	98 (30)	98 (30)	98 (30)	164 (50)	164 (50)	164 (50)
Min. Lineset Length ft (m)	49 (15)	49 (15)	49 (15)	49 (15)	66 (20)	49 (15)	49 (15)

* 18+18 is the only 2 indoor unit combination allowed for AOU36RLXFZ1 and requires kit K9FZ1818.

■ While these systems share indoor units, different line sizes are required.



FUJITSU MODEL NOMENCLATURE

Legacy models

	AOU	18	R	L	X	F	Z	H	1	
AOU = Outdoor(Single/Multi)										Model Version. May not be combined. Outdoor: H = XLTH Z = Zone W = Wall Mount Only C = Cassette D = Ducted F = HFI (when followed by a "W" or "Z") or Floor Mount W = Wall Mount Only C = Compact Cassette or Slim Duct B = 230V E = Engineering Series A = R410A X = Extended Line Set L = Inverter S = Super Efficient B = 230V
ASU = Wall Mount										
ABU = Ceiling/Universal Mount										
ARU = Ducted										
AUU = Cassette										
AGU = Floor Mount										
BTUh in thousands										
R = Reverse Cycle Heat Pump										
L = Inverter										
S = Ceiling Susp.										
U = Universal										
G = Large Cassette / Medium Static										

"Next Generation" models

	A	O	U	G	12	L	Z	A	S	1	
A = Heat pump for N. America											1-Single-zone Outdoor: S = Standard H = XLTH Indoor: S=Standard Series(Version) A-Z Z = High Tier M = Standard L = R410A/Inverter/Cooling and Heating(H/P)
O = Outdoor(Single/Multi)											
S = Wall Mount											
M = Multi-Position Air Handler											
U = FUJITSU/60Hz/208-230V/N. America											
System Generation											
A-Z											
BTUh in thousands											



THINGS TO KNOW BEFORE YOU BUY A FUJITSU SYSTEM

COMPLETE SYSTEM WARRANTY

Standard warranties vary depending on model:



6 Year Compressor / 2 Year Parts warranty OR



7 Year Compressor / 5 Year Parts warranty.

Extended warranties include:



10 Year Compressor/Parts warranty for Halcyon systems that have been installed by a licensed contractor and the online Product Registration* has been submitted.



12 Year Compressor/Parts warranty for Halcyon systems that have been installed by an Elite Contractor and the online Product Registration* has been submitted.

Systems must be registered within 60 days of installation for extended warranty.

10-Year and 12-Year warranties exclude: R22 models, IAQ models, ASU30RLX, ABU18RULX, ABU24RULX, ABU36RSLX, AUU18RLCX, AUU24RCLX, AUU36RCLX, AUU42RCLX, AOU18RLX, AOU24RLX, AOU30RLX, AOU36RLX, AOU42RLX

* Residents of California and Quebec are not required to register the System in order to obtain all of the rights and remedies applicable to this Warranty.

For full details, see Halcyon Warranty Statement.

TRADEMARKS

The Fujitsu logo is a registered trademark of Fujitsu Limited.



is a worldwide trademark of FUJITSU GENERAL LIMITED and is a registered trademark of Japan, the USA, and other countries or areas.



is a worldwide trademark of FUJITSU GENERAL LIMITED.

ENERGY STAR® is a registered trademark of the EPA and DOE.

Copyright © 2021 Fujitsu General America, Inc.

NON-INTERNET RETAIL POLICY

Internet sales are strictly prohibited and unauthorized. Any HVAC systems purchased on the Internet, from an online retailer or any similar e-tailing website, OR where the original factory serial numbers have been removed, defaced, or replaced in any way WILL NOT BE COVERED BY WARRANTY.

NOTE

- Condensing units come pre-charged from factory. Additional refrigerant may be required, be sure to check installation manual for more details.
- Cooling capacity is based on the following conditions:
Indoor temperature: 80°F DB/67°F WB (26.7°C DB/19.4°C WB)
Outdoor temperature: 95°F DB/75°F WB (35°C DB/23.9°C WB)
- Heating capacity is based on the following conditions:
Indoor temperature: 70°F DB (21.1°C DB)
Outdoor temperature: 47°F DB/43°F WB (8.3°C DB/6.1°C WB)

THINGS TO KNOW BEFORE YOU INSTALL A FUJITSU SYSTEM

WARNING

Always use a licensed installer or contractor to install this product. Do not try to install the product yourself. Improper installation can result in water or refrigerant leakage, electrical shock, fire or explosion. Use only parts and accessories supplied or specified by Fujitsu. Ask a licensed contractor to install parts and accessories. Use of unauthorized or improper installation of parts and accessories can result in injury or property damage. Read the owner's operation manual carefully before using this product. The owners operation manual provides important safety instructions and warnings which should be followed closely. For any questions or concerns, please contact Fujitsu General America, Inc. Proper sizing and installation of equipment is critical to achieve optimal performance. Split system air conditioners and heat pumps must be matched with appropriate coil components to meet ENERGY STAR criteria. Ask your contractor for details or visit www.energystar.gov.

HEAT PUMP DISCLAIMER

In most climates a heat pump will handle all of your heating needs. However, this system sometimes requires some other additional source of heat to satisfy heating requirements in the coldest environments. Almost all of Fujitsu's heat pumps use inverter technology and as such offer a wider operating range and more heat capacity than a standard heat pump but will not provide adequate heating if improperly sized or operated outside of its operating range. Specifications vary by model; please consult your contractor before choosing a heat pump as your only source of heat.

Systems will maintain temperature up to +/-4 degrees relative to set temperature. To increase energy efficiency on multi-type systems, you should turn off the evaporators when heating or cooling is not needed.

DISCLAIMER

Fujitsu's products are subject to continuous improvements. Fujitsu reserves the right to modify product design, specifications and information in this brochure without notice and without incurring any obligations.

CERTIFICATIONS

ISO

ISO14001 is the standard defined by the International Organization for Standardization (ISO) related to environmental management systems. Fujitsu General America, Inc. has been acknowledged by an internationally accredited compliance organization as having an appropriate program of environmental protection procedures and activities to meet the requirements of ISO14001. The air conditioners manufactured by Fujitsu have received ISO9001 series certification for quality assurance.



Intertek

- ISO9001
- ISO14001

ASTM

Our outdoor units shall withstand 1,000 hours of salt spray tested per procedure ASTM B117.

RoHS COMPLIANT

Fujitsu participates in the RoHS Directive, which is the Restriction of Hazardous Substances in electrical and electronic equipment. It is an EU directive intended to protect the environment by forcing manufacturers to eliminate or severely curtail the use of cadmium, hexavalent chromium, and lead in all products from automobiles to consumer electronics.



AHRI ENERGY GUIDE® PROGRAM (U.S.)

To view AHRI numbers or Energy Guide labels, please go to www.ahrirectory.org.



HRAI ENERGY GUIDE® PROGRAM (CANADA)

Samples:

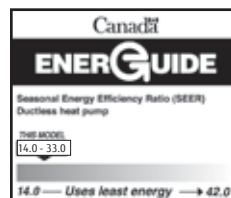

For over 40 years,
making the hottest places cool and the coolest places...
more comfortable.

Halcyon Mini-Splits Are For You If:

- If you want to reduce your utility bills by up to 30%
- Central air quotes give you sticker shock
- Want to reclaim attic and closet space occupied by ductwork
- You have warm or cold spots in your home or business
- Your window air conditioner's noise prevents you from hearing the television

Halcyon 



The Fujitsu logo is a registered trademark of Fujitsu Limited. The Halcyon logo and name is a trademark of Fujitsu General America, Inc. Copyright 2021 Fujitsu General America, Inc.

Distributed by:

FUJITSU

INFINITE COMFORT

FUJITSU GENERAL AMERICA, INC.
340 Changebridge Rd
Pine Brook, NJ 07058
Toll Free: (888) 888-3424
Local: (973) 575-0380
Email: hvac@fujitsugeneral.com
www.fujitsugeneral.com

