



STEEL WOOD STOVES

QUADRA-FIRE
NOTHING BURNS LIKE A QUAD

QUADRA-FIRE®

PERFORMANCE FROM THE BEGINNING



In 1990, the U.S. Environmental Protection Agency (EPA) enacted stringent wood-burning regulations, crippling the more than 500 wood stove manufacturers around the country. But not Quadra-Fire®.

Two years of research and development later, founders Alan Trusler and Dan Henry unveiled their patented “Quad Burn” system. The technology produced powerful and efficient rolling flames so intense, it dawned the inception of the Quadra-Fire name.



In 2015 and 2020, the U.S. Environmental Protection Agency updated their regulations requiring even tougher standards on emissions. Using our existing technology, Quadra-Fire was able to exceed these new standards ensuring renewable heat sources for generations to come.

WHY QUADRA-FIRE

For more than 30 years, Quadra-Fire has put easy operation and performance above all else. Today these ideals are vibrant and alive, blending our past with our present. Quadra-Fire products are proudly built to last by our members.

WHY WOOD

IT'S RENEWABLE - Using renewable energy sources is more important than ever and wood is 100 percent renewable. When you burn wood, you are also completing the last step of the natural carbon cycle of trees, resulting in a zero net carbon impact on the environment.

IT'S COST-EFFECTIVE - Heating with wood costs less than heating with electricity, liquid propane or heating oil, especially if you harvest wood yourself.

As the fire ignites, it remains clear:
NOTHING BURNS LIKE A QUAD.

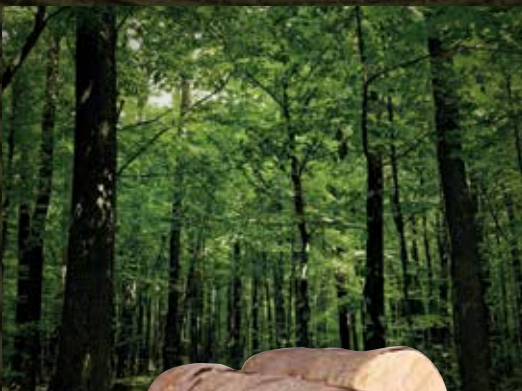

QUADRA-FIRE STEEL WOOD STOVES

At Quadra-Fire we believe that nothing burns like a Quad, and heating with wood should be easy and cost effective.

With four different sizes to choose from and multiple looks to fit any décor, you don't need to look any further for your heating needs.

All this is powered by the following two exclusive technologies.



EXCLUSIVE TECHNOLOGIES

Innovative technology is at work in every Quadra-Fire. These advancements make it possible to burn wood more effectively, efficiently, and with more control.

FOUR-POINT BURN SYSTEM

The patented Quadra-Fire Four-Point Burn System produces intense rolling flames. Four combustion cycles extend the heat, enhance the fire and increase efficiency for long-lasting, proven performance.

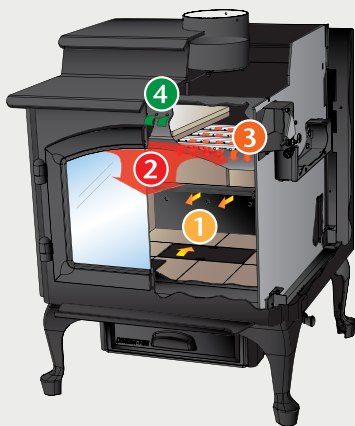

1. PRECISION START-UP

Airflow quickly routes to the heart of the fire.

2. SECONDARY BURN ZONE

Air movement helps create rolling flames and keeps the glass clean.

3. TERTIARY BURN ZONE

Superheated air ignites flammable gases rising from the wood.

4. QUATERNARY BURN ZONE Remaining impurities are burned above the baffle before exiting up the chimney.

AUTOMATIC COMBUSTION CONTROL

Automatic Combustion Control (ACC) is an advanced heat-management technology from Quadra-Fire. ACC feeds the fire with air when it's needed most—for precision start-up or a boost of air when needed.

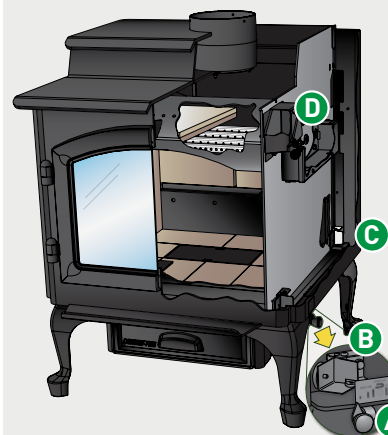

A. ACTIVATION CONTROL KNOB

Push back and pull forward to activate startup airflow.

B. ACC AIR INLET

Controls startup airflow to build the fire.

C. ACC TIMER

Opens ACC air inlet during startup for approximately 20 minutes.

D. BURN RATE CONTROL Controls the airflow feeding the fire, also controls your comfort.

5700 STEP TOP



5700 STEP TOP SHOWN WITH SATIN NICKEL ARCHED DOOR (INCLUDES SATIN NICKEL HINGE PINS AND AIR CONTROL HANDLE) AND TRADITIONAL LEGS

Peak BTU/Hr Output ¹ 72,100	Heating Capacity ² 1,400-3,700 sq ft	Max. Burn Time ³ 15 hrs	Efficiency ⁵ LHV: 80% HHV: 74%	Emissions 1.8 g/h	Firebox 3.0 cu ft	Recommended Log Length 22"	Viewing Area 187 sq in	Actual Weight 434 lbs
---	--	--	---	-----------------------------	-----------------------------	---	----------------------------------	---------------------------------

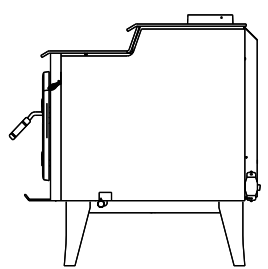
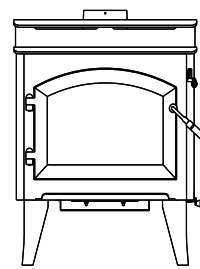
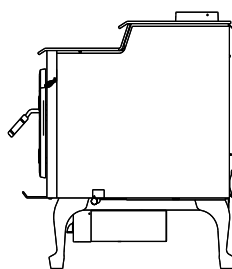
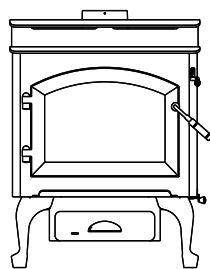
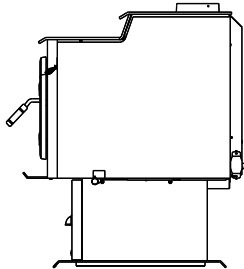
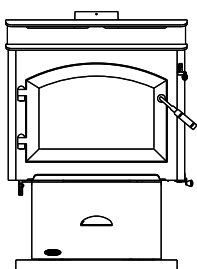

5700 STEP TOP » PEDESTAL BASE » ASH PAN

5700 STEP TOP » QUEEN ANNE LEGS » ASH PAN

5700 STEP TOP » TRADITIONAL LEGS

4300 STEP TOP



4300 STEP TOP SHOWN WITH SATIN NICKEL ARCHED DOOR (INCLUDES SATIN NICKEL HINGE PINS AND AIR CONTROL HANDLE) AND BLACK QUEEN ANNE LEGS

Peak BTU/Hr Output ¹ 61,700	Heating Capacity ² 1,100-3,000 sq ft	Max. Burn Time ³ 12 hrs	Efficiency ⁵ LHV: 80% HHV: 74%	Emissions 1.6 g/h	Firebox 2.3 cu ft	Recommended Log Length 18"	Viewing Area 165 sq in	Actual Weight 315 lbs
---	--	--	---	-----------------------------	-----------------------------	---	----------------------------------	---------------------------------

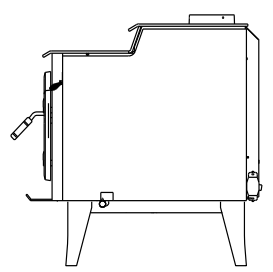
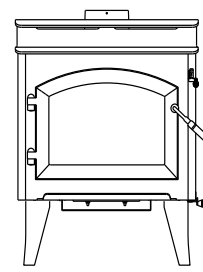
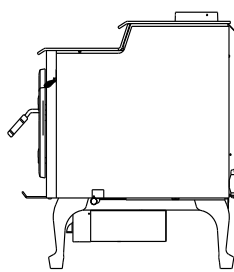
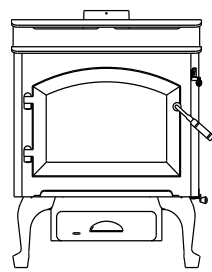
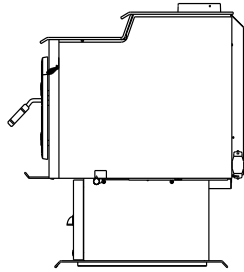
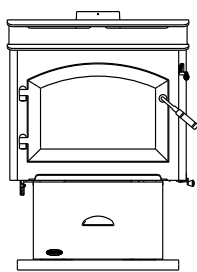

4300 STEP TOP » PEDESTAL BASE » ASH PAN

4300 STEP TOP » QUEEN ANNE LEGS » ASH PAN

4300 STEP TOP » TRADITIONAL LEGS

4300 MILLENNIUM



4300 MILLENNIUM SHOWN STANDARD

Peak BTU/Hr Output ¹ 61,700	Heating Capacity ² 1,100-3,000 sq ft	Max. Burn Time ³ 12 hrs	Efficiency ⁵ LHV: 80% HHV: 74%	Emissions 1.6 g/h	Firebox 2.3 cu ft	Recommended Log Length 18"	Viewing Area 165 sq in	Actual Weight 315 lbs
---	--	--	---	-----------------------------	-----------------------------	---	----------------------------------	---------------------------------

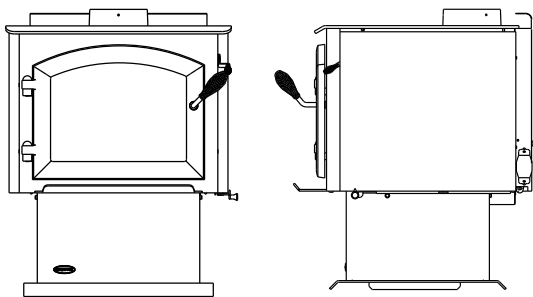

4300 MILLENNIUM

4300

3100 MILLENNIUM



3100 MILLENNIUM SHOWN STANDARD

Peak
BTU/Hr Output¹
51,000

Heating Capacity²
1,000-2,600
sq ft

Max. Burn Time³
10 hrs

Efficiency⁵
LHV: 78%
HHV: 73%

Emissions
1.9 g/h

Firebox
2.0 cu ft

Recommended
Log Length
16"

Viewing Area
165 sq in

Actual Weight
285 lbs

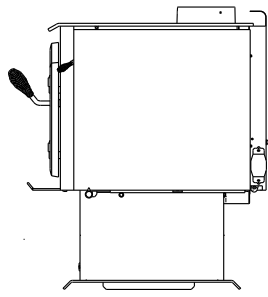
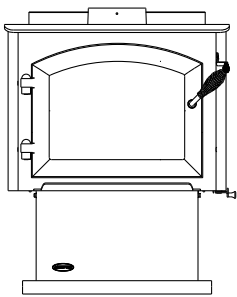

3100 MILLENNIUM

3100

2100 MILLENNIUM



2100 MILLENNIUM SHOWN STANDARD

Peak BTU/Hr Output ¹ 44,400	Heating Capacity ² 800-2,100 sq ft	Max. Burn Time ³ 7 hrs	Efficiency ⁵ LHV: 82% HHV: 76%	Emissions 1.7 g/hr	Firebox 1.4 cu ft	Recommended Log Length 16"	Viewing Area 125 sq in	Actual Weight 260 lbs
---	--	---	---	------------------------------	-----------------------------	---	----------------------------------	---------------------------------

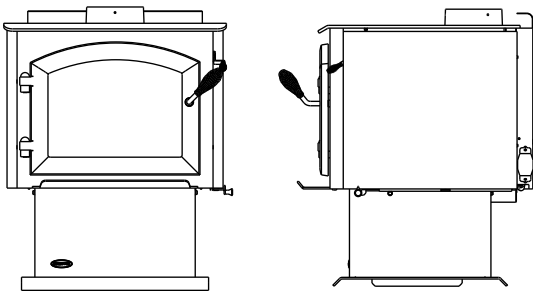

2100 MILLENNIUM

2100

ACCESSORIES



ARCHED DOOR
IN BLACK OR SATIN NICKEL
(INCLUDES MATCHING HINGE PINS
AND AIR CONTROL HANDLE) FOR
STEP TOP STOVES



RECTANGULAR DOOR
FOR 4300 STEP TOP STOVE



DOOR UPGRADE KIT
SATIN NICKEL HINGE PINS, SPRING
HANDLE AND AIR CONTROL HANDLE
(SPRING HANDLE USED ON MILLENNIUM
SERIES ONLY)



QUEEN ANNE LEGS
IN BLACK OR SATIN NICKEL
FOR STEP TOP STOVES
(INCLUDES ASH PAN)



PEDESTAL BASE
FOR STEP TOP STOVES
(INCLUDES ASH PAN)



ASH PAN
INCLUDED WITH QUEEN ANNE LEGS AND
PEDESTAL BASE FOR STEP TOP STOVES ONLY



TRADITIONAL LEGS
FOR 5700 AND 4300 STEP TOP ONLY
(ASH PAN NOT AVAILABLE)



FAN KIT
FOR ALL STOVES



350 CFM FAN KIT
FOR 5700 STEP TOP

STOVE COMPARISON

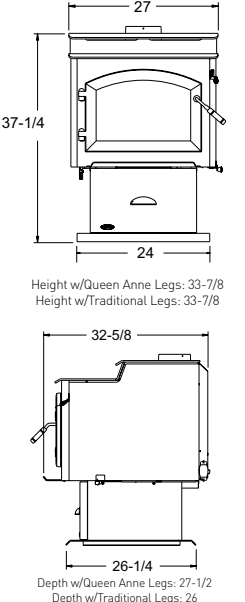
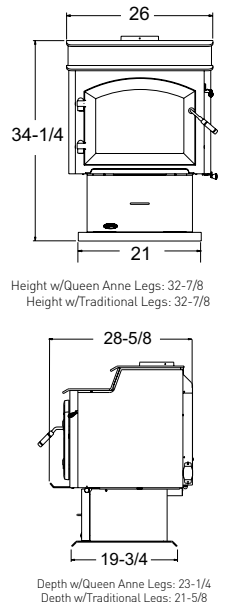
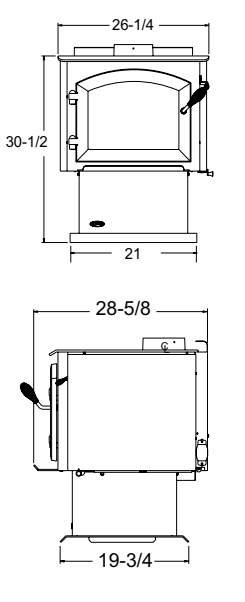
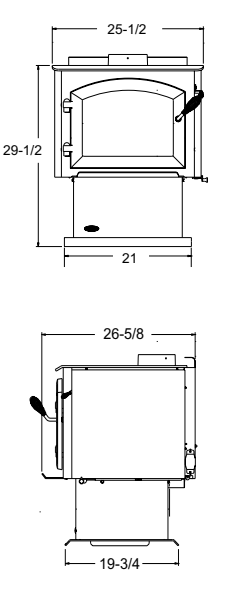
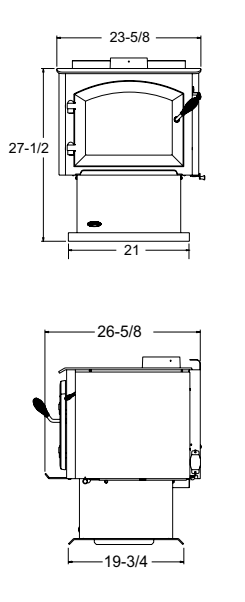
5700 STEP TOP	4300 STEP TOP	4300 MILLENNIUM	3100 MILLENNIUM	2100 MILLENNIUM
 <p>Height w/Queen Anne Legs: 33-7/8 Height w/Traditional Legs: 33-7/8</p> <p>Depth w/Queen Anne Legs: 27-1/2 Depth w/Traditional Legs: 26</p>	 <p>Height w/Queen Anne Legs: 32-7/8 Height w/Traditional Legs: 32-7/8</p> <p>Depth w/Queen Anne Legs: 23-1/4 Depth w/Traditional Legs: 21-5/8</p>	 <p>Height: 30-1/2</p> <p>Depth: 19-3/4</p>	 <p>Height: 29-1/2</p> <p>Depth: 19-3/4</p>	 <p>Height: 27-1/2</p> <p>Depth: 19-3/4</p>
<p>PEAK BTU/HR OUTPUT¹ » 72,100</p> <hr/> <p>HEATING CAPACITY² » 1,400 - 3,700 sq ft</p> <hr/> <p>MAXIMUM BURN TIME³ » 15 hrs</p> <hr/> <p>EFFICIENCY⁵ » 80% LHV » 74% HHV</p> <hr/> <p>EMISSIONS » 1.8 g/hr</p> <hr/> <p>FIREBOX CAPACITY » 3.0 cu ft</p> <hr/> <p>RECOMMENDED LOG LENGTH » 22" max.</p> <hr/> <p>VIEWING AREA » 187 sq in</p> <hr/> <p>ACTUAL WEIGHT » 434 lbs</p>	<p>PEAK BTU/HR OUTPUT¹ » 61,700</p> <hr/> <p>HEATING CAPACITY² » 1,100 - 3,000 sq ft</p> <hr/> <p>MAXIMUM BURN TIME³ » 12 hrs</p> <hr/> <p>EFFICIENCY⁵ » 80% LHV » 74% HHV</p> <hr/> <p>EMISSIONS » 1.6 g/hr</p> <hr/> <p>FIREBOX CAPACITY » 2.3 cu ft</p> <hr/> <p>RECOMMENDED LOG LENGTH » 18" max.</p> <hr/> <p>VIEWING AREA » 165 sq in</p> <hr/> <p>ACTUAL WEIGHT » 315 lbs</p>	<p>PEAK BTU/HR OUTPUT¹ » 61,700</p> <hr/> <p>HEATING CAPACITY² » 1,100 - 3,000 sq ft</p> <hr/> <p>MAXIMUM BURN TIME³ » 12 hrs</p> <hr/> <p>EFFICIENCY⁵ » 80% LHV » 74% HHV</p> <hr/> <p>EMISSIONS » 1.6 g/hr</p> <hr/> <p>FIREBOX CAPACITY » 2.3 cu ft</p> <hr/> <p>RECOMMENDED LOG LENGTH » 18" max.</p> <hr/> <p>VIEWING AREA » 165 sq in</p> <hr/> <p>ACTUAL WEIGHT » 315 lbs</p>	<p>PEAK BTU/HR OUTPUT¹ » 51,000</p> <hr/> <p>HEATING CAPACITY² » 1,000 - 2,600 sq ft</p> <hr/> <p>MAXIMUM BURN TIME³ » 10 hrs</p> <hr/> <p>EFFICIENCY⁵ » 78% LHV » 73% HHV</p> <hr/> <p>EMISSIONS » 1.9 g/hr</p> <hr/> <p>FIREBOX CAPACITY » 2.0 cu ft</p> <hr/> <p>RECOMMENDED LOG LENGTH » 16" max.</p> <hr/> <p>VIEWING AREA » 165 sq in</p> <hr/> <p>ACTUAL WEIGHT » 285 lbs</p>	<p>PEAK BTU/HR OUTPUT¹ » 44,400</p> <hr/> <p>HEATING CAPACITY² » 800 - 2,100 sq ft</p> <hr/> <p>MAXIMUM BURN TIME³ » 7 hrs</p> <hr/> <p>EFFICIENCY⁵ » 82% LHV » 76% HHV</p> <hr/> <p>EMISSIONS » 1.7 g/hr</p> <hr/> <p>FIREBOX CAPACITY » 1.4 cu ft</p> <hr/> <p>RECOMMENDED LOG LENGTH » 16" max.</p> <hr/> <p>VIEWING AREA » 125 sq in</p> <hr/> <p>ACTUAL WEIGHT » 260 lbs</p>

CLEARANCES TO COMBUSTIBLES

STEP TOP SERIES		A	B	C	D	E	F	G
5700 Step Top	Single Wall Pipe	15-3/4"	9"	25-1/2"	12"	4"	16-7/8"	49"
	Double Wall Pipe	13-3/4"	7"	25-1/2"	12"	1"	13-7/8"	49"
4300 Step Top	Single Wall Pipe	18-1/2"	11-3/4"	27-1/2"	14-1/2"	2-1/2"	15"	49-1/2"
	Double Wall Pipe	10-1/2"	3-3/4"	25"	12"	2-1/2"	15"	49-1/2"
MILLENNIUM SERIES		A	B	C	D	E	F	G
4300 Millennium	Single Wall Pipe	18-1/2"	11-3/4"	27-1/2"	14-1/2"	8"	20-1/2"	53-1/2"
	Double Wall Pipe	12"	5-1/4"	27-1/2"	14-1/2"	8"	20-1/2"	53-1/2"
3100 Millennium	Single Wall Pipe	18-1/4"	11-3/4"	28-1/2"	16"	8"	20"	48"
	Double Wall Pipe	13-1/2"	6-1/2"	25"	13"	6-1/2"	18-1/2"	48"
2100 Millennium	Single Wall Pipe	18"	11"	24-1/2"	13"	8-1/2"	20"	56"
	Double Wall Pipe	11-3/4"	5"	23"	11-1/2"	7-1/2"	19"	43"

Backwall / Sidewall

Corner Installation

**STEP TOP SERIES
Stove to Ceiling Clearance**

*Follow pipe manufacturer's clearances as required

**MILLENNIUM SERIES
Stove to Ceiling Clearance**

*Follow pipe manufacturer's clearances as required

Note: 2100 Millennium requires minimum 2' vertical pipe off stove top

HEARTH PROTECTION

HEARTH PROTECTION													
	Hearthpad Type	A	B	C	D	E	F	G	H	I	J	K	L
5700 Step Top	Type I	8"	16"	17-5/8"	44-7/8"	33-5/8"	47"	17-5/8"	34-5/8"	57-3/4"	50"	37-5/8"	62"
4300 Step Top	Type I	8"	16"	15-5/8"	41"	31-5/8"	44-1/4"	15-5/8"	33-1/8"	54-3/4"	44-1/4"	33-1/8"	54-3/4"
4300 Millennium	Type I	8"	16"	15-5/8"	41"	31-5/8"	50-1/4"	15-5/8"	39"	63-1/4"	50-1/4"	39"	63-1/4"
3100 Millennium	Type I	8"	16"	15-5/8"	39"	31-5/8"	47-1/8"	15-5/8"	36"	58-3/4"	48-5/8"	37-1/2"	60-7/8"
2100 Millennium	Type I	8"	16"	13-5/8"	39"	29-5/8"	46-3/4"	13-5/8"	37-1/8"	59-1/4"	47-3/4"	38-1/8"	60-5/8"

NOTE: Reference install manual for requirements in Canada.

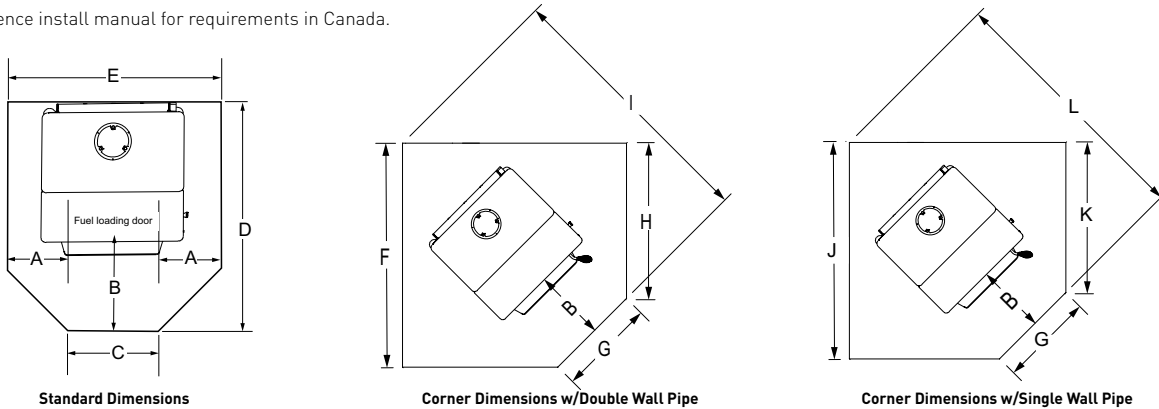



Thank you from everyone at Quadra-Fire

QUADRA-FIRE[®]

NOTHING BURNS LIKE A QUAD

www.quadrafire.com | 800-926-4356

[facebook.com/QuadraFire](https://www.facebook.com/QuadraFire) twitter.com/QuadraFire [youtube.com/QuadraFirePower](https://www.youtube.com/QuadraFirePower)

Available From:

Limited Lifetime Warranty⁴

The strongest in the industry, Quadra-Fire provides a limited lifetime warranty on the most important aspects: firebox and heat exchanger.

1: BTU: 1st hour output uses high burn efficiency number. BTU will vary depending on the type of fuel used and moisture content of the fuel. 2: Heating capacity (in square feet) is a guideline only and may differ due to climate, building construction and condition, amount and quality of insulation, location of the heater, and air movement in the room. 3: Actual burn times will vary based on how the appliance is operated, load size, moisture content and type of wood used, chimney height and installation. 4: For full warranty details go to www.quadrafire.com. 5: Weighted average LHV (Low Heating Value) efficiency. HHV (High Heat Value) efficiency used to qualify products for Tax Credit beginning in 2021.

IMPORTANT - READ BEFORE YOU INSTALL!

Refer to the Owner/Installation Manual for complete clearance requirements and specifications. The images and descriptions in this brochure are provided to assist you in product selection only.

Quadra-Fire is a registered trademark of Hearth & Home Technologies. Product specifications and pricing subject to change without notice.

Fireplace, stove and insert surfaces get extremely HOT and can cause severe burns if touched. Keep a safe distance away. To learn more visit www.quadrafire.com/fireplacesafety.