



# BEYOND FIRE

PRODUCT SHOWN: EVEREST II (OB04016)

**Wood & Pellet**  
*Stoves, Inserts & Fireplaces.*  
**Premium quality**  
**with a unique design**



[WWW.OSBURN-MFG.COM](http://WWW.OSBURN-MFG.COM)



## BEYOND FIRE

**BEYOND... A SINGLE WORD THAT CAPTURES OUR PHILOSOPHY AND COMMITMENT AT OSBURN. THIS IS OUR SOURCE OF INSPIRATION. WHAT DOES "BEYOND" MEAN TO OSBURN?**

*BEYOND drives us forward when we look at products. We go beyond with what we do and with our interactions in life. It is more than building and selling products. It's no longer about just doing, but doing with a purpose, doing efficiently. It is about exceeding expectations. BEYOND... drives us to do better, to be more functional and achieve higher performance. We believe great products define a great appliance manufacturer. We are not afraid to take the lead or to stretch the boundaries. When you go BEYOND..., you simply go ahead; you look at the present and envision amazing things happening for the future.*

*That's who we are, our philosophy. Our hope is to share it with you and we invite you to take the time to **discover how we go beyond.***





PRODUCT SHOWN: **INSPIRE 2000** (OB02042)



IMAGES IN THIS CATALOG  
ARE FOR REFERENCE ONLY.



# SUMMARY

## WOOD STOVES

- 06 950
- 07 1700
- 08 Inspire 2000
- 09 2000
- 10 Matrix
- 11 3300
- 12 3500
- 13 Features and technical data

## WOOD INSERTS

- 15 Matrix 1900
- 16 1700
- 17 Inspire 2000
- 18 2000
- 19 Matrix
- 20 Matrix 2700
- 21 3500
- 22 Features and technical data

## ZERO CLEARANCE WOOD FIREPLACES

- 24 Stratford II
- 25 Everest II
- 26 Horizon
- 27 Features and technical data

## PELLET STOVE

- 28 2500
- 29 Features and technical data

## 33 MAXIMUM RECOMMENDED HEATING AREA

## 34 ACCESSORIES





# 950

STOVE

OB00950

## OPTIONS

- > 100 CFM blower with variable speed control (thermodisc included)
- > Rigid firescreen
- > 5"Ø fresh air intake kit
- > 5"Ø x 4' insulated flex pipe for fresh air intake kit
- > 5"Ø fresh air intake register with airtight damper

Would you like to add a dose of warmth and cozyness to your home? Bring comfort and functionality to your daily life with the Osburn 950, a small wood stove that will quickly become your cold-season essential.

Equipped with high density bricks, a top heat deflector to redirect heat in front of the stove as well as side panels that reduce clearances, the Osburn 950 offers quality and performance. Enjoy your winter evenings more than ever before!

**EMISSIONS:** 1.8 g/h

**RECOMMENDED HEATING AREA:** 250 - 1,200 sq. ft.

**MAXIMUM HEAT OUTPUT:** 45,000 BTU/h

**FIREBOX VOLUME:** 1.7 cu. ft.

**COMBUSTION TECHNOLOGY:** Non-catalytic





PAPYRUS Fireplace tool set (See page 34)

With brushed nickel cast iron straight legs and brushed nickel door overlay.

**1700**  
STOVE

---

OB01700

Designed to meet the needs of smaller spaces, the Osburn 1700 is a faithful copy of the recently redefined 2000 model. This firebox combines robustness and elegance to allow you to enjoy your heating experience with confidence. This unit is equipped with high-density bricks, a cast iron door, a built-in ash pan, a top heat deflector that redirects heat to the front of the unit, and side panels to reduce its clearances.

Choose your favorite version by customizing the unit to suit your style: refined door overlays, new leg designs, glass ash lip. Exceeding air quality regulations with emissions as low as 1.26 g/h, the Osburn 1700's efficiency will save you time and money.

- EMISSIONS:** 1.26 g/h
- RECOMMENDED HEATING AREA:** 500 - 1,800 sq. ft.
- MAXIMUM HEAT OUTPUT:** 65,000 BTU/h
- FIREBOX VOLUME:** 1.9 cu. ft.
- COMBUSTION TECHNOLOGY:** Non-catalytic

**REQUIRED ACCESSORIES**

- > Black or brushed nickel door overlay
- > Choice of pedestal, black or brushed nickel cast iron legs with ash pan kit

**OPTIONS**

- > 130 CFM blower with variable speed control (thermodisc included)
- > Rigid firescreen
- > Glass ash lip
- > 5"Ø fresh air intake kit
- > 5"Ø fresh air intake register with airtight damper
- > 5"Ø x 4' insulated flex pipe for fresh air intake kit

Choice of legs



Pedestal



See the complete technical data on pages 13 and 14.



INEO Fireplace tool set (See page 34)

With soapstone base.

# INSPIRE 2000

STOVE

OB02042

### REQUIRED ACCESSORIES

- > Black decorative side panel
- > Minimalist, steel or soapstone base kit

### OPTIONS

- > Moulded refractory panel kit
- > 130 CFM blower assembly with variable speed control
- > Quick connect thermosdisc
- > 5"Ø fresh air intake kit
- > 5"Ø fresh air intake register with airtight damper
- > 5"Ø x 4' insulated flex pipe for fresh air intake kit

The Inspire 2000 offers a style that will surely withstand variable trends with these pure lines of balanced proportions. This more contemporary look is available on steel base, soapstone or even a minimalist base for those who prefer to place the unit directly on a non-combustible surface. Equipped with a 2.4 cubic feet firebox and an outside air intake, this unit will meet the requirements of domestic energy standards, not to mention that a mobile home installation is permitted. The Inspire 2000 largely meets EPA requirements with emissions as low as 1.54 g/h.

**EMISSIONS:** 1.54 g/h

**RECOMMENDED HEATING AREA:** 500 - 2,100 sq. ft.

**MAXIMUM HEAT OUTPUT:** 75,000 BTU/h

**FIREBOX VOLUME:** 2.4 cu. ft.

**COMBUSTION TECHNOLOGY:** Non-catalytic

Moulded refractory panel kit (option)

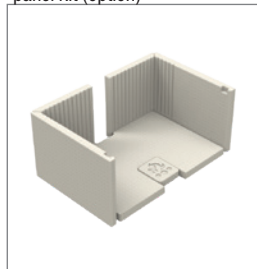

Steel base



Minimalist base



See the complete technical data on pages 13 and 14.





INEO Fireplace tool set (See page 34)

With black cast iron traditional legs and black door overlay.

**2000**  
STOVE

OB02015

The Osburn 2000 is one of the most popular unit in the Osburn family of wood stoves. Its cast-iron door, which features the distinctive lines you've come to expect from Osburn, gives it a look combining the contemporary and the traditional. With a 2.4 cubic foot firebox, the Osburn 2000 will delight the most serious of wood stove enthusiasts who want both style and heating power. Also equipped with a 130 CFM blower, the Osburn 2000 is the most sought-after model of the season!

**EMISSIONS:** 1.54 g/h

**RECOMMENDED HEATING AREA:** 500 - 2,100 sq. ft.

**MAXIMUM HEAT OUTPUT:** 75,000 BTU/h

**FIREBOX VOLUME:** 2.4 cu. ft.

**COMBUSTION TECHNOLOGY:** Non-catalytic

**REQUIRED ACCESSORIES**

- > Black or brushed nickel door overlay
- > Choice of pedestal, black or brushed nickel cast iron legs with ash pan kit

**OPTIONS**

- > Rigid firescreen
- > Glass ash lip
- > Quick connect thermodisc kit
- > 5"Ø fresh air intake kit
- > 5"Ø fresh air intake register with airtight damper
- > 5"Ø x 4' insulated flex pipe for fresh air intake kit

Choice of legs



Pedestal



See the complete technical data on pages 13 and 14.



With soapstone side panels and steel top panel.

# MATRIX

STOVE

OB02032

## REQUIRED ACCESSORIES

- > Soapstone or black side panels kit
- > Soapstone or steel top panel

## OPTIONS

- > Rigid firescreen
- > 5"Ø fresh air intake kit
- > 5"Ø fresh air intake register with airtight damper
- > 5"Ø x 4' insulated flex pipe for fresh air intake kit

The Matrix wood stove's clean and modern lines is sure to bring a European touch to any room. Inspired by a renowned Scandinavian look, the stove has optional soapstone panel top. These Canadian mined soapstones are also available as side panels kit that brings elegance to another level. Logs can be conveniently placed underneath the large firebox, making the Matrix not only stylish, but practical. The Matrix is equipped with a 130 CFM fan to ensure optimal heat distribution. Enjoy the comfort of winter more than ever before!

**EMISSIONS:** 1.54 g/h

**RECOMMENDED HEATING AREA:** 500 - 2,100 sq. ft.

**MAXIMUM HEAT OUTPUT:** 75,000 BTU/h

**FIREBOX VOLUME:** 2.4 cu. ft.

**COMBUSTION TECHNOLOGY:** Non-catalytic

Soapstone or steel top panel

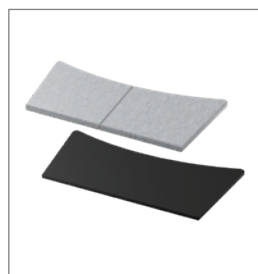

Soapstone panels



Black painted panels



See the complete technical data on pages 13 and 14.



INEO Fireplace tool set (See page 34)

With black cast iron straight legs and brushed nickel door overlay.

The Osburn 3300 represents the essence of eco-friendly and efficient heating. With an emission rate of 0.95 g/h, this non-catalytic wood stove is among the cleanest on the market and represents an environmentally friendly source of energy. This north-south loading model will keep your family warm all night long, even in very cold weather, thanks to its power of 90,000 BTU/h. The design of the heater is flawless and enhanced by a set of high density bricks, a high density insulation panel baffle, a new cast iron door mold, an integrated ash drawer, a top heat deflector as well as decorative side panels.

- EMISSIONS:** 0.95 g/h
- RECOMMENDED HEATING AREA:** 900 - 2,300 sq. ft.
- MAXIMUM HEAT OUTPUT:** 90,000 BTU/h
- FIREBOX VOLUME:** 3.3 cu. ft.
- COMBUSTION TECHNOLOGY:** Non-catalytic

**3300**  
STOVE

---

OB03300

**REQUIRED ACCESSORIES**

- > Black or brushed nickel door overlay
- > Choice of pedestal, black or brushed nickel cast iron legs with ash pan kit

**OPTIONS**

- > 130 CFM blower with variable speed control (thermodisc included)
- > Rigid firescreen
- > Glass ash lip
- > 5"Ø fresh air intake kit
- > 5"Ø fresh air intake register with airtight damper
- > 5"Ø x 4' insulated flex pipe for fresh air intake kit

Choice of legs



Pedestal



See the complete technical data on pages 13 and 14.





DUPLEX Fireplace tool set (See page 34)

# 3500

STOVE

OB03500

With brushed nickel door overlay.

Specifically designed to face the rigor of winter, the Osburn 3500 is an essential for any spacious home, especially if you live in a region with harsh weather conditions. Despite its emissions below 2.0 g/h, this wood stove utilizes a user-friendly, non-catalytic technology as well as a significant reduction of fuel consumption. The unit features a firebox that can hold up to 50 lb of cordwood, as well as a blower, a thermodisc and an airmate for optimal heat distribution and unparalleled comfort.

A choice of door overlay, a firescreen, a glass ash lip are available as options.

### REQUIRED ACCESSORIES

- > Black or brushed nickel door overlay

### OPTIONS

- > Rigid firescreen
- > Glass ash lip
- > 5"Ø fresh air intake kit for pedestal
- > 5"Ø fresh air intake register with airtight damper

**EMISSIONS:** 1.32 g/h

**RECOMMENDED HEATING AREA:** 1,000 - 2,700 sq. ft.

**MAXIMUM HEAT OUTPUT:** 110,000 BTU/h

**FIREBOX VOLUME:** 3.5 cu. ft.

**COMBUSTION TECHNOLOGY:** Non-catalytic



See the complete technical data on pages 13 and 14.

# WOOD STOVES | SPECS



MODELS	950	1700	Inspire 2000	2000	Matrix	3300	3500
Color	Metallic black						
Combustion technology	Non-catalytic						
Maximum burn time (note 1)	5 hours	6 hours	8 hours	8 hours	8 hours	10 hours	10 hours
Recommended heating area (note 1)	250 to 1,200 sq. ft.	500 to 1,800 sq. ft.	500 to 2,100 sq. ft.	500 to 2,100 sq. ft.	500 to 2,100 sq. ft.	900 to 2,300 sq. ft.	1 000 to 2,700 sq. ft.
Maximum heat output - dry cordwood	45,000 BTU/h (13.19 kW)	65,000 BTU/h (19.0 kW)	75,000 BTU/h (22.0 kW)	75,000 BTU/h (22.0 kW)	75,000 BTU/h (22.0 kW)	90,000 BTU/h (26.4 kW)	110,000 BTU/h (32.2 kW)
Average particulate emissions rate	1.8 g/h	1.26 g/h	1.54 g/h	1.54 g/h	1.54 g/h	0.95 g/h	1.32 g/h
Maximum log length	17"	18"	20"	20"	20"	20"	22"
Recommended log length	16"						
Optimum efficiency	80%	78%	77%	77%	77%	78%	77%
Mobile home approved (note 2)	Yes						
Approved for an alcove installation	Yes						
Flue spigot diameter	6"						
Door frame	Cast iron	Cast iron	Steel	Cast iron	Cast iron	Cast iron	Cast iron
Glass viewing area (W x H)	10 1/4" x 8 7/8"	15 3/4" x 9 3/8"	20 1/4" x 9 1/2"	17 1/8" x 10 1/4"	19 5/8" x 11 7/8"	14 1/2" x 11 5/8"	18 7/8" x 11 3/4"
Glass type	Ceramic glass						
Adjustable handle	Yes						
Self-cleaning glass system	Yes						
Ash drawer with safety lid	No	Yes	Yes	Yes	Yes	Yes	Yes
Warranty	Lifetime, limited						
Test standard - Safety	According to ULC S627, UL 1482, UL 737, NFPA 211 and CSA B365 standards applicable in Canada and USA						
Test standard - Emissions / efficiency	EPA / CSA B415.1-10						

Note 1 : Recommended heating area and maximum burn time may vary subject to location in home, chimney draft, heat loss factors, climate, fuel type and other variables.  
The recommended heated area for a given appliance is defined by the manufacturer as its capacity to maintain a minimum acceptable temperature in the designated area in case of a power failure.

Note 2 : Refer to the install manual for mobile home installation details.

WOOD STOVES | DIMENSIONS AND CLEARANCES

MODELS	950	1700	Inspire 2000	2000	Matrix	3300	3500
<b>Dimensions and weight</b>							
Door opening size (W x H)	12" x 7 5/8"	17 1/4" x 8 3/4"	20" x 8 1/4"	17 1/2" x 9"	17 1/2" x 8 3/4"	16" x 12"	19" x 9 7/8"
Firebox dimensions (W x H x D)	14 1/4" x 11 3/4" x 19 1/8"	19 5/8" x 11 7/8" x 13 1/2"	21" x 11 3/4" x 16 3/4"	21" x 11 7/8" x 16 1/2"	21" x 11 7/8" x 16 3/4"	19" x 14 1/8" x 21"	22 7/8" x 20 1/8" x 12 7/8"
Firebox volume	1.7 cu. ft.	1.9 cu. ft.	2.4 cu. ft.	2.4 cu. ft.	2.4 cu. ft.	3.3 cu. ft.	3.5 cu. ft.
Height (pedestal)	N/A	30 3/8"	39 1/2"	33 1/8"	36 7/8"	34"	34 3/4"
Height (legs)	28 7/8"	29"	N/A	30 3/4"	N/A	32 1/4"	N/A
Width (pedestal)	N/A	24 7/8"	27 7/8"	27"	27 1/8"	24 1/4"	28 7/8"
Width (legs)	20 1/4"	25 7/8"	N/A	27"	N/A	24 1/4"	N/A
Depth (pedestal)	N/A	23 1/4"	24 1/4"	29"	25"	30 1/2"	33 1/2"
Depth (legs)	27 7/8"	23 1/4"	N/A	29"	N/A	30 1/2"	N/A
Weight	280 lb (127 kg)	331 lb (150 kg)	537 lb (244 kg)	390 lb (177 kg)	506 lb (230 kg)	465 lb (210 kg)	524 lb (238 kg)

**Clearances from unit to combustible materials (figures 1, 2, and 3)**

With single wall pipe (note 3)							
A— Sides (Canada / USA)	12"	10"	17" / 16"	17" / 16"	17" / 16"	12"	14"
B— Back (Canada / USA)	14" / 12"	14 1/2" / 13"	14 1/2" / 11"	14 1/2" / 11"	14 1/2" / 11"	14 1/2"	13 1/4" / 13"
C— Corner (Canada / USA)	11"	12"	10"	10"	10"	10"	7 1/4"
With double wall pipe							
A— Sides (Canada / USA)	12"	10"	17" / 16"	17" / 16"	17" / 16"	12"	14"
B— Back (Canada / USA)	6"	6"	6"	6"	6"	6"	6"
C— Corner (Canada / USA)	6"	12"	7"	7"	7"	8"	7"
D— Ceiling (Canada / USA) - (note 4)	84"	84"	84"	84"	84"	84"	84"

Note 3: Consult local code for minimum clearances of the single wall pipe itself to combustible materials. See also the venting manufacturer's instructions.

Note 4: Measured from the base of the appliance. Some appliances have been tested with a low ceiling. Before setting up your unit, refer to the installation manual.

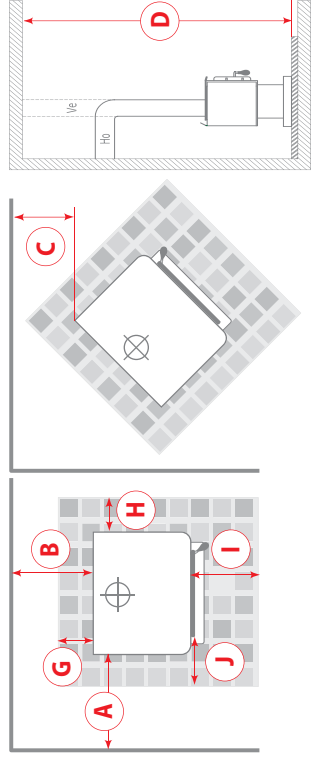

Figure 1

	FLOOR PROTECTOR*	
	CANADA	USA
G	8" – Note **	N/A (Canada only)
H	8"	
I	18" From door opening	16" From door opening
J	N/A (USA only)	8" From door opening

\*Steel with a minimum thickness of 0.015" (0.38 mm) or ceramic tiles sealed together with grout. No protection is required if the unit is installed on a non-combustible floor (ex: concrete).

\*\*The floor protection at the back of the stove is limited to the stove's required clearance if such clearance is smaller than 8 inches (203 mm).

Technical data contained in this brochure are for reference only. Any installation must be done according to the data and drawings detailed in the owner's manual.

Figure 3



With black door overlay.

Treat your family to incomparable comfort with the Matrix 1900 wood-burning insert. Its magnificent cast-iron faceplate is adorned with a patterned upper louver and columns that frame its large door. Its discreet black wooden handle, air control with removable handle as well as flush mount blower disappear to leave room for the delicate details of its faceplate. Its large glass surface highlights a panoramic view of the flames to fully enjoy your moments near the fire.

The Matrix 1900 is a compact unit that has tapered top and sides for easy installation in smaller hearths. The deep bottom of its combustion chamber allows ash to accumulate and reduces the frequency of cleaning.

**EMISSIONS:** 1.5 g/h

**RECOMMENDED HEATING AREA:** 250 - 1,200 sq. ft.

**MAXIMUM HEAT OUTPUT:** 45,000 BTU/H

**FIREBOX VOLUME:** 1.2 cu. ft.

**COMBUSTION TECHNOLOGY:** Non-catalytic

## MATRIX 1900

TAPERED NSERT

OB01900

### REQUIRED ACCESSORIES

- > Black or brushed nickel cast iron door overlay

### OPTIONS

- > Rigid firescreen
- > 5"Ø fresh air intake kit
- > 5"Ø fresh air intake register with airtight damper
- > Offset liner adaptor
- > Cuttable faceplate (32" x 44")





# 1700

INSERT

OB01705

With brushed nickel door overlay and black faceplate trims.

Like its larger counterpart Osburn 2000, the 1700 insert offers a revamped version of perfect size to provide ambiance and warmth. Give yourself a real haven of peace with an eco-friendly device whose average particle emission rate is remarkably low at 1.26 g/h!

Inside and out, this insert is engineered from high quality materials that put you at the center of a heating experience for many years: high-density bricks, cast iron door and quiet blower for increased durability. Discover the different options to customize the look of your appliance, available in black or brushed nickel: door overlays and faceplate trims.

*A faceplate extension is included with this unit for installation in most hearths.*

**EMISSIONS:** 1.26 g/h

**RECOMMENDED HEATING AREA:** 500 - 1,800 sq. ft.

**MAXIMUM HEAT OUTPUT:** 65,000 BTU/h

**FIREBOX VOLUME:** 1.9 cu. ft.

**COMBUSTION TECHNOLOGY:** Non-catalytic

### REQUIRED ACCESSORIES

- > Black or brushed nickel door overlay
- > Faceplate kit  
Regular (29" x 44") or  
Large (32" x 50")
- > Black or brushed nickel  
faceplate trims

### OPTIONS

- > Offset liner adaptor
- > 5"Ø fresh air intake kit
- > 5"Ø fresh air intake register  
with airtight damper
- > Rigid firescreen

Black or brushed nickel faceplate trims



See the complete technical data on pages 22 and 23.





With narrow faceplate (4-sided)

This wood insert will bring an unmatched modernism to your decor, in addition to perfectly combining functionality and comfort. The impeccable lines display a timeless style while guaranteeing reliability and durability. The Inspire 2000 will charm you as much by its aesthetics as its 77% optimal performance. With its particle emission rate as low as 1.54 g/h and its high-performance combustion system, environmentalists have never been as happy with wood heating. The Inspire Collection celebrates our past and embraces our future as our team is committed more than ever to our industry's contribution to sustainability. A dream opportunity on the latest trends!

**EMISSIONS:** 1.54 g/h

**RECOMMENDED HEATING AREA:** 500 - 2,100 sq. ft.

**MAXIMUM HEAT OUTPUT:** 75,000 BTU/h

**FIREBOX VOLUME:** 2.4 cu. ft.

**COMBUSTION TECHNOLOGY:** Non-catalytic

# INSPIRE 2000

INSERT

OB02045

## REQUIRED ACCESSORIES

- > Narrow, narrow U shape or cuttable faceplate (32" x 50")

## OPTIONS

- > Moulded refractory panel kit for insert
- > 5"Ø fresh air intake kit
- > 5"Ø fresh air intake register with airtight damper
- > Offset liner adaptor

Narrow faceplate  
(4-sided)



Narrow U shaped faceplate  
(3-sided)



Cuttable faceplate





Papyrus Fireplace tool set (See page 34)

# 2000

INSERT

OB02016

With brushed nickel door overlay, regular faceplate kit and brushed nickel faceplate trims.

With its 2.4 cubic foot firebox, the Osburn 2000 insert offers an alternative to the people who love its freestanding counterpart. The two models share the same high quality combustion properties and many of the same features. The Osburn 2000 comes with a standard high-power, heat-activated 144 CFM blower strategically positioned to redistribute the heat from the firebox into the room. The 2000 model is designed to receive an optional faceplate that can cover a masonry hearth up to 32 inches (81 cm) high and 50 inches (127 cm) wide. The door overlay is available in black or brushed nickel finishes. The faceplate trims are available in black or brushed nickel.

*A faceplate extension is included with this unit for installation in most hearths.*

**EMISSIONS:** 1.54 g/h

**RECOMMENDED HEATING AREA:** 500 - 2,100 sq. ft.

**MAXIMUM HEAT OUTPUT:** 75,000 BTU/h

**FIREBOX VOLUME:** 2.4 cu. ft.

**COMBUSTION TECHNOLOGY:** Non-catalytic

## REQUIRED ACCESSORIES

- > Black or brushed nickel door overlay
- > Faceplate kit  
Regular (29" x 44") or  
Large (32" x 50")
- > Black or brushed nickel faceplate trims

## OPTIONS

- > Cuttable faceplate (32" x 50")
- > Rigid firescreen
- > Heat shield for surround/shelf
- > 5"Ø fresh air intake kit
- > 5"Ø fresh air intake register with airtight damper
- > Offset liner adaptor

Black or brushed nickel faceplate trims



See the complete technical data on pages 22 and 23.



# MATRIX

INSERT

OB02028

The Matrix 2000 wood insert defines the new standards for contemporary look and performance. This appliance looks like a fireplace, but has all the advantages of an insert. It's faceplate and blower assembly were developed to allow a flush finish with the masonry fireplace. Cast iron was selected as the material of choice for this clean and modern unit. Installation into larger openings is facilitated by the use of an optional sheet metal backing plate. This insert will surely become the focal point of the room.

**EMISSIONS:** 1.54 g/h

**RECOMMENDED HEATING AREA:** 500 - 2,100 sq. ft.

**MAXIMUM HEAT OUTPUT:** 75,000 BTU/h

**FIREBOX VOLUME:** 2.4 cu. ft.

**COMBUSTION TECHNOLOGY:** Non-catalytic

## OPTIONS

- > Bottom faceplate backing plate panels (44" x 6" / 50" x 6")
- > Faceplate backing plate (29" x 44" / 29" x 50")
- > Projection kit for insert 2" or 4"
- > Rigid firesceen
- > 5"Ø fresh air intake kit
- > 5"Ø fresh air intake register with airtight damper
- > Offset liner adaptor





INVED Fireplace tool set (See page 34)

# MATRIX 2700

TAPERED INSERT

OB02700

With brushed nickel door overlay.

Inspired by nature, the Matrix 2700 insert is a fusion of traditional style and technological innovation. Located in the heart of your living space, the generous viewing area of the Matrix 2700 will invite you to sit back, relax and take in the calm and warmth of its flames. Eco-savvy consumers will appreciate its efficient combustion, quality performance and classic beauty.

This unit comes standard with cast iron faceplate and heat activated blower. Customize the look of this non-catalytic appliance by choosing from a black or brushed nickel door overlay and firescreen.

**EMISSIONS:** 1.14 g/h

**RECOMMENDED HEATING AREA:** 750 - 2,200 sq. ft.

**MAXIMUM HEAT OUTPUT:** 80,000 BTU/h

**FIREBOX VOLUME:** 2.5 cu. ft.

**COMBUSTION TECHNOLOGY:** Non-catalytic

**REQUIRED ACCESSORIES**

- > Black or brushed nickel cast iron door overlay

**OPTIONS**

- > Cuttable faceplate (34" x 50")
- > Projection kit for insert 2" or 4"
- > Firescreen door
- > 5"Ø fresh air intake kit
- > 5"Ø fresh air intake register with airtight damper
- > Offset liner adaptor

Projection kit (option)

Tapered insert for easier installation in masonry hearth

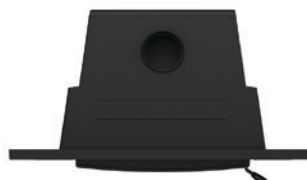

See the complete technical data on pages 22 and 23.



With brushed nickel door overlay, large faceplate kit and brushed nickel faceplate trims.

The Osburn 3500 wood insert combines power, efficiency and safety. With its amazing features and sober lines that give way to one of the largest glass surfaces in its category, this insert will blend perfectly with the architecture of your home. Its flawless design reveals all the Canadian know-how in terms of alternative heating and will quickly become the house favorite. No harsh winter can resist it!

Because each house is unique, choose the door overlay, the faceplate and the trims that suit you!

**EMISSIONS:** 1.32 g/h

**RECOMMENDED HEATING AREA:** 1,000 - 2,700 sq. ft.

**MAXIMUM HEAT OUTPUT:** 110,000 BTU/h

**FIREBOX VOLUME:** 3.5 cu. ft.

**COMBUSTION TECHNOLOGY:** Non-catalytic

Black or brushed nickel faceplate trims



**3500**  
INSERT

OB03510

**REQUIRED ACCESSORIES**

- > Black or brushed nickel door overlay
- > Faceplate kit  
Medium (32" x 44") or  
Large (32" x 50")
- > Black or brushed nickel faceplate trims

**OPTIONS**

- > Firescreen door
- > 5"Ø fresh air intake kit
- > 5"Ø fresh air intake register with airtight damper
- > Offset liner adaptor



See the complete technical data on pages 22 and 23.

WOOD INSERTS | SPECS



MODELS	Matrix 1900 Tapered Insert	1700 Insert	Inspire 2000 Insert	2000 Insert	Matrix Insert	Matrix 2700 Tapered Insert	3500 Insert
Color	Metallic Black						
Combustion technology	Non-catalytic						
Maximum burn time (Note 1)	7 hours	6 hours	8 hours	8 hours	8 hours	8 hours	10 hours
Recommended heating area (Note 1)	250 to 1,200 sq. ft.	500 to 1,800 sq. ft.	500 to 2,100 sq. ft.	500 to 2,100 sq. ft.	500 to 2,100 sq. ft.	750 to 2,200 sq. ft.	1,000 to 2,700 sq. ft.
Maximum heat output - dry cordwood	45,000 BTU/h (13.18 kW)	65,000 BTU/h (19.0 kW)	75,000 BTU/h (22.0 kW)	75,000 BTU/h (22.0 kW)	75,000 BTU/h (22.0 kW)	80,000 BTU/h (23.44 kW)	110,000 BTU/h (32.2 kW)
Average particulate emissions rate	1.5 g/h	1.26 g/h	1.54 g/h	1.54 g/h	1.54 g/h	1.14 g/h	1.32 g/h
Glass viewing area (W x H)	18" x 8 1/8"	15 3/4" x 9 3/8"	20 1/4" x 9 1/2"	17 1/8" x 10 1/4"	19 5/8" x 11 7/8"	24 3/8" x 12 5/8"	19" x 11 3/4"
Maximum log length	17"	18"	20"	20"	20"	20"	22"
Recommended log length:	16"						
Optimum efficiency	82%	78%	77%	77%	77%	74%	77%
Flue spigot diameter	6"						
Door frame	Cast iron	Cast iron	Steel	Cast iron	Cast iron	Cast iron	Cast iron
Glass type	Ceramic glass						
Adjustable handle	Yes						
Self-cleaning glass system	Yes						
Warranty	Lifetime, limited						
Test standard - Safety	According to UL 1482, UL 737, ULC S628, NFPA 211 and CSA B365 applicable in Canada and the United States						
Test standard - Emissions / efficiency	EPA / CSA B415.1-10						

Note 1 : Recommended heating area and maximum burn time may vary subject to location in home, chimney draft, heat loss factors, climate, fuel type and other variables. The recommended heated area for a given appliance is defined by the manufacturer as its capacity to maintain a minimum acceptable temperature in the designated area in case of a power failure.

# WOOD INSERTS | DIMENSIONS AND CLEARANCES

## MODELS

**Matrix 1900**  
Tapered Insert

**1700**  
Insert

**Inspire 2000**  
Insert

**2000**  
Insert

**Matrix**  
Insert

**Matrix 2700**  
Tapered Insert

**3500**  
Insert

### Dimensions and weight

Door opening size (W x H)	18 1/4" x 7 7/8"	17 1/4" x 8 3/4"	20" x 8 1/4"	17 1/2" x 9"	17 1/2" x 8 3/4"	25 3/8" x 10 1/2"	19" x 9 7/8"
Firebox dimensions (W x H x D)	19 1/4" x 8 7/8" x 12 3/8"	19 5/8" x 13 1/2" x 11 7/8"	21" x 11 3/4" x 16 3/4"	21" x 11 7/8" x 16 3/4"	21" x 11 7/8" x 16 3/4"	20 1/2" x 12 7/8" x 12 3/8"	22 7/8" x 12 7/8" x 20 1/8"
Firebox volume	1.2 cu. ft.	1.9 cu. ft.	2.4 cu. ft.	2.4 cu. ft.	2.4 cu. ft.	2.5 cu. ft.	3.5 cu. ft.
Height	20 1/4"	21 1/4"	24 3/8"	23 1/8"	25 1/8"	30 1/8"	24 7/8"
Width	28 1/4"	27 1/8"	28 1/2"	28 3/8"	36 1/8"	43 5/8"	30 3/8"
Depth	21"	22 3/8"	20 3/4"	26 3/8"	23 1/8"	24 7/8"	29"
Weight	332 lb (150 kg)	361 lb (164 kg)	420 lb (191 kg)	407 lb (185 kg)	484 lb (220 kg)	535 lb (243 kg)	540 lb (245 kg)

### Clearances from unit to combustible materials (see figure 1)

A- Adjacent sidewall	16"	16"	16"	16"	16"	16"	19"
B- Combustible side surround	1"	9"	9"	9"	9"	9 1/2"	9"
C- Combustible top surround	1"	27"	27"	27"	27"	12"	27"
D- Maximum depth of a combustible shelf	12"	12"	12"	12"	12"	12"	12"
E- Minimum clearance from a combustible mantle shelf	15 1/4"	27"	27"	27"	27"	12"	27"
F, G, H- Minimum fireplace opening (Height x Width x Depth)	25 1/2" x 15 1/2" x 19"	21 1/2" x 27 1/2" x 12 7/8"	24 5/8" x 29" x 20 3/4"	23 3/8" x 28 7/8" x 15 3/4"	23 3/8" x 28 7/8" x 19 5/8"	27 1/8" x 31 3/4" x 22 1/8"	26 1/4" x 31" x 18 3/8"
I- Minimum floor protection in front of unit (CAN / USA)	18" / 16"	18" / 16"	18" / 16"	18" / 16"	18" / 16"	18" / 16"	27"

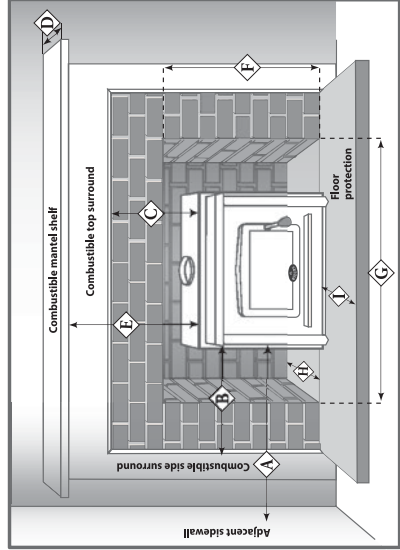

**Figure 1**

\* The depth of the Matrix and Matrix 2700 may vary with the use of the projection kit. Consult the install manual for details.

Technical data & sizes contained in this brochure are for reference only. Any installation must be done according to the data and drawings detailed in the owner's manual.



## STRATFORD II

FIREPLACE

With brushed nickel cast iron door overlay and Prairie-style faceplate.

OB04007

### REQUIRED ACCESSORIES

- > Black or brushed nickel door overlay
- > Traditional or Prairie style faceplate

### OPTIONS

- > 4"Ø fresh air intake kit
- > 4"Ø fresh air intake register with airtight damper
- > Firescreen door
- > Forced air kit
- > Hot air gravity kit
- > 6"Ø x 25' insulated flex pipe for forced air kit
- > 4"Ø X 10' insulated flex pipe for fresh air intake kit



Let yourself be charmed by the timeless beauty of this non-catalytic wood fireplace, which performs particularly well and meets the EPA's most restrictive emissions standards.

The Stratford II offers you more, including a 2.5 cubic foot firebox that's easy to access through double-cast iron doors. This unit will impress you with its distinctive style and exceptional heating capacity. Several options are available, including a air distribution system for heating adjacent rooms (see page 28). With the Osburn Stratford II, there's a world of possibilities waiting for you!

**EMISSIONS:** 1.14 g/h

**RECOMMENDED HEATING AREA:** 750 - 2,200 sq. ft.

**MAXIMUM HEAT OUTPUT:** 80,000 BTU/h

**FIREBOX VOLUME:** 2.5 cu. ft.

**COMBUSTION TECHNOLOGY:** Non-catalytic

Prairie style faceplate

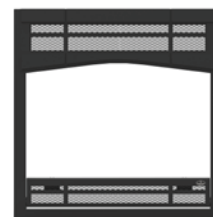

Traditional style faceplate



See the complete technical data on page 27.





With brushed nickel door overlay.

## EVEREST II FIREPLACE

OB04016

Attractive, efficient and particularly ecological, the all-new Everest II is the ultimate addition to revive any living space. The classicism of its faceplate offers straight lines that suits any decor to enhance your family reunions, moments of relaxation or romantic evenings, in addition to being your best ally during the cold winter weather.

Made with care in Quebec, this easy-to-use non-catalytic wood fireplace has retractable cast iron double doors that you can enhance with a firescreen door to fully experience the crackle of the wood fire. A black or brushed nickel overlay is available for your convenience.

**EMISSIONS:** 0.99 g/h

**RECOMMENDED HEATING AREA:** 750 - 2,500 sq. ft.

**MAXIMUM HEAT OUTPUT:** 85,000 BTU/h

**FIREBOX VOLUME:** 3.0 cu. ft.

**COMBUSTION TECHNOLOGY:** Non-catalytic

### REQUIRED ACCESSORIES

- > Black or brushed nickel door overlay
- > Traditional style faceplate

### OPTIONS

- > Hot air gravity kit traditional style
- > Forced air kit
- > Firescreen door
- > 4"Ø fresh air intake register with airtight damper
- > 6"Ø x 25' insulated flex pipe for forced air kit
- > 4"Ø X 10' insulated flex pipe for fresh air intake kit





## HORIZON FIREPLACE

OB04010

### REQUIRED ACCESSORIES

- > Prairie-style faceplate
- > Classic moulded refractory brick panels

### OPTIONS

- > 5"Ø fresh air intake register with airtight damper
- > Warm air circulation grille - Modern style
- > Forced air kit
- > 6"Ø x 25' insulated flex pipe for forced air kit
- > 4"Ø X 10' insulated flex pipe for fresh air intake kit



This wood fireplace offers peace of mind due to the combination of energy efficiency and clean heating.

A simple solution; its clean design suits any type of decor.

**Large fireplace.** Behind its large glass door, the 4.28 cubic foot combustion chamber can hold an impressive 60 lbs of wood. **Low emissions.** This energy efficient fireplace complies with the EPA's clean-air standards (only 1.6 g/h of emissions). **High efficiency.** The Horizon fireplace is capable of heating large spaces and burns for 11 hours.

**EMISSIONS:** 1.6 g/h

**RECOMMENDED HEATING AREA:** 1,000 - 2,800 sq. ft.

**MAXIMUM HEAT OUTPUT:** 95,000 BTU/h

**FIREBOX VOLUME:** 4.28 cu. ft.

**COMBUSTION TECHNOLOGY:** Non-catalytic

Classic moulded refractory brick panels



See the complete technical data on page 27.

## WOOD FIREPLACES | SPECIFIC FEATURES, DIMENSIONS AND CLEARANCES



MODELS	Stratford II	Everest II	Horizon
Color	Metallic black		
Combustion technology	Non-catalytic		
Maximum burn time (note 1)	8 hours	9 hours	11 hours
Recommended heating area (note 1)	750 to 2,200 sq. ft.	750 to 2,500 sq. ft.	1,000 to 2,800 sq. ft.
Maximum heat output - dry cordwood	80,000 BTU/h (23.5 kW)	85,000 BTU/h (24.9 kW)	95,000 BTU/h (27.8 kW)
Average particulate emissions rate	1.14 g/h	0.99 g/h	1.6 g/h
Glass viewing area (W x H)	22 1/4" x 12 1/2"	18 3/4" x 11 3/8"	29 3/4" x 13 1/2"
Door frame	Double, glass with cast iron frame		
Maximum log length	20"	18"	25"
Recommended log length:	16"		
Log positioning	East-west		
Optimum efficiency	74 %	72 %	69.7 %
Mobile home approved	No		
Flue spigot diameter	6"	6"	8"
Glass type	Ceramic glass		
Adjustable handle	Yes		
Self-cleaning glass system	Yes		
Warranty	Lifetime, limited		
Test standard - Safety	As per ULC-S610 / UL 127 applicable in Canada and in the USA		
Test standard - Emissions / efficiency	EPA / CSA B415.1-10		

### Dimensions and weight

Door opening dimensions (W x H)	25 3/8" x 10 1/2"	20 3/4" x 10 1/4"	33" x 12 3/4"
Firebox dimensions (W x D x H)	20 3/8" x 12 7/8" x 12 1/8"	18 7/8" x 16 1/4" x 16 7/8"	25 3/8" x 17 7/8" x 17"
Firebox volume	2.5 cu. ft.	3.0 cu. ft.	4.28 cu. ft.
Height	40 5/8"	49 1/8"	43 3/8"
Width	36 3/4"	41 3/4"	50 3/4"
Depth	29 3/4"	28 5/8"	31 3/4"
Weight	468 lb (212 kg)	525 lb (238 kg)	550 lb (250 kg)

### Clearances to combustible materials (see image below)

A- Side wall	13"								21"								24"							
B- Combustible mantle shelf dimension	6"		8"		10"		12"		6"		8"		10"		12"		Non-combustible only							
Minimum clearance from a mantle shelf (from the base of the fireplace)	58"		60"		62"		64"		48"		50"		52"		54"									
C- Side mantle	8"								8"								8"							
D- Minimum floor protection — front	16"								16"								32"							
E- Minimum floor protection — width	41 1/2"								36 3/4"								49"							
Back wall	0"								0"								0"							
Sides	0"								0"								0"							
Floor (under the fireplace)	0"								0"								0"							
Ceiling (from the base of the fireplace)	80"								80"								84"							

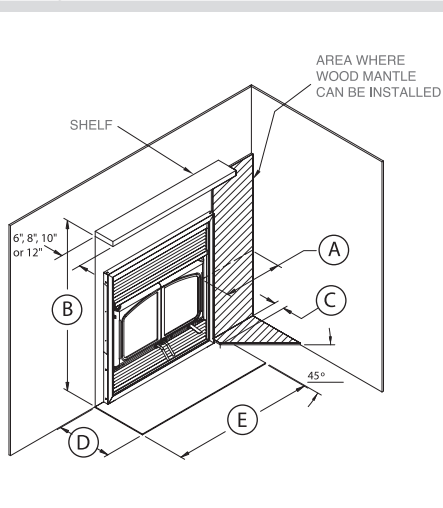

### LISTED CHIMNEYS, MANUFACTURERS, BRANDS AND TYPES (SEE NOTE 2): WOOD FIREPLACES

MANUFACTURERS	BRANDS	TYPES	Stratford II	Everest II	Horizon
Olympia Chimney/SBI Venting Division	Ventis	1" Solid Pack	X	X	X
SBI Venting Division	Nexvent	1" Solid Pack	X	X	X
Olympia Chimney	Champion Chimney System	1" Solid Pack	X	X	X
Olympia Chimney	Rockford Chimney System	1" Solid Pack	X	X	X
American Metal	HSS	AC Triple Wall	X	X	X
American Metal	HS	AC Triple Wall	X	X	X
DuraVent	Dura Tech	1" Solid Pack	X	X	X
DuraVent	Dura Tech Canada DTC	1" Solid Pack	X	X	X
DuraVent	Dura Plus HTC	2" Solid Pack	X	X	X
DuraVent	Dura Plus	AC Triple Wall	X	X	X
DuraVent	Dura Tech Premium	2" Solid Pack	X	X	X
Metal Fab	Temp Guard	1" Solid Pack	X	X	X
Security Chimney	S-2100 +	2" Solid Pack	X	X	X
Selkirk	Super Vent 2100 (JM)	2" Solid Pack	X	X	X
Selkirk	CF Sentinel (CF)	2" Solid Pack	X	X	X
Selkirk	Super Pro 2100 (ALT)	2" Solid Pack	X	X	X

Note 1 : Recommended heating area and maximum burn time may vary subject to location in home, chimney draft, heat loss factors, climate, fuel type and other variables. The recommended heated area for a given appliance is defined by the manufacturer as its capacity to maintain a minimum acceptable temperature in the designated area in case of a power failure.

Note 2 : Specific components may be required depending on the chimney manufacturer.

*Technical data contained in this brochure are for reference only. Any installation must be done according to the data and drawings detailed in the owner's manual.*

# IT'S NOW TIME TO MANAGE HEAT DISTRIBUTION!

EPA certified wood fireplaces generate a lot of heat. For the most part, they generate too much for the room where they are located. Therefore, you need to manage the excess heat and send it where it is needed. To provide a solution, our research and development laboratory has designed the Heat Management System, an innovative technology that allows the recovery of the heat produced during combustion to redirect it into distribution ducts to heat other areas in your home.

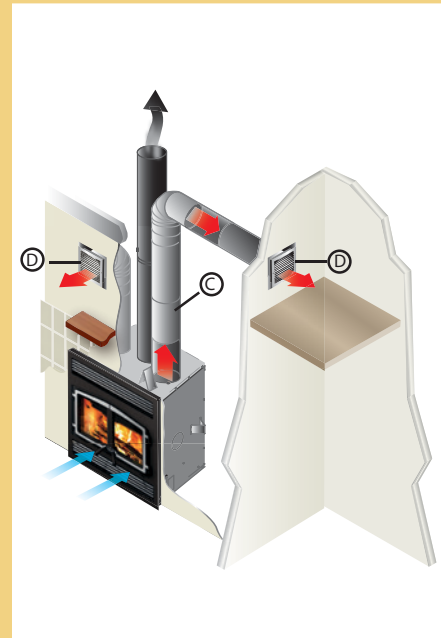
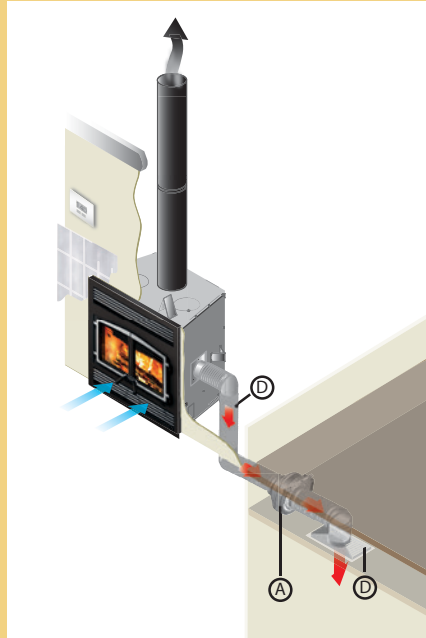
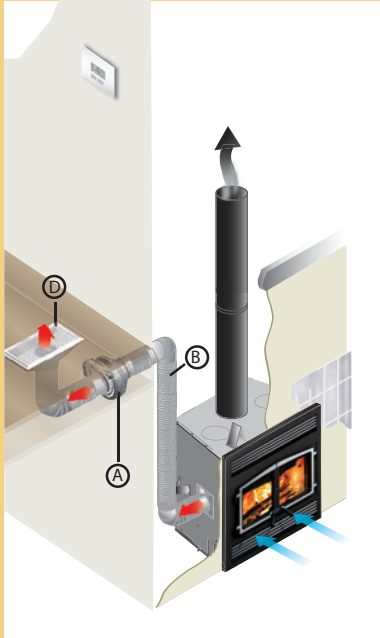

## Forced air kit

This system allows you to manage the heat distribution automatically. Using a wall thermostat, you can select the temperature you want to maintain in the room where the fireplace is located. Once the thermostat is satisfied, the excess heat is redirected to another room up to 50 feet (15 m) away from the fireplace using a 300 CFM blower. That way, you can enjoy a nice fire in your living room without the discomfort of excess heat generated by your Osburn fireplace.

The system can also be used to supplement heat in a room remote from the fireplace. For this type of application, the thermostat needs to be positioned in the desired room and programmed with the temperature to be maintained. The system, now in "heat mode", will activate the blower as long as the temperature in the remote room is not achieved and that the fireplace has enough heat to distribute.

*Osburn also offers you another way to distribute excess heat into your home with the help of a hot air gravity kit.*

## Hot air gravity kit

The hot air gravity kit allows you to bring hot air into the same room as the fireplace, in adjacent rooms, or up-stairs at a maximum distance of 10' (3 m). The minimum height of the hot air duct must be 68" (1.7 m) measured from the base of the fireplace to the top of the hot air register.

Suggested installation : A) 300 CFM blower B) Hot air flexible pipe C) Hot air rigid pipe D) Air register.

The information contained in this page is for information purposes only. For a detailed part list of kits content, please refer to the owner's manuals.

For more details about the installation requirement of the **forced air kit** or the **hot air gravity kit**, visit:  
[www.osburn-mfg.com/en/service-support/heat-distribution-system](http://www.osburn-mfg.com/en/service-support/heat-distribution-system)



# 2500

PELLET STOVE

OP00025

The Osburn 2500 pellet stove is an entry-level appliance, roughly comparable to the 3000 model, whose appearance is more like that of a conventional wood stove. Although slightly different in some respects than its congener, it still retains the same distinctive signs of the brand.

This pellet stove is **made from high-quality materials**: Canadian steel of a higher grade, glass ceramic imported from Germany, heat exchangers made of stainless steel and thermosetting powder paint. Despite these real assets, worthy of a remarkable design, this product is offered at a **very competitive price** in addition to being eligible for certain credits and programs (government incentives).

Responding largely to the next highest standards of solid fuels and environmental protection, the Osburn 2500 has an incredibly low average of **particles emission rate below 0.96 g/h**.

Thanks to **easy installation**, intuitive electronic control and easy to use thermostatic control, the Osburn 2500 is for anyone who wants nothing complicated. It is also **easy to clean** with access to removable components without tools.

**EMISSIONS:** 0.96 g/h

**RECOMMENDED HEATING AREA:** 500 - 2,000 sq. ft.

**MAXIMUM HEAT INPUT RATE:** 39,260 BTU/h

**OVERALL DIMENSIONS:** 33" H x 25 7/8" W x 30" D

**LOADING CAPACITY:** 60 lb

## OPTIONS

- > 3"Ø x 5' Fresh air intake kit
- > Hopper extension
- > Storage tank with pneumatic self-feeding pellet system
- > Storage tank extension
- > Stand alone auxiliary discharge tank
- > Leg assembly for discharge tank
- > Thermostatic control on-off remote
- > 3"Ø x 10' Insulated flex pipe for fresh air intake kit
- > Digital wall thermostat
- > Remote control programmable thermostatic



## GENERAL FEATURES

MODEL	Osburn 2500
Color	Metallic black
Maximum burn time (note 1)	51 hours
Recommended heating area (note 1)	500 to 2,000 sq. ft.
Maximum heat input rate (note 2)	39,260 BTU/h (11.5 kW)
Overall heat output rate (min. to max.) (note 2)	6,648 BTU/h (1.9 kW) to 28,540 BTU/h (8.3 kW)
Hopper capacity (note 2)	60 lb (27 kg)
Combustion technology	Top-feed
Number of intensity levels	6
Electronic igniter	Yes
Glass surface – dimensions (Width x Height)	17 1/4" x 9 1/2"
Approved vent diameter	3" or 4" (as per ELV)
Glass type	Ceramic glass
Ash drawer	Yes
Approved for a mobile home installation (note 3)	Yes
Approved for an alcove installation	Yes
Warranty	Limited lifetime
Average particulate emissions rate	0.96 g/h
Optimum efficiency	78.4%
Noise level at 6 feet	Min : 47 dBA (+/- 3 dBa) – Max : 60 dBA (+/- 3 dBa)
Test standard - safety	ULC S627, CSA B365, ASTM E1509, UL 1482, NFPA 211
Test standard - emissions	EPA / CSA B415.1-10
<b>Exterior dimensions and weight</b>	
Height	33"
Width	25 7/8"
Depth	30"
Weight	275 lb (125 kg)
3" Fresh air intake adapter	Included
3" Fresh air intake kit	Optional

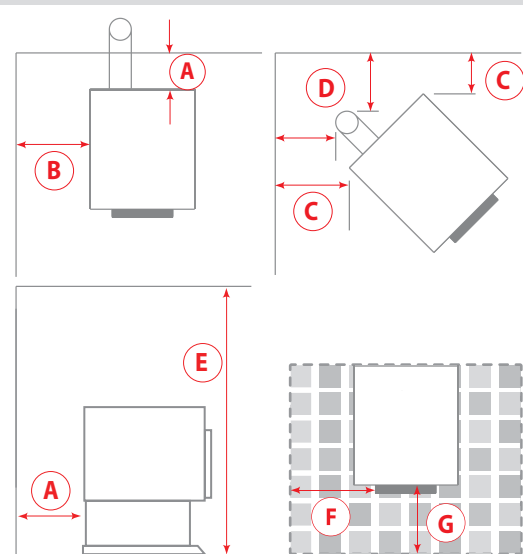

CLEARANCES TO COMBUSTIBLE MATERIALS*		
	CANADA	USA
A**	3"	3"
B	6"	6"
C	3"	3"
D	Refer to vent manufacturer's clearances	
E***	48"	48"
FLOOR PROTECTION		
F	6" ****	6"
G	6" ****	6"

**CAUTION:**  
THE STOVE MUST BE PLACED ON A CONTINUOUS (GROUTED JOINTS) NON COMBUSTIBLE MATERIAL SUCH AS CERAMIC TILE †, CEMENT BOARD, BRICK, MILLBOARD OR EQUIVALENT, OR ANY OTHER APPROVED OR LISTED MATERIAL SUITED FOR FLOOR PROTECTION.

† Any type of tile will require a continuous non combustible sheet beneath to prevent the possibility of embers falling through to the combustible floor if cracks or separation should occur in the finished surface, this would include floor protection for built-in raised hearths. Check local codes for approved alternatives.

\*We recommend leaving 24" on each side of the stove and 12" at the back of the stove in order to facilitate access for maintenance. \*\*From the rear panel. \*\*\* Measured from the platform on which the product is installed. \*\*\*\* In Canada, the dimensions of the floor protection can be used ONLY if opening the appliance door or removing the ash drawer is done when the appliance is OFF completely, meaning there is no more fire in the combustion pot and the blowers are off. In all other cases, see CSA B365 standard.

Note 1 : Recommended heating area and maximum burn time may vary subject to location in home, chimney draft, heat loss factors, climate, fuel type, feed rate, fuel level, and other variables. The recommended heated area for a given appliance is defined by the manufacturer as its capacity to maintain a minimum acceptable temperature considering that the space configuration and the presence of heat distribution systems have a significant impact in making heat circulation optimum.

Note 2 : May vary depending on pellet size and/or density.

Note 3 : Fresh air intake kit required.

*Technical data contained in this brochure are for reference only. Any installation must be done according to the data and drawings detailed in the owner's manual.*

# OSBURN LIMITED LIFETIME WARRANTY

on SCHOTT ROBAX® Ceramic Glass

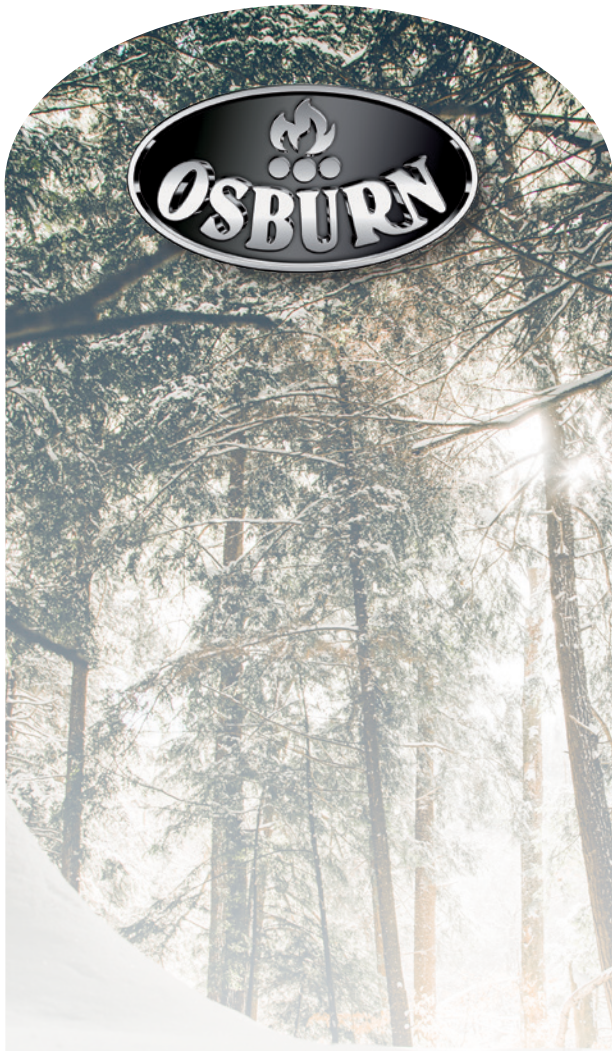

**SCHOTT  
ROBAX®**

SCHOTT ROBAX® glass-ceramic panels combine high quality, thermal resistance, and one-of-a-kind material properties to offers pure fireside pleasure with an unobstructed and safe view of the fire. 95% made of quartz sand and two other natural raw materials, SCHOTT ROBAX® glass-ceramic panels boast extremely low thermal expansion. These panels are especially heat resistant and can withstand blazing short-term temperatures, as well as substantial temperature fluctuations and thermal shocks. Given their high IR transmission values, SCHOTT ROBAX® glass-ceramic panels also allow for the heat produced inside the fire-box to be more efficiently transferred through the glass.

As the quality of the components of our appliances is a priority at Osburn, we have chosen the SCHOTT ROBAX® solution for our appliances and offer a limited lifetime warranty on ceramic glass.

**FOR MORE DETAILS ON OUR PRODUCT WARRANTY:  
[osburn-mfg.com/en/warranty](http://osburn-mfg.com/en/warranty)**



# WOOD:

## A CARBON NEUTRAL SOURCE OF HEATING

When oil, gas, and coal are burned, the carbon they contain is oxidized to carbon dioxide (CO<sub>2</sub>), the main greenhouse gas. The combustion of fossil fuels releases ancient carbon, thereby increasing the atmospheric concentration of carbon dioxide (CO<sub>2</sub>).

On the other hand, wood combustion can be considered carbon neutral. When trees mature, die, fall in the forest and decompose, the same amount of carbon is emitted as would be released if they were burned for heat. When we heat with wood, we are simply tapping into the natural carbon cycle in which CO<sub>2</sub> flows from the atmosphere to the forest and back. In addition, the wood used for residential heating is an excellent example of sustainable development. It comes from woodlots near households and is cultivated by landowners for whom the health of the woodlot depends on the selective cutting of old trees and collecting of dead wood.

Removing these diseased or dead trees makes room for healthy trees that grow faster. This therefore adds value to the woodland, in addition to helping the environment.

Wood, when burned in an appliance whose performance has been tested to EPA or CSA B415.1-10 standards, emits up to 80% less particles than stoves and fireplaces that do not meet the most recent regulations. It therefore constitutes a clean and renewable alternative energy source. In addition, the consumption of firewood can be reduced by up to 30% when using advanced wood burning systems. This is because EPA or CSA B415.1-10 certified appliances are 60% to 80% efficient, compared to 40% or 60% for traditional stoves and fireplaces.





# MAXIMUM RECOMMENDED HEATING AREA

IN SQUARE FEET BY CLIMATE ZONE

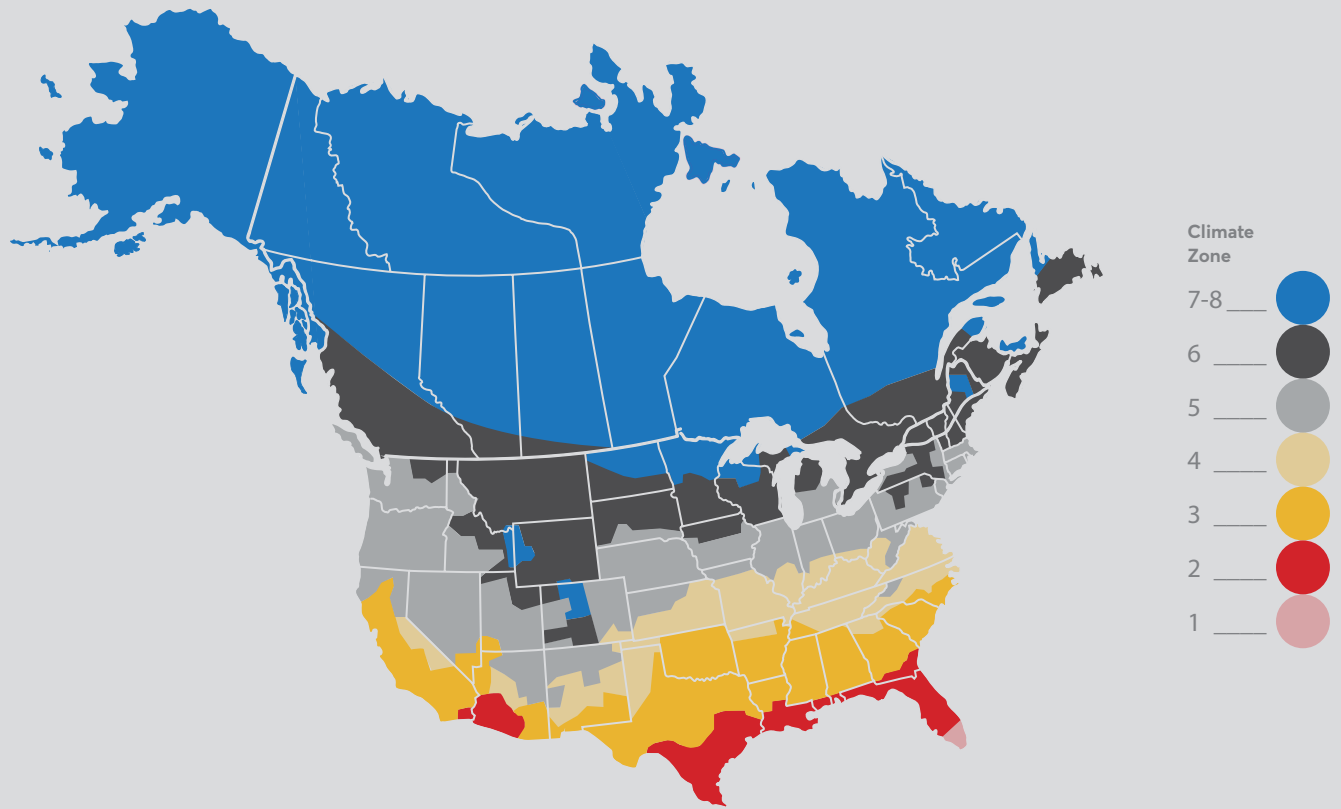

WOOD STOVE MODELS	Zone 1-2	Zone 3	Zone 4	Zone 5	Zone 6	Zone 7-8
950	1,800	1,650	1,500	1,350	1,200	900
1700	2,400	2,250	2,100	1,950	1,800	1,500
2000	2,900	2,700	2,500	2,300	2,100	1,700
Inspire 2000	2,900	2,700	2,500	2,300	2,100	1,700
Matrix	2,900	2,700	2,500	2,300	2,100	1,700
3300	3,100	2,900	2,700	2,500	2,300	1,900
3500	3,500	3,300	3,100	2,900	2,700	2,300
WOOD INSERT MODELS	Zone 1-2	Zone 3	Zone 4	Zone 5	Zone 6	Zone 7-8
Matrix 1900	1,800	1,650	1,500	1,350	1,200	900
1700	2,400	2,250	2,100	1,950	1,800	1,500
2000	2,900	2,700	2,500	2,300	2,100	1,700
Matrix	2,900	2,700	2,500	2,300	2,100	1,700
Inspire 2000	2,900	2,700	2,500	2,300	2,100	1,700
Matrix 2700	3,000	2,800	2,600	2,400	2,200	1,800
3500	3,500	3,300	3,100	2,900	2,700	2,300
FIREPLACE MODELS	Zone 1-2	Zone 3	Zone 4	Zone 5	Zone 6	Zone 7-8
Stratford II	3,000	2,800	2,600	2,400	2,200	1,800
Everest II	3,300	3,100	2,900	2,700	2,500	2,100
Horizon	3,600	3,400	3,200	3,000	2,800	2,400
PELLET STOVE MODEL	Zone 1-2	Zone 3	Zone 4	Zone 5	Zone 6	Zone 7-8
2500	2,800	2,600	2,400	2,200	2,000	1,600

## ACCESSORIES

### FIREPLACE TOOL SETS



CODE: #AC02620

#### DUPLEX

Contains four instruments: poker, broom, shovel and scraper. The clean lines and combination of steel and wood construction make a strong contemporary design statement.

Height of accessories:  
27 1/4" (69 cm)



CODE: #AC02621

#### INEO

Contains four instruments: poker, broom, shovel and scraper. The fine narrow lines and simplicity make a strong contemporary design statement.

Height of accessories:  
28 5/8" (72 cm)



CODE: #AC02622

#### PAPYRUS

Contains four instruments: poker, broom, shovel and clamp – all the tools needed to operate and maintain your wood-burning stove or fireplace. The dramatic use of steel makes a strong contemporary design statement.

Height of accessories:  
27 1/2" (70 cm)  
Base diameter:  
7 1/2" (19 cm)



CODE: #AC02350

#### EQUISS

Made of high quality steel. Its integrated handles make handling easier. Two identical parts that intersect easily. Assembly and disassembly in seconds for compact storage.

Height: 15 1/4" (38 cm)  
Length: 24 1/4" (61 cm)  
Depth: 13" (33 cm)



CODE: #AC02627

#### FUSIO

This distinctive log holder combines steel and cherrywood; its curved shape makes a strong contemporary design statement. Make your life simpler by fueling your fire without ever being caught unprepared.

Height: 20" (51 cm)  
Length: 18 1/2" (47 cm)  
Depth: 24" (61 cm)



CODE: #AC02628

#### NORDIK

Contains four accessories: poker, broom, shovel and tongs. Its wooden base and steel structure gives it an industrial look, perfect for contemporary or rustic spaces.

Support height:  
21 7/8" (53 cm)  
Length:  
9 1/2" (24 cm)  
Depth:  
4 3/4" (12 cm)



CODE: #AC02629

#### PETALE

Contains four accessories: poker, broom, shovel and tongs. A nice option for those who want to camouflage tools for a more decorative look.

Height:  
20" (51 cm)  
Diameter:  
7 1/2" (19 cm)



CODE: #AC02631

#### SPEKTRA

Contains four accessories: poker, broom, shovel and tongs. You will appreciate its futuristic look for a unique atmosphere.

Height:  
20" (51 cm)  
Diameter:  
7 1/2" (19 cm)

# ACCESSORIES

## OPTIONS



### GLASS HEARTH PAD PROTECTION

This light-colored tempered glass hearth pad is particularly resistant to shocks. This glass plate is a safe and durable choice for your fireplace and will add elegance to your decor. Its manufacture is precise and neat: polished edges and non-cutting corners.

Four sizes:

- 54" x 46 3/4" (AC02703)
- 44" x 36" (AC02704)
- 50" x 18" (AC02760)
- 70" x 20" (AC02761)

Thickness: 10 mm



### TINTED TEMPERED GLASS HEARTH PAD

Two sizes:

- 54" x 46 3/4" (AC02758)
- 44" x 36" (AC02757)

Thickness: 10 mm



### CERTIFIED MODULAR HEAT SHIELD

A simple, attractive, and safe solution to effectively reduce wall clearances, and ensure maximum protection of the floor. Easy assembly, the modular system will blend in with any room decor. Powder coated steel panels offering superior durability and quality.



### NON-COMBUSTIBLE MANTELS

Incredibly realistic wood-like detailing.  
Two shades: washed cedar and tavern brown.  
Two lengths: 60" and 72"  
Height: 8"  
Depth: 8"

- 60" washed cedar (AC02780)
- 72" washed cedar (AC02781)
- 60" tavern brown (AC02782)
- 72" tavern brown (AC02783)

\*Check local codes for approved alternatives. Any installation must be done according to the data and drawings detailed in the owner's manual.

# WHY choose



## HIGH DENSITY INSULATION baffle

- Space shuttle **QUALITY**
- Resistant up to **2800°F**

## RUGGED steel

- **5/16"** top thickness
- **EXTENDED HEAT** radiation

## CERAMIC glass

- **ALL AROUND** solid glass  
retainer system
- **LIFETIME WARRANTY**  
even on accidental breakage

## HIGH DENSITY firebricks

- Impact **RESISTANT**
- Superior **HEAT RELEASING**  
capabilities

MADE IN CANADA  
NORTH AMERICAN STEEL



PUB047A



7 73388 99521 2