



NQ512BR NQ512BG NQ512BB NQ512BW

## DIGITAL MEDIA RECEIVER



# CONTENTS

Warnings&Precautions .....	1 EN
FCC Statement .....	1 EN
ISED Statement .....	2 EN
Product Features .....	2 EN
Accessory List .....	3 EN
Dimension(Unit:mm) .....	3 EN
Wiring Diagram .....	4 EN
Basic Functions Of Panel Keys .....	5 EN
Remote Operation .....	6 EN
Basic Operation .....	6 EN
Radio Operation .....	7 EN
Start Listening .....	7 EN
USB Playback .....	7 EN
AUX Input .....	7 EN
Bluetooth Operation .....	8 EN
Bluetooth Pairing .....	8 EN
Bluetooth Basic Operation .....	8 EN
Bluetooth Music Operation .....	8 EN
APP Operation .....	9 EN
APP Download .....	9 EN
APP Connection .....	9 EN
APP Operation .....	10 EN
External Microphone .....	10 EN
Audio Settings .....	11 EN
Audio Settings List .....	11 EN
Preset EQ Select .....	11 EN
User EQ Setup .....	11 EN
Loundness Setup .....	11 EN
Bass Adjustment .....	11 EN
Treble Adjustment .....	11 EN
Balance Adjustment .....	11 EN
Fader Adjustment .....	11 EN
Audio Setup Reset .....	11 EN
Tuner Settings .....	12 EN
Tunner Settings List .....	12 EN
Stereo/Mono Select .....	12 EN
DX/Local Select .....	12 EN
RDS ON/OFF .....	12 EN
Tuner Area Select .....	12 EN
Clock And Date Settings .....	13 EN
Clock And Date Settings List .....	13 EN
Clock Format Settings .....	13 EN
Clock Adjust .....	13 EN
Display Settings .....	13 EN
Display Settings List .....	13 EN
Spectrum On/Off .....	13 EN
ID3 On/Off .....	13 EN
System Version .....	13 EN
Trouble Shooting .....	14 EN
Speaker Connection .....	14 EN
Specification .....	15 EN

## WARNINGS & PRECAUTIONS

---

To avoid risk of serious injury or possible violation of laws, please read the following thoroughly before installation or connecting.

- This product is designed specifically for use with 12 volt, negative ground electrical systems only.
- Having the wiring and installation done by expert.  
Be sure to disconnect the cable from the negative battery terminal while installation.
- This apparatus shall not be exposed to dripping or splashing, and no object filled with liquids, shall be placed on the apparatus.
- Fuses shall be replaced only with the correct type and fuse value, and only when the apparatus is powered off.
- To prevent a short circuit, never put or leave any metallic objects (such as coins or metallic tools) inside the unit.
- Never set the volume of this product so high that you cannot hear outside traffic and emergency vehicles.

## FCC STATEMENT

---

This equipment has been tested and found to comply with the limits for a Class B digital device, pursuant to part 15 of the FCC Rules. These limits are designed to provide reasonable protection against harmful interference in a residential installation. This equipment generates, uses and can radiate radio frequency energy and, if not installed and used in accordance with the instructions, may cause harmful interference to radio communications. However, there is no guarantee that interference will not occur in a particular installation. If this equipment does cause harmful interference to radio or television reception, which can be determined by turning the equipment off and on, the user is encouraged to try to correct the interference by one or more of the following measures:

- Reorient or relocate the receiving antenna.
- Increase the separation between the equipment and receiver.
- Connect the equipment into an outlet on a circuit different from that to which the receiver is connected.
- Consult the dealer or an experienced radio/TV technician for help.

**Caution:** Any changes or modifications to this device not explicitly approved by manufacturer could void your authority to operate this equipment.

This device complies with part 15 of the FCC Rules. Operation is subject to the following two conditions:

1. This device may not cause harmful interference.
2. This device must accept any interference received, including interference that may cause undesired operation.

### RF Exposure Information

This equipment complies with FCC radiation exposure limits set forth for an uncontrolled environment. This equipment should be installed and operated with minimum distance 20cm between the radiator and your body.

## ISED STATEMENT

---

**English:** This device contains licence-exempt transmitter(s)/receiver(s) that comply with Innovation, Science and Economic Development Canada's licence-exempt RSS(s). Operation is subject to the following two conditions:

1. This device may not cause interference.
2. Cause undesired operation of the device.

The digital apparatus complies with Canadian CAN ICES-3 (B)/NMB-3(B).

**French:** Cet appareil contient des émetteurs/récepteurs exempts de licence qui sont conformes aux RSS exemptés de licence d'Innovation, Sciences et Développement économique Canada. L'exploitation est soumise aux deux conditions suivantes :

1. Cet appareil ne doit pas provoquer d'interférences.
2. Cet appareil doit accepter toute interférence, y compris les interférences susceptibles de provoquer un fonctionnement indésirable de l'appareil.

l'appareil numérique du ciem conforme canadien peut - 3 (b) / nmb - 3 (b).

This device meets the exemption from the routine evaluation limits in section 2.5 of RSS 102 and compliance with RSS 102 RF exposure, users can obtain Canadian information on RF exposure and compliance.

Cet appareil est conforme à l'exemption des limites d'évaluation courante dans la section 2.5 du cnr - 102 et conformité avec rss 102 de l'exposition aux rf, les utilisateurs peuvent obtenir des données canadiennes sur l'exposition aux champs rf et la conformité.

This equipment complies with Canada radiation exposure limits set forth for an uncontrolled environment.

Cet équipement est conforme aux limites d'exposition aux rayonnements du Canada établies pour un environnement non contrôlé.

This equipment should be installed and operated with minimum distance 20cm between the radiator & your body.

Cet équipement doit être installé et utilisé à une distance minimale de 20 cm entre le radiateur et votre corps.

## PRODUCT FEATURES

---

**LCD:** VA-LCD DISPLAY

**Bluetooth:** Version 5.1

**Bluetooth Music:** Support

**Push to Talk:** Support

**EQ:** 32 band, 8 Preset

**Pre-Output:** 4CH x 2V

**Max Power:** 4 x 50W

**Radio:** Preset 18FM, 12AM, RDS

**APP Control:** iOS and Android Phone

**Charge:** Front USB 1A

**Audio Format:** MP3, WMA, AAC, FLAC

## ACCESSORY LIST

Please check the following accessories after opening the package:

ISO Male Connector x2

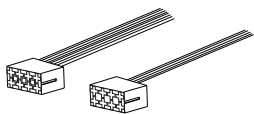

Remote x1



Battery (Not Included)

Disassemble keys x2

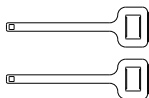

User Manual x1



## DIMENSION(UNIT:MM)

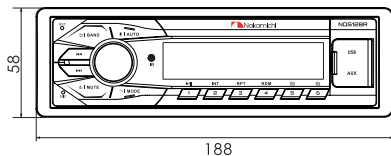
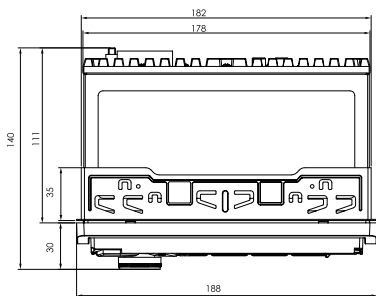
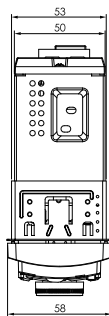

# WIRING DIAGRAM

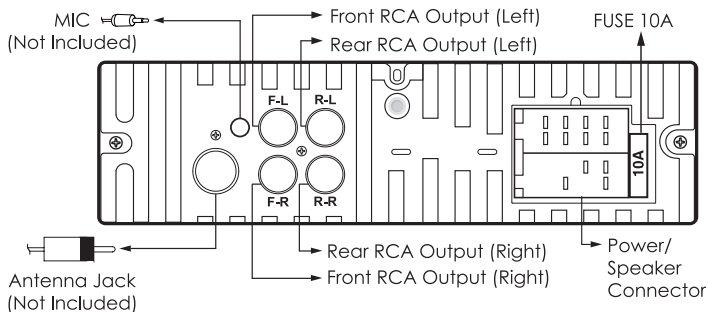

## POWER/SPEAKER CONNECTOR

Color	Name
Red	Ignition Wire
Black	GND
Blue	Amplifier Control
Yellow	Battery(+)
Green/Black	Rear Left Speaker -
Green	Rear Left Speaker +
White/Black	Front Left Speaker -
White	Front Left Speaker +
Gray/Black	Front Right Speaker -
Gray	Front Right Speaker +
Purple/Black	Rear Right Speaker -
Purple	Rear Right Speaker +

## BASIC FUNCTIONS OF PANEL KEYS

To	Radio Status	USB/BT Music Status
⏪ ⏩	Seek a station manually	Previous/Next track
1	Preset 1	Playback/Pause
2	Preset 2	Intro Playback
3	Preset 3	Repeat Playback
4	Preset 4	Random Playback
5 6	Preset 5/Preset 6	Previous/Next folder
⏪   BAND	Return key function in menu state In radio mode, press to toggle FM1/FM2/FM3/AM1/AM2	
🔇   MUTE	Press to mute, Press an hold to shutdown In call mode, press to end call	
🎤   AUTO	Short press to voice key (bluetooth connection required) In radio mode, press to radio to auto search the channel	
📞   MODE	When the call comes, short press to answer the call (bluetooth connection required) In call mode, short press to switch sound channel (car horn or handset) Short press to switch mode function	

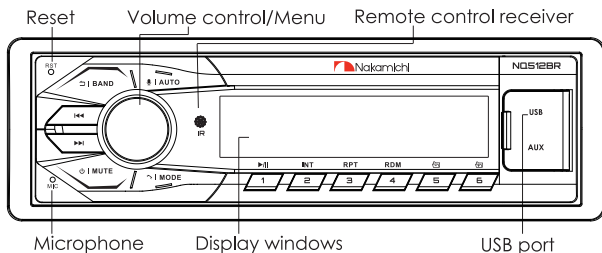



# REMOTE OPERATION

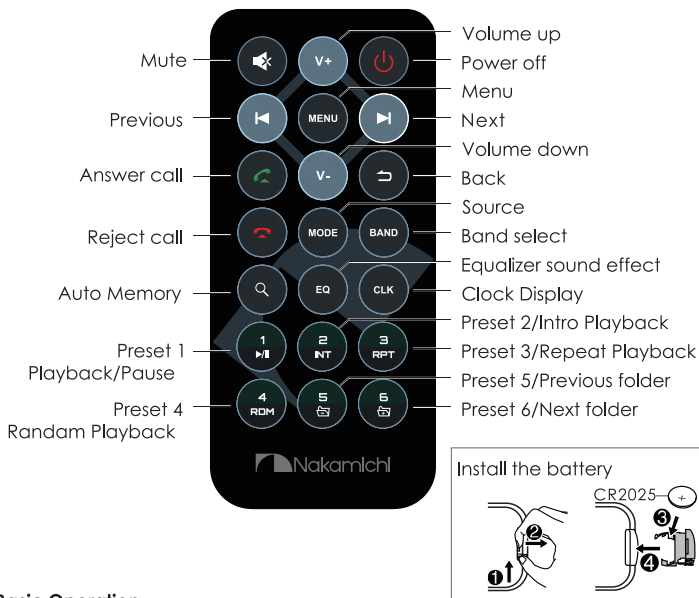

## Basic Operation

To	Operation (panel)
Power on	Press <b>⏻</b>   <b>MUTE</b>
Power off	Press and hold <b>⏻</b>   <b>MUTE</b>
Mute	Press <b>⏻</b>   <b>MUTE</b>
Volume up and down	Turn the knob
Source select	Press <b>↶</b>   <b>MODE</b>
Menu	Press the knob
Return	Press <b>↷</b>   <b>BAND</b> (In menu status)
Turn on voice	Press <b>🗣️</b>   <b>AUTO</b> (Bluetooth is connected)

## RADIO OPERATION

### Start Listening

To	Operation (panel)	Remark
Auto memory	Press and hold <b>1</b> <b>AUTO</b>	18 FM/12AM
Band selection	Press <b>2</b> <b>BAND</b>	FM1/FM2/FM3/AM1/AM2
Seek a station manually	Press <b>3</b> <b>4</b>	
Search the next or previous frequency step by step	Press and hold <b>3</b> <b>4</b>	
Store a station	Press and hold 1-6	

## USB PLAYBACK

To	Operation (panel)
Track selection	Press <b>5</b> <b>6</b>
Fast playback	Press and hold <b>5</b> <b>6</b>
Playback/Pause	Press <b>1</b>
Track pre-play	Press <b>2</b>
Repeat playback	Press <b>3</b> <ul style="list-style-type: none"><li>• REPEAT ONE.REPEAT DIR.REPEAT ALL</li></ul>
Random playback	Press <b>4</b> <ul style="list-style-type: none"><li>• ON/OFF</li></ul>
Folder selection	Press <b>5</b> <b>6</b>

## AUX INPUT

- 1.Connect a portable audio player(commmercially available).  
Auxiliary input jack

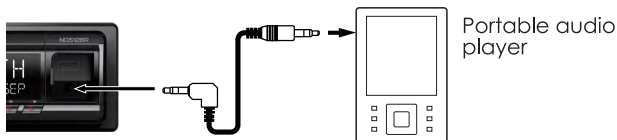

Auxiliary input jack

3.5mm stereo mini plug with "L" shaped connector.  
(commercially available).

- 2.Press[ **2** **MODE** ]buttons to select AUX IN.
- 3.Turn on the portable audio player and start playback.

# BLUETOOTH OPERATION

## Bluetooth Pairing

The first time pair mobile phone with receiver, please follow below steps:

1. When there is no pairing, in any mode, the BT1 on the LCD will flash, and the pairing can be performed at this time.
2. Turn on the phone's Bluetooth to Search NQ512B.
3. Click on the NQ512B on the phone to connect. After the connection is successful, the BT1 will stop flashing.
4. When pairing is complete, the mobile phone audio will automatically transfer to the car audio system whenever a call is made or received, or when the mobile phone plays music.

### Note:

For more details of bluetooth pairing, please refer to the owner's manual for your mobile phone.

## Bluetooth Basic Operation

To	Operation (panel)
Answer a call	Press <b>↶</b>   <b>MODE</b>
Switch the car horn or mobile phone handset	Press <b>↶</b>   <b>MODE</b> (In a call)
End a call	Press <b>⏻</b>   <b>MUTE</b> (In a call)
Adjust call volume	Turn on the knob

## Bluetooth Music Operation

To	Operation (panel)
Previous track	Press <b>⏮</b>
Next track	Press <b>⏭</b>
Playback/Pause	Press <b>1</b>

# APP OPERATION

## APP Download

Please go to the APPALE APP Store or Google Play Store and search [Nakamichi AMC] app, after downloading the APP, install it on your Appale & Android devices.

## APP Connection

1. Open the [Nakamichi AMC] APP, click [🔍] to search for NQ512B.
2. Click NQ512B to connect, the [🔴] will be red after the connect is successful.

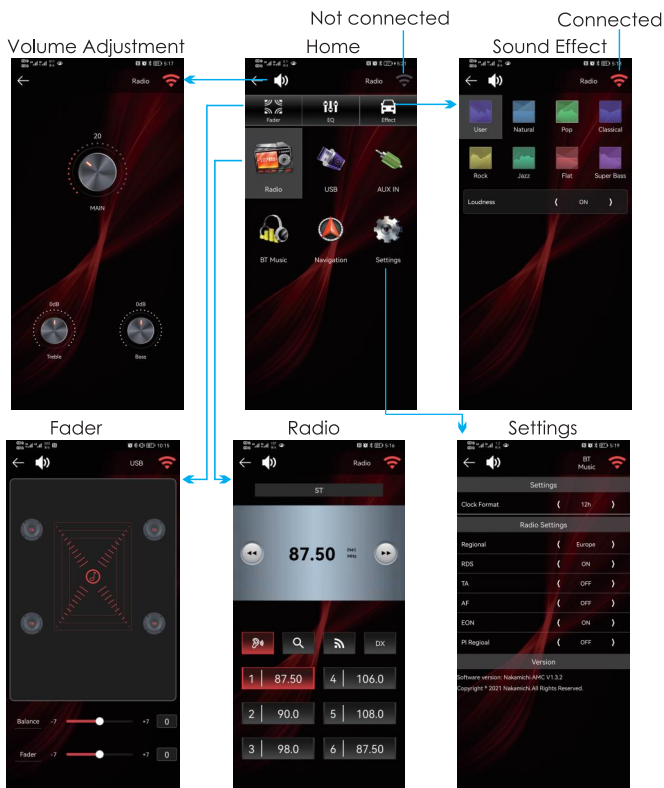

# APP OPERATION

## EQ Settings



## Bluetooth Music Playback

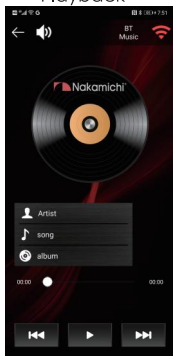

## Home



## USB Playback

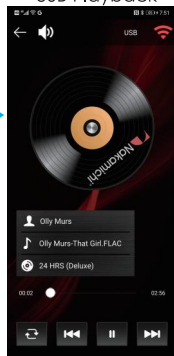

# EXTERNAL MICROPHONE

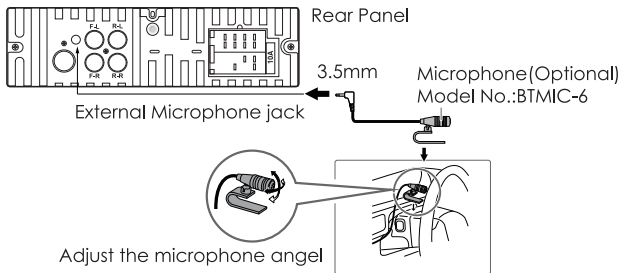

## Note:

Since the panel microphone is far from the driver's position, when using an external microphone, you can get better voice calls.

## AUDIO SETTINGS

- 1.Press the knob to enter the [MENU].
- 2.Turn the knob to select [AUDIO],then press the knob.

### Audio Settings List

Menu	Adjustment
PRESET EQ	USER/NATURAL/POP/CLASS/ROCK/JAZZ/FLAT/SUPER BASS
	└ 30Hz/60Hz/80Hz/100Hz/120Hz/160Hz/250Hz/400Hz/600Hz/ 800Hz/1KHz/1.5KHz/2KHz/2.5KHz/3KHz/3.5K/4K/5K/6K/7K/8K/ 9K/10K/11K /12K/13K/14K/15K/16K/17K/18K/19K
LOUD	OFF/ON
BASS	BASS -7 ~ +7
TREBLE	TREBLE -7 ~ +7
BAL	BALAN L7-L0,0,R1-R7
FADER	FADER R7-R0,0,F1-F7
AUDIO RESET	NO/YES

### Preset EQ Select

- 1.Turn the knob to select [PRESET EQ ],then press the knob.
- 2.Turn the knob to select [USER/NATURAL/POP/CLASS/ROCK/JAZZ/FLAT/SUPER BASS].

### User EQ Setup

- 1.Turn the knob to select [PRESET EQ ],then press the knob.
- 2.Turn the knob to select [USER],then press the knob.
- 3.Turn the knob to select frequency for adjustment.

### Loudness Setup

- 1.Turn the knob to select [LOUD],then press the knob.
- 2.Turn the knob to select [OFF/ON].

### Bass Adjustment

- 1.Turn the knob to select [BASS],then press the knob.
- 2.Turn the knob to adjustment [-7 to +7].

### Treble Adjustment

- 1.Turn the knob to select [TREBLE],then press the knob.
- 2.Turn the knob to select [-7 to +7].

### Balance Adjustment

- 1.Turn the knob to select [BAL],then press the knob.
- 2.Turn the knob to select [ L7-L0 toR1-R7].

### Fader Adjustment

- 1.Turn the knob to select [FADER],then press the knob.
- 2.Turn the knob to select [ R7-R0 toF1-F7].

### Audio Setup Reset

- 1.Turn the knob to select [AUDIO RESET],then press the knob.
- 2.Turn the knob to select [NO/YES].

## TUNER SETTINGS

- 1.Press the knob to enter the [MENU].
- 2.Turn the knob to select [TUNER],then press the knob.

### Tuner Settings List

Menu	Adjustment	
TUNER	STEREO/MONO	NONE/NEWS/AFFAIRS/INFO/SPORT/
	DX/LOCAL	EDUCATE/DRAMA/CULTURE/SCIENCE/
	RDS OFF/ON	VARIED/POP M/ROCK M/EASY M/
	<input type="checkbox"/> TA OFF/ON	LIGHT M/CLASSICS/OTHER M/WEATHER/
	<input type="checkbox"/> AF ON/OFF	FINANCE/CHILDREN/SOCIAL/RELIGION/
	<input type="checkbox"/> EON OFF/ON	PHONE IN/TRAVEL/LEISURE/JAZZ/
	<input type="checkbox"/> REG OFF/ON	COUNTRY/NATION M/OLDIES/FOLK M/
	<input type="checkbox"/> PTY OFF/ON	DOCUMENT
	AREA EUR/USA/ASIA/RUSS	

### Stereo/Mono Select

Turn the knob to select [STEREO or MONO],then turn the knob select [STEREO/MONO].

### DX/Local Select

Turn the knob to select [LOC or DX],then turn the knob select [DX /LOCAL].

Remark: DX:Distant exchange

### RDS ON/OFF

Turn the knob to select [RDS OFF],then turn the knob select [RDS OFF,ON].

### Tuner Area Select

Turn the knob to select [AREA],then turn the knob select [EUR/USA/ASIA/RUSS].

## CLOCK AND DATE SETTINGS

---

- 1.Press the knob to enter the [MENU].
- 2.Turn the knob to select [CLOCK],then press the knob.

### Clock And Date Settings List

Menu	Adjustment
CLK FRMT	12H/24H
CLK ADJ	00:00

### Clock Format Settings

- 1.Turn the knob to select [CLK FRMT],then press the knob.
- 2.Turn the knob to select [12H/24H].

### Clock Adjust

- 1.Turn the knob to select [CLK ADJ],then press the knob.
- 2.Turn the knob to adjustment.
- 3.Press the knob to switch the clock/minute adjustment.

## DISPLAY SETTINGS

---

### Display Settings List

Menu	Adjustment
SPECTRUM	OFF/ON
ID3 TAG	OFF/ON
VERSION	VER 3.1

### Spectrum ON/OFF

- 1.Turn the knob to select [SPECTRUM],then press the knob.
- 2.Turn the knob to select [OFF/ON].

### ID3 ON/OFF

- 1.Turn the knob to select [ID3 TAG],then press the knob.
- 2.Turn the knob to select [OFF/ON].

### System Version

Turn the knob to select [VERSION],then press the button to query the system version information.



## TROUBLE SHOOTING

---

### Not work

Fuse blown

### Remedy

Replace the fuse: small 10A(Red)

### Not responding

System problem

Reset the unit

### Can't turn on voice

Bluetooth is not connected

Phone does not support voice

Connect Bluetooth

N.A

### Not playing

Incorrect device format

Device error

Unsupported audio file

Reformat

Replacement device

Replace supported audio files

### Radio reception is poor

Poor contact of radio antenna

Poor signal at location

Reconnect the radio antenna

Change to other positions

### Remote control is invalid

Remote control battery is low

Replace CR2025 battery

### Bluetooth call is poor

Microphone is too far away

Speak into the microphone

## SPEAKER CONNECTION

---

Do not connect the speaker leads of the power cord to the car battery; otherwise, the unit will be seriously damaged.

Before connecting the speaker leads of the power cord to the speakers, check the speaker wiring in your car.

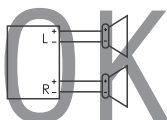
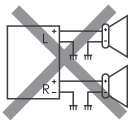
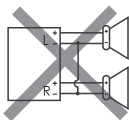

## SPECIFICATION

GENERAL	Power supply Requirement	DC 12V
	Maximum power output	50W X 4CH
	Speaker impedance	4 - 8 Ohm
	Unit Dimensions(WxHxD)	178 X 111 X 50 mm
	Weight	0.4 kg
	Fuse	10 A

RADIO	FM Frequency Range	87.5MHz-108.0MHz
	AM Frequency Range	522 KHz~1620 KHz
	Preset	18FM, 12AM

USB Index	Usable Audio Formats:	MP3/WMA
	USB Port Type:	2.0
	USB Maximum Capacity:	64GB
	USB Charging:	5V/1A
	Frequency Response:	20 Hz - 20 KHz
	S/N Ratio:	60 dB

BLUETOOTH	Version	Bluetooth 5.1
	BT Profile supports:	A2DP, AVRCP, HFP
	Range of frequency:	2.4 GHz spectrum





CONNECT WITH US ONLINE TO EXPLORE NAKAMICHI'S COMPLETE RANGE,  
INSTRUCTIONS & SOFTWARE DOWNLOADS AND WARRANTY REGISTRATION.

[WWW.NAKAMICHICARAUDIO.COM](http://WWW.NAKAMICHICARAUDIO.COM)

 [nakamichi.global](https://www.facebook.com/nakamichi.global)  [nakamichi.caraudio](https://www.instagram.com/nakamichi.caraudio)

Nakamichi Corp, Japan      Made in China | 中國製造