



# NA3625-W6

## User Manual



# AV MEDIA RECEIVER



## **WARNINGS & PRECAUTIONS**

---

To avoid risk of serious injury or possible violation of laws, please read the following thoroughly before installation or connecting.

- This product is designed specifically for use with 12 volt, negative- ground electrical systems only.
- Having the wiring and installation done by expert.
- Be sure to disconnect the cable from the negative battery terminal while installation.
- This apparatus shall not be exposed to dripping or splashing, and no object filled with liquids, shall be placed on the apparatus.
- Fuses shall be replaced only with the correct type and fuse value, and only when the apparatus is powered off.
- To protect the monitor from damage, do not operate the monitor using a ball point pen or similar tool with a sharp tip.
- To prevent a short circuit, never put or leave any metallic objects (such as coins or metallic tools) inside the unit.
- Never set the volume of this product so high that you cannot hear outside traffic and emergency vehicles.
- Be sure to connect "Parking Break" lead so that the driver can not watch the vehicle is stopped. Failure to do so may result in traffic accident or violation of laws.

## FCC STATEMENT

---

This equipment has been tested and found to comply with the limits for a Class B digital device, pursuant to part 15 of the FCC Rules. These limits are designed to provide reasonable protection against harmful interference in a residential installation. This equipment generates, uses and can radiate radio frequency energy and, if not installed and used in accordance with the instructions, may cause harmful interference to radio communications. However, there is no guarantee that interference will not occur in a particular installation. If this equipment does cause harmful interference to radio or television reception, which can be determined by turning the equipment off and on, the user is encouraged to try to correct the interference by one or more of the following measures:

- Reorient or relocate the receiving antenna.
- Increase the separation between the equipment and receiver.
- Connect the equipment into an outlet on a circuit different from that to which the receiver is connected.
- Consult the dealer or an experienced radio/TV technician for help.

Caution: Any changes or modifications to this device not explicitly approved by manufacturer could void your authority to operate this equipment.

This device complies with part 15 of the FCC Rules. Operation is subject to the following two conditions: (1) This device may not cause harmful interference, and (2) this device must accept any interference received, including interference that may cause undesired operation.

### RF Exposure Information

This equipment complies with FCC radiation exposure limits set forth for an uncontrolled environment. This equipment should be installed and operated with minimum distance 20cm between the radiator and your body.

## ISED STATEMENT

---

English: This device contains licence-exempt transmitter(s)/receiver(s) that comply with Innovation, Science and Economic Development Canada's licence-exempt RSS(s).

Operation is subject to the following two conditions:

- (1) This device may not cause interference.
- (2) This device must accept any interference, including interference that may cause undesired operation of the device.

The digital apparatus complies with Canadian CAN ICES-3 (B)/NMB-3(B).

French: Cet appareil contient des émetteurs/récepteurs exempts de licence qui sont conformes aux RSS exemptés de licence d'Innovation, Sciences et Développement économique Canada.

L'exploitation est soumise aux deux conditions suivantes :

- (1) Cet appareil ne doit pas provoquer d'interférences.
- (2) Cet appareil doit accepter toute interférence, y compris les interférences susceptibles de provoquer un fonctionnement indésirable de l'appareil.

l'appareil numérique du ciem conforme canadien peut - 3 (b) / nmb - 3 (b).

This device meets the exemption from the routine evaluation limits in section 2.5 of RSS 102 and compliance with RSS 102 RF exposure, users can obtain Canadian information on RF exposure and compliance.

Cet appareil est conforme à l'exemption des limites d'évaluation courante dans la section 2.5 du cnr - 102 et conformité avec rss 102 de l'exposition aux rf, les utilisateurs peuvent obtenir des données canadiennes sur l'exposition aux champs rf et la conformité.

This equipment complies with Canada radiation exposure limits set forth for an uncontrolled environment.

Cet équipement est conforme aux limites d'exposition aux rayonnements du Canada établies pour un environnement non contrôlé.

This equipment should be installed and operated with minimum distance 20cm between the radiator & your body.

Cet équipement doit être installé et utilisé à une distance minimale de 20 cm entre le radiateur et votre corps.

# CONTENTS

---

<b>Product Feature</b> .....	<b>1EN</b>
<b>Accessory List</b> .....	<b>2EN</b>
<b>Panel Operation</b> .....	<b>3EN</b>
<b>Wiring Connection</b> .....	<b>4EN</b>
<b>Remote Control Operation</b> .....	<b>5EN</b>
<b>Main Menu</b> .....	<b>6EN</b>
<b>Apple Carplay Operation</b> .....	<b>8EN</b>
<b>Android Auto Operation</b> .....	<b>9EN</b>
<b>Radio Operation</b> .....	<b>10EN</b>
Radio Interface .....	10EN
Radio Area Selection.....	10EN
Automatic Search.....	10EN
RDS Function.....	10EN
<b>Bluetooth Operation</b> .....	<b>11EN</b>
Bluetooth Pairing.....	11EN
Call Interface.....	11EN
Calling record.....	11EN
Phone Book.....	11EN
BT Setup.....	11EN
<b>Multimedia Operation</b> .....	<b>12EN</b>
Music Playback.....	12EN
Video Playback.....	12EN
Bluetooth Music Playback.....	12EN
<b>DSP Operation</b> .....	<b>13EN</b>
Surround Settings(Time Alignment) .....	13EN
Balance Setting.....	14EN
EQ Settings.....	14EN
Filter Settings.....	14EN
<b>General Settings</b> .....	<b>15EN</b>
Language Settings.....	15EN
Microphone Settings.....	15EN
Steering Wheel Learning.....	15EN
Key Lighting Setting.....	15EN
<b>Sound Settings</b> .....	<b>16EN</b>
Reverse Volume Adjustment.....	16EN
Subwoofer Setting.....	16EN
Volume Control Setting.....	16EN
<b>Clock/Calendar Settings</b> .....	<b>17EN</b>
<b>Custom Wallpaper</b> .....	<b>17EN</b>
<b>Common Trouble-shooting</b> .....	<b>18EN</b>
<b>Precations On Power Supply And Speaker Connections</b> .....	<b>18EN</b>
<b>Specifications</b> .....	<b>19EN</b>

## PRODUCT FEATURES

---

- 2-Din receiver with capacitive screen
- Support Carplay™
- Support Android Auto™
- 6.8-inch high-brightness and wide angle screen
- Support Dual USB
- Support reversing camera input
- Support Multi-Color key backlight
- Built-in Bluetooth
- Support Bluetooth music playback
- Built-in 10 band EQ
- Support lossless music
- Support 1080P video playback
- Support MP3/WMA/AAC/FLAC audio playback
- Support H264/WMV/FLV video playback
- 2 Video output
- 4V Front and Rear Pre-output
- 4V Subwoofer output
- 1 Video input
- Support subwoofer output
- Support subwoofer volume control
- Built-in SWI jack
- Maximum power:50W×4
- Support external microphone
- High sensitivity FM/AM, support RDS Presets 18 FM,12AM
- Support steering wheel button learning
- Custom wallpaper
- Includes IR Remote Control

# ACCESSORY LIST

Please check the following accessories after opening the package

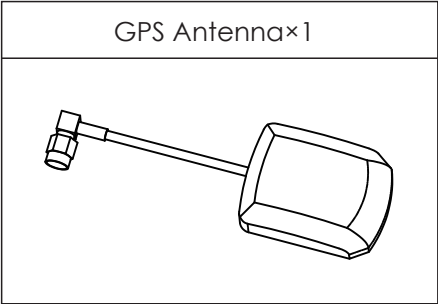
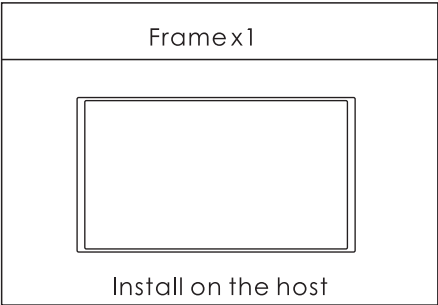
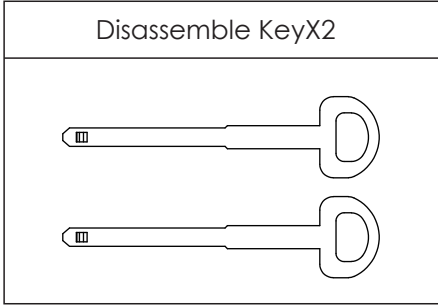
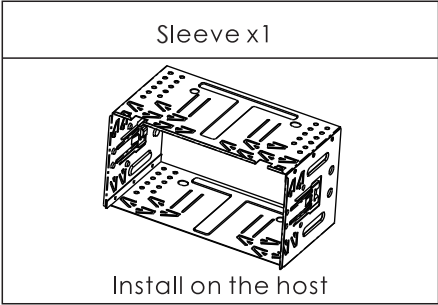
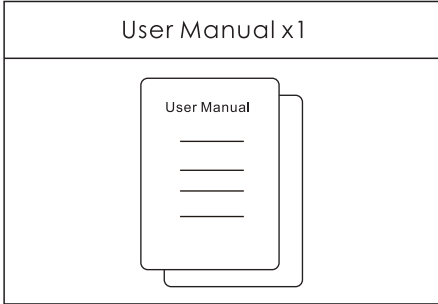
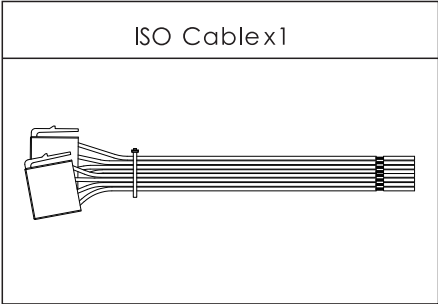



# PANEL OPERATION

---

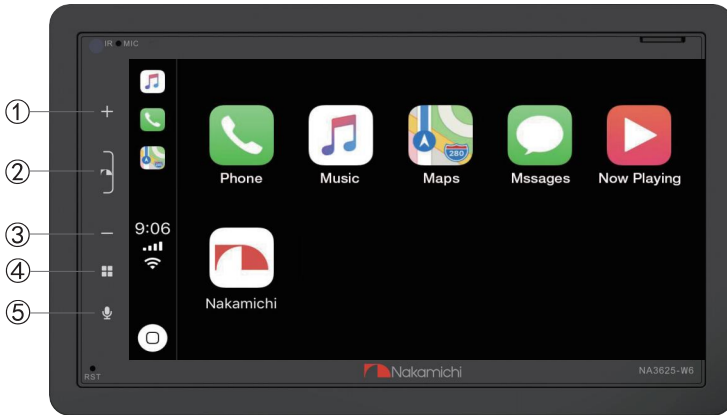

<u>FUNCTION</u>	<u>OPERATIONS &amp; CONTROLS</u>
-----------------	----------------------------------

- |             |   |
|-------------|---|
| 1. Volume + | Short press to increase volume. long press to increase volume continuously. |
| 2. Power    | Short press to mute or unmute. Long press to power off/on.                  |
| 3. Volume - | Short press to decrease volume. long press to decrease volume continuously. |
| 4. MENU     | Press to enter main menu.   |
| 5. VOICE    | Can read your voice, also can instruct your unit.                           |

# WIRING CONNECTION

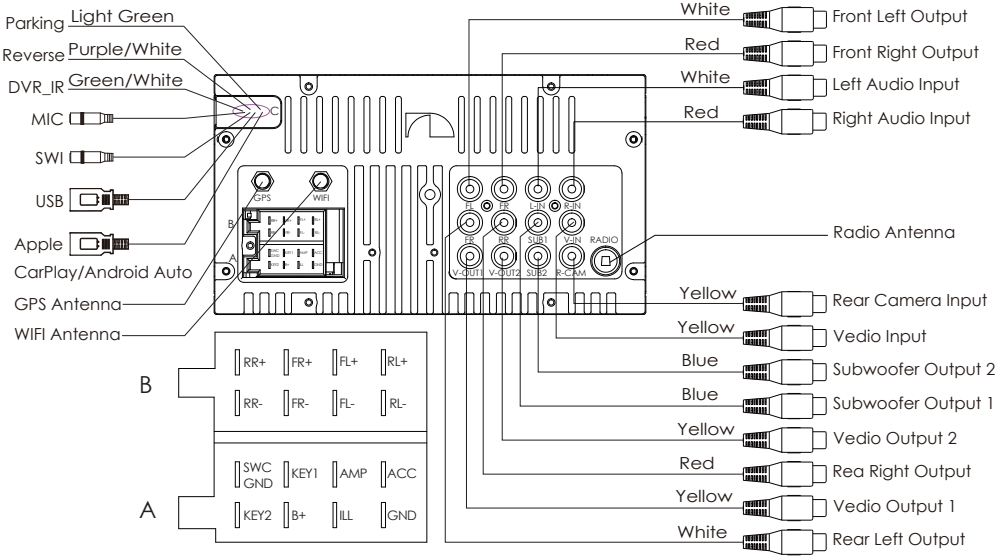

A:Power		
Label	Color	Name
KEY 2	Brown/Black	KEY 2
SWC GND	Black	SWC GND
B+	Yellow	BATTERY
KEY1	Brown	KEY1
ILL	Orange	Illumination
AMP	Blue	Power antenna
GND	Black	GROUND
ACC	Red	Ignition

B:Power		
Label	Color	Name
RR-	Purple/Black	Rear Right Speaker-
RR+	Purple	Rear Right Speaker+
FR-	Grey/Black	Front Right Speaker-
FR+	Grey	Front Right Speaker+
FL-	White/Black	Front Left Speaker-
FL+	White	Front Left Speaker+
RL-	Green/Black	Rear Left Speaker-
RL+	Green	Rear Left Speaker+

## NOTE:

GPS antenna is used to assist navigation when using navigation function in Apple CarPlay/Android Auto.

Wifi antenna is for wireless Apple CarPlay/Android Auto connection.

# REMOTE CONTROL OPERATION

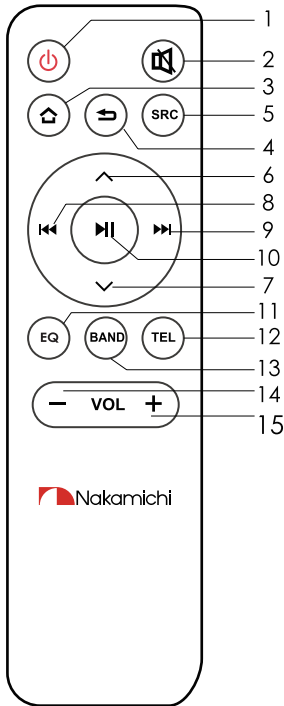

## NO. SYMBOL OPERATION & CONTROL MODES

NO.	SYMBOL	OPERATION & CONTROL MODES
1		Power On/ Off
2		Mute/ Unmute
3		Return to home page
4		Return to the last interface
5	<b>SRC</b>	Switch the source module
6		Radio - Manual tuning (forward)
7		Radio - Manual tuning (reverse)
8		<b>Short Press:</b> Radio - Switch to the previous preset USB/SD or TF/Bluetooth - Previous track
9		<b>Short Press:</b> Radio - Switch to the next preset USB/SD or TF/Bluetooth - next track
10		USB/SD or TF/Bluetooth - Play or Pause
11	<b>EQ</b>	Open/Close loudness.
12	<b>TEL</b>	Bluetooth interface/smart phone. Call back function
13	<b>BAND</b>	Switch between FM and AM bands
14	<b>-</b>	Reduce volume
15	<b>+</b>	Increase volume

### Remark:

Install the battery before using the remote control, Battery model: AAA.

# MAIN MENU

## Language and Region Select

The first time power on, unit will be default into languages setting interface, select the needed country and language, press “√” enter to main menu.

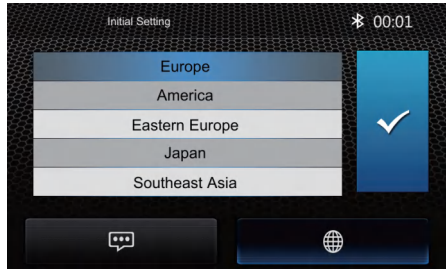
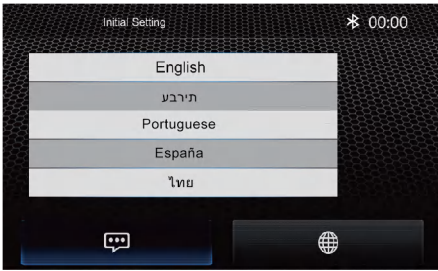

## Main interface operation

NA3625-W6 is a Two Din Car Audio with the following functions:

Apple CarPlay, Google Android Auto, Radio, Bluetooth Audio, USB.

The Mode icon in grey mean the corresponding function is not ready or proper device have not been connected.

Touch the corresponding Mode icon to enter playing mode.

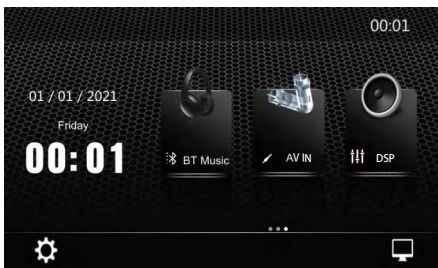
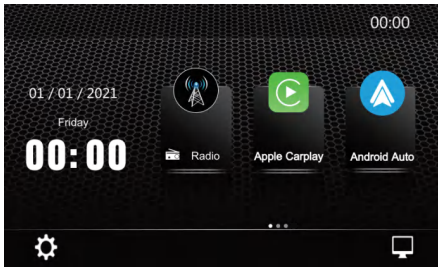

## MAIN MENU

---



Click to enter Radio interface



Click to enter Apple Carplay interface



Click to enter Android Auto interface



Click to enter the USB media interface



Click to enter the SD media interface



Click to enter Bluetooth Phone interface



Click to enter the BT music interface



Click to enter the AV IN input interface



Click to enter DSP adjustment interface



# APPLE CARPLAY

---

Plug the iPhone (iPhone 5 or later models, and iOS 7.1 or above) through the lightning cable to the USB port of the Head unit. The iPhone will be shown the "CarPlay". The Head unit will enter the CarPlay interface, the APP that support the CarPlay feature will be displayed on the Head Unit as shown below. Touch the corresponding APP can operation the operation, touch the  button to go back to the CarPlay interface.



## Siri

In CarPlay mode, user can talk to SIRI to control the CarPlay function. Press  button to start the SIRI function, or touch the  button for 2 seconds or the HOME button of iPhone in the CarPlay Home screen to talk to Siri for playing music, it will go....

Notice: For the Siri function in the Head unit, the Microphone has to be connected.

In CarPlay mode, touch "HOME/Siri" button or  icon to enter the Head unit main menu.

## NOTE:

Wireless Apple CarPlay:

After Bluetooth pairing is successful, the device will prompt to start CarPlay.

Click "Use CarPlay" enter CarPlay function

Click "Not Now" Do not use Carplay

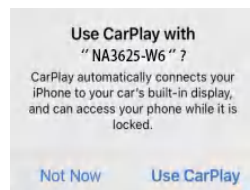

## ANDROID AUTO

---

The NA3625-W6 have the Android Auto function to allow the Android 5.0 or above smartphone display on the Head unit screen.

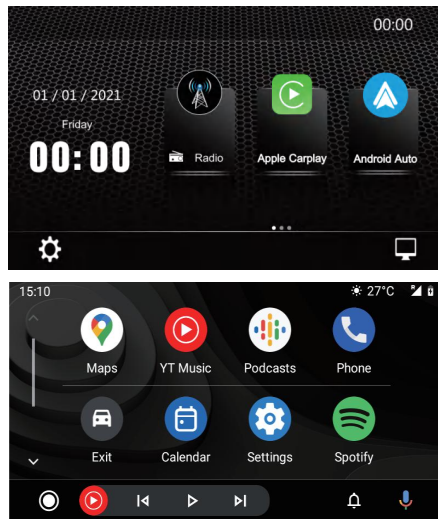

### Install Android auto

User need to install the Android Auto App to the Android phone. When the Android phone first time connected to the NA3625-W6 via USB, the phone will show a website link to download the Android Auto application pack from Google Play. Download and install the apk file on the Android phone. After installed the Android Auto, the Android phone can use the Android Auto function.

### Connection

Connect the Android phone and head unit via USB cable, the Android phone display will be shown on the Head unit screen. User also allows using the touch panel of the head unit to control the Android phone.

# RADIO OPERATION

## Radio Interface



- ◀ Backward
- ▶ Forward
- 📶 Band selection
- ⏮ DPS setting
- 🔍 Automatic search
- 📡 DX/LOC switch
- 📶 Frequency input

## Radio Area Selection

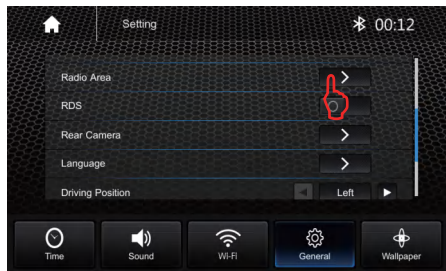

1. Press [ 📶 ] to enter the Homepage.
2. Click [ ⚙️ ] to enter setting interface.
3. Click [ General ] to select [ Radio Area ]
4. Select the corresponding Radio Area.
5. Select the language as the default language according to user needs at the first installation and power-up.

## Automatic Search

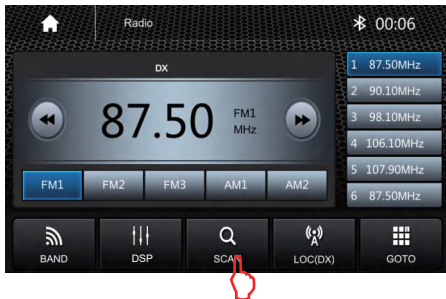

Press and hold the [ Q ] for more than 2 seconds, the radio stations that have been searched will be automatically saved the number list below.

## RDS Function

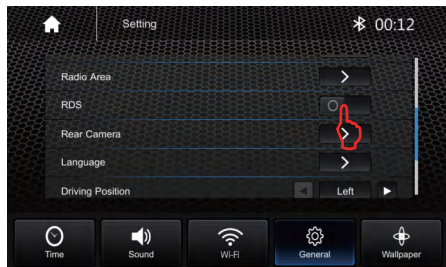

1. Press [ 📶 ] to enter the Homepage.
  2. Click [ ⚙️ ] to enter setting interface.
  3. Click [ General ] to select [ RDS ]
  4. Click RDS to ON:
- Radio RDS ON status:

**SWI** SWI ON:

**SWI** : Closed to a fixed button, please connect the PAC-SWI box to operate the steering wheel buttons.

**SWI** : When SWI is turned on, click the custom square control to enter the steering wheel button learning interface.



# BLUETOOTH OPERATION

## Bluetooth Pairing









The first time pair your mobile phone with AV receiver, please follow below steps:

1. Press [  ] to enter the Homepage.
2. Click [Phone] to enter the Bluetooth interface.
3. Turn on the phone's Bluetooth to search:  
Bluetooth device: NA3625-W6.
4. Click NA3625-W6 to pair.





## Call Interface

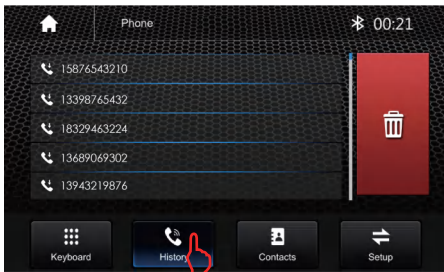

-  Dial
-  Calls record
-  Phone book
-  Setup
-  Answer
-  Backspace

## Calling record



-  Incoming call
-  Called
-  Missed call
-  Delete

## Phone book

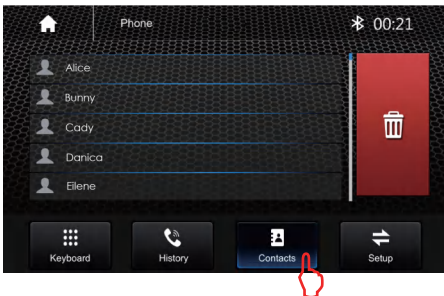

## BT Setup









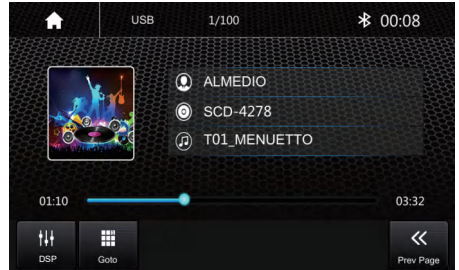



# MULTIMEDIA OPERATION

## Music Playback

1. Press [  ] to enter the Homepage.
2. Click [USB] or [Card] to enter the playback interface.









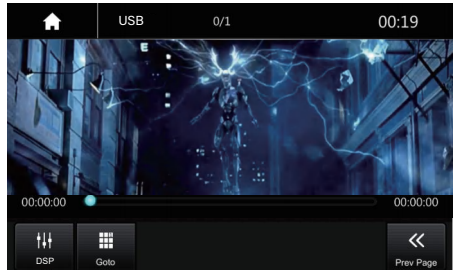
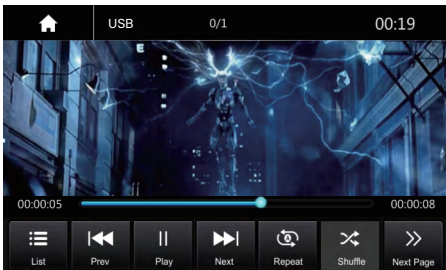



- |   |   |  |  |
|---|---|--|--|
|  Playlist        |  Previous track  |  Play/Pause |  Next track   |
|  Repeat playback |  Random playback |  Next page  |  DSP settings |
|  Play selection  |  Prew page       |  |  |

## Video Playback

1. Click [List] in the USB music interface.
2. Select the video icon to switch to video playback.



- |   |   |   |  |
|---|---|---|--|
|  Playlist         |  Previous track   |  Play/Pause |  Next track    |
|  Repeat playback |  Random playback |  Next page |  DSP settings |
|  Play selection  |  Prew page       |   |  |

## Bluetooth Music Playback

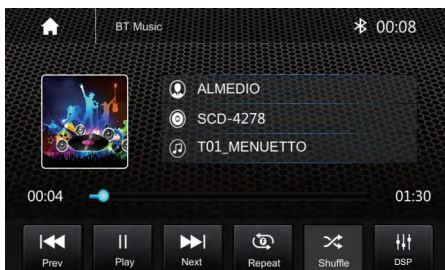

1. Press [  ] to enter the Homepage.
2. Click [ BT MUSIC ] to enter the bluetooth music playback interface.

- |   |
|---|
|  Previous track  |
|  Play/Pause      |
|  Next track      |
|  Repeat playback |
|  Random playback |
|  DSP settings    |

## Surround Settings (Time Alignment)

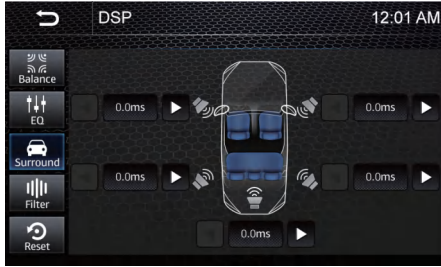

1. Press [  ] to enter the Homepage.
2. Click [DSP] to enter the DSP Settings.
3. Click [Surround] to enter the Surround settings.

Determining the value for <Position> adjustment.

- ① Determine the center of the currently set listening position as the reference point.
- ② The adjustable speaker has five directions: front left, front right, back left, back right, and back.
- ③ The time for the speakers in the five directions to reach the center is the same by default.
- ④ Set the value for each speaker, the delay range: 0-10ms.
- ⑤ Adjust the increase or decrease of each speaker, 0.1 ms each time.

Example: When <back> is selected as the listening position

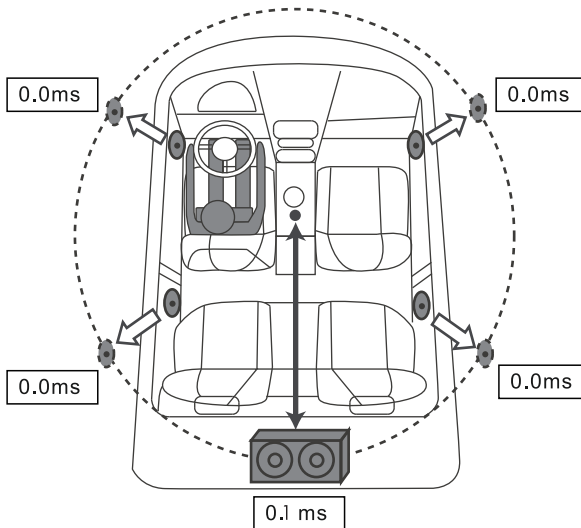

# DSP OPERATION

## Balance Settings

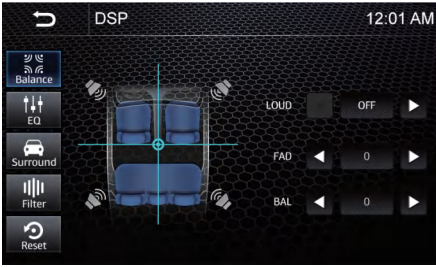

1. Press [  ] to enter the Homepage.
2. Click [DSP] to enter the DSP Settings.
3. Click [Balance] to enter the balance settings.

## EQ Settings

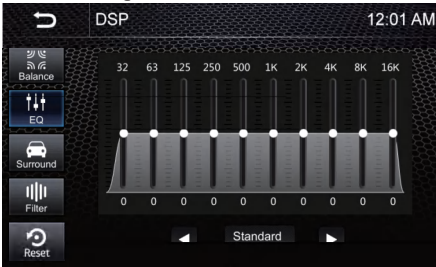

1. Press [  ] to enter the Homepage.
2. Click [DSP] to enter the DSP Settings.
3. Click [ EQ ] to enter the EQ settings.

## Filter Settings

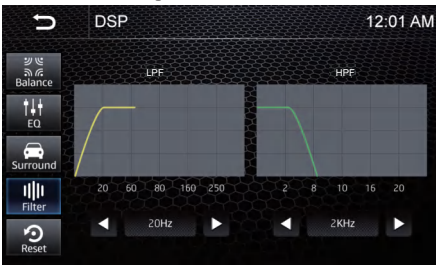

1. Press [  ] to enter the Homepage.
2. Click [DSP] to enter the DSP Settings.
3. Click [Filter] to enter the Filter Settings.

# GENERAL SETTINGS

## Language Settings

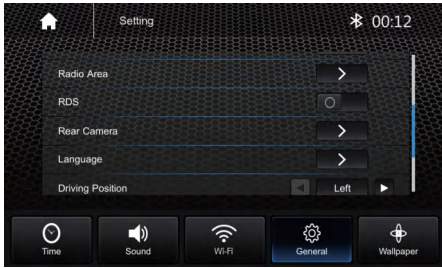

1. Press [ ■ ] to enter the Homepage.
2. Click [ ⚙ ] to enter the setting interface.
3. Click [ General ] to enter the general setting.
4. Click [ Language ] to enter the language settings.

## Microphone settings



1. Press [ ■ ] to enter the Homepage.
2. Click [ ⚙ ] to enter the setting interface.
3. Click [ General ] to enter the general setting.
4. Click [ MIC Switch ] to select F or R.  
F: Front microphone  
R: Rear microphone (Optimal microphone jack on the rear)

## Steering Wheel Learning

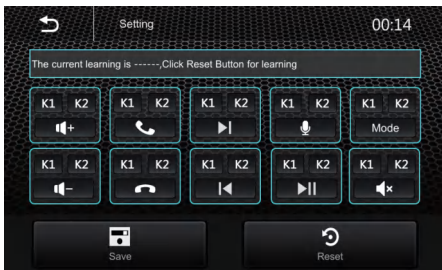

1. Press [ ■ ] to enter the Homepage.
2. Click [ ⚙ ] to enter the setting interface.
3. Click [ General ] to select [ SWC ], to enter the steering wheel learning.
4. Click on the function that needs to be learned on the screen.
5. Press the button needed for the car steering wheel.
6. Click to [ Save ].

## Key Lighting Settings

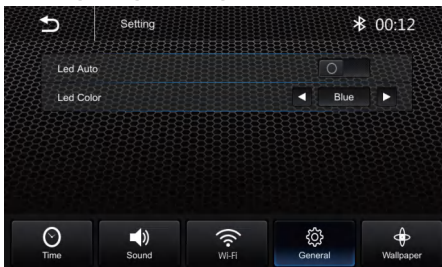



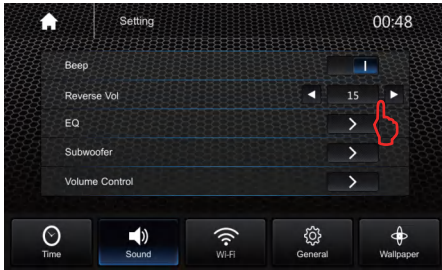

1. Press [ ■ ] to enter the Homepage.
2. Click [ ⚙ ] to enter the setting interface.
3. Click [ General ] to enter the general setting.
4. Click [ Led Colour ] to enter the key lights settings.

# SOUND SETTINGS



## Reverse Volume Adjustment



1. Press [  ] to enter the Homepage.
2. Click [  ] to enter the setting interface.
3. Click [ Sound ] to enter the sound setting.
4. Click the [  ] [  ] of the reverse volume to adjustment.

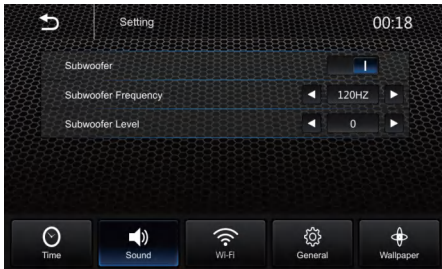

## Subwoofer Settings

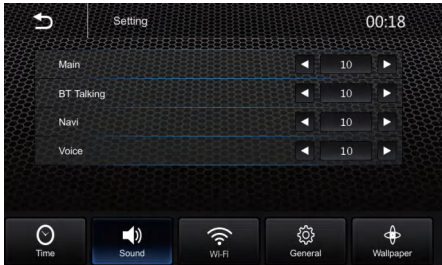

1. Press [  ] to enter the Homepage.
2. Click [  ] to enter the setting interface.
3. Click [ Sound ] to enter the sound setting.
4. Click [ Subwoofer ] to enter the subwoofer settings.  
ON  OFF

## Volume Control Settings





1. Press [  ] to enter the Homepage.
2. Click [  ] to enter the setting interface.
3. Click [ Sound ] to enter the sound setting.
4. Click [ Voice ] to enter the volume settings.

## Clock/Calendar Settings

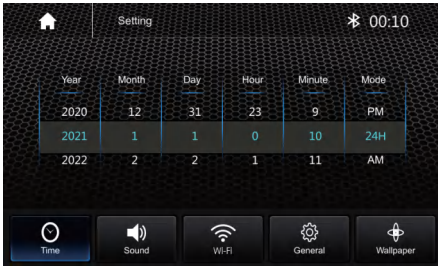
---





1. Press [] to enter the Homepage.
2. Click [] to enter the setting interface.
3. Click [Time] to enter the year, month, day and time setting.

## Custom Wallpaper

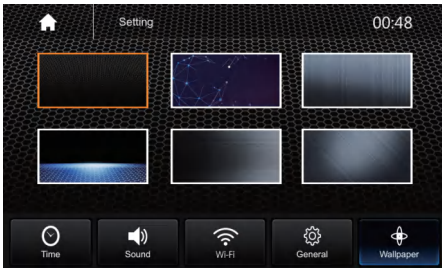
---



1. Press [] to enter the Homepage.
2. Click [] to enter the setting interface.
3. Click [Wallpaper] to enter the wallpaper replacement.
4. Select the wallpaper that needs to be replaced.
5. Click [], confirm to set wallpapers.

Remarks:

Does not support customize the wallpaper through the USB or micro SD/TF.

## COMMON TROUBLE-SHOOTING

Problem	Cause	Correct action
Can not power on	Check fuse	Change fuse same as the old one Maximum current of fuse: 15A
	Some factors cause MPU wrong operation	Press RESET button on the panel by penpoint, then, power on
After ignition switch off, setting information all lose	Change battery or fuse	Reset information and save
Poor performance of radio station	Weak signal	Move the car to another place, then research

## PRECAUTIONS ON POWER SUPPLY AND SPEAKER CONNECTIONS:

- Do not connect the speaker leads of the power cord to the car battery otherwise, the unit will be seriously damaged.
- BEFORE connecting the speaker leads of the power cord to the speakers, check the speaker wiring in your car.

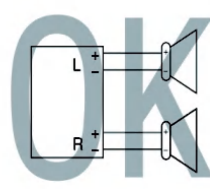
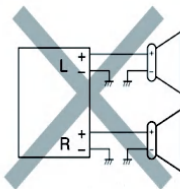
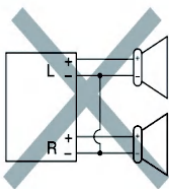



# SPECIFICATIONS

---

## General

Operation Voltage: 14.4V(10.5-16V)  
Installation Size: 178×100×126MM  
Operation Temperature: -10°C - +70°C  
Storage Temperature: -20°C - +80°C

## Radio Item

North America :  
FM Frequency Range:87.5-107.9MHZ  
AM Frequency Range:530-1710KHZ  
Europe:  
FM Frequency Range:87.5-108MHZ  
AM Frequency Range:522-1620KHZ  
Latin America:  
FM Frequency Range:87.5-108MHZ  
AM Frequency Range:520-1620KHZ

## Bluetooth Item

Communication system:  
BT 4.2 version+EDR  
Output: BT standard power 2 class  
Max communication range: 5m  
Frequency band: 2.4GHZ  
Compatible Bluetooth protocol:  
HFP/ HSP/ A2DP/ AVRCP

## TFT Screen Item

Size: 6.8 inch  
Resolution: 1024\*600RGB  
Contrast ratio: 500

## Audio Item

Max power: 50W×4  
Pre-output(V): 4V/10KΩ  
Pre-output impedance: ≤600Ω  
Speakers impedance: 4-8Ω

## USB Item

Rear USB1 : Charge (5V/1.5A)  
Rear USB2: Apple Carplay/  
Android Auto

## Support Video Format

H264/FLV/ MKV/ MPEG4

## Support Video Solution

640x480/ 1280x720/ 1920x1080

## Support Audio Format

WMA/AAC/FLAC/MP3

## Video Item

External video input system:  
NTSC/PAL/SECAM  
External video input: 1VP-P/75Ω







CONNECT WITH US ONLINE TO EXPLORE NAKAMICHI'S COMPLETE RANGE,  
INSTRUCTIONS, SOFTWARE DOWNLOADS, AND WARRANTY REGISTRATION.

[WWW.NAKAMICHICARAUDIO.COM](http://WWW.NAKAMICHICARAUDIO.COM)

 [nakamichi.global](https://www.facebook.com/nakamichi.global)  [nakamichi.caraudio](https://www.instagram.com/nakamichi.caraudio)

Nakamichi Corp, Japan. Made in China | 中國製造

此页只是文件说明, 不做印刷用!

文件名 File Name	21CHZ220-IM-V1.3	版次 Revision	V1.1
机型 Project#		比例 Scale	1:1
客户/品牌 Customer	Nakamichi	公差 Tolerance	±3mm
尺寸+P数 Size	英文版, 145*105mm, 共28p	设计 Designer	陈慧虹
材质 Material	封面G128双铜, 内页80克书写纸, 彩色印刷, 打钉	审核 Checked	陈瑞琴
工艺 technique	封面过光油	设计日期 Design Date	2022.4.20
注释: Remarks:	描述 Description		