

 Nakamichi®

User Manual













NA3600M

AV Media receiver

CONTENTS

TOUCH BUTTON FUNCTION INTRODUCTION	1 EN
REMOTE CONTROL INTRODUCTION	2 EN
FUNCTIONS APPLICATION	3 EN
SAFETY NOTE	3 EN
MAIN MENU	3 EN
RADIO	4 EN
DISC PLAY	5 EN
USB	6 EN
AV IN	6 EN
PHONE	6 EN
SETTINGS OPERATION	7 EN
PHONE LINK	9 EN
WIRING CONNECTION	10 EN
TECHNICAL SPECIFICATION	11 EN
COMMON TROUBLE-SHOOTING	12 EN
INSTALLATION SIZE	13 EN
FCC Warning	14 EN

REMOTE CONTROL INTRODUCTION

NO.	SYMBOL	OPERATION&CONTROL MODES
0	SET UP	Press this button to choose different set items.
1	OSD	Press to display the title chapter and the left time.
2	AUDIO	In DVD mode, press button to switch language of dialogue. In VCD mode, press to choose left track, right track, and stereo.
3	ANGLE	In DVD mode, press this button to change play angle.
4	REP	Repeat
5	RDM	In radio mode, press this button to switch between local and direction, In VCD, CD mode, press to randomly play.
6	INT	In disc/USB/SD playback state, press INT button can scan per song for 10 seconds.
7	SUB-T	In DVD mode, press to switch language of subtitle.
8	TITLE	In DVD mode, press to play back to the top menu of disc.
9	ZOOM/q	In DVD/VCD mode, press to ZOOM in/out.
10		Turn off/turn on, mute or unmute.
11	SOURCE	Press to choose signal source/mode switching
12_20		When playing MP3, USB, SD returns to song menu, up, down, left, right, selections .
15_17		
13		USB/SD/DISC/bluetooth music--Play or pause.
14	SYS/CLR	Clear the digital number on bluetooth dial menu.
16	ENT	Press "ENT" key to confirm.
18	LOUD/EQ	Open/close loudness.
19		Radio--Switch to the next preset USB/SD/DISC/bluetooth music--the last.
21		Radio--Switch to the next preset USB/SD/DISC/bluetooth music--the next.
22	★/SLOW	In video mode, press to slow backward and slow forward.
23	+	Short press to increase volume step by step, long press to increase volume continuously.
27	-	Short press to decrease volume step by step, long press to decrease volume continuously.
24	BND/  	In radio mode, press to choose band. Stop function in playing audio/video, hang up function in BT calling.
25	 /PHONE/ 	Can call.
26	#/MENU/PBC	Press to back to the main menu. In VCD mode, press to display all song menus, work with number button to choose songs.

SAFETY NOTE

1. Please read the instructions before using the unit, the damage caused by not following the instructions will not enjoy the warranty.
2. To drive safely and avoid break the traffic rules, do not watch program and operate the unit while driving.
3. To avoid short circuit, please do not exposure the device to rain.
4. To avoid short circuit, please do not put in the device or any metal objects left behind.
5. Not open the machine for maintenance by yourself, please go to the professional repair service station for repairing.
6. When the engine is turned off, please do not use the car audio a long time, otherwise the battery may run out.
7. Do not insert anything to the device' s vent and other openings.
8. Damage to the screen carefully! Do not use sharp objects push, rub, stroke the screen.

MAIN MENU

(pls check the actual menu display for reference)

The first time power on, unit will be default into languages setting interface, select the needed country and language, press "√" enter to main menu, as right picture, functions are as below:

: Click to enter radio interface.

: Click to enter bluetooth interface.

: Can play DVD/VCD/CD/CD-R/CD-RW/DVD+R/DVD+RWetc. format disc.

: Outside audio/video input.

: This function requires installation of related equipment.

: Click to enter phone link interface.

: Click to enter settings.

: Click to enter wallpaper.

FUNCTIONS APPLICATION

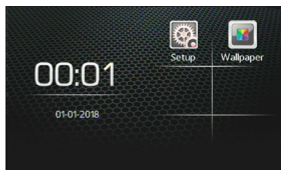
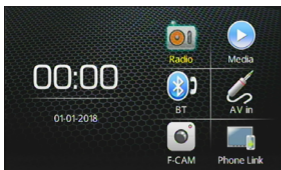

RADIO

Touch "Radio" in main menu to enter radio interface.

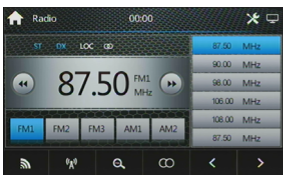



Touch  icon can return to main menu.

Touch  icon can search stations automatically.

Touch  icon can open/close LOC function.

Touch  icon, press to scan reserved station, and save the strongest signal station in the menu.

Touch  icon can open/close stereo .

Touch  icon can search to low frequency stations. Long press to low frequency search automatically.

Touch  icon can search to high frequency stations. Long press to high frequency search automatically.

FUNCTIONS APPLICATION

DISC PLAY

Play disc

Hold the disc printing side on, insert into disc slot, after system detects the disc, AV receiver will automatically intake disc and play.

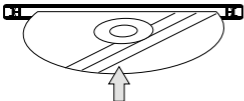

Take out Disc

Touch to take out disc.

If in 10s, disc has not been removed, system will intake disc again but not automatically play.

Attention: do not insert 2 or more discs one time.

Touch Disc from main menu to enter disc menu:

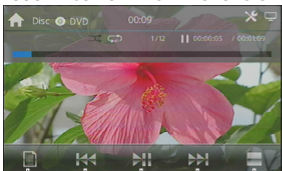

chapter selection

short press last song/ long press fast backward

play/ pause

short press next song/long /press fast forward

stop

Attention:

when disc stuck caused by using disc incorrectly or wrong operation, please long press for 3s, AV receiver's mechanism will automatically reset and return to normal.

FUNCTIONS APPLICATION

USB

When connect to external play device, AV receiver can play video/audio/picture file, and default switching to below:

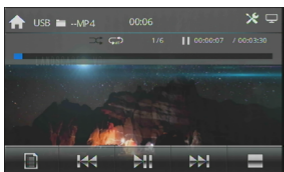
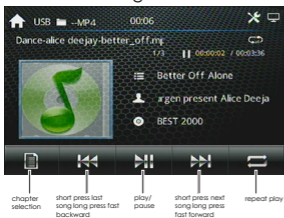

AV IN

Insert video/audio input connector to unit, touch "AV-in" icon from main menu to enter input interface.

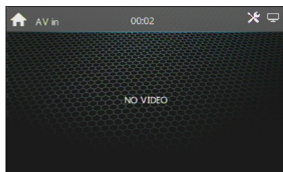

PHONE

This system provides dial free service, if your phones have wireless BT connection function, then can connect to the AV receiver, achieve dial/answer/phone book/music play functions. Touch Bluetooth icon can enter BT interface:

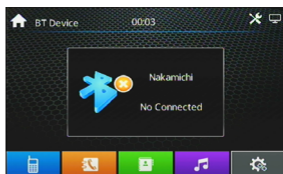

☎ Dial Phone



Calls

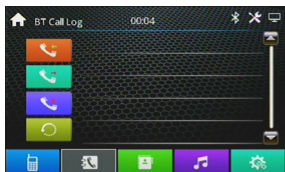

Phone book

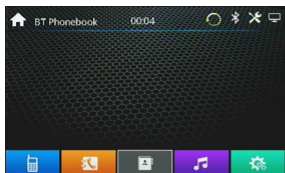

Phone music

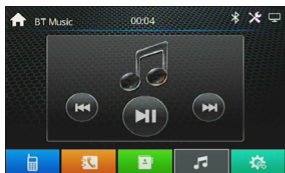

Set up

SETTINGS OPERATION

Touch "Setting" icon from main menu to enter below picture:

System setting

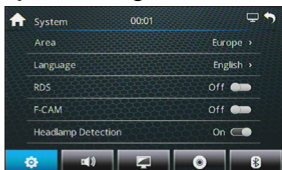

Area: Click the options can choose the different regions.
Language: Touch [Language] icon enter language setting interface, select the needed language.
F-CAM: Click icon can open/close corresponding functions.

Sound Setting

Touch icon enter sound setting interface:

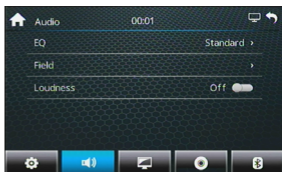

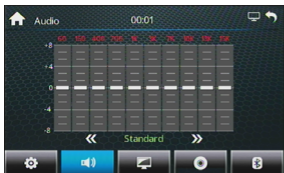

EQ: Click the options can switch EQ modes: rock/classical/jazz/etc. menu to enter below picture:

FUNCTIONS APPLICATION

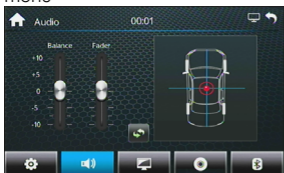

Field: Touch icon enter below menu



: Adjustment relevant functions
: Fast set sound focus's control point.

Display setting

Touch icon enter display setting interface:

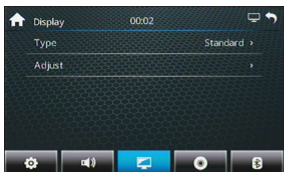

Click options can choose settings.

Media setting

Touch icon enter media setting interface:

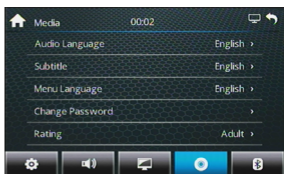

Click options can choose settings like audio, language, subtitles, etc.

BT setting

Touch icon enter BT setting interface:

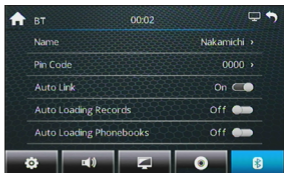

Click options can choose settings.

Time setting

Touch icon enter time setting interface.

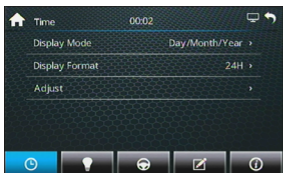

Click options can choose settings.

Light setting

Touch icon enter light setting interface.

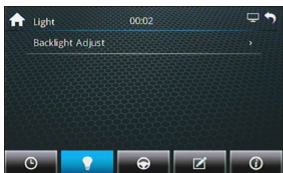

Click options can choose settings.

SWC setting

Touch icon enter SWC setting interface.

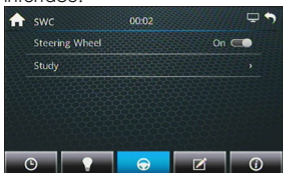

Click options can choose settings.

Factory setting

Touch icon enter factory setting interface.(password:123456)

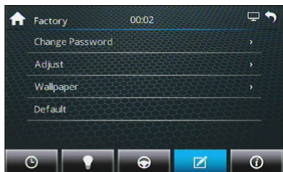

Click options can choose settings.

Version information

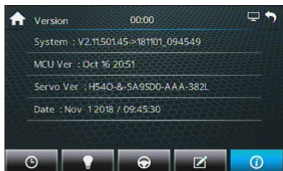

PHONE LINK

Touch "Phone link" in main menu to enter Phone link interface.

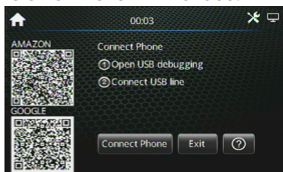

WIRING CONNECTION

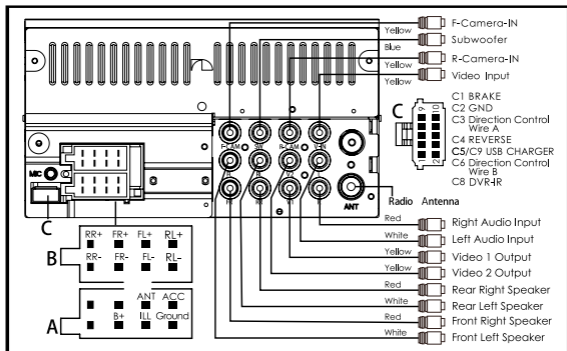

Name	Colour	Connection
A	Red	ACC
	Black	GROUND
	Blue	ANT/AMP:Auto Antenna/Amplifier
	Green	ILLUMINATE
	Yellow	B+
B	Green	Rear Left Speaker(+)
	Green / Black	Rear Left Speaker(-)
	White	Front Left Speaker(+)
	White / Black	Front Left Speaker(-)
	Grey	Front Right Speaker(+)
Grey / Black	Front Right Speaker(-)	
C	Pink	C1: BRAKE
	Black	C2: GND
	Brown	C3: Direction Control Wire A
	Orange	C4: REVERSE
	Black	C5/C9: USB CHARGER
	Brown	C6: Direction Control Wire B
	Blue / white	C8: DVR-IR

TECHNICAL SPECIFICATION

GENERAL

Operation voltage:
14.4V(10.5-16V)
Installation size(WxHxD):
178x100x152MM
Operation temperature:
-10°C — +70°C
Storage temperature:
-20°C — +80°C
Installation size(WxHxD):
178x152x100mm
Net weight: 1.92KG

TFT SCREEN ITEM

Size: 6.75 inch
Resolution: 800x480 RGB
Contrast ratio: 500

DISC PLAYBACK ITEM

Disc format:
DVD/VCD/CD/CD-R/CD- RW/
DVD+R/DVD+RW
Disc diameter: 12CM
Frequency Response: 20HZ-
20KHZ
Signal/noise ratio: >60DB
Total Harmonic Distortion: <0.3%
Channel isolation: >50DB
Video signal format: NTSC/PAL
Video output: 1+/-0.2VP-P

RADIO ITEM

FM frequency range:
87.5-108.0MHZ
AM frequency range:
522-1620KHZ

VIDEO ITEM

External video input system:
NTSC/PAL/SECAM
External video input: 1VP-P/75Ω

AUDIO ITEM

Max power: 4X50W
Pre-output(V): 4V/10KΩ
Pre-output impedance: ≤600Ω
Speakers impedance: 4-8Ω

BLUETOOTH ITEM

Communication system:
BT 4.0 version+EDR
Output:
BT standard power 2 class
Max communication range: 5m
Frequency band: 2.4GHZ
Compatible Bluetooth protocol:
HFP/HSP/A2DP/AVRCP

USB ITEM

Front USB: Read
Rear USB: Charger(5V/1A)

SUPPORT VIDEO FORMAT

H264/DIVX/FLV/MKV/MPEG4

SUPPORT VIDEO SOLUTION

640x480 1280x720 1920x1080

SUPPORT AUDIO FORMAT

MP3/WMA/FLAC

COMMON TROUBLE-SHOOTING

PROBLEM	CAUSE	CORRECT ACTION
Can not power on	Check fuse	Change fuse same as the old one
	Some factors cause MPU wrong operation	Press RES button on the panel by penpoint, then, power on
After ignition switch off, setting information all lose	Change battery or fuse	Reset information and save
Poor performance of radio station	Weak signal	Move the car to another place, then research
Can not load disk	There is a disc inside	Remove disc before inserting another one
Can not play disc	Disc is scratched	Change new disc
	Put wrong side of disc into the unit	Slot in the disc with sign side up
	Lens has dirt	Clean lens by lens clean disc
Can not switch language/subtitle	There is only one language/ subtitle in disc	If disc is not with multi-language/ subtitle, it cannot switch language/ subtitle
No image	Other factors cause MPU wrong operation	Press RES button on the panel by penpoint, then, power on
Can not watch image during driving	It's not allowed to watch image during driving	Park the car in a safe place, put the car stall in "P" position, pull up the hand brake, parking brake wire must be grounded.

INSTALLATION SIZE

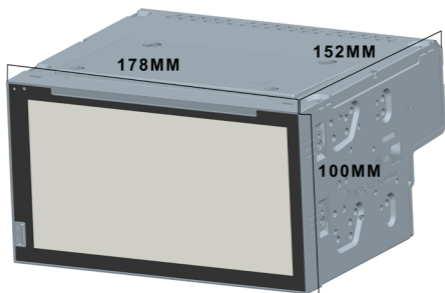

FCC Warning

This device complies with Part 15 of the FCC Rules. Operation is subject to the following two conditions:

(1) This device may not cause harmful interference, and (2) This device must accept any interference received, including interference that may cause undesired operation.

NOTE 1: This equipment has been tested and found to comply with the limits for a Class B digital device, pursuant to part 15 of the FCC Rules. These limits are designed to provide reasonable protection against harmful interference in a residential installation. This equipment generates, uses and can radiate radio frequency energy and, if not installed and used in accordance with the instructions, may cause harmful interference to radio communications. However, there is no guarantee that interference will not occur in a particular installation. If this equipment does cause harmful interference to radio or television reception, which can be determined by turning the equipment off and on, the user is encouraged to try to correct the

interference by one or more of the following measures:

- Reorient or relocate the receiving antenna.
- Increase the separation between the equipment and receiver.
- Connect the equipment into an outlet on a circuit different from that to which the receiver is connected.
- Consult the dealer or an experienced radio/TV technician for help.

NOTE 2: Any changes or modifications to this unit not expressly approved by the party responsible for compliance could void the user's authority to operate the equipment.

目錄

觸摸按鍵功能介紹	1 CN
遙控器按鍵功能介紹	2 CN
功能應用	3 CN
安全說明	3 CN
主界面	3 CN
收音機	4 CN
光盤	4 CN
USB	6 CN
AV IN	6 CN
手機	6 CN
設置操作	7 CN
手機連接	9 CN
線材連接	10 CN
技術規格	11 CN
常見故障排除指南	12 CN
安裝尺寸	13 CN

觸摸按鍵功能介紹

附件清單

1. AV 接收器 -----1 個
2. 電源線 -----1 套
3. 遙控器 -----1 個
4. 安裝護套 -----1 個
5. 用戶手冊 -----1 本
6. USB 線 -----1 條



1. **進出碟鍵**：短按取出 / 輸入光盤。
2. **音量 +**：短按可增加音量，長按音量不斷增大。
3. **電源鍵**：在通電狀態下，按下此按鍵即可開機 / 關機
4. **音量 -**：短按可減小音量，長按音量不斷減小。
5. **主菜單鍵**：按進入主菜單。
6. **USB**：可以從 USB 讀取文件，也可以複製文件到 USB 里。

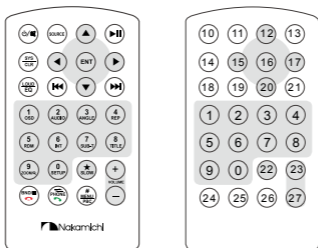

遙控器按鍵功能介紹

序號	名稱	操作和控制模式
0	SET UP	按此按鈕可選擇不同的設定項目。
1	OSD	按顯示標題章節和左側時間。
2	AUDIO	在 DVD 模式下，按按鈕切換對話語言。 在 VCD 模式下，按選擇左軌道，右軌道和立體聲。
3	ANGLE	在 DVD 模式下，按此按鈕可更改播放角度。
4	REP	重複
5	RDM	在收音機模式下，按此鍵可在本地和方向之間切換，在 VCD，CD 模式下，按可隨機播放。
6	INT	在光盤 / USB / SD 播放狀態下 按 INT 按鈕可以每首歌曲掃描 10 秒鐘。
7	SUB-T	在 DVD 模式下，按切換字幕語言。
8	TITLE	在 DVD 模式下，按此按鈕可播放光盤的頂層菜單。
9	ZOOM/Q	在 DVD / VCD 模式下，按 ZOOM 進 / 出。
10	🔇/🔊	關閉 / 打開靜音或取消靜音。
11	SOURCE	按選擇信號源 / 模式切換
12_20	▲_▼	播放 MP3/USB/SD 時返回歌曲菜單，可按上、下、左、右鍵來選擇。
15_17	◀_▶	
13	▶	USB / SD / DISC / 藍牙音樂 - 播放或暫停。
14	SYS/CLR	清除藍牙撥號菜單上的數字。
16	ENT	按“ENT”鍵確認。
18	LOUD/EQ	打開 / 關閉響度。
19	⏮	收音機 - 切換到下一個預設 USB / SD / DISC / 藍牙音樂 - 最後一個。
21	⏭	收音機 - 切換到下一個預設 USB / SD / DISC / 藍牙音樂 - 下一個。
22	★/SLOW	在視頻模式下，按下後慢速倒回 / 慢速前進。
23	+	短按可逐步增加音量， 長按可持續增加音量。
27	-	短按可逐步減小音量， 長按可連續減小音量。
24	BND/📶/📞	在收音機模式下，按下選擇 Band, Stop 功能播放音頻 / 視頻，在 BT 通話中可掛機。
25	📞/PHONE/📞	可通話
26	#/MENU/PBC	按返回主菜單。 在 VCD 模式下，按顯示所有歌曲菜單，使用數字按鈕選擇歌曲。

功能應用

安全說明

1. 使用本機前請閱讀說明書，不遵守說明書所造成的損壞將不享受保修。
2. 為了安全駕駛並避免違反交通規則，請勿在駕駛時觀看程序並操作本機。
3. 為避免短路，請勿將設備暴露在雨中。
4. 為避免短路，請勿將設備或任何遺留的金屬物品放入。
5. 請勿自行打開機器進行維修，請到專業維修站進行維修。
6. 發動機關閉時，請勿長時間使用汽車音響，否則電池可能會耗盡。
7. 請勿在設備的通風口和其他開口處插入任何物品。
8. 小心擦拭屏幕！不要使用尖銳的物體推，擦，劃線屏幕。

主界面

(請查看實際菜單顯示以供參考)

第一次開機，單位將默認為語言設置界面，選擇所需的國家和語言，按“√”進入主菜單，如右圖所示，功能如下：

：點擊進入收音機界面。

：點擊進入藍牙界面。

：可以播放 DVD / VCD / CD / CD-R / CD-RW / DVD + R / DVD + RW 等格式光盤。

：外部音頻 / 視頻輸入。

：此功能需要安裝相關設備。

：點擊進入手機鏈接界面。

：點擊進入設置界面。

：點擊進入壁紙界面。

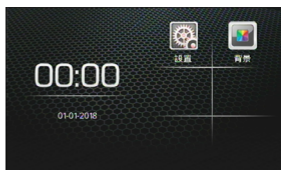



功能應用

收音機

觸摸主菜單中的“收音機”進入收音機界面。





觸摸  圖標，可返回主菜單。

觸摸  可切換 FM1/FM2/FM3/AM1/AM2。

觸摸  可以打開 / 關閉 LOC 功能。

觸摸  圖標，短按即可掃描保留站，長按可以自動搜索，並在菜單中保存最強信號站。

觸摸  可以打開 / 關閉 ST 功能。

觸摸  圖標可以搜索到低頻站。長按自動搜索低頻。

觸摸  圖標可以搜索到高頻站。長按自動搜索高頻。

光盤播放

播放光盤

將光盤打印面朝上，插入光盤插槽，系統檢測到光盤後，AV 接收器將自動進光盤播放。

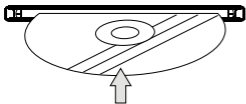

功能應用

取出光盤

觸摸  圖標，可取出光盤。

如果在 10s 時間內，光盤尚未移除，系統將再次吸入光盤但不會自動播放。

 **注意：**一次不要插入 2 張或更多光盤。

從主菜單光盤鍵進入光盤菜單：



注意：

當使用光盤導致光盤卡住時，操作不正確或錯誤，請長按  3 秒，AV 接收機的機械裝置將自動復位並恢復正常。

USB

當連接到外部播放設備時，AV 接收器可以播放視頻 / 音頻 / 圖片文件，默認切換到以下：



功能應用

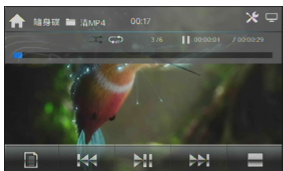

AV IN

將視頻輸入接口插入輸入視頻輸入插孔，音頻輸入接口輸入音頻輸入插孔，從主菜單觸摸“AV-in”圖標進入輸入接口。

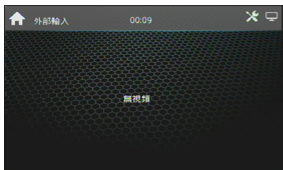

手機

本系統提供撥號免費服務，如果您的手機具有無線 BT 連接功能，則可以連接到 AV 接收器，實現撥號/接聽 / 電話簿 / 音樂播放等功能。觸摸藍牙圖標可以進入 BT 界面：



撥打電話



來電記錄

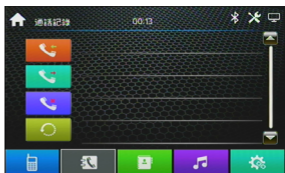

功能應用

: 電話簿

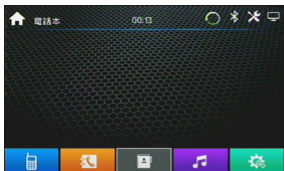

: 音樂



: 設置

設置操作

觸摸主界面中的“設置”圖標菜單進入下圖：

系統設置



區域: 單擊選項可以選擇不同的區域。

語言: 觸摸 [語言] 圖標進入語言設置界面，選擇所需語言。

F-CAM: 點擊 **Off** 圖標可以打開 / 關閉相應的功能。

聲音設置

觸摸圖標進入聲音設置界面：

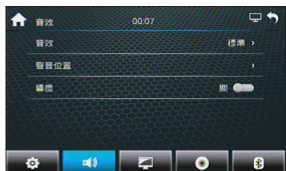

EQ: 點擊選項可以切換 EQ 模式：搖滾 / 古典 / 爵士 / POP / 流行等。

菜單進入下图：

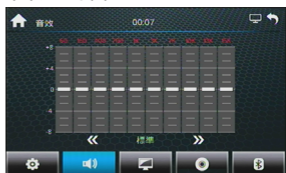

功能應用

現場：觸摸圖標進入菜單如下



：調整相關功能

：快速設置聲音焦點的控制點。

顯示設置

觸摸圖標進入顯示設置界面：

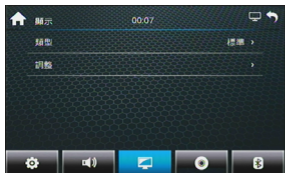

單擊選項可以選擇設置。

媒體設置

觸摸圖標進入媒體設置界面：



單擊選項可以選擇設置。

藍牙設置

觸摸圖標進入藍牙設置界面：

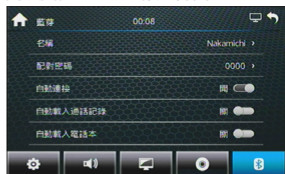

單擊選項可以選擇設置。

時間設置

觸摸圖標進入時間設置界面：



單擊選項可以選擇設置。

燈光設置

觸摸圖標進入燈光設置界面：

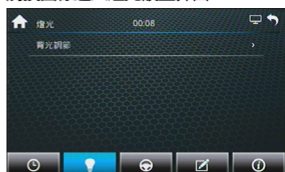

單擊選項可以選擇設置。

SWC 設置

觸摸圖標進入 SWC 設置界面：

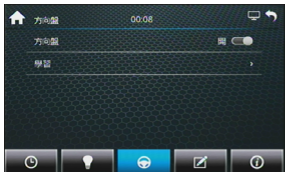

單擊選項可以選擇設置。

工廠設置

觸摸圖標進入出廠設置界面。（密碼：123456）



單擊選項可以選擇設置。

版本信息

觸摸圖標進入版本信息界面：



手機鏈接

觸摸主菜單中的“手機鏈接”進入手機鏈接界面：

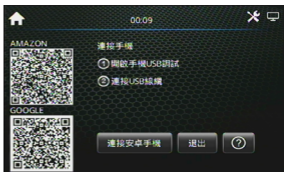

線材連接

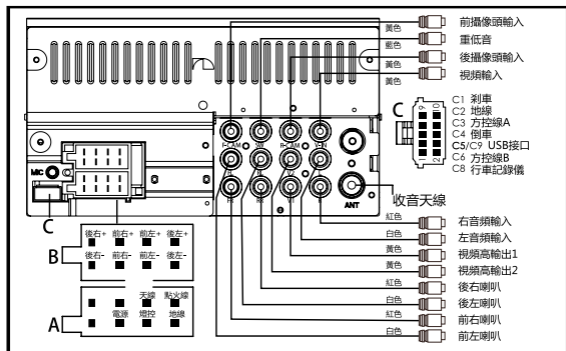

名稱	顏色	連接
A	紅色	點火線
	黑色	地線
	藍色	ANT/AMP: 自动天线/放大器
	綠色	燈控
	黃色	電源
B	綠色	後左喇叭 (+)
	綠色 / 黑色	後左喇叭 (-)
	白色	前左喇叭 (+)
	白色 / 黑色	前左喇叭 (-)
	灰色	前右喇叭 (+)
	灰色 / 黑色	前右喇叭 (-)
C	紫色	后右喇叭 (+)
	紫色 / 黑色	后右喇叭 (-)
	粉色	C1: 剎車
	黑色	C2: 地線
	棕色	C3: 方控線A
	橘色	C4: 倒車
	黑色	C5/C9: USB 接口
	棕色	C6: 方控線B
	藍色 / 白色	C8: 行車記錄儀

技術參數

常規

電壓：14.4V(10.5-16V)
尺寸 (WxHxD)：
178x100x152MM
工作溫度：-10° C – +70° C
儲存溫度：-20° C – +80° C
安裝尺寸 (WxHxD)：
178x152x100mm
淨重：1.92KG

TFT 顯示器選項

顯示屏尺寸：6.75 寸
顯示分辨率：800x480 RGB
對比度：500

碟片播放選項

碟片格式：
DVD/VCD/CD/CD-R/CD- RW/
DVD+R/DVD+RW
碟片直徑：12CM
頻率響應：20HZ-20KHZ
信號 / 噪音比：>60DB
總諧波失真比：<0.3%
聲道分離度：>50DB
視頻信號格式：NTSC/PAL
視頻輸出：1+/-0.2VP-P

收音機選項

FM 調頻範圍：87.5-108.0MHZ
AM 幅度範圍：522-1620KHZ

USB 界面選項

前置 USB：讀取
後置 USB：接口 (5V / 1A)

視頻選項

外部視頻輸入系統：
NTSC/PAL/SECAM
外部視頻輸入：1VP-P/75Ω
音頻選項
最大功率：4X50W
前置輸出 (V)：4V /10KΩ
前置輸出阻抗：≤ 600Ω
揚聲器阻抗：4-8Ω

藍牙選項

通信系統：BT 4.0 版 + EDR
輸出：藍牙標準功率 2 級
最大通信範圍：大概 5 米
頻段：2.4 赫茲
兼容的藍牙協議：
HFP/ HSP/ A2DP/ AVRCP

支持視頻格式

H264/DIVX/FLV/MKV/MPEG4
支持視頻分辨率
640x480 1280x720 1920x1080

支持音頻格式

MP3/WMA/FLAC

常見故障排除指南

故障	原因	解決方法
不能開機	電源供電保險絲燒壞	更換同型號保險絲
	其它因素造成微處理器工作異常	用尖端物體點按面板上的複位孔，重新開機
點火開關關閉後，設置的信息全部丟失	更換蓄電池或保險絲	重新設置信息並保存
收台效果差	電台信號弱	將車移動到另外一個位置重新搜索
無法放入光碟	機芯內已裝有碟片	退出機內碟片，再插入碟片
碟片不能播放	碟片劃傷	更換良好碟片
	光碟正反面放反	將碟片的標志面朝上放入機內
	激光光頭臟污	用光頭清洗液清洗光頭
不能進入語言 / 字幕轉換	光碟只刻錄了一種語言 / 字幕	沒有多種語言、字幕的光碟不能進入語言 / 字幕切換
無圖像	其它因素造成微處理器工作異常	用尖端物體點按面板上的複位孔，重新開機
行車過程中無法觀看圖像	行車過程中不允許觀看影像	請將車停到安全位置，將車檔置于 P 檔，拉起手剎

安裝尺寸

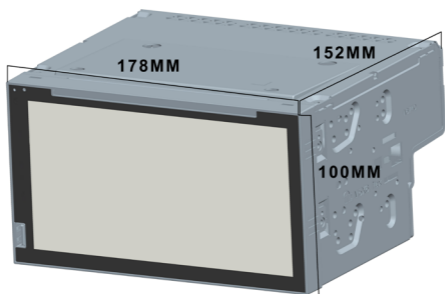

FIND US ON:

 www.nakamichicaraudio.com

 [Nakamichi.Global](https://www.facebook.com/Nakamichi.Global)

 [Nakamichi.caraudio](https://www.instagram.com/Nakamichi.caraudio)