

PARTS LIST for Models 9.5, 12 and 18 Air Fractionating Water Pumps

#	Description	9.5	12	18
1	Motor - Model #	9.5	12	18
	Impeller * See Note			
2a	Regular- ITEM #	12746	12756	12776
2b	Fractionating*	16745	16755	16775
3	O-ring Seal			
4	Pump Cover	ITEM # 12733	12741	12741
5	Screw Set			
6	Self Adhesive Vibration Pad			
7	Air Control Valve			
8	Air Tube Connector			
9	Air Muffler			
10	Air Induction Tube			
11	Venturi Intake Tube			
12	Strainer Set			
13	Foam Filter			
14	(Supreme Hydroponics Models 40129, 40132 & 40138 only) ³ / ₄ FPT x ¹ / ₂ Barb Adaptor ITEM # 12723			

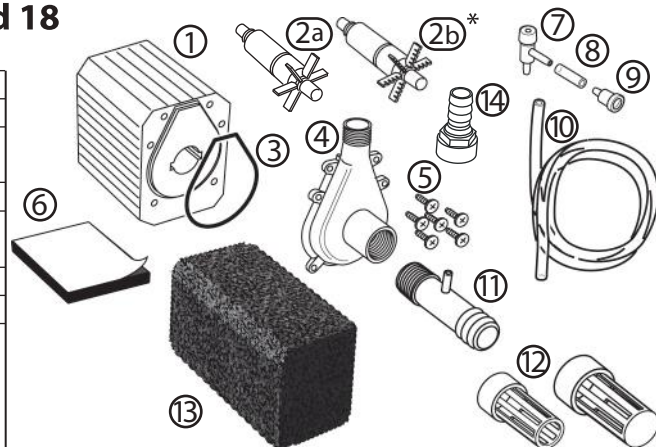

* Note: Hydroponic models ship with Regular Impeller. Fractionating impeller can also be purchased separately and used to induce even finer bubbles into water stream.

Troubleshooting:

Problem	Possible Cause	Solution
Pump stops working or runs slowly	Bad power supply	Check all power connections, GFCI and circuit breakers. Test using a different power source.
	Impeller is locked with debris	Check if Impeller will turn. Disconnect power, remove Volute to check that Impeller can be turned. If not, perform Impeller maintenance.
	Intake clogged	Disconnect power and remove the obstruction.
	Impeller is worn out	Replace Impeller; see parts list.
Pump will not prime	Foam Cartridge clogged	Remove and Rinse in separate bowl filled with aquarium water. Chlorinated tap water will kill off any helpful bacteria that have colonized. Replace if too worn.
	Pump design is NOT self priming	Position Pump below water level, fill hose with water and re-start.
Air is not drawn in through Venturi system	Tubing kinked	Straighten out tubing or replace using standard aquarium tubing.
	Valve closed	Turn valve knob counter clockwise.
	Pump submerged too deep	Elevate Pump. Air induction diminishes with increased depth of the Pump. Check that Air Muffler is completely above water's surface.
Water leaks out of venturi intake	Air intake is below water level	Water is backing up through pump. Secure the Air Muffler and Air Control Valve above water's surface.
Water leaks from Barbed fitting connection	No Teflon Tape on threads	Remove fitting, wrap threads with at least two turns of Teflon Tape and reassemble securely.
	Loose Tubing	Use a stainless steel hose clamp around tubing to maintain tight tube fit.

LIMITED WARRANTY

E.G. Danner Mfg. Inc. will repair or replace any pump found to be defective as follows: Pump body within five years of original purchase; Impeller and attachments within one year of original purchase. Cutting or altering cord removing or defacing product labels voids any warranty consideration. For warranty repair return only the part that is defective to our factory. Please include a dated proof of purchase and \$5.00 for postage and handling. Damages or injuries resulting from negligence, shipping, handling, improper installation, maintenance or misuse of the product are not covered by warranty. This warranty gives you specific legal rights. You may have other rights which vary from state to state.

To validate this warranty keep your proof of purchase (Copy of sales receipt).

DANNER MFG. INC. • Islandia, New York 11749-1489 • Visit our web site at www.dannermfg.com

ZG109 revB 9/11

Supreme®

SAVE THESE
INSTRUCTIONS

Magnetic Drive Pump with Venturi Intake and Air Fractionating Impeller

CARE AND OPERATING INSTRUCTIONS

MODEL	ITEM #'s	
9.5	06010	40129
12	06012	40132
18	06018	40138

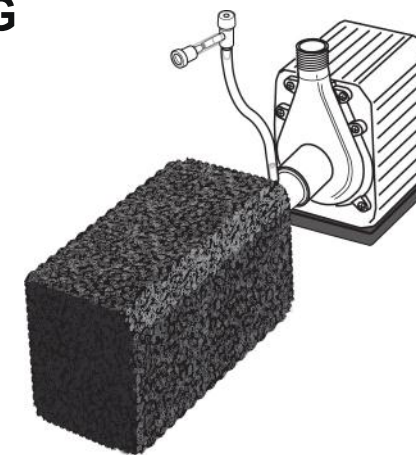

WARNING! PONDS ARE DANGEROUS TO SMALL CHILDREN!
NEVER LEAVE CHILDREN UNSUPERVISED NEAR A POND.

Thank you for purchasing this Supreme product. This continuous duty Pump is designed for use with filtration systems and other applications that call for dissolved oxygen mixed into the water column. The Venturi Air Intake draws water into the Impeller chamber where it is fractionated to micro-bubbles before it leaves the Pump Discharge Outlet. The Pump incorporates a highly efficient magnetic drive motor and matched Impeller with a ceramic shaft to provide energy savings while maintaining high output.

This Pump can be used submersed or in-line. Note that when used in-line it should be placed below the water level since it is not self priming. Never run this Pump dry.



ELECTRICAL PRECAUTIONS

Always use a properly grounded outlet. Do not immerse the plug in water. **DO NOT REACH INTO THE WATER TO REMOVE THE PLUG. TURN OFF CIRCUIT FIRST.** A "drip loop" in the cords should be used. A "drip loop" is a loop in the cord below the level of the receptacle or plug that prevents water from traveling along the cord. The National Electric Code requires that a ground fault interrupter circuit (GFCI) be installed in every branch circuit supplying the fountain or pond equipment. Your dealer can supply GFCI units. **NEVER REMOVE GROUND PIN FROM PLUG.**

WARNING: FOR YOUR PROTECTION, ALWAYS UNPLUG THE UNIT FROM ITS POWER SOURCE BEFORE INSTALLING OR SERVICING. DO NOT REACH, REMOVE OR DISASSEMBLE BEFORE YOU DISCONNECT POWER.

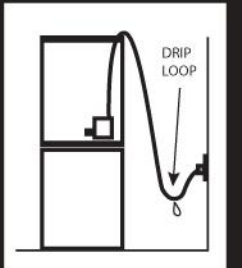

OPERATION PRECAUTIONS

- Never run Pump dry.
- Only use this Pump with clean water.
- Never use Pump for liquids other than water.
- Pump is not intended to move water that contains large non-dissolved solids.
- Make certain that all electrical connections have a GFCI installed.
- Note for In-Line applications: Please avoid threading long straight unsupported pipes to the Volute. Unsupported pipes add immense stress to Volute that may compromise the seal once filled with water.
- Note: If using Venturi air intake, always keep the valve / muffler above the water surface level of your set-up. If power fails, the water will backwash into the air tube -- up to the water surface level.

Assembly and Operation Instructions

This pump can be used submersed or inline, both with or without the Venturi Air Intake.

The Venturi Intake provides air induction when the airline is connected to the small air intake port. It attaches to the threaded 3/4" FPT intake of the Pump Volute. Turn until secure; do not over-tighten. Use plumber's Teflon tape on threaded pipe fittings. This will aid in assembly and future disassembly.

Attach the Air Muffler to the Air Control Valve using the Air Tube Connector to create the Air Control Assembly. Attach the Air Control Assembly to the Venturi Air Intake Port using the Air Induction Tube. Secure Air Valve / Muffler assembly above water surface level.

The **Barbed end of the Venturi Tube** attaches to 1" flexible tubing. It can be secured with a small hose clamp (not supplied) for extra security. The top of the Air Valve must always be above water level to prevent water back-flow if power is interrupted. An inline Check Valve can be purchased and installed to prevent back flow of water into the Air Tubes.

The **Pipe Thread Volute** can be used without the Venturi intake tube assembly either submersed or in-line, non submersed. For in-line use the Pump must be primed and should be operated below the water level. A separate in-line check valve is strongly recommended to prevent loss of prime if power is interrupted.

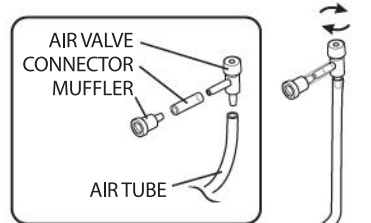

ALWAYS USE TEFLON TAPE* ON THREADED FITTINGS.
*(not supplied)

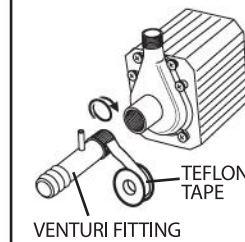

STEPPED BARB FITTING

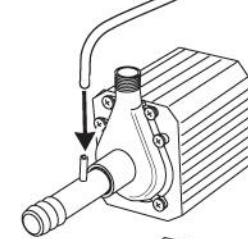

Peel and stick vibration pad to bottom of pump.

When using Foam Block **WITHOUT** Venturi, use larger closed-end Strainer

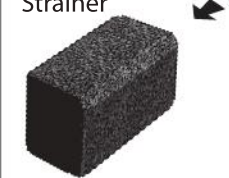

When using Foam Block **WITH** Venturi, use smaller open-ended Strainer

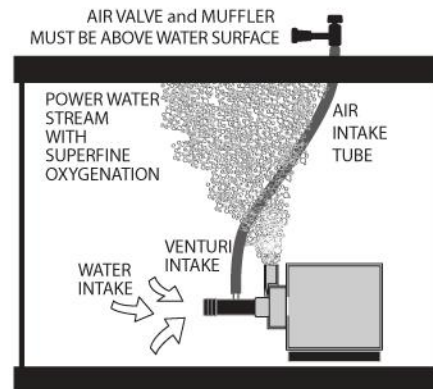
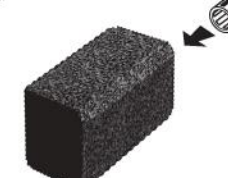

Maintenance / Impeller Replacement:

This Pump does not require any lubrication or special maintenance. Periodically cleaning the Impeller will maintain Pump performance and extend Pump life. It is particularly important to perform Impeller cleaning when Pump is in water with high mineral content such as salt water aquariums. Scale will build up on the ceramic shaft inside Impeller. It can be removed by soaking the Impeller in a solution of 1 part vinegar to 8 parts water overnight and rinsing off the calcium deposits.

To access impeller:

- 1) Completely disconnect Pump from power supply.
- 2) Remove hoses and bring Pump to a clear work area.
- 3) Remove 6 screws to remove Volute.
- 4) Pull Volute straight forward from pump.
- 5) Pull the Impeller out from the chamber.
- 6) Clean Impeller with fresh water or vinegar solution only, never any solvents.
- 7) Reverse steps to reassemble. If rubber O-Ring became detached, clean it and press it back around the track on the motor housing.

