

FAST RACK[®]

EQUIPMENT LLC

“The Solution for Finishing Doors and More!”



SALES

Michael Halverson
920-585-0230
Michael@FastRackEquipment.com

OPERATIONS MANAGER

Stacey Mischker
920-422-5031
Stacey@FastRackEquipment.com



“Your Spray Booth Finishing Solutions”

“COME SPRAY WITH US!”

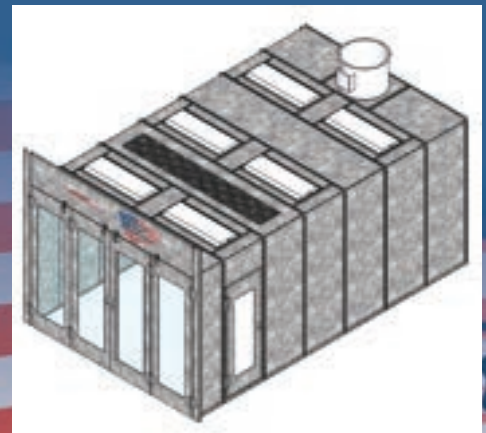

www.FastRackEquipment.com



Professional Grade Finishing & Racking Equipment

Welcome to Fast Rack Equipment.

We are pleased to offer you a whole new world of finishing possibilities. Our professional grade finishing and racking equipment is designed and manufactured with you in mind. The construction and painting industries demand efficient use of time and superior wood finishing techniques. Fast Rack Equipment will not only save time and labor costs but will increase productivity as well.

Single-User Friendly

Fast Rack Equipment has single-user capabilities. Our equipment allows a single-user to rotate, finish both sides, and rack various sizes of doors, cabinet doors, window sills, stair end caps, trim, and molding simultaneously.



On-Site Finishing

Fast Rack Equipment can be disassembled and moved from shop to the jobsite easily. The racking and spraying carts have a left and right side, and telescopic tubing that are reassembled with quick-connect pins.



Mobile

Fast Rack Equipment can be assembled and disassembled, no tools needed. With just a few quick-connect pins it can be assembled in minutes.



“Our mission is to provide innovative quality equipment and services to all finishing industries. We are committed to improve the lives and livelihoods of these professionals by providing them with effective, efficient, ergonomic equipment that will propel them to be more profitable.” **Fast Rack Equipment Team**

“The Solution For Finishing Doors!”

System 1.....\$4,815.00



This system includes:

- 1 Drying Rack (Casters: 3-1/2" (2) Rigid & (2) Swivel).....Part# FRE-4101
- 1 Spray Transfer Cart (Casters: 3-1/2" (2) Swivel & (2) Swivel w/Brake).....Part# FRE-3101
- 15 Sets of Door Handles.....Part# FRE-1101
- 1 Set of Sawhorses.....Part# FRE-2101

Effective

Production will never have to halt due to staffing difficulties or equipment failure. Equipment effectiveness produces efficiency.



Efficient

Keep your workplace organized and increase production while saving time and labor costs.



Features:

One-Man Operation

- Finish up to 15 doors in a footprint of one door
- Finish both sides of a door simultaneously with one finisher
- Adjustable length to accommodate doors from 5'7" to 10'
- Different height finishers will benefit from the ergonomic design
- Superior finish when spraying horizontally
- Created for a shop or jobsite setting
- Portable equipment with collapsible design using quick-connect pins
- Assembles and disassembles in minutes

System 1 Video



Scan Me

System 2.....\$4,112.00



This system includes:

- 1 Drying Rack (Casters: 3-1/2" (2) Rigid & (2) Swivel)..... Part# FRE-4101
- 1 Adjustable Cart (Casters: 3-1/2": (2) Rigid, (1) Swivel & (1) Swivel w/Brake)..... Part# FRE-5101
- 15 Sets of Door Handles..... Part# FRE-1101
- 1 Set of Sawhorses..... Part# FRE-2101

Ergonomic

Allows the user to quickly adjust work height with quick-connect pins for a more comfortable and "custom" workstation.

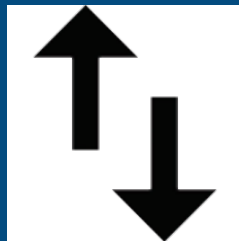

Equipment

Fast Rack Equipment allows the user to work efficiently and effectively. Engineered for Service and Safety.

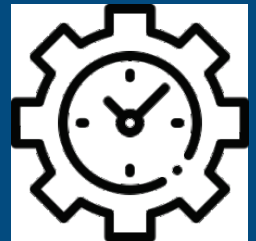

Features:

Two-Man Operation

- Finish up to 15 doors in a footprint of one door
- Adjustable length to accommodate doors from 5'7" to 10'
- Finish both sides of a door simultaneously
- Superior finish when spraying horizontally
- Created for a shop or jobsite setting
- Portable equipment with collapsible design using quick-connect pins
- Assembles and disassembles in minutes

System 2 Video



Scan Me

“The Solution For Finishing Doors!”

System 3.....\$3,587.00



This system includes:

- 1 Set of Vertical Drying Rack Accessories.....Part# FRE-6106
- 2 Adjustable Carts (Casters: 3-1/2" (2) Rigid, (1) Swivel, & (1) Swivel w/Brake).....Part# FRE-5101
- 11 Sets of Door Handles.....Part# FRE-1101
- 1 Set of Sawhorses.....Part# FRE-2101

Effective

Production will never have to halt due to staffing difficulties or equipment failure. Equipment effectiveness produces efficiency.



Efficient

Keep your workplace organized and increase production while saving on time and labor costs.



Features:

Two-Man Operation

- Holds up to 11 doors in a footprint of one door
- Adjustable length to accommodate doors from 5'7" to 10'
- Doors dry vertically
- Great for heavy commercial doors
- Created for a shop or jobsite setting
- Portable equipment with collapsible design using quick-connect pins
- Assembles and disassembles in minutes

**System 3
Video**



Scan Me

System 4.....\$4,290.00



This system includes:

- 1 Spray Transfer Cart (Casters: 3-1/2" (2) Swivel, & (2) Swivel w/Brake).....Part# FRE-3101
- 1 Adjustable Cart (Casters: 3-1/2" (2) Rigid, (1) Swivel, & (1) Swivel w/Brake).....Part# FRE-5101
- 1 Set of Vertical Drying Rack Accessories.....Part# FRE-6106
- 1 Set of Sawhorses.....Part# FRE-2101
- 11 Sets of Door Handles.....Part# FRE-1101

Ergonomic

Allows the user to quickly adjust work height with quick-connect pins for a more comfortable and "custom" workstation.

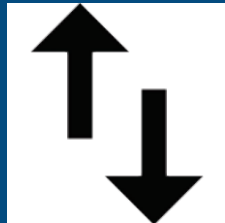

Equipment

Fast Rack Equipment allows the user to work efficiently and effectively. Engineered for Service and Safety

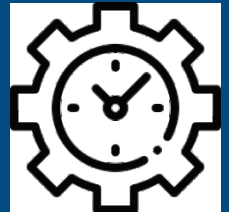

Features:

One-Man Operation

- Adjustable Length from 5'7" to 10'
- Finish up to 11 doors in a footprint of one door
- Doors dry vertically
- Finish both sides of a door simultaneously with one finisher
- Created for a shop or jobsite setting
- Portable equipment with collapsible design using quick-connect pins
- Assembles and disassembles in minutes



“The Solution For Finishing Doors!”

System 5.....\$1,978.00

System 5 Video



Scan Me

OPTION:
Add (3) 3-1/2” Threaded Swivel Casters & (1) Threaded Caster with Brake to Spray Station for ease of moving in and out of spray area!



Holds up to **40** Cabinet Doors

This system includes:

- 1 Cabinet Drying Tower (Casters: 3-1/2” (3) Threaded Swivel & (1) with Brake) Part# FRE-12101
- 1 Triple Rotating Spray Station Part# FRE-13101

Features:

Cabinet Drying Tower Minimal-Contact

- **V-shape** arms allows a cabinet door edge to rest on four points
- The handle station allows the user to move the rack, place their spray gun, sanding block, stain rags, cell phone, and even a beverage on it
- Rods are removable to adjust for different height items, such as drawer boxes



Triple Rotating Spray Station

- Spray up to 3 cabinet doors at once
- Triple Rotating Spray Station is height adjustable from 2’8” to 3’8”
- Spray platform four points are adjustable to hold different size cabinet doors
- Spray platform rotates 360 degrees allowing the user to spray the cabinet door from one side
- Capability to spray and dry larger cabinet doors, shutters, or even panels

Spray Station Platform

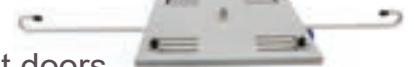

System 6.....\$1,623.00

System 6 Video



Scan Me

OPTION:
Add (3) 3-1/2” Threaded Swivel Casters & (1) Threaded Caster with Brake to Spray Station for ease of moving in and out of spray area!



Holds up to **25** Cabinet Doors

This system includes:

- 1 Mini Cabinet Drying Tower (Casters: 3-1/2” (3) Threaded Swivel & (1) with Brake)Part# FRE-14101
- 1 Triple Rotating Spray StationPart# FRE-13101

System 7.....\$3,473.00

NEW

“No Sway Finishing System”

Top of spray station
4' 3" x 2' Wide



Height: 6' 4" is the average.

46 Cabinet Door Drying Rack



4' 4" Long x 2' 2" Wide

This system includes:

- 1 No Sway Dual Spray Station (Casters: 3-1/2" (2) Swivel & (2) Swivel w/brake)Part# FRE-NoSway
- 1 46 Cabinet Vertical Door Drying Rack (Casters: 3-1/2" (2) Swivel & (2) Swivel w/brake).....Part# FRE-46Rack
- 30 IKE Brackets.....Part# FRE-IKE

Features:

No Sway Dual Spray Station

- No Sway Spray Station rotates 360 degrees allowing a user to spray both sides at once
- IKE bracket prevents cabinet doors and other items not to sway when spraying
- Professional grade casters allows easy movement in and out of spray areas
- Spray Station is height adjustable for ergonomics
- Spray cabinet doors, shutters, and small panels
- Created for a shop or jobsite setting
- Assembles and disassembles in minutes

IKE Bracket



“No Sway”

46 Cabinet Vertical Door Drying Rack

- Dry up to 46 cabinet doors
- Professional grade casters for easy movement
- Precision laser cut individual holes designed to hold IKE Bracket in place



Adjustable Cart



**Adjusts 5'7" to 10'
in Length**
(custom length available)

**Proudly Made
In The USA**



The Adjustable Cart is our most versatile piece of equipment!
We have a variety of accessories that transforms the cart into a workhorse for your company.



Add (2) **Trims Arms** to the Adjustable Cart to create a storage cart

Wheel or store trim packages at the workplace or jobsite



Add (2) **Vertical Door Drying Rack** Accessories to the Adjustable Cart to create a vertical drying rack



Add (2) **Cross Supports** to bottom of the Adjustable Cart to finish large items such as cabinet bases



The **360 Door Lock** slides over door handle with a screw mechanism to allow a user to lock the door in any position within 360 degrees. Great for spraying or working on a door.



Add (2) **Door Handles** to finish both sides of a door simultaneously.

Adjustable Cart



Adjustability: 5'7" to 10' Length (custom length available)
Quick-Connect Pin: Length Adjustment
Mobile: 3-1/2" Casters; (2) Rigid, (1) Swivel, & (1) Swivel w/Brake
Accessories: Door Handles, Vertical Door Drying Rack Accessories, Cross Supports, and Trim Arms.
Part Number: FRE-5101

Vertical Door Drying Rack Accessories

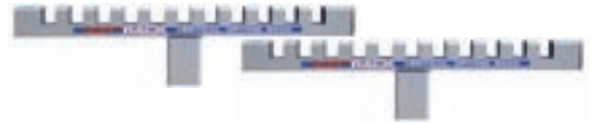

Ability: Holds up to 11 doors vertically
Space Savings: As little as a 9" x 3" space
Ease: Sets onto the Adjustable Cart
Single-User: Transfer a door while wet
Part Number: FRE-6106

Door Handles



Rotation: Ease to finish both sides of a door
Transfer: Ability to transfer to a drying rack
Part Number: FRE-1101

Trim Arms



Holds Trim: Used on Adjustable Cart
Spray Cabinet Doors: Used with Adjustable Cart and Cross Supports
Part Number: FRE-6101

360 Door Lock



Versatility: Lock Door into any position when using the Adjustable Cart or Transfer Cart
Ease: The Door Lock slides over door handle with a screw mechanism to allow a user to lock the door in any position within 360 degrees. Great for spraying or working on a door.
Part Number: FRE-360LK

Adjustable Sawhorses



Adjustability: Adjust to 6 heights
Open-Ended: Single-User to transfer door onto the Adjustable Cart or Spray Transfer Cart
Part Number: FRE-2101

Drying Rack



Adjustability: 5'7" to 10' Length (custom length available)
Quick-Connect Pins: Length Adjustment
Mobile: 3-1/2" Casters; (2) Rigid, (2) Swivel
Collapsible: 8 Quick-Connect Pins
Ability: Disassembles & Reassembles
Accessory: Drying Rack Slider
Part Number: FRE-4101

Drying Rack Slider



Adjustability: Slider can be bolted anywhere between left and right side of the Drying Rack
Mobile: 3-1/2" Casters; (2) Swivel
Capability: Added support to dry miscellaneous size items
Part Number: FRE-4140

Cross Supports



Drying Rack: Two Cross Supports can be placed on the arms of the drying rack allowing users to place small or big items to dry.

Adjustable Cart: Used to support cabinet bases while spraying/drying
Part Number: FRE-10101



Spray Transfer Cart



Adjustability: 5'7" to 10' Length (custom length available)
Quick-Connect Pins: Length Adjustment
Mobile: 3-1/2" Casters; (2) Swivel & (2) Swivel w/brake
Single-User: Single-User to transfer door while door is still wet
Ability: Disassembles & Reassembles
Part Number: FRE-3101

FAST RACK®

EQUIPMENT LLC

Professional Grade Finishing & Racking Equipment

Welcome to Fast Rack Equipment.

We are pleased to offer you a whole new world of finishing possibilities. Our professional grade finishing and racking equipment is designed and manufactured with you in mind. The construction and painting industries demand efficient use of time and superior wood finishing techniques. Fast Rack Equipment will not only save time and labor costs but will increase productivity as well.

Triple Rotating Spray Station



OPTION:
Add casters to spray station for ease of moving in and out of spray area!

- Spray platforms rotates 360 degrees allowing the user to spray the whole door from one side
- Spray three cabinet doors at once
- Ergonomic - the workstation height can be adjusted using two quick-connect pins
- The spray platforms' our points are adjustable
- Capability to spray large items e.g., shutters or panels by putting them over both spray platforms

Part Number: FRE-13101

Spray Station Platform



Cabinet Drying Tower Minimal-Contact

Holds up to 40 Cabinet Doors



Footprint
3.5' x 2.5'
x 7.9'

- **V-Shaped** arms allow minimal contact. If the doors were to stick you will not get a line across the whole door
- Arms are removable to adjust for different height items, such as drawer boxes
- Handle Station allows a user to move the rack around work place and hang a spray gun when moving cabinet doors to the drying tower
- Handle Station platform allows a user to place a beverage, sanding block, and cell phone on it
- Handle Station two side extensions for stain rags
- Handle Station can be bolted on at an ergonomic height

Part Number: FRE-12101

Mini Cabinet Drying Tower Minimal-Contact



Footprint
3.5' x 2.5'
x 5.2'

Holds up to 25 Cabinet Doors

Part Number: FRE-14101

Minimal-contact arms are similar to a v-shape allowing just the ends of the cabinet door to rest. Does not touch the back side of the cabinet door.

NEW

No Sway Dual Spray Station



Top of spray station
4' 3" x 2' Wide

Height: 6' 4" is the average.

- No Sway Spray Station rotates 360 degrees allowing a user to spray both sides at once
- IKE bracket prevents cabinet doors and other items not to sway when spraying
- Professional grade casters allows easy movement in and out of spray areas
- Spray Station is height adjustable for ergonomics
- Spray cabinet doors, shutters, and small panels

Part Number: FRE-NoSway



IKE Bracket

Part Number: FRE-IKE



46 Cabinet Vertical Door Drying Rack

NEW



4'4" Long x 2'2" Wide

- Dry up to 46 cabinet doors
- Professional grade casters for easy movement
- Precision laser cut individual holes designed to hold IKE Bracket in place

Part Number: FRE-46Rack

FAST RACK® EQUIPMENT LLC

Michael@FastRackEquipment.com
Cell: 920-585-0230



Customer Name: _____

Shipping Questions:

Company Name: _____

Business Location? Yes / No

Address: _____

Residential Location? Yes / No

Email Address: _____

Forklift on site? Yes / No

Phone Number: _____

Loading Dock on site? Yes / No

Equipment Sold Separately

Order one of our Packaged Systems OR Customize a System for your needs

Qty	PRODUCT DESCRIPTION	Part #	List Price	Total
	Adjustable Cart	FRE-5101	792.00	
	Vertical Door Drying Rack Accessory (2)	FRE-6106	562.00	
	Trim Arm (2)	FRE-6101	252.00	
	360 Door Lock	FRE-360LK	91.00	
	Spray Transfer Cart	FRE-3101	1,495.00	
	Drying Rack	FRE-4101	1,495.00	
	Drying Rack Slider	FRE-4140	712.00	
	Adjustable Sawhorse (2)	FRE-2101	385.00	
	Door Handle (2)	FRE-1101	96.00	
	Cross Support (2)	FRE-10101	193.00	
	Mini Minimal-Contact Cabinet Drying Tower	FRE-14101	895.00	
	Minimal-Contact Cabinet Drying Tower	FRE-12101	1,250.00	
	Triple Rotating Spray Station	FRE-13101	728.00	
	No Sway Dual Spray Station	FRE-NoSway	1,324.00	
	46 Cabinet Vertical Door Drying Rack	FRE-46Rack	1,294.00	
	IKE Bracket	FRE-IKE	28.50	
	3-1/2" Swivel Caster	SW3.5	32.00	
	3-1/2" Swivel Caster w/Brake	SWBR3.5	43.00	
	4" Swivel Caster	SW4	36.00	
	4" Swivel Caster w/Brake	SWBR4	46.00	
	3-1/2" Swivel Caster UPGRADE	SWU3.5	18.00	
	3-1/2" Swivel Caster w/Brake UPGRADE	SWBRU3.5	29.00	
	4" Swivel Caster UPGRADE	SWU4	20.00	
	4" Swivel Caster w/Brake UPGRADE	SWBRU4	30.00	
	3-1/2" Threaded Caster	TH3.5	38.00	
	3-1/2" Threaded Caster w/Brake	THBR3.5	46.00	
	White Booth Coating - 5 gallon	FRE-Coat	315.00	
	3M Dirt Trap Protection Material-28"	FRE-DT28	710.00	
	3M Dirt Trap Material Floor Dispenser-28"	FRE-DTP28	379.00	
	Spray Booth Filters - 20x20x1 (Qty. 48)	FRE-48FLTR	175.00	

FAST RACK[®]

EQUIPMENT LLC

“Our mission is to provide innovative quality equipment and services to all finishing industries. We are committed to improve the lives and livelihoods of these professionals by providing them with effective, efficient, ergonomic equipment that will propel them to be more profitable.”

Fast Rack Equipment Team

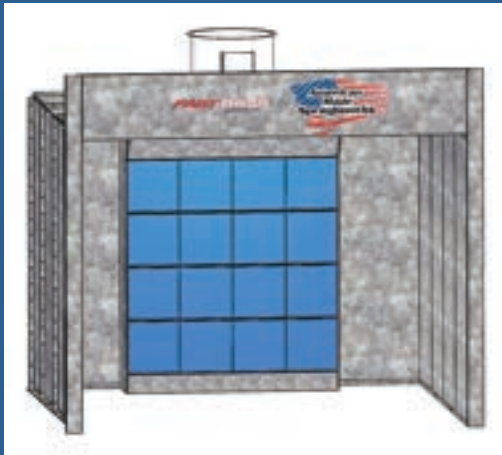

Fast Rack Equipment Spray Booths are used mainly in woodworking, light and heavy industrial, automotive, manufacturing, machining, and more.

Our spray booths are ideal in helping to create a superior finish and a perfect environment for the finisher.

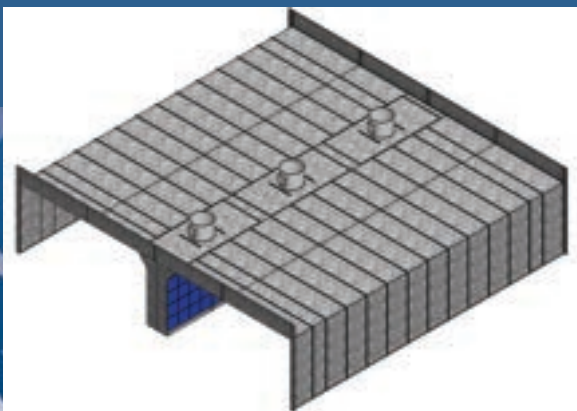
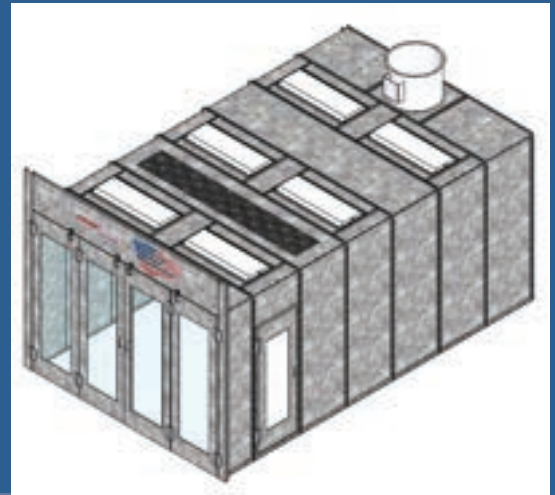

The Fast Rack Equipment Team appreciates the opportunity to help you in selecting the right spray booth for your company!

“Your Spray Booth Finishing Solutions”

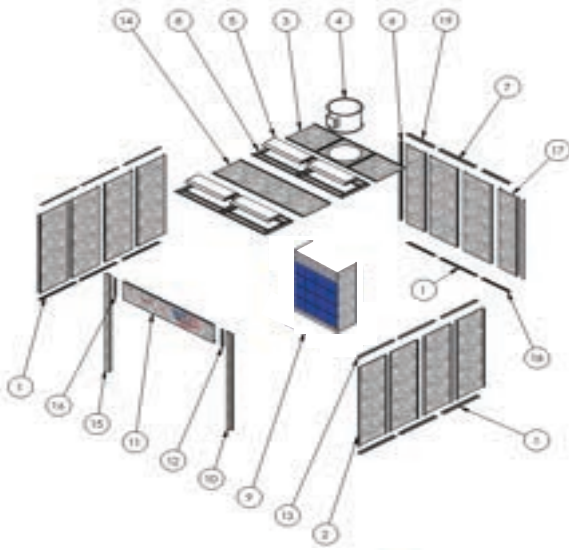

10x12x9

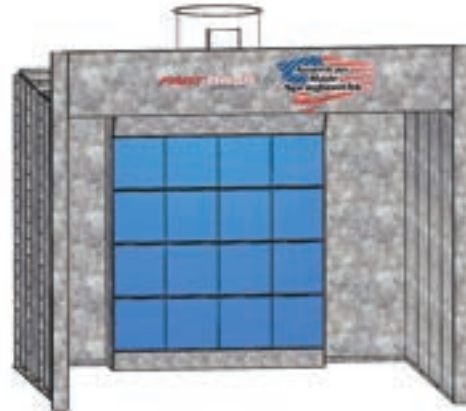

Booth Specifications

- (4) 4 Tube LED T8 light fixtures
- (1) 30" Diameter Tubeaxial belt drive exhaust fan
- (1) 3hp 3ph motor 208-230/460v. 60 hz
- (1) Mark II 25 Dwyer manometer kit defines air flow pressure
- (16) Exhaust filters with (16) exhaust filter grids
- (1) Hardware set for assembly

OPTION: (1) 3hp motor, **single-phase**, 1,740 RPM, 115/230V AC, 184T

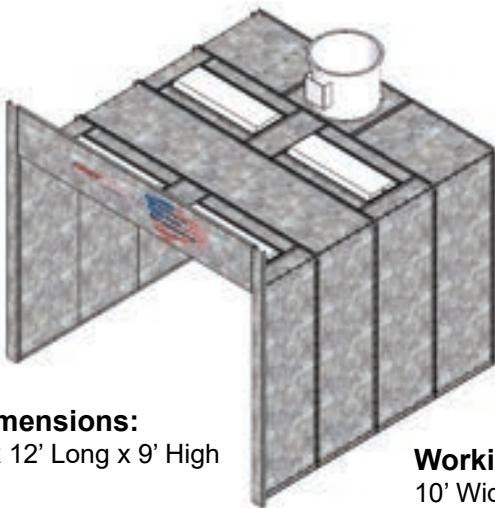

Inside Dimensions:

10' Wide x 12' Long x 9' High

Working Dimensions:

10' Wide x 10' Long (2' for the Plenum) x 9' High

Outside Dimensions:

11' Wide (the front support makes the booth wide in the front only)

12'4" Long (the body of the spraybooth)

11' High (2' for the header)



Note: When deciding the length of your booth refer to the working dimensions. You will lose 2' length inside of the booth for the Plenum (filter wall). Plenum approximately 2 feet wide.

Fast Rack Equipment Open Face Spray Booths are ideal for creating a superior finish and the perfect environment for the finisher. Open Face Spray Booths are used mainly in woodworking, light and heavy industrial, automotive, manufacturing, machining, and more.

Our spray booths are all made from 18-gauge galvanized steel and comply with NFPA-33 standards for spray application using flammable or combustible materials. Our electrical components are UL Certified to meet nationally recognized safety and sustainability standards.

The Fast Rack Equipment team is here to assist you in choosing one of our standard spray booths or creating the perfect custom spray booth with the help of our engineers.

FAST RACK®

EQUIPMENT LLC

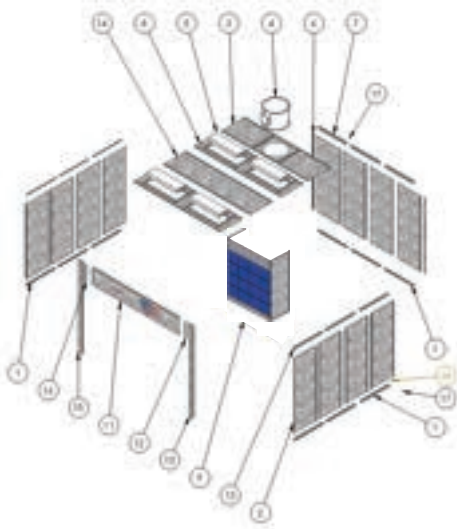

12x12x9

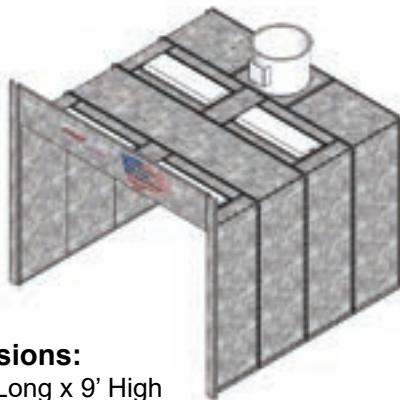
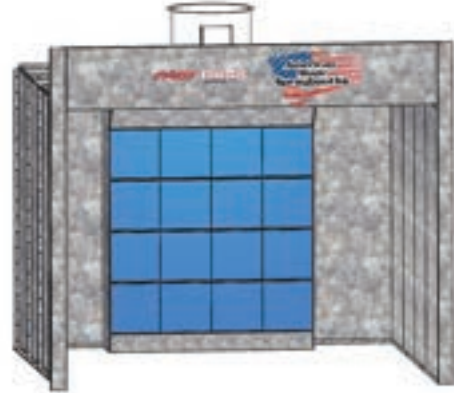

Booth Specifications:

- (4) 4 Tube LED T8 light fixtures
- (1) 30" Diameter Tubeaxial belt drive exhaust fan
- (1) 3hp 3ph motor 208-230/460v. 60 hz
- (1) Mark II 25 Dwyer manometer kit defines air flow pressure
- (16) Exhaust filters with (16) exhaust filter grids
- (1) Hardware set for assembly

OPTION: (1) 3hp motor, single-phase, 1,740 RPM, 115/230V AC, 184T

Inside Dimensions:

12' Wide x 12' Long x 9' High

Working Dimensions:

12' Wide x 10' Long (2' for the Plenum) x 9' High

Outside Dimensions:

13' Wide (the front support makes the booth wide in the front only)
 12'4" Long (the body of the spray booth)
 11' High (2' for the header)



Note: When deciding the length of your booth refer to the working dimensions. You will lose 2' length inside of the booth for the Plenum (filter wall). Plenum approximately 2 feet wide.

Fast Rack Equipment Open Face Spray Booths are ideal for creating a superior finish and the perfect environment for the finisher. Open Face Spray Booths are used mainly in woodworking, light and heavy industrial, automotive, machining, manufacturing, and more.

Our spray booths are all made from 18-gauge galvanized steel and comply with NFPA-33 standards for spray application using flammable or combustible materials. Our electrical components are UL Certified to meet nationally recognized safety and sustainability standards.

The Fast Rack Equipment team is here to assist you in choosing one of our standard spray booths or creating the perfect custom spray booth with the help of our engineers.

“Your Spray Booth Finishing Solutions”

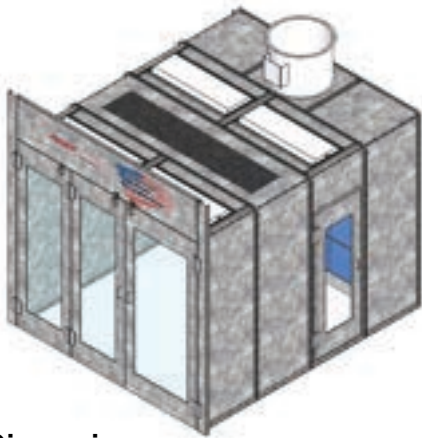
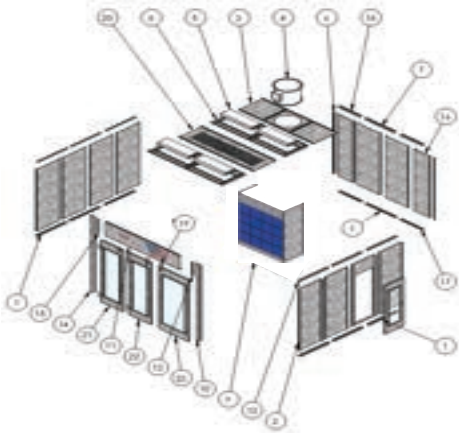

10x12x9



Booth Specifications:

- (1) front Bi-Fold Doors
- (1) front Single Door
- (1) access side Man Door
- (4) 4 Tube LED T8 light fixtures
- (1) 30" Diameter Tubeaxial belt drive exhaust fan
- (1) 3hp 3ph motor 208-230/460v. 60 hz
- (1) Mark II 25 Dwyer manometer kit defines air flow pressure
- (16) Exhaust filters with (16) exhaust filter grids
- (1) Intake filter pad
- (1) Hardware set for assembly

OPTION: (1) 3hp motor, single-phase, 1,740 RPM, 115/230V AC, 184T

Inside Dimensions:

10' Wide x 12' Long x 9' High

Outside Dimensions:

- 11' Wide (the front support makes the booth wide in the front only)
- 12'4" Long (the body of the spray booth)
- 11' High (2' for the header)

Working Dimensions:

10' Wide x 10' Long (2' for the Plenum) x 9' High



Note: When deciding the length of your booth refer to the working dimensions. You will lose 2' length inside of the booth for the Plenum (filter wall). Plenum approximately 2 feet wide.

Fast Rack Equipment Semi-Down Draft Spray Booths are ideal for creating a superior finish and the perfect environment for the finisher. Semi-Down Draft Spray Booths are mainly used in woodworking, light and heavy industrial, automotive, manufacturing, machining, and more.

Our spray booths are all made from 18-gauge galvanized steel and comply with NFPA-33 standards for spray application using flammable or combustible materials. Our electrical components are UL Certified to meet nationally recognized safety and sustainability standards.

The Fast Rack Equipment team is here to assist you in choosing one of our standard spray booths or creating the perfect custom spray booth with the help of our engineers.

“COME SPRAY WITH US!”



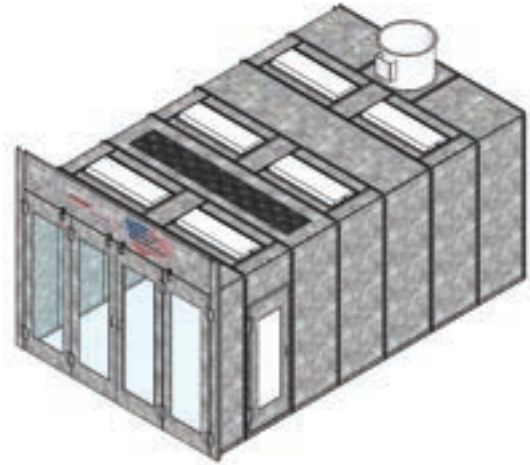
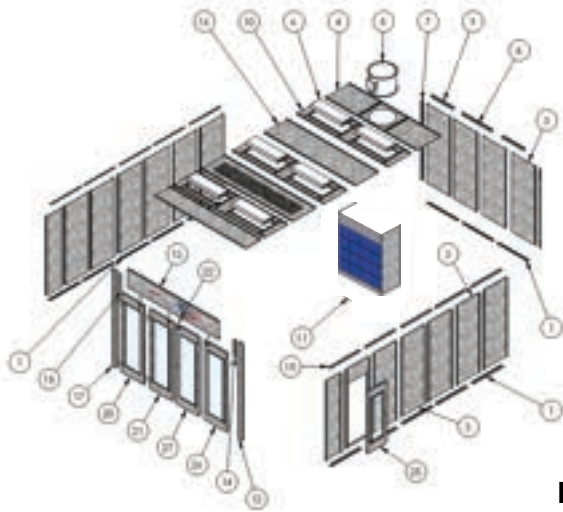

Inside Dimensions:
12' Wide x 20' Long x 9' High

Outside Dimensions:
13' Wide (the front support makes the booth wide in the front only)
20'4" Long (the body of the spray booth)
11' High (2' for the header)

Working Dimensions:
12' Wide x 18' Long (2' for the Plenum) x 9' High



Note: When deciding the length of your booth refer to the working dimensions. You will lose 2' length inside of the booth for the Plenum (filter wall). Plenum approximately 2 feet wide.

12x20x9

Booth Specifications:

- (2) sets of front Bi-Fold Doors
- (1) access side Man Door
- (6) 4 Tube LED T8 light fixtures
- (1) 30" Diameter Tubeaxial belt drive exhaust fan
- (1) 3hp 3ph motor 208-230/460v. 60 hz
- (1) Mark II 25 Dwyer manometer kit defines air flow pressure
- (16) Exhaust filters with (16) exhaust filter grids
- (1) Intake filter pad
- (1) Hardware set for assembly

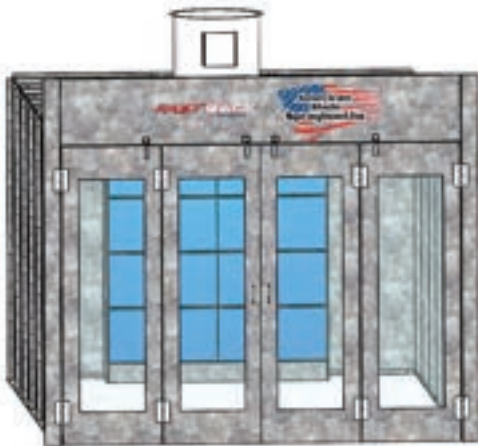

OPTION: (1) 3hp motor, **single-phase**, 1,740 RPM, 115/230V AC, 184T

“Your Spray Booth Finishing Solutions”

14x27x9

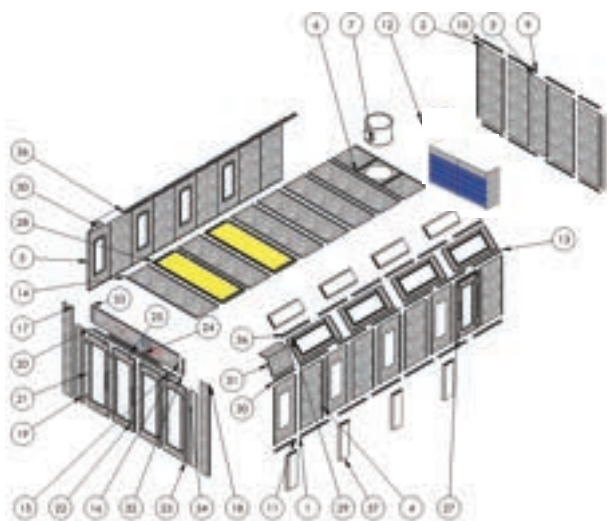

Booth Specifications:

- (2) sets of front Bi-Fold Doors
- (1) side access Man Door
- (16) 4 Tube LED T8 light fixtures
- (1) 30" Diameter Tubeaxial belt drive exhaust fan
- (1) 3hp 3ph motor 208-230/460v. 60 hz
- (1) Mark II 25 Dwyer manometer kit defines air flow pressure
- (16) Exhaust filters with (16) exhaust filter grids
- (2) Intake filter pads
- (1) Hardware set for assembly

OPTION: (1) 3hp motor, **single-phase**, 1,740 RPM, 115/230V AC, 184T

Inside Dimensions:

14' Wide x 27' Long x 9' High

Outside Dimensions:

15' Wide (the front support makes the booth wide in the front only)

27'4" Long (the body of the spraybooth)

11' High (2' for the header)

Working Dimensions:

14' Wide x 25' Long (2' for the Plenum) x 9' High



Note: When deciding the length of your booth refer to the working dimensions. You will lose 2' length inside of the booth for the Plenum (filter wall). Plenum approximately 2' feet wide.

Fast Rack Equipment Semi-Down Draft Spraybooths are ideal for creating a superior finish and a healthy environment for the finisher. Semi-Down Draft Spraybooths are used mainly in industries like woodworking, light and heavy industrial, automotive, manufacturing, machining, and more.

Our spray booths are all made from 18-gauge galvanized steel and comply with NFPA-33 standards for spray application using flammable or combustible materials. Our electrical components are UL Certified to meet nationally recognized safety and sustainability standards.

The Fast Rack Equipment team is here to assist you in choosing one of our standard spray booths or creating the perfect custom spray booth with the help of our engineers.

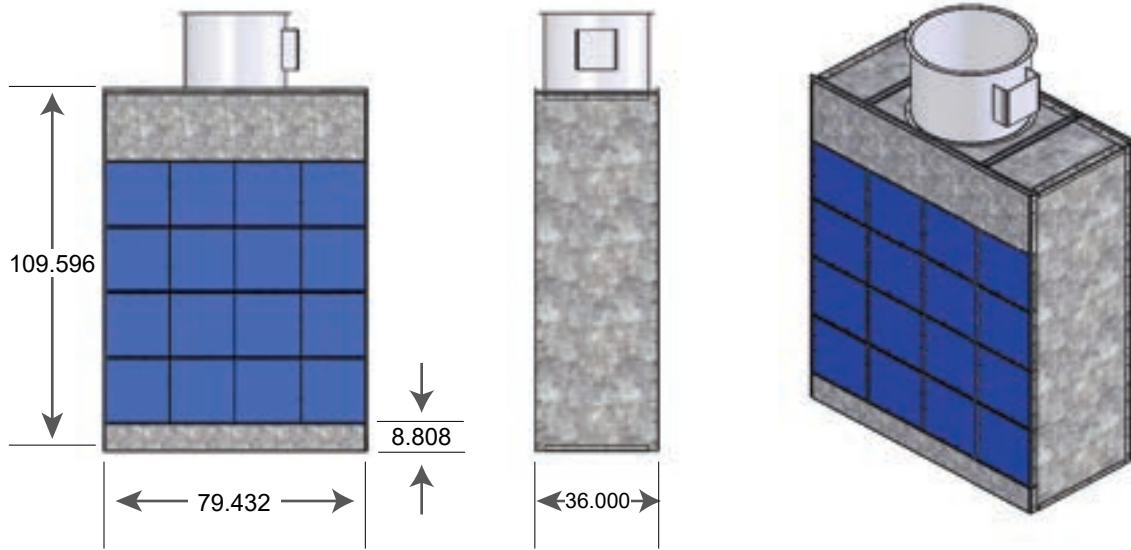

Single Plenum

Dimensions:

79.432" Wide x 109.596" High x 36" Deep

Single Plenum Specifications:

- (1) 30" Diameter Tubeaxial belt drive exhaust fan
- (1) 3hp 3ph motor 208-230/460v. 60 hz
- (16) Exhaust filters with (16) exhaust filter grids
- (1) Hardware set for assembly

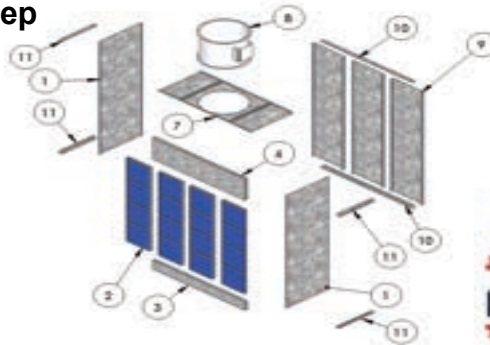

OPTION: (1) 3hp motor, **single-phase**, 1,740 RPM, 115/230V AC, 184T

OPTION: Add Lights

Fast Rack Equipment **Industrial Free Standing Single Plenum** allows the user to turn a room into a spray area and a healthy working environment for the finisher. Stand-alone plenums are used mainly in woodworking, light and heavy industrial, automotive, manufacturing, machining, and more.

Our plenums are all made from 18-gauge galvanized steel and comply with NFPA-33 standards for spray application using flammable or combustible materials. Our electrical components are UL Certified to meet nationally recognized safety and sustainability standards.

The Fast Rack Equipment team is here to assist you in choosing one of our standard plenums or creating the perfect custom fan plenum with the help of our engineers.

“Your Spray Booth Finishing Solutions”

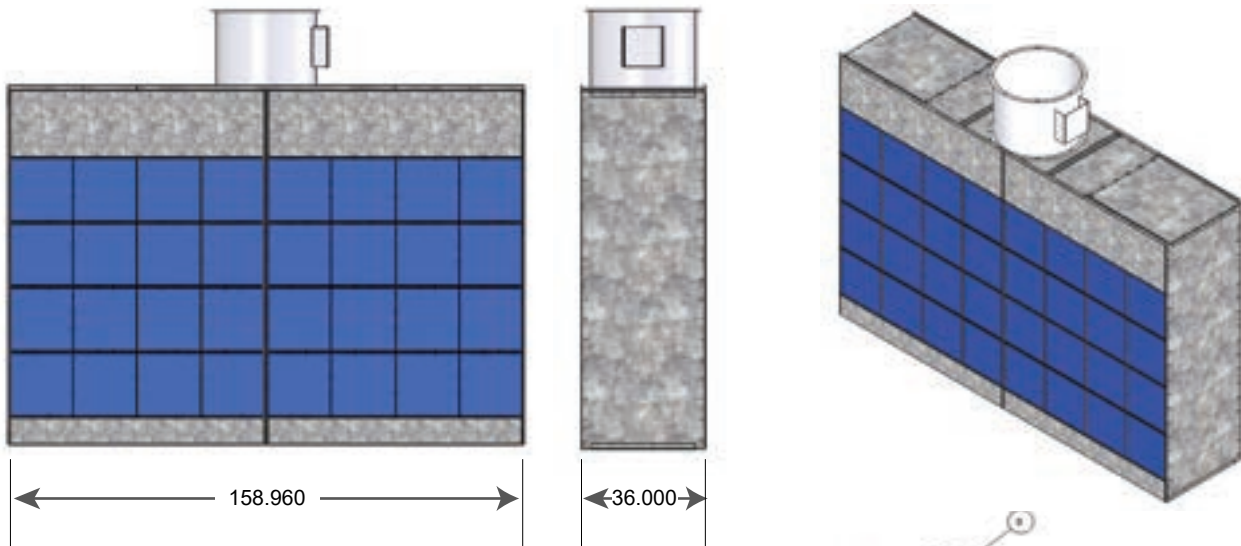

Double Plenum

Dimensions:

158.96” Wide x 109.596” High x 36” Deep

Double Plenum Specifications:

- (1) 30” Diameter Tubeaxial belt drive exhaust fan
- (1) 3hp 3ph motor 208-230/460v. 60 hz
- (32) Exhaust filters with (32) exhaust filter grids
- (1) Hardware set for assembly

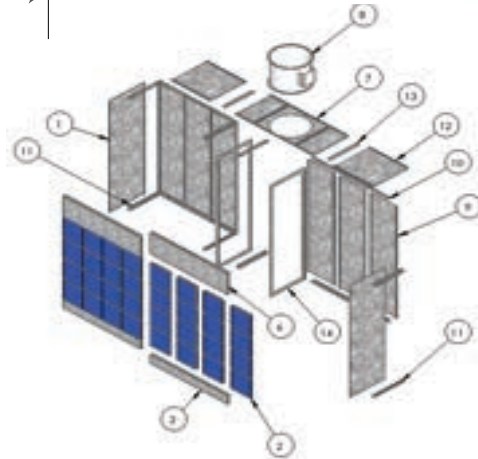

OPTION: (1) 3hp motor, **single-phase**, 1,740 RPM, 115/230V AC, 184T

OPTION: Add Lights

Fast Rack Equipment Industrial Free Standing Double Plenum allows the user to turn a room into a spray area and a healthy working environment for the finisher. Stand-alone plenums are used mainly in woodworking, light and heavy industrial, automotive, manufacturing, machining, and more.

Our plenums are all made from 18-gauge galvanized steel and comply with NFPA-33 standards for spray application using flammable or combustible materials. Our electrical components are UL Certified to meet nationally recognized safety and sustainability standards.

The Fast Rack Equipment team is here to assist you in choosing one of our standard plenums or creating the perfect custom plenum with the help of our engineers.

“COME SPRAY WITH US!”



“Your Spray Booth Finishing Solutions”

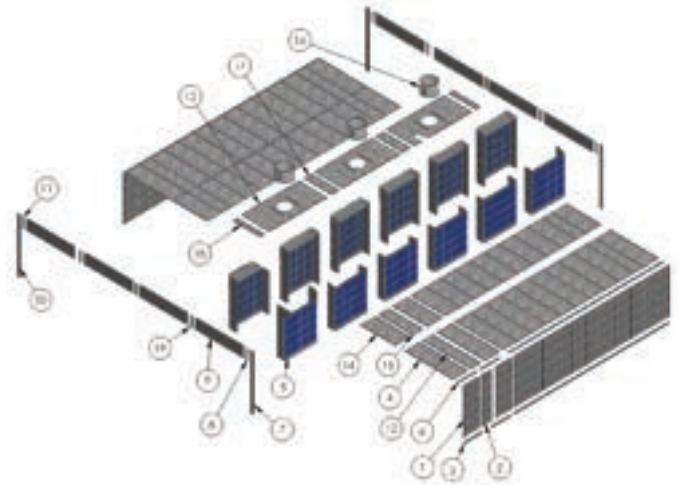
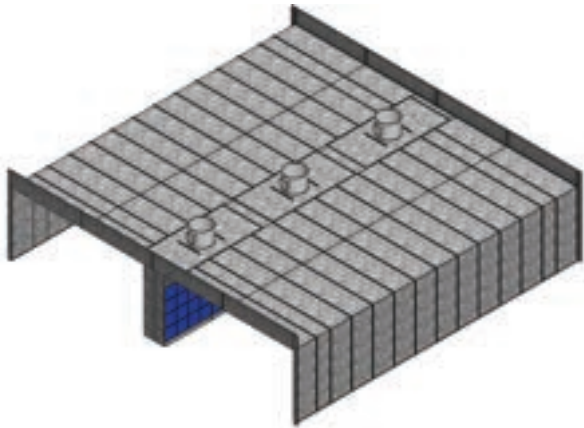

40x40x9 - Two Booths



Inside Dimensions:
36' Wide x 40' Long x 9' High



Outside Dimensions:
41' Wide (the front support makes the booth wide in the front only)
40' 4" Long (the body of the spray booth)
11' High (2' for the header)

Booth Specifications:

- (20) 4 Tube LED T8 light fixtures
- (3) 30" Diameter Tubeaxial belt drive exhaust fan
- (3) 3hp 3ph motor 208-230/460v. 60 hz
- (192) Exhaust filters with (192) exhaust filter grids
- (1) Hardware set for assembly

OPTION: (3) 3hp motor, **single-phase**, 1,740 RPM, 115/230V AC, 184T

Working Dimensions:

36' Wide (4' for the Plenum) x 40' Long x 9' High

Fast Rack Equipment Large Industrial Double-Sided Plenum with LED lighting is great for the light and heavy industrial companies. These two booths allow several finishers to be spraying at the same time, creating a superior finish and an ideal working environment for the finishers.

Our spray booths are all made from 18-gauge galvanized steel and comply with NFPA-33 standards for spray application using flammable or combustible materials. Our electrical components are UL Certified to meet nationally recognized safety and sustainability standards.

The Fast Rack Equipment team is here to assist you in choosing one of our standard spray booths or creating the perfect custom spray booth with the help of our engineers.

“Your Spray Booth Finishing Solutions”



Filter Wall - 20x100

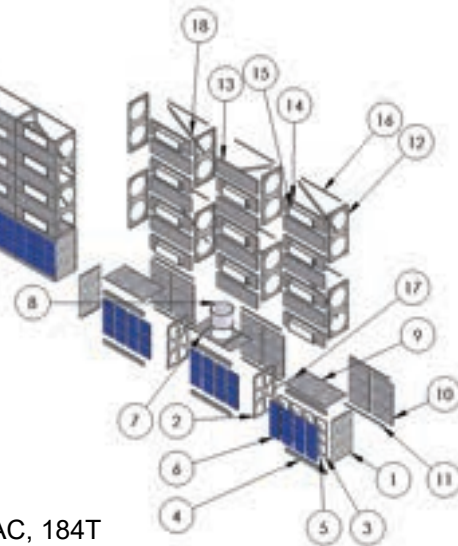
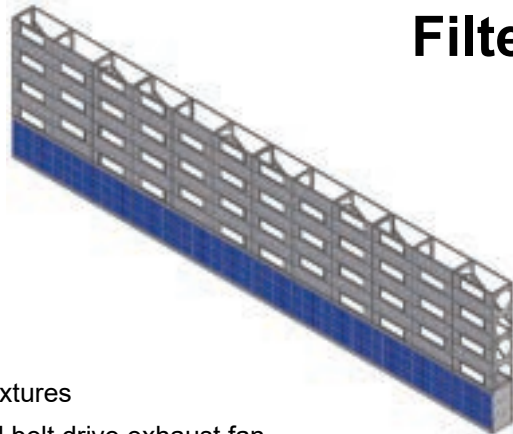

Plenum Specifications:

- (55) 4 Tube LED T8 light fixtures
- (5) 30" Diameter Tubeaxial belt drive exhaust fan
- (3) 3hp 3ph motor 208-230/460v. 60 hz
- (180) Exhaust filters with (180) exhaust filter grids
- (1) Hardware set for assembly

OPTION: (1) 3hp motor, **single-phase**, 1,740 RPM, 115/230V AC, 184T



Fast Rack Equipment Large Industrial Free Standing Plenum with wall of LED lights is ideal for light and heavy industrial companies. These walls turn rooms into finishing areas and a healthy environment for the finishers.

Our large industrial free standing plenums are all made from 18-gauge galvanized steel and comply with NFPA-33 standard for spray application using flammable or combustible materials. Our electrical components are UL Certified to meet nationally recognized safety and sustainability standards.

The Fast Rack Equipment team is here to assist you in choosing one of our standard plenums or creating the perfect custom plenum with the help of our engineers.

“COME SPRAY WITH US!”



Spray Booth Accessories

WALL BOOTH COATING . . . protect your walls and ceilings!

White Booth Coating
5 Gallon

Part Number: FRE-Coat

Fast drying, water reducible acrylic latex coating intended for industrial product finishing and refinishing applications. The product is optimized to provide a balance between performance and value in the general metal finishing marketplace.

FLOOR BOOTH COATING . . . protect your floors!

3M Dirt Trap Material Floor Dispenser
28 ft Wide

Part Number: FRE-DTP28



3M Dirt Trap Protection Material
Extra Heavy Duty
18 mil Thick, 300 ft Long x 28 in Wide, White

Part Number: FRE-DT28

SPRAY BOOTH FILTERS



Booth Filters
20x20x1
Fiberglass, Blue/White
Part Number: FRE-48FLTR