

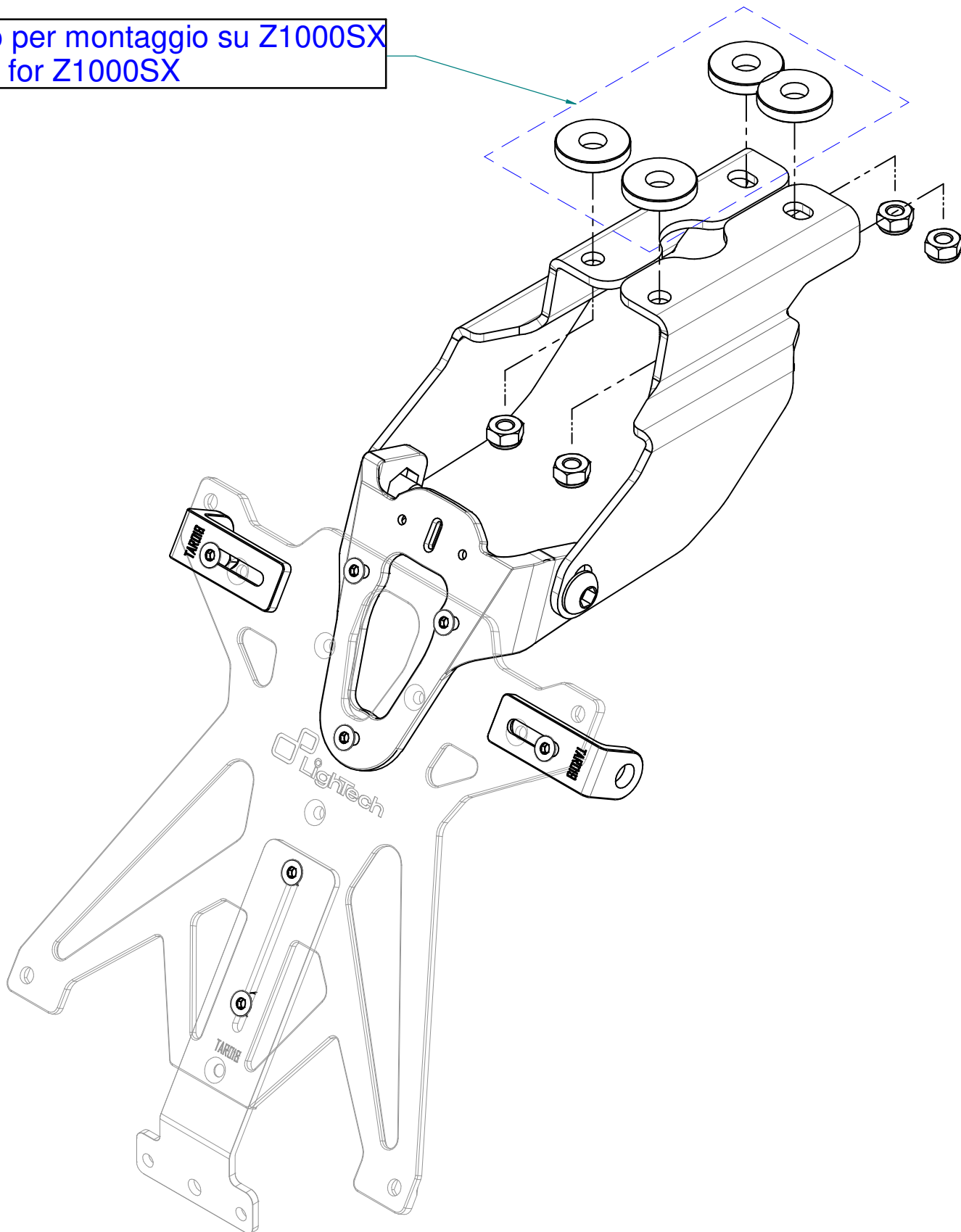

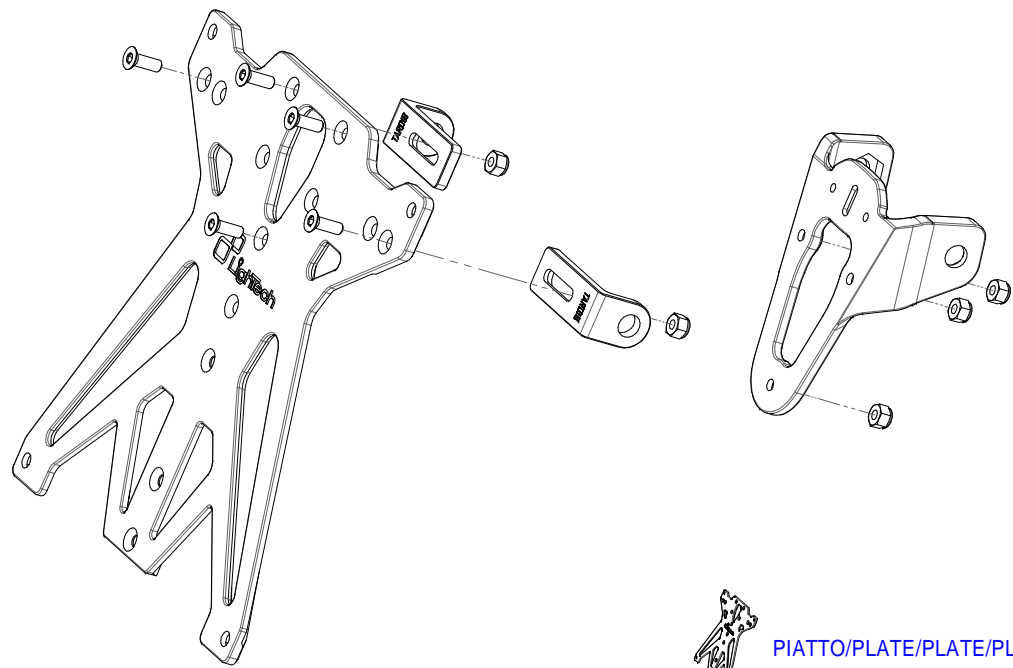



Usare solo per montaggio su Z1000SX  
Using only for Z1000SX



IT) E' necessario l'intervento di personale professionale per tutti i prodotti che necessitano di installazione.  
 EN) The assistance of professional staff is necessary for all parts which require installation.  
 ES) Se necesita que sea montado por profesionales para todos los productos que necesitan instalación.  
 FR) L'assistance d'un professionnel est nécessaire pour toutes les pièces qui nécessitent une installation.  
 DEU) Der Eingriff von Fachpersonal ist notwendig für alle Artikel die installiert/montiert werden müssen.



-  PIATTO/PLATE/PLATE/PLAQUE -- (1pz)
-  STAFFA/BRACKET/BRACKET/SUPPORT -- (1pz)
-  STAFFA FRECCHE AFTERMARKET  
AFTERMARKET INDICATOR BRACKET/  
BRACKET/SUPPORT -- (2pz)
-  VITE/SCREW/SCHRAUB/VIS -- M4x12 UNI5933 (5+2pz)
-  DADO AUTOBL./SELF-LOCKING NUT/SELBSTSICHERNDE MUTTER/  
ÉCROU AUTO-BLOQUANT -- M4 (5+2pz)

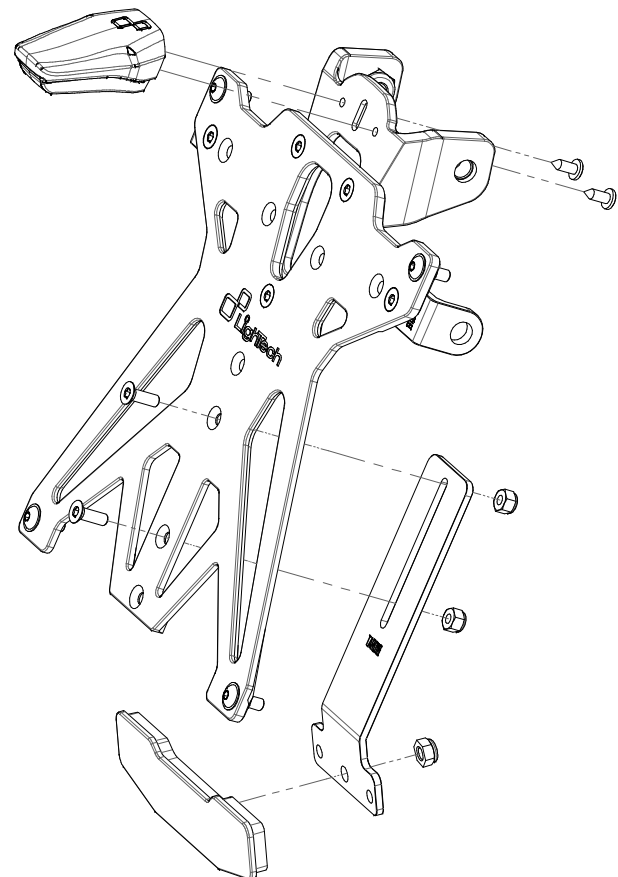
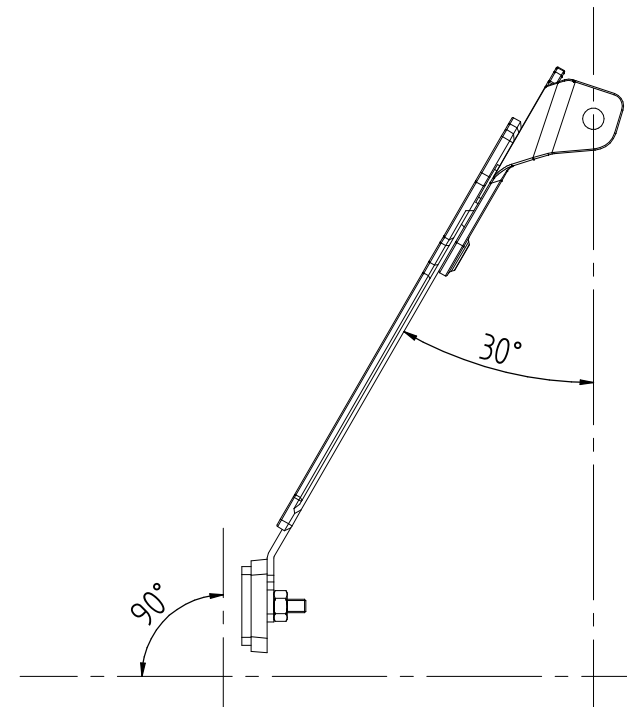





N.2 Led Rossi  
N.2 Red Led

N.4 Led Bianchi  
N.4 White Led

Colore	Connessione
Nero	Massa
Rosso	N. 4 Led Bianchi luce targa
Bianco	N. 2 Led Rossi (Luce di Posiz. oppure stop)

Color	Connection
Black	Ground
Red	N. 4 White Led (plate number light)
White	N. 2 Red Led (Position or stop)

-  LUCE TARGA/LICENSE PLATE LIGHT -- (1pz)
-  VITE/SCREW/SCHRAUB/VIS -- UNI6955-AB 2,9x16 (2pz)
-  STAFFA/BRACKET/BRACKET/SUPPORT -- (1pz)
-  CATADIOTTRO -- (1pz)
-  DADO/NUT/MUTTE -- M5 (1pz)

- IL CODICE DELLA STRADA (ART. 259) FISSA LE MODALITA' DI INSTALLAZIONE DELLE TARGHE DI CUI A SEGUITO SI RIPORTANO I PUNTI FONDAMENTALI :  
 - SE LA FORMA DEL VEICOLO LO RICHIEDE LA TARGA PUO' ESSERE INCLINATA ALL'INDIETRO DI 30° RISPETTO ALLA VERTICALE.  
 - SE LA TARGA A CAUSA DEL SUO IRREGOLARE POSIZIONAMENTO , RISULTA ILLEGGIBILE CONCORRE L'IPOTESI DELL' ART. 102 c.7

- LA LIGHTTECH srl NON SI ASSUME RESPONSABILITA' PER UTILIZZI NON A NORMA CON IL CODICE STRADALE  
 - DISEGNO GENERICO , A SECONDA DEL PAESE DI UTILIZZO PARTICOLARI NON NECESSARI SARANNO ESCLUSI DALLA CONFEZIONE

- ADJUSTING THE ANGLE PLATE UNDER THE CODE IN FORCE IN THE COUNTRY IN USE  
 - LIGHTTECH LTD WILL NOT ASSUME ANY RESPONSIBILITY ' FOR USE NOT IN ACCORDANCE WITH THE TRAFFIC RULES  
 - GENERIC DRAWING ,DEPENDING ON THE COUNTRY OF USE, SOME PARTS COULD BE DIFFERENT IN THE SHAPE OR COULD BE EXCLUDED IN THE PACKAGING

- EISTELLEN DEN NEIGUNGSWINKEL NACH DEN REGELN DES TRAFFIC KODES DES NUTZUNGLANDS.  
 - LIGHTTECH SRL ÜBERNIMMT KEINE VERANTWORTUNGEN FÜR DIE NUTZUNG NICHT IN ÜBEREINSTIMMUNG MIT DEM TRAFFIC KODE.  
 - GENERISCHE ZEICHNUNG.JE NACHDEM NUTZUNGLAND, KöNNEN EIGENE KOMPONENTEN IM FORMBLATT ÄNDERN, ODER AUS DER PACKUNG AUSGESCHLOSSEN WERDEN

- REGLER L'INCLINATION SUPPORT DE PLAQUE EN BAS AU CODE EN VIGUER DANS LA NATION EN USAGE  
 - LIGHTTECH SRL N'ASSUME PAS AUCUNE RESPONSABILITE' POUR UTILISATION PAS à NORME AVEC LE CODE DE LA ROUTE.  
 - DESSIN GÉNÉRIQUE. SELON LE PAYS D'UTILISATION, CERTAINS COMPOSANTS POURRAIENT ÊTRE DIFFÉRENTS OU EXCLUS DE L'EMBALLAGE.