



B O R N T O B E M O T O

PEDANE - REAR SETS - ESTRIBERAS - FUSSRASTENANLAGEN - ステップ キット

- 10 regolabili - adjustable - regulables - Fussrastenanlage - アジャスタブル
60 componenti ricambio - spare parts - componentes de recambio - Ersatzteile - スペア パーツ
70 poggiapiedi - footpegs - estribo - Rasten - ステップ バー

TENDITORI CATENA - CHAIN ADJUSTERS - TENSOR CADENA - KETTENSPANNER - チェーン アジャスター

- 74 tenditori catena - chain adjusters - tensor cadena - Kettenspanner - チェーン アジャスター
83 supporti cavalletto - swing arm spools - soportes caballete - Träger für Ständeraufnahme - スイングアーム スプール

PORTA TARGA - LICENSE PLATE HOLDERS - PORTAMATRICULA - KENNZEICHENHALTER - ナンバー ホルダー

- 86 regolabili - adjustable - regulables - Verstellbare Kennzeichenhalter - アジャスタブル

LUCI - LIGHTS - LUCES - BELEUCHTUNG - ライト

- 100 luci - lights - luces - Beleuchtung - ライト

LEVE - LEVERS - MANETAS - BREMS UND KUPPLUNGSHEBEL - レバー

- 112 kit leve - levers kit - kit manetas - kit klappbare Hebel - レバー キット
115 leve freno/frizione - brake/clutch levers - manetas de freno/embrague - Bremshebel- Kupplungshebel - ブレーキ・クラッチレバー
120 ricambi leve - levers spare parts - recambios de manetas - Ersatzteile - レバー スペア パーツ

PROTEZIONI LEVE - LEVERS PROTECTIONS - PROTECCIÓN DE MANETA - HEBELPROTEKTOR - レバー プロテクター

- 124 protezioni leve - levers protections - protección de maneta - Hebelprotektor - レバー プロテクター

BRACCIALI MANUBRIO E PIASTRE DI STERZO - CLIP-ONS AND TRIPLE CLAMP - SOPORTES MANILLAR Y PLACA TIJA SUPERIOR LENKERSCHELLEN UND PLATTE FÜR LENKUNG - セパレートハンドル - トップブリッジ

- 132 piastre di sterzo - triple clamp - placa tija superior - Platte für Lenkung - トップブリッジ
134 bracciali manubrio e tubi - clip-ons and handlebar tubes - soportes y tubo manillar
Lenkerschellen und Lenkerstummel - セパレートハンドル バー

ACCESSORI MANUBRIO - HANDLEBAR ACCESSORIES - ACCESORIOS PARA MANILLAR - ZUBEHÖR FÜR LENKER - ハンドル アクセサリー

- 140 contrappesi manubrio - handle bar balancers - contrapesos manillar - Lenkergewichte - ハンドルバー ウェイト

TAPPI SERBATOIO - FUEL TANK CAPS - TAPÓN DEPÓSITO - TANKDECKEL - フューエル タンク キャップ

- 148 tappi serbatoio - fuel tank caps - tapón depósito - Tankdeckel - フューエル タンク キャップ
153 serbatoio olio freno e frizione - fluid tank for brake and clutch - depósito liquido freno y embrague
Brems/Kupplungsöl Tankdeckel - ブレーキ・クラッチ用 オイルタンク

TAPPI OLIO - CAPS - TAPÓN - VERSCHLÜSSE - キャップ

- 156 tappi olio - oil filler caps - tapón aceite - Ölverschlussschraube - オイルフィルターキャップ
158 coperchi pompe freno e frizione - clutch/brake pump reservoir covers - tapas bomba freno y depósito embrague hidráulico
Bremspumpe und Kupplungsdeckel - クラッチ・ブレーキ オイルリザーバカバー

PROTEZIONI - PROTECTIONS - PROTECCIONES - PROTEKTOREN - プロテクション

- 164 protezioni telaio - frame sliders - protecciones carenado - Rahmenprotektoren - フレーム スライダー
169 ricambi protezioni telaio - frame slider spare parts - ecambio protecciones carenado
Ersatzteile für Protektoren - フレーム スライダースペアパーツ

**PROTEZIONI PERNI RUOTA - WHEEL AXLE SLIDERS - PROTECCIONES TUERCA RUEDA
RADACHSE PROTEKTOREN - ホイール アクスル スライダー**

172 protezioni perni ruota - wheel axle sliders - protecciones tuerca rueda - Radachse Protektoren - ホイール アクスル スライダー

**PROTEZIONI IN ALLUMINIO - ALUMINIUM PROTECTIONS - PROTECTORES EN ALUMINIO
ALUMINIUM PROTEKTOREN - アルミニウム プロテクション**

176 protezioni in alluminio - aluminium protections - protectores en aluminio - Aluminium Protektoren - アルミニウム プロテクション

TAPPI SPECCHIO - MIRROR BLOCK-OFF PLATES - TAPÓNES ESPEJOS - SPIEGEL ABDECKUNG - ミラー ブラインド プレート

190 tappi specchio colorati - coloured mirror block-off plates - tapónes espejos de colores - farbige Spiegel Abdeckungen - ミラー ブラインド プレート

SPECCHI - MIRRORS - RETROVISORES - SPIEGEL - ミラー

194 in alluminio - aluminium mirrors - en aluminio - Aluminium - アルミニウム ミラー

VITERIA - BOLTS - TORNILLERIA - SCHRAUBEN - ボルト・スクリュー

198 ergal 7075
200 titanio - titanium - titanio - Titan Schrauben - チタン
202 special ergal 7075
204 forate - drilled - agujereados - Gelochte Schrauben - ドリルドスクリュー
204 ergal 7075 autofilettanti - self tapping bolts - rosca chapa - Selbstschneidende Schrauben - タッピング スクリュー ジュラルミン 7075
204 ganci rapidi e ricettacoli - quick fairing and receptacles - tornillos rapidos y soporte tornillo rapido - Schnellverschluss Schrauben - クイック ファスナー
206 dadi e rondelle - nuts and washers - tuercas y arandelas - Muttern Schrauben und Unterlegscheiben Schrauben - ナット・ワッシャー
208 viti dischi freno in titanio - bolts for brake disk in titanium - tornillos para disco freno en titanio
Spezialschrauben für Bremsscheiben Schrauben - チタン ブレーキディスク ボルト

KIT VITI - BOLTS KIT - KIT TORNILLERIA - SCHRAUBEN SETS - ボルト キット

210 kit viti - bolts kit - kit tornilleria - Schrauben Sets - ボルト キット

DADI SPECIAL - SPECIAL NUTS - TUERCAS ESPECIALES - SPEZIALMUTTERN - スペシャル ナット

214 dadi special - special nuts - tuercas especiales - Spezialmuttern - スペシャル ナット

COMPONENTI IN CARBONIO - CARBON PARTS - COMPONENTES EN CARBONO - CARBON - カーボン パーツ

218 componenti in carbonio - carbons parts - componentes en carbono - Carbon-Komponenten - カーボン パーツ

GRIGLIE RADIATORE - RADIATOR GUARDS - PROTECTORES DE RADIADOR - KÜHLERSCHUTZGITTER - ラジエーター ガード

234 griglie radiatore - radiator guards - protectores de radiador - Kühlerschutzgitter - ラジエーター ガード

CAVALLETTI - STANDS - CABALLETES - STÄNDER - スタンド RACING & BOX

238 cavalletti - stands - caballetes - Ständer - スタンド
245 accessori box - box accessories - accesorios box - Zubehör für box - ボックス アクセサリー
248 saponette - knee sliders - deslizadores - Knieschleifer - ニー スライダー

252 APPAREL by Lightech

ITALIAN RACING COMPONENTS

Nel 1997, Fabrizio Furlan crea LighTech per portare le competenze produttive della sua famiglia e della sua professione di pilota nell'eccitante mondo delle moto da corsa. Collaborare con prestigiosi team nel **Campionato Mondiale Superbike, Moto GP, Moto 2GP e 125 GP** ha permesso a LighTech di sviluppare e diventare leader nel campo degli accessori per moto.

In 1997, Fabrizio Furlan created LighTech to bring his family's manufacturing expertise to the exciting world of motorcycle racing. Working closely with elite teams in the **World Superbike Championship, Moto GP, 125 GP and Moto 2GP** has allowed LighTech to become a leader of technologically advanced motorcycle performance parts and accessories.

In 1997 gründete Fabrizio Furlan die Firma LighTech um seiner Familie die aufregende Welt des Motorradsports näher zu bringen. In enger Zusammenarbeit mit Elite-Teams in der **Superbike-WM, Moto GP, 125 GP und Moto 2** konnte LighTech zu einem der führenden Hersteller von technologisch fortschrittlichsten Performance-Teilen und Zubehör werden.

En 1997, Fabrizio Furlan crea LighTech para combinar la fuerza productiva de la empresa familiar y la experiencia de su profesión como piloto en el excitante mundo de las carreras. Colabora con los mejores equipos del **Campeonato Mundial de Superbike, Moto GP, Moto2 Y 125 GP** ha permitido a LighTech de desarrollar y convertirse en líder en el campo de accesorios de moto.

1997年に、イタリア人Fabrizio Furlanは、先代から受け継ぐ精密部品製造ノウハウを武器に LighTech ブランドを立ち上げ、エキサイティングなオートバイレースの世界に身を投じました。頻繁にサーキット場にも足を運び、**MotoGPを始めとする世界最高峰ロードバイク選手権GP125・Moto2・WSBK**のトップチームと信頼関係を構築し、部品供給を開始しました。そして、そこで得た高度な技術を、LighTech が製造するパーツに惜しみなく採用することにより、イタリアオートバイパーツ&アクセサリーのリーダー的存在になることができました。

EFFICIENTAMENTO ENERGETICO DELL'IMPRESA LIGHTECH SRL



Un'opportunità di opportunità. Da non lasciarsi sfuggire.

Descrizione degli interventi realizzati:

- Diagnosi energetica della struttura produttiva edificio-impianto;
- Installazione impianto solare fotovoltaico di potenza 123,69kWp;
- Relamping parziale con installazione di corpi illuminanti sostitutivi a LED;
- Installazione centro di lavoro CNC sostitutivo ad elevata efficienza energetica.

Intervento realizzato avvalendosi del finanziamento
POR - Obiettivo "Investimenti a favore della crescita e dell'occupazione"
Parte FESR fondo europeo di sviluppo regionale 2014-2020.



ASSE	AZIONE
4	4.2.1



Certificato

CERTIFICATE - CERTIFICADO - ZERTIFIKAT - 証明書



Nr. 50 100 3736 Rev. 006

UNI EN ISO 9001:2015





BORN TO BE MOTO

Oggi, LighTech si sviluppa su una superficie di 2.500 metri quadrati, così suddivisi: 1.400 dedicati alla produzione con sofisticati torni e frese a controllo numerico (CNC), 600 all'area magazzino e stoccaggio, 50 al dipartimento Ricerca e Sviluppo in cui gli ingegneri utilizzano programmi di disegno tecnico (CAD) e produzione (CAM) assistiti da computer per progettare.

Today, the LighTech factory houses 2,500 square meters of which 1,400 dedicated to production with sophisticated computer-numeric-control (CNC) machines, 600 to storage area and 50 to research and development department where engineers use state-of-the-art computer-assisted design (CAD) and computer-assisted manufacturing (CAM) programs.

Heute ist die Fabrik von LighTech 2.500 Quadratmetern groß, von denen 1.400 m² auf die Produktion mit Computer-numeric-Steuerung (CNC) Maschinen entfallen, 600 m² Lagerfläche und 50m² für die Forschungs-und Entwicklungsabteilung, wo Ingenieure Computer- Aided Design (CAD) und computergestützte Fertigung (CAM)-Programme nutzen.

LighTech trabaja en sus instalaciones de 2500 metros cuadrados divididos de la siguiente manera: 1400 m² dedicados a la producción con sofisticados tornos y fresas de control numérico (CNC), 600 m² de almacén y stock, 50 m² del departamento de I+D, donde los ingenieros usan el programa de diseño técnico CAD y de producción CAM.

LighTech ファクトリーの総敷地面積は、2500㎡を誇り、うち、最先端CNCフライスマシンなどを擁する生産用工場敷地面積1400㎡、製品倉庫600㎡、そして、50㎡の施設は、研究開発部門において、エンジニア達が最先端のCAD・CAMプログラミングをするために使用されております。

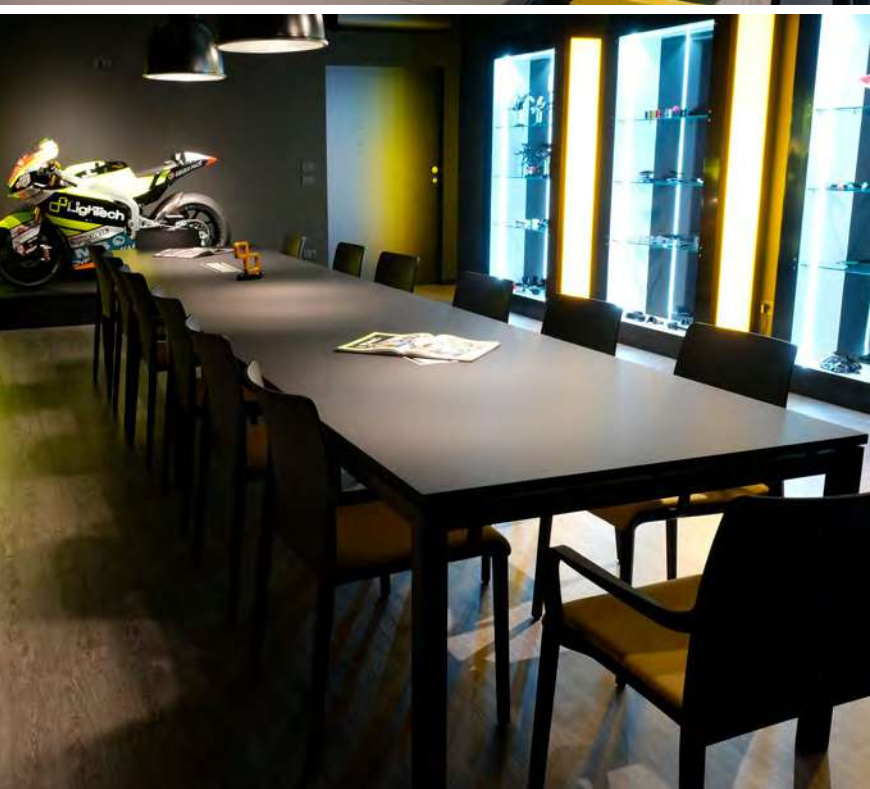
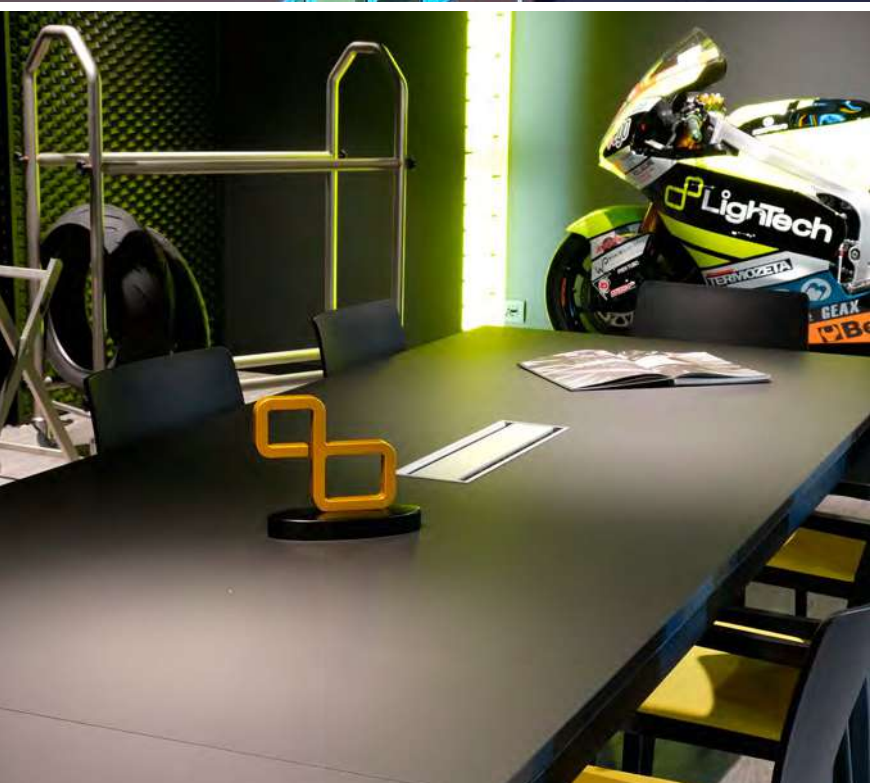

THE CATALOG

Il catalogo LighTech contiene **più di 7.000 prodotti in Ergal** che sono realizzati in diverse colorazioni, **400 prodotti in titanio** ed una serie di numerosi altri accessori. LighTech può contare su di una rete vendita strutturata attualmente in oltre **1.500 rivenditori autorizzati in Italia e distributori in 50 altri paesi**. Tale rete è in continuo ampliamento.

The scope of LighTech is enormous. The LighTech catalog contains **over 7,000 ergal products** that are manufactured in seven different colours, over **400 titanium products** and a host of other accessories. LighTech has **more than 1,500 authorized dealers in Italy and distributors in 50 countries**.

El catalogo de LighTech contiene **mas de 7000 productos en Ergal** que se anodizan en diferentes colores, **400 productos en titanio** y una larga lista de accesorios. LighTech cuenta con una red de ventas perfectamente estructurada en **mas de 1500 revendedores autorizados en Italia y distribuidores en 50 países**. Todo esto en continuo crecimiento.

Der Produktionsumfang von LighTech ist sehr vielfältig. Der Katalog enthält **über 7.000 Ergal Aluminium Produkte**, die in sieben verschiedenen Farben hergestellt werden, **über 400 Titan-Produkte** und viele andere Accessoires. LighTech hat **mehr als 1.500 autorisierte Händler in Italien und Distributoren in 50 Ländern**.

LighTech社で生産される製品ラインナップはとても膨大です。LighTech のカタログには、7つのカテゴリーに分け、7,000種類以上のジュラルミン製品、400種類以上のチタン製品やその他の付属品パーツを掲載しております。ぜひこのカタログをご活用ください。



RACING TEAM



Anni di sponsorizzazioni tecniche, l'utilizzo di un design e metodi di produzione all'avanguardia e la passione per la moto da corsa, sono le ragioni per cui si trovano qualità e innovazione in ogni prodotto Lighttech.

Years of technical sponsorship, the use of cutting edge design and production methods and a passion for motorcycle racing are the reasons why you will find quality and innovation in every LightTech product. You can definitely believe that.

Años de sponsorización técnica, el uso del diseño y método de producción en la vanguardia, la pasión por la moto de carreras, es la razón por la cual se encuentra la innovación en cada producto de Lighttech.

Jahrelange Erfahrung im technischen Sponsoring, sowie der Einsatz modernster Konstruktions- und Fertigungsmethoden plus der Leidenschaft für Motorradrennen sind die Gründe dafür, dass Sie Qualität und Innovation in jedem Lighttech Produkt wiederfinden. Das können Sie uns glauben.

レーシングチームへのテクニカルスポンサーシップは、最先端デザインおよび製造方法の習得と鍛錬のために、そして私たちのオートバイレースへの情熱の証と考えております。その証は、すべてのLightTech製品に品質と革新の精神を見つけることができます。また同時に、それは製品に対する信頼を、ユーザー様にお届け出来ると信じております。

TECHNICALSPONSOR2024

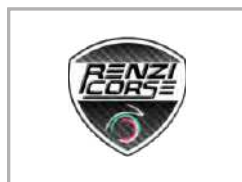





PEDANE

REAR SETS

ESTRIBERAS

FUSSRASTENANLAGEN

ステップキット

LIGHTTECH NEW REAR SETS

Tutte le pedane LighTech sono progettate e realizzate al 100% nel nostro stabilimento.

All LighTech rear sets are designed and manufactured 100% in our factory.

Todas las estriberas LighTech están 100% diseñadas y fabricadas en nuestra fábrica.

Alle LighTech-Fußrastenanlage werden zu 100% in unserer Fabrik entwickelt und hergestellt.

Lighttech製のステップキットは100%自社工場で生産されています



STANDARD

STANDARD REAR SET CONFIGURATION:

Poggiapiedi fissi, puntalini fissi, paratacchi in composito

Fixed footpegs, fixed toe pegs, composite heel guards

Estribo fijo y puntera fija, protector en composite/polimero

Nicht klappbare Rasten, Schaltspitze, Fersenschutz aus Kompositmaterial

スタンダードバージョンのステップキットでは、固定式のステップバーとトゥーペグ、マグネシウム製ヒールガード(複合素材)

WVERSION

W REAR SET CONFIGURATION:

Poggiapiedi pieghevoli, puntalini fissi, paratacchi in composito

Folding footpegs, fixed toe pegs, composite heel guards

Estribo abatible, puntera fija, protector en composite/polimero

Klappbare Rasten, Schaltspitze, Fersenschutz aus Kompositmaterial

"W"バージョンのステップキットでは、可倒式ステップバー、固定式トゥーペグ、マグネシウム製ヒールガード(複合素材)



W

RVERSION

R REAR SET CONFIGURATION:

Poggiapiedi pieghevoli, puntalini pieghevoli, paratacchi in carbonio, viti in titanio, piastrine rosse

Folding footpegs, folding toe pegs, carbon heel guards, titanium screws, red footpeg holders

Estribo abatible, puntera abatible, protector en carbono, tornillerai en titanio, soportes en rojo

Klappbare Fußrasten, Gelenkschaltspitze, Carbon-Fersenschutz, Titanschrauben, rote Träger für Rasten

"R"バージョンのステップキットでは、可倒式のステップバーとトゥーpeg、カーボン製ヒールガード、チタン製ボルト、赤いステップバーホルダーが標準装備です。



RFTR244

Kit piastrine up&down permettono un ulteriore ampliamento delle regolazioni

"Up & Down" footpeg holders kits allow further expansion of the adjustments

Kits de soportes up&down permiten una mayor regulacion

"Up & Down" Kit Halterung für die Raste ermöglichen eine weitere Erweiterung der Einstellungen

アップ&ダウンステップバーホルダーキット(品番: RFTR244)を使用することで、さらに上下にポジション調整が可能になります。



silver



black



cobalt



red

PEDANE REGOLABILI

ADJUSTABLE REAR SETS - ESTRIBERAS REGULABLES - FUSSRASTENANLAGEN - アジャスタブル ステップ キット

APRILIA

**RS 660
TUONO 660**

Year: 20 - 24

TÜV homologated

Shifting: standard - reverse

Poggiapiede fisso
Fixed footpeg
Cojinete y pedal fijo
Mit nicht klappbarer Rasten
固定式 ステップバー

FTRAP007

Poggiapiede snodato
Fold up footpeg
Cojinete y pedal abatible
Auf Kugellager mit klappbaren Rasten
可倒式 ステップバー

FTRAP007W

"R" version

FTRAP007R

Compatible with RFTR244

YES



KBA 90967

Con modelli moto **EURO 4**, le pedane acquistate per uso stradale devono essere tassativamente equipaggiate con poggiatepiù pieghevoli come previsto dall'ABE - With **EURO 4** motorcycle models, the rearsets purchased for street use must be strictly equipped with folding footpegs as required by the ABE - Con la moto **EURO4** la estribera para uso de calle debe llevar obligatoriamente el estribo abatible como previsto norma ABE - Für die Nutzung der Fussrastenanlage im öffentlichen Straßenverkehr ab Modelle mit **E4** sind klappbare Rasten erforderlich.

RSV4 RF / RR / 1100 FACTORY TUONO V4 / 1100 FACTORY

Year: 18 - 24

TÜV homologated

Shifting: standard

Poggiapiede fisso
Fixed footpeg
Cojinete y pedal fijo
Mit nicht klappbarer Rasten
固定式 ステップバー

FTRAP005



Poggiapiede snodato
Fold up footpeg
Cojinete y pedal abatible
Auf Kugellager mit klappbaren Rasten
可倒式 ステップバー

FTRAP005W

"R" version

FTRAP005R

Shifting: reverse

Poggiapiede fisso
Fixed footpeg
Cojinete y pedal fijo
Mit nicht klappbarer Rasten
固定式 ステップバー

FTRAP006



Poggiapiede snodato
Fold up footpeg
Cojinete y pedal abatible
Auf Kugellager mit klappbaren Rasten
可倒式 ステップバー

FTRAP006W

"R" version

FTRAP006R

Compatible with RFTR244

YES



KIT conversione cambio da standard a rovesciato per modello FTRAP005-W-R
Conversion kit standard to reverse shift for p/n FTRAP005-W-R
Kit de conversión cambio estándar a invertido para mod. FTRAP005-W-R
Kit Schaltbildänderung von Standard in Reverse für Mod. FTRAP005-W-R
FTRAP005-W-R用 逆シフトチェンジレバー (正→逆)

RFTR290



KIT conversione cambio da rovesciato a standard per modello FTRAP006-W-R
Conversion kit reverse to standard shift for p/n FTRAP006-W-R
Kit de conversión cambio invertido e estándar para mod. FTRAP006-W-R
Kit Schaltbildänderung von Reverse in Standard für Mod. FTRAP006-W-R
FTRAP006-R-W用 変換キット (逆⇒正)

RFTR291

KBA 90967

Con modelli moto **EURO 4**, le pedane acquistate per uso stradale devono essere tassativamente equipaggiate con poggiapiedi pieghevoli come previsto dall'ABE - With **EURO 4** motorcycle models, the rearsets purchased for street use must be strictly equipped with folding footpegs as required by the ABE - Con la moto **EURO4** la estribera para uso de calle debe llevar obligatoriamente el estribo abatible como previsto norma ABE - Für die Nutzung der Fussrastenanlage im öffentlichen Straßenverkehr ab Modelle mit **E4** sind klappbare Rasten erforderlich.

PEDANE REGOLABILI

ADJUSTABLE REAR SETS - ESTRIBERAS REGULABLES - FUSSRASTENANLAGEN - アジャスタブル ステップ キット

APRILIA

RSV4

Year: 09 - 17

TÜV homologated

TUONO V4

Year: 11 - 17

TÜV homologated

Shifting: standard

Poggiapiede fisso

Fixed footpeg

Cojinete y pedal fijo

Mit nicht klappbarer Rasten

固定式 ステップバー

FTRAP004

Poggiapiede snodato

Fold up footpeg

Cojinete y pedal abatible

Auf Kugellager mit klappbaren Rasten

可倒式 ステップバー

FTRAP004W

"R" version

FTRAP004R

Compatible with RFTR244

NOT



KIT conversione cambio da standard a rovesciato per modello FTRAP004-W-R

Conversion kit standard to reverse shift for p/n FTRAP004-W-R

Kit de conversión cambio estándar a invertido para mod. FTRAP004-W-R

Kit Schaltbildänderung von Standard in Reverse für Mod. FTRAP004-W-R

FTRAP004-W-R用 逆シフトチェンジレバー (正→逆)

RFTR236

KBA 90967

Con modelli moto **EURO 4**, le pedane acquistate per uso stradale devono essere tassativamente equipaggiate con poggiapiedi pieghevoli come previsto dall'ABE - With **EURO 4** motorcycle models, the rearsets purchased for street use must be strictly equipped with folding footpegs as required by the ABE - Con la moto **EURO4** la estribera para uso de calle debe llevar obligatoriamente el estribo abatible como previsto norma ABE - Für die Nutzung der Fussrastenanlage im öffentlichen Straßenverkehr ab Modelle mit **E4** sind klappbare Rasten erforderlich.

BMW

M1000RR

Year: 22 - 24

TÜV homologated

S1000R

Year: 21 - 24

TÜV homologated

Shifting: standard - reverse

Poggiapiede fisso
Fixed footpeg
Cojinete y pedal fijo
Mit nicht klappbarer Rasten
固定式 ステップバー

FTRBM008

Poggiapiede snodato
Fold up footpeg
Cojinete y pedal abatible
Auf Kugellager mit klappbaren Rasten
可倒式 ステップバー

FTRBM008W

"R" version

FTRBM008R

Compatible with RFTR244

YES

**NEW
DESIGN**



KBA 90967

Con modelli moto **EURO 4**, le pedane acquistate per uso stradale devono essere tassativamente equipaggiate con poggiapiedi pieghevoli come previsto dall'ABE - With **EURO 4** motorcycle models, the rearsets purchased for street use must be strictly equipped with folding footpegs as required by the ABE - Con la moto **EURO4** la estribera para uso de calle debe llevar obligatoriamente el estribo abatible como previsto norma ABE - Für die Nutzung der Fussrastenanlage im öffentlichen Straßenverkehr ab Modelle mit **E4** sind klappbare Rasten erforderlich.

PEDANE REGOLABILI

ADJUSTABLE REAR SETS - ESTRIBERAS REGULABLES - FUSSRASTENANLAGEN - アジャスタブル ステップ キット

BMW

S1000RR

Year: 19 - 24

TÜV homologated

M1000RR

Year: 21 - 24

TÜV homologated

Shifting: standard - reverse

PoggiapiEDE fisso

Fixed footpeg

Cojinete y pedal fijo

Mit nicht klappbarer Rasten

固定式 ステップバー

FTRBM007

PoggiapiEDE snodato

Fold up footpeg

Cojinete y pedal abatible

Auf Kugellager mit klappbaren Rasten

可倒式 ステップバー

FTRBM007W

"R" version

FTRBM007R

Compatible with RFTR244

YES



Supporto leva cambio per uso racing (senza cavalletto laterale)

Gear lever support for race use (without side stand)

Soporte pedal de cambio uso racing (sin caballete lateral)

Halterung für Schaltstange - Racing (ohne Seitenständer)

レース用 ギアレバー サポート (サイドスタンド使用不可)

Year: 19 - 23

FTR840NER

KBA 90967

Con modelli moto **EURO 4**, le pedane acquistate per uso stradale devono essere tassativamente equipaggiate con poggiapiEDE pieghevoli come previsto dall'ABE - With **EURO 4** motorcycle models, the rearsets purchased for street use must be strictly equipped with folding footpegs as required by the ABE - Con la moto **EURO4** la estribera para uso de calle debe llevar obligatoriamente el estribo abatible como previsto norma ABE - Für die Nutzung der Fussrastenanlage im öffentlichen Straßenverkehr ab Modelle mit **E4** sind klappbare Rasten erforderlich.

BMW

S1000R

Year: 17 - 20

TÜV homologated

S1000RR / HP4

Year: 15 - 18

TÜV homologated

Shifting: standard - reverse

Poggiapiede fisso
Fixed footpeg
Cojinete y pedal fijo
Mit nicht klappbarer Rasten
固定式 ステップバー

FTRBM004

Poggiapiede snodato
Fold up footpeg
Cojinete y pedal abatible
Auf Kugellager mit klappbaren Rasten
可倒式 ステップバー

FTRBM004W

"R" version

FTRBM004R

Compatible with RFTR244

NOT



KBA 90967

PEDANE REGOLABILI

ADJUSTABLE REAR SETS - ESTRIBERAS REGULABLES - FUSSRASTENANLAGEN - アジャスタブル ステップ キット

BMW

S1000R

Year: 14 - 16

TÜV homologated

S1000RR / HP4

Year: 09 - 14

TÜV homologated

Shifting: standard

Poggiapiede fisso

Fixed footpeg

Cojinete y pedal fijo

Mit nicht klappbarer Rasten

固定式 ステップバー

FTRBM001

Poggiapiede snodato

Fold up footpeg

Cojinete y pedal abatible

Auf Kugellager mit klappbaren Rasten

可倒式 ステップバー

FTRBM001W

"R" version

FTRBM001R

Compatible with RFTR244

YES



KIT conversione cambio da standard a rovesciato per modello FTRBM001-W-R

Conversion kit standard to reverse shift for p/n FTRBM001-W-R

Kit de conversión cambio estándar a invertido para mod. FTRBM001-W-R

Kit Schaltbildänderung von Standard in Reverse für Mod. FTRBM001-W-R

FTRBM001-W-R用 逆シフトチェンジレバー (正→逆)

RFTR164

KBA 90967

Con modelli moto **EURO 4**, le pedane acquistate per uso stradale devono essere tassativamente equipaggiate con poggiapiedi pieghevoli come previsto dall'ABE - With **EURO 4** motorcycle models, the rearsets purchased for street use must be strictly equipped with folding footpegs as required by the ABE - Con la moto **EURO4** la estribera para uso de calle debe llevar obligatoriamente el estribo abatible como previsto norma ABE - Für die Nutzung der Fussrastenanlage im öffentlichen Straßenverkehr ab Modelle mit **E4** sind klappbare Rasten erforderlich.

BMW

S1000R

Year: 14 - 16

TÜV homologated

S1000RR / HP4

Year: 09 - 14

TÜV homologated

Shifting: reverse

Poggiapiede fisso
Fixed footpeg
Cojinete y pedal fijo
Mit nicht klappbarer Rasten
固定式 ステップバー

FTRBM002

Poggiapiede snodato
Fold up footpeg
Cojinete y pedal abatible
Auf Kugellager mit klappbaren Rasten
可倒式 ステップバー

FTRBM002W

"R" version

FTRBM002R

Compatible with RFTR244

YES



KIT conversione cambio da rovesciato a standard per modello FTRBM002-W-R
Conversion kit reverse to standard shift for p/n FTRBM002-W-R
Kit de conversión cambio de invertido a standard para mod. FTRBM001-W-R
Kit Schaltbildänderung von umgedreht auf standard für Mod. FTRBM002-W-R
FTRBM002-W-R用 変換キット (逆⇒正)

RFTR207

KBA 90967

Con modelli moto **EURO 4**, le pedane acquistate per uso stradale devono essere tassativamente equipaggiate con poggiapiedi pieghevoli come previsto dall'ABE - With **EURO 4** motorcycle models, the rearsets purchased for street use must be strictly equipped with folding footpegs as required by the ABE - Con la moto **EURO4** la estribera para uso de calle debe llevar obligatoriamente el estribo abatible como previsto norma ABE - Für die Nutzung der Fussrastenanlage im öffentlichen Straßenverkehr ab Modelle mit **E4** sind klappbare Rasten erforderlich.

BMW

R NINE-T / SCRAMBLER PURE / URBAN / RACER

Year: 16 - 19

Not TÜV homologated

Shifting: standard

Poggiapiède snodato
Fold up footpeg
Cojinete y pedal abatible
Auf Kugellager mit klappbaren Rasten
可倒式 ステップバー

FTRBM005W

! END STOCK 廃盤



R1200 GS

Year: 13 - 18

Not TÜV homologated

Poggiapiède snodato
Fold up footpeg
Cojinete y pedal abatible
Auf Kugellager mit klappbaren Rasten
可倒式 ステップバー

FTRBM006NERW

! END STOCK 廃盤



Poggiapiède snodato
Fold up footpeg
Cojinete y pedal abatible
Auf Kugellager mit klappbaren Rasten
可倒式 ステップバー

FTRBM006COBW

! END STOCK 廃盤



Poggiapiède snodato
Fold up footpeg
Cojinete y pedal abatible
Auf Kugellager mit klappbaren Rasten
可倒式 ステップバー

FTRBM006ROSW

! END STOCK 廃盤



DUCATI

PANIGALE 899 / 1199 / 1299

Year: 12 - 17

TÜV homologated

PANIGALE 959

Year: 16 - 20

TÜV homologated

PANIGALE V2 955

Year: 20 - 24

TÜV homologated

Shifting: standard

Poggiapiede fisso

Fixed footpeg

Cojinete y pedal fijo

Mit nicht klappbarer Rasten

固定式ステップバー

FTRDU010

Poggiapiede snodato

Fold up footpeg

Cojinete y pedal abatible

Auf Kugellager mit klappbaren Rasten

可倒式ステップバー

FTRDU010W

"R" version

FTRDU010R



Shifting: reverse

Poggiapiede fisso

Fixed footpeg

Cojinete y pedal fijo

Mit nicht klappbarer Rasten

固定式ステップバー

FTRDU011

Poggiapiede snodato

Fold up footpeg

Cojinete y pedal abatible

Auf Kugellager mit klappbaren Rasten

可倒式ステップバー

FTRDU011W

"R" version

FTRDU011R



Compatible with RFTR244

NOT



KIT conversione cambio da standard a rovesciato per mod. FTRDU010-W-R / Conversion kit standard to reverse shift for p/n FTRDU010-W-R
 Kit de conversión estándar a invertido para mod. FTRDU010-W-R / Kit Schaltbildänderung von Standard in Reverse für Mod. FTRDU010-W-R
 FTRDU010-W-R用 逆シフトチェンジレバー (正→逆)

RFTR192



KIT conversione cambio da rovesciato a standard per mod. FTRDU011-W-R / Conversion kit reverse to standard shift for p/n FTRDU011-W-R /
 Kit de conversión de invertido a standard para mod. FTRDU011-W-R / Kit Schaltbildänderung von umgedreht auf standard für Mod. FTRDU011-
 W-R / FTRDU011-W-R用 変換キット (逆⇒正)

RFTR191

KBA 90967

Con modelli moto **EURO 4**, le pedane acquistate per uso stradale devono essere tassativamente equipaggiate con poggiapiedi pieghevoli come previsto dall'ABE - With **EURO 4** motorcycle models, the rearsets purchased for street use must be strictly equipped with folding footpegs as required by the ABE - Con la moto **EURO4** la estribera para uso de calle debe llevar obligatoriamente el estribo abatible como previsto norma ABE - Für die Nutzung der Fussrastenanlage im öffentlichen Straßenverkehr ab Modelle mit **E4** sind klappbare Rasten erforderlich.

PEDANE REGOLABILI

ADJUSTABLE REAR SETS - ESTRIBERAS REGULABLES - FUSSRASTENANLAGEN - アジャスタブル ステップ キット

DUCATI

PANIGALE 899 / 1199 / 1299 TRACK USE

Year: 12 - 17

PANIGALE V2 955 TRACK USE

Year: 20 - 24

Shifting: reverse

PoggiapiEDE fisso
Fixed footpeg
Cojinete y pedal fijo
Mit nicht klappbarer Rasten
固定式 ステップバー

FTRDU014

NEW
DESIGN

Renzi Corse
Simone Corsi

DUCATI

STREETFIGHTER V2

Year: 21 - 24

Shifting: standard

Poggiapiede fisso
Fixed footpeg
Cojinete y pedal fijo
Mit nicht klappbarer Rasten
固定式 ステップバー

FTRDU013

Poggiapiede snodato
Fold up footpeg
Cojinete y pedal abatible
Auf Kugellager mit klappbaren Rasten
可倒式 ステップバー

FTRDU013W

"R" version

FTRDU013R

**NEW
DESIGN**



PEDANE REGOLABILI

ADJUSTABLE REAR SETS - ESTRIBERAS REGULABLES - FUSSRASTENANLAGEN - アジャスタブルステップキット

DUCATI

PANIGALE V4 / V4 S / V4 R / SPECIALE

Year: 18 - 24

TÜV homologated

STREETFIGHTER V4 / V4 S

Year: 20 - 24

TÜV homologated

Shifting: standard - reverse

Poggiapiede fisso
Fixed footpeg
Cojinete y pedal fijo
Mit nicht klappbarer Rasten
固定式 ステップバー

FTRDU012

Poggiapiede snodato
Fold up footpeg
Cojinete y pedal abatible
Auf Kugellager mit klappbaren Rasten
可倒式 ステップバー

FTRDU012W

"R" version

FTRDU012R

Compatible with RFTR244

YES



KBA 90967

Con modelli moto **EURO 4**, le pedane acquistate per uso stradale devono essere tassativamente equipaggiate con poggiatepiù pieghevoli come previsto dall'ABE - With **EURO 4** motorcycle models, the rearsets purchased for street use must be strictly equipped with folding footpegs as required by the ABE - Con la moto **EURO4** la estribera para uso de calle debe llevar obligatoriamente el estribo abatible como previsto norma ABE - Für die Nutzung der Fussrastenanlage im öffentlichen Straßenverkehr ab Modelle mit **E4** sind klappbare Rasten erforderlich.

HONDA

CB 1000R

Year: 18 - 20

TÜV homologated

Shifting: standard - reverse

Poggiapiede fisso
Fixed footpeg
Cojinete y pedal fijo
Mit nicht klappbarer Rasten
固定式 ステップバー

FTRH0008

Poggiapiede snodato
Fold up footpeg
Cojinete y pedal abatible
Auf Kugellager mit klappbaren Rasten
可倒式 ステップバー

FTRH0008W

"R" version

FTRH0008R

Compatible with RFTR244

NOT



KBA 90967

Con modelli moto **EURO 4**, le pedane acquistate per uso stradale devono essere tassativamente equipaggiate con poggiapiedi pieghevoli come previsto dall'ABE - With **EURO 4** motorcycle models, the rearsets purchased for street use must be strictly equipped with folding footpegs as required by the ABE - Con la moto **EURO4** la estribera para uso de calle debe llevar obligatoriamente el estribo abatible como previsto norma ABE - Für die Nutzung der Fussrastenanlage im öffentlichen Straßenverkehr ab Modelle mit **E4** sind klappbare Rasten erforderlich.

PEDANE REGOLABILI

ADJUSTABLE REAR SETS - ESTRIBERAS REGULABLES - FUSSRASTENANLAGEN - アジャスタブル ステップ キット

HONDA

CBR 600 RR

Year: 07 - 16

TÜV homologated

Shifting: standard - reverse

Poggiapiede fisso
Fixed footpeg
Cojinete y pedal fijo
Mit nicht klappbarer Rasten
固定式 ステップバー

FTRH0005

Poggiapiede snodato
Fold up footpeg
Cojinete y pedal abatible
Auf Kugellager mit klappbaren Rasten
可倒式 ステップバー

FTRH0005W

"R" version

FTRH0005R

Compatible with RFTR244

NOT



KBA 90967

Con modelli moto **EURO 4**, le pedane acquistate per uso stradale devono essere tassativamente equipaggiate con poggiapiedi pieghevoli come previsto dall'ABE - With **EURO 4** motorcycle models, the rearsets purchased for street use must be strictly equipped with folding footpegs as required by the ABE - Con la moto **EURO4** la estribera para uso de calle debe llevar obligatoriamente el estribo abatible como previsto norma ABE - Für die Nutzung der Fussrastenanlage im öffentlichen Straßenverkehr ab Modelle mit **E4** sind klappbare Rasten erforderlich.

HONDA

**NEW
DESIGN**

CBR 1000 RR-R / SP

Year: 20 - 23

TÜV homologated

Shifting: standard - reverse

Poggiapiede fisso
Fixed footpeg
Cojinete y pedal fijo
Mit nicht klappbarer Rasten
固定式 ステップバー

FTRH0011

Poggiapiede snodato
Fold up footpeg
Cojinete y pedal abatible
Auf Kugellager mit klappbaren Rasten
可倒式 ステップバー

FTRH0011W

"R" version

FTRH0011R

Compatible with RFTR244

YES



Supporto leva cambio per uso racing (senza cavalletto laterale)
Gear lever support for race use (without side stand)
Soporte pedal de cambio uso racing (sin caballete lateral)
Halterung für Schaltstange - Racing (ohne Seitenständer)
レース用 ギアレバー サポート (サイドスタンド使用不可)

Year: 20 - 23

FTR883NER

KBA 90967

Con modelli moto **EURO 4**, le pedane acquistate per uso stradale devono essere tassativamente equipaggiate con poggiapiedi pieghevoli come previsto dall'ABE - With **EURO 4** motorcycle models, the rearsets purchased for street use must be strictly equipped with folding footpegs as required by the ABE - Con la moto **EURO4** la estribera para uso de calle debe llevar obligatoriamente el estribo abatible como previsto norma ABE - Für die Nutzung der Fussrastenanlage im öffentlichen Straßenverkehr ab Modelle mit **E4** sind klappbare Rasten erforderlich.

PEDANE REGOLABILI

ADJUSTABLE REAR SETS - ESTRIBERAS REGULABLES - FUSSRASTENANLAGEN - アジャスタブル ステップ キット

HONDA

CBR 1000 RR

Year: 08 - 19

TÜV homologated

Shifting: standard - reverse

Poggiapiede fisso
Fixed footpeg
Cojinete y pedal fijo
Mit nicht klappbarer Rasten
固定式 ステップバー

FTRH0006

Poggiapiede snodato
Fold up footpeg
Cojinete y pedal abatible
Auf Kugellager mit klappbaren Rasten
可倒式 ステップバー

FTRH0006W

"R" version

FTRH0006R

Compatible with RFTR244

NOT



KBA 90967

Con modelli moto **EURO 4**, le pedane acquistate per uso stradale devono essere tassativamente equipaggiate con poggiapiedi pieghevoli come previsto dall'ABE - With **EURO 4** motorcycle models, the rearsets purchased for street use must be strictly equipped with folding footpegs as required by the ABE - Con la moto **EURO4** la estribera para uso de calle debe llevar obligatoriamente el estribo abatible como previsto norma ABE - Für die Nutzung der Fussrastenanlage im öffentlichen Straßenverkehr ab Modelle mit **E4** sind klappbare Rasten erforderlich.

X-ADV

Year: 21 - 23

Not TÜV homologated

Poggiapiède snodato
Fold up footpeg
Cojinete y pedal abatible
Auf Kugellager mit klappbaren Rasten
可倒式ステップバー

FTRH0012NER

Poggiapiède snodato
Fold up footpeg
Cojinete y pedal abatible
Auf Kugellager mit klappbaren Rasten
可倒式ステップバー

FTRH0012COB

Poggiapiède snodato
Fold up footpeg
Cojinete y pedal abatible
Auf Kugellager mit klappbaren Rasten
可倒式ステップバー

FTRH0012ROS



X-ADV

Year: 17 - 20

Not TÜV homologated

Poggiapiède snodato
Fold up footpeg
Cojinete y pedal abatible
Auf Kugellager mit klappbaren Rasten
可倒式ステップバー

FTRH0009NER

Poggiapiède snodato
Fold up footpeg
Cojinete y pedal abatible
Auf Kugellager mit klappbaren Rasten
可倒式ステップバー

FTRH0009COB

Poggiapiède snodato
Fold up footpeg
Cojinete y pedal abatible
Auf Kugellager mit klappbaren Rasten
可倒式ステップバー

FTRH0009ROS



PEDANE REGOLABILI

ADJUSTABLE REAR SETS - ESTRIBERAS REGULABLES - FUSSRASTENANLAGEN - アジャスタブルステップキット

KAWASAKI

NINJA ZX-4RR TRACK USE

Year: 24 - 24

Shifting: standard - reverse

PoggiapiEDE fisso
 Fixed footpeg
 Cojinete y pedal fijo
 Mit nicht klappbarer Rasten
 固定式ステップバー

FTRKA014

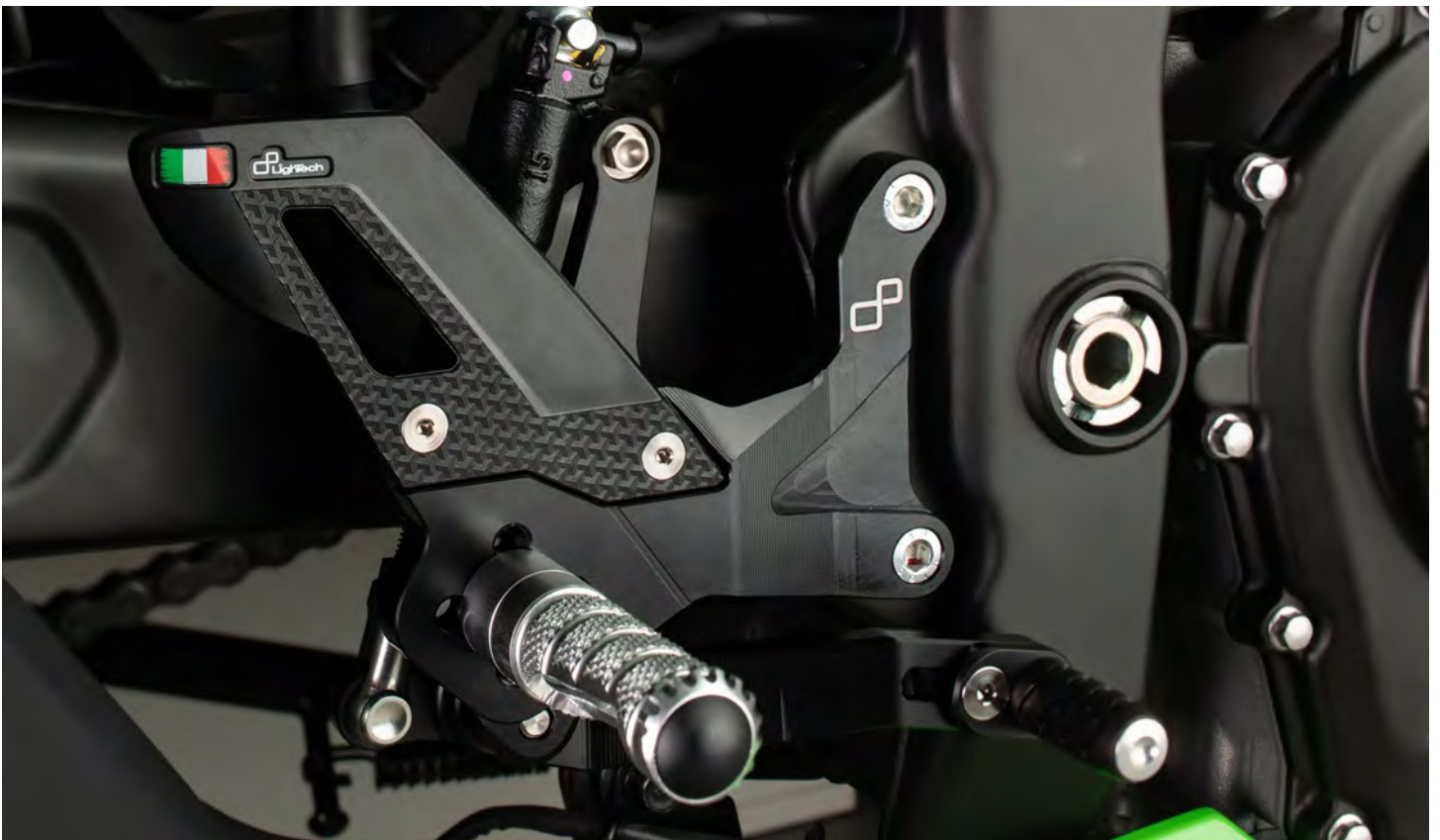

KAWASAKI

NINJA 400 **TRACK USE**

Year: 18 - 23

Shifting: standard - reverse

Poggiapiede fisso
Fixed footpeg
Cojinete y pedal fijo
Mit nicht klappbarer Rasten
固定式 ステップバー

FTRKA013



PEDANE REGOLABILI

ADJUSTABLE REAR SETS - ESTRIBERAS REGULABLES - FUSSRASTENANLAGEN - アジャスタブル ステップ キット

NINJA 400

Year: 18 - 23

TÜV homologated

Shifting: standard - reverse

Poggiapiede fisso
Fixed footpeg
Cojinete y pedal fijo
Mit nicht klappbarer Rasten
固定式 ステップバー

FTRKA007

! END STOCK 廃盤

Poggiapiede snodato
Fold up footpeg
Cojinete y pedal abatible
Auf Kugellager mit klappbaren Rasten
可倒式 ステップバー

FTRKA007W

! END STOCK 廃盤

"R" version

FTRKA007R

! END STOCK 廃盤

Compatible with RFTR244

NOT



KBA 90967

Con modelli moto **EURO 4**, le pedane acquistate per uso stradale devono essere tassativamente equipaggiate con poggiapiedi pieghevoli come previsto dall'ABE - With **EURO 4** motorcycle models, the rearsets purchased for street use must be strictly equipped with folding footpegs as required by the ABE - Con la moto **EURO4** la estribera para uso de calle debe llevar obligatoriamente el estribo abatible como previsto norma ABE - Für die Nutzung der Fussrastenanlage im öffentlichen Straßenverkehr ab Modelle mit **E4** sind klappbare Rasten erforderlich.

KAWASAKI

ZX6R - 636

Year: 05 - 21

TÜV homologated

Shifting: standard

Poggiapiede fisso
Fixed footpeg
Cojinete y pedal fijo
Mit nicht klappbarer Rasten
固定式 ステップバー

FTRKA008

Poggiapiede snodato
Fold up footpeg
Cojinete y pedal abatible
Auf Kugellager mit klappbaren Rasten
可倒式 ステップバー

FTRKA008W

"R" version

FTRKA008R



Shifting: reverse

Poggiapiede fisso
Fixed footpeg
Cojinete y pedal fijo
Mit nicht klappbarer Rasten
固定式 ステップバー

FTRKA009

Poggiapiede snodato
Fold up footpeg
Cojinete y pedal abatible
Auf Kugellager mit klappbaren Rasten
可倒式 ステップバー

FTRKA009W

"R" version

FTRKA009R



Compatible with RFTR244

YES

KBA 90967

Con modelli moto **EURO 4**, le pedane acquistate per uso stradale devono essere tassativamente equipaggiate con poggiapiedi pieghevoli come previsto dall'ABE - With **EURO 4** motorcycle models, the rearsets purchased for street use must be strictly equipped with folding footpegs as required by the ABE - Con la moto **EURO4** la estribera para uso de calle debe llevar obligatoriamente el estribo abatible como previsto norma ABE - Für die Nutzung der Fussrastenanlage im öffentlichen Straßenverkehr ab Modelle mit **E4** sind klappbare Rasten erforderlich.

PEDANE REGOLABILI

ADJUSTABLE REAR SETS - ESTRIBERAS REGULABLES - FUSSRASTENANLAGEN - アジャスタブルステップキット

ZX10R

Year: 21 - 23

TÜV homologated

Shifting: standard

PoggiapiEDE fisso
Fixed footpeg
Cojinete y pedal fijo
Mit nicht klappbarer Rasten
固定式ステップバー

FTRKA011

PoggiapiEDE snodato
Fold up footpeg
Cojinete y pedal abatible
Auf Kugellager mit klappbaren Rasten
可倒式ステップバー

FTRKA011W

"R" version

FTRKA011R

Shifting: reverse

PoggiapiEDE fisso
Fixed footpeg
Cojinete y pedal fijo
Mit nicht klappbarer Rasten
固定式ステップバー

FTRKA012

PoggiapiEDE snodato
Fold up footpeg
Cojinete y pedal abatible
Auf Kugellager mit klappbaren Rasten
可倒式ステップバー

FTRKA012W

"R" version

FTRKA012R

Compatible with RFTR244

YES



KBA 90967

Con modelli moto **EURO 4**, le pedane acquistate per uso stradale devono essere tassativamente equipaggiate con poggia piedi pieghevoli come previsto dall'ABE - With **EURO 4** motorcycle models, the rearsets purchased for street use must be strictly equipped with folding footpegs as required by the ABE - Con la moto **EURO4** la estribera para uso de calle debe llevar obligatoriamente el estribo abatible como previsto norma ABE - Für die Nutzung der Fussrastenanlage im öffentlichen Straßenverkehr ab Modelle mit **E4** sind klappbare Rasten erforderlich.

KAWASAKI

ZX10R

Year: 16 - 20

TÜV homologated

Shifting: standard

Poggiapiede fisso
Fixed footpeg
Cojinete y pedal fijo
Mit nicht klappbarer Rasten
固定式 ステップバー

FTRKA006

Poggiapiede snodato
Fold up footpeg
Cojinete y pedal abatible
Auf Kugellager mit klappbaren Rasten
可倒式 ステップバー

FTRKA006W

"R" version

FTRKA006R

Compatible with RFTR244

NOT



KIT conversione cambio da standard a rovesciato per modello FTRKA006-W-R
Conversion kit standard to reverse shift for p/n FTRKA006-W-R
Kit de conversión cambio estándar a invertido para mod. FTRKA006-W-R
Kit Schaltbildänderung von Standard in Reverse für Mod. FTRKA006-W-R
FTRKA006-W-R用 逆シフトチェンジレバー (正→逆)

Year: 16 - 20

RFTR232

KBA 90967

Con modelli moto **EURO 4**, le pedane acquistate per uso stradale devono essere tassativamente equipaggiate con poggiapiedi pieghevoli come previsto dall'ABE - With **EURO 4** motorcycle models, the rearsets purchased for street use must be strictly equipped with folding footpegs as required by the ABE - Con la moto **EURO4** la estribera para uso de calle debe llevar obligatoriamente el estribo abatible como previsto norma ABE - Für die Nutzung der Fussrastenanlage im öffentlichen Straßenverkehr ab Modelle mit **E4** sind klappbare Rasten erforderlich.

PEDANE REGOLABILI

ADJUSTABLE REAR SETS - ESTRIBERAS REGULABLES - FUSSRASTENANLAGEN - アジャスタブル ステップ キット

ZX 10R

Year: 11 - 15

TÜV homologated

Shifting: standard - reverse

Poggiapiede fisso
Fixed footpeg
Cojinete y pedal fijo
Mit nicht klappbarer Rasten
固定式 ステップバー

FTRKA003

Poggiapiede snodato
Fold up footpeg
Cojinete y pedal abatible
Auf Kugellager mit klappbaren Rasten
可倒式 ステップバー

FTRKA003W

"R" version

FTRKA003R

Compatible with RFTR244

NOT



KBA 90967

Con modelli moto **EURO 4**, le pedane acquistate per uso stradale devono essere tassativamente equipaggiate con poggiapiedi pieghevoli come previsto dall'ABE - With **EURO 4** motorcycle models, the rearsets purchased for street use must be strictly equipped with folding footpegs as required by the ABE - Con la moto **EURO4** la estribera para uso de calle debe llevar obligatoriamente el estribo abatible como previsto norma ABE - Für die Nutzung der Fussrastenanlage im öffentlichen Straßenverkehr ab Modelle mit **E4** sind klappbare Rasten erforderlich.

KAWASAKI

Z 900

Year: 17 - 23

TÜV homologated

Shifting: standard - reverse

Poggiapiede fisso
Fixed footpeg
Cojinete y pedal fijo
Mit nicht klappbarer Rasten
固定式 ステップバー

FTRKA010

Poggiapiede snodato
Fold up footpeg
Cojinete y pedal abatible
Auf Kugellager mit klappbaren Rasten
可倒式 ステップバー

FTRKA010W

"R" version

FTRKA010R

Compatible with RFTR244

YES



KBA 90967

Con modelli moto **EURO 4**, le pedane acquistate per uso stradale devono essere tassativamente equipaggiate con poggiapiedi pieghevoli come previsto dall'ABE - With **EURO 4** motorcycle models, the rearsets purchased for street use must be strictly equipped with folding footpegs as required by the ABE - Con la moto **EURO4** la estribera para uso de calle debe llevar obligatoriamente el estribo abatible como previsto norma ABE - Für die Nutzung der Fussrastenanlage im öffentlichen Straßenverkehr ab Modelle mit **E4** sind klappbare Rasten erforderlich.

PEDANE REGOLABILI

ADJUSTABLE REAR SETS - ESTRIBERAS REGULABLES - FUSSRASTENANLAGEN - アジャスタブルステップキット

KTM

SUPER DUKE 1290 R

Year: 20 - 23

SUPER DUKE 1390 R **NEW**

Year: 24 - 24

Shifting: standard - reverse

Poggiapiede fisso
Fixed footpeg
Cojinete y pedal fijo
Mit nicht klappbarer Rasten
固定式 ステップバー

FTRKT004

Poggiapiede snodato
Fold up footpeg
Cojinete y pedal abatible
Auf Kugellager mit klappbaren Rasten
可倒式 ステップバー

FTRKT004W

"R" version

FTRKT004R

Compatible with RFTR244

YES

**NEW
DESIGN**

KTMM

**NEW
DESIGN**

DUKE 790

Year: 18 - 23

TÜV homologated

DUKE 890 R

Year: 20 - 23

TÜV homologated

Shifting: standard - reverse

Poggiapiede fisso
Fixed footpeg
Cojinete y pedal fijo
Mit nicht klappbarer Rasten
固定式 ステップバー

FTRKT002

Poggiapiede snodato
Fold up footpeg
Cojinete y pedal abatible
Auf Kugellager mit klappbaren Rasten
可倒式 ステップバー

FTRKT002W

"R" version

FTRKT002R

Compatible with RFTR244

YES



KBA 90967

Con modelli moto **EURO 4**, le pedane acquistate per uso stradale devono essere tassativamente equipaggiate con poggiapiedi pieghevoli come previsto dall'ABE - With **EURO 4** motorcycle models, the rearsets purchased for street use must be strictly equipped with folding footpegs as required by the ABE - Con la moto **EURO4** la estribera para uso de calle debe llevar obligatoriamente el estribo abatible como previsto norma ABE - Für die Nutzung der Fussrastenanlage im öffentlichen Straßenverkehr ab Modelle mit **E4** sind klappbare Rasten erforderlich.

PEDANE REGOLABILI

ADJUSTABLE REAR SETS - ESTRIBERAS REGULABLES - FUSSRASTENANLAGEN - アジャスタブルステップキット

KTM

RC 125 / 200 / 390

Year: 17 - 20

FOR RACING USE ONLY

Not TÜV homologated

Shifting: standard - reverse

Poggiapiede fisso
 Fixed footpeg
 Cojinete y pedal fijo
 Mit nicht klappbarer Rasten
 固定式 ステップバー

FTRKT001

! END STOCK 廃盤

Poggiapiede snodato
 Fold up footpeg
 Cojinete y pedal abatible
 Auf Kugellager mit klappbaren Rasten
 可倒式 ステップバー

FTRKT001W

! END STOCK 廃盤



SUZUKI

GSX-R 600 / 750

Year: 11 - 17

TÜV homologated

Shifting: standard - reverse

Poggiapiede fisso
Fixed footpeg
Cojinete y pedal fijo
Mit nicht klappbarer Rasten
固定式 ステップバー

FTRSU002

Poggiapiede snodato
Fold up footpeg
Cojinete y pedal abatible
Auf Kugellager mit klappbaren Rasten
可倒式 ステップバー

FTRSU002W

"R" version

FTRSU002R

Compatible with RFTR244

NOT



KBA 90967

Con modelli moto **EURO 4**, le pedane acquistate per uso stradale devono essere tassativamente equipaggiate con poggiapiedi pieghevoli come previsto dall'ABE - With **EURO 4** motorcycle models, the rearsets purchased for street use must be strictly equipped with folding footpegs as required by the ABE - Con la moto **EURO4** la estribera para uso de calle debe llevar obligatoriamente el estribo abatible como previsto norma ABE - Für die Nutzung der Fussrastenanlage im öffentlichen Straßenverkehr ab Modelle mit **E4** sind klappbare Rasten erforderlich.

PEDANE REGOLABILI

ADJUSTABLE REAR SETS - ESTRIBERAS REGULABLES - FUSSRASTENANLAGEN - アジャスタブル ステップ キット

SUZUKI

GSX-R 1000 / R

Year: 17 - 23

TÜV homologated

Shifting: standard - reverse

Poggiapiede fisso
Fixed footpeg
Cojinete y pedal fijo
Mit nicht klappbarer Rasten
固定式 ステップバー

FTRSU004

Poggiapiede snodato
Fold up footpeg
Cojinete y pedal abatible
Auf Kugellager mit klappbaren Rasten
可倒式 ステップバー

FTRSU004W

"R" version

FTRSU004R

Compatible with RFTR244

NOT



KBA 90967

Con modelli moto **EURO 4**, le pedane acquistate per uso stradale devono essere tassativamente equipaggiate con poggiapiedi pieghevoli come previsto dall'ABE - With **EURO 4** motorcycle models, the rearsets purchased for street use must be strictly equipped with folding footpegs as required by the ABE - Con la moto **EURO4** la estribera para uso de calle debe llevar obligatoriamente el estribo abatible como previsto norma ABE - Für die Nutzung der Fussrastenanlage im öffentlichen Straßenverkehr ab Modelle mit **E4** sind klappbare Rasten erforderlich.

SUZUKI

GSX-S 1000 / GT

Year: 15 - 23

TÜV homologated

Shifting: standard - reverse

Poggiapiede fisso
Fixed footpeg
Cojinete y pedal fijo
Mit nicht klappbarer Rasten
固定式 ステップバー

FTRSU003

Poggiapiede snodato
Fold up footpeg
Cojinete y pedal abatible
Auf Kugellager mit klappbaren Rasten
可倒式 ステップバー

FTRSU003W

"R" version

FTRSU003R

Compatible with RFTR244

NOT



KBA 90967

Con modelli moto **EURO 4**, le pedane acquistate per uso stradale devono essere tassativamente equipaggiate con poggiapiedi pieghevoli come previsto dall'ABE - With **EURO 4** motorcycle models, the rearsets purchased for street use must be strictly equipped with folding footpegs as required by the ABE - Con la moto **EURO4** la estribera para uso de calle debe llevar obligatoriamente el estribo abatible como previsto norma ABE - Für die Nutzung der Fussrastenanlage im öffentlichen Straßenverkehr ab Modelle mit **E4** sind klappbare Rasten erforderlich.

PEDANE REGOLABILI

ADJUSTABLE REAR SETS - ESTRIBERAS REGULABLES - FUSSRASTENANLAGEN - アジャスタブル ステップ キット

TRIUMPH

DAYTONA 675 / 765 (all versions)

Year: 13 - 21

TÜV homologated

STREET TRIPLE 765 (all versions)

Year: 17 - 24

TÜV homologated

Shifting: standard - reverse

PoggiapiEDE fisso
Fixed footpeg
Cojinete y pedal fijo
Mit nicht klappbarer Rasten
固定式 ステップバー

FTRTR005

PoggiapiEDE snodato
Fold up footpeg
Cojinete y pedal abatible
Auf Kugellager mit klappbaren Rasten
可倒式 ステップバー

FTRTR005W

"R" version

FTRTR005R

Compatible with RFTR244

YES



KBA 90967

Con modelli moto **EURO 4**, le pedane acquistate per uso stradale devono essere tassativamente equipaggiate con poggiatepiE pieghevoli come previsto dall'ABE - With **EURO 4** motorcycle models, the rearsets purchased for street use must be strictly equipped with folding footpegs as required by the ABE - Con la moto **EURO4** la estribera para uso de calle debe llevar obligatoriamente el estribo abatible como previsto norma ABE - Für die Nutzung der Fussrastenanlage im öffentlichen Straßenverkehr ab Modelle mit **E4** sind klappbare Rasten erforderlich.

TRIUMPH

SPEED TRIPLE RS 1200 / RR 1200

Year: 21 - 24

TÜV homologated

Shifting: standard - reverse

Poggiapiede fisso
Fixed footpeg
Cojinete y pedal fijo
Mit nicht klappbarer Rasten
固定式 ステップバー

FTRTR006

Poggiapiede snodato
Fold up footpeg
Cojinete y pedal abatible
Auf Kugellager mit klappbaren Rasten
可倒式 ステップバー

FTRTR006W

"R" version

FTRTR006R

Compatible with RFTR244

YES



KBA 90967

Con modelli moto **EURO 4**, le pedane acquistate per uso stradale devono essere tassativamente equipaggiate con poggiapiedi pieghevoli come previsto dall'ABE - With **EURO 4** motorcycle models, the rearsets purchased for street use must be strictly equipped with folding footpegs as required by the ABE - Con la moto **EURO4** la estribera para uso de calle debe llevar obligatoriamente el estribo abatible como previsto norma ABE - Für die Nutzung der Fussrastenanlage im öffentlichen Straßenverkehr ab Modelle mit **E4** sind klappbare Rasten erforderlich.

PEDANE REGOLABILI

ADJUSTABLE REAR SETS - ESTRIBERAS REGULABLES - FUSSRASTENANLAGEN - アジャスタブルステップキット

YAMAHA

MT-07 / MT-07 TRACER

Year: 14 - 24

TÜV homologated

TRACER 7 / TRACER 7 GT

Year: 20 - 24

TÜV homologated

Shifting: standard

Poggiapiede fisso
Fixed footpeg
Cojinete y pedal fijo
Mit nicht klappbarer Rasten
固定式 ステップバー

FTRYA008

Poggiapiede snodato
Fold up footpeg
Cojinete y pedal abatible
Auf Kugellager mit klappbaren Rasten
可倒式 ステップバー

FTRYA008W

"R" version

FTRYA008R

Compatible with RFTR244

NOT



KBA 90967

Con modelli moto **EURO 4**, le pedane acquistate per uso stradale devono essere tassativamente equipaggiate con poggiatepiù pieghevoli come previsto dall'ABE - With **EURO 4** motorcycle models, the rearsets purchased for street use must be strictly equipped with folding footpegs as required by the ABE - Con la moto **EURO4** la estribera para uso de calle debe llevar obligatoriamente el estribo abatible como previsto norma ABE - Für die Nutzung der Fussrastenanlage im öffentlichen Straßenverkehr ab Modelle mit **E4** sind klappbare Rasten erforderlich.

YAMAHA

MT-09 / MT-09 TRACER XSR900

Year: 13 - 20

TÜV homologated

Shifting: standard

Poggiapiede fisso
Fixed footpeg
Cojinete y pedal fijo
Mit nicht klappbarer Rasten
固定式 ステップバー

FTRYA007

! END STOCK 廃盤

Poggiapiede snodato
Fold up footpeg
Cojinete y pedal abatible
Auf Kugellager mit klappbaren Rasten
可倒式 ステップバー

FTRYA007W

! END STOCK 廃盤

"R" version

FTRYA007R

! END STOCK 廃盤

Compatible with RFTR244

NOT



KBA 90967

Con modelli moto **EURO 4**, le pedane acquistate per uso stradale devono essere tassativamente equipaggiate con poggiapiedi pieghevoli come previsto dall'ABE - With **EURO 4** motorcycle models, the rearsets purchased for street use must be strictly equipped with folding footpegs as required by the ABE - Con la moto **EURO4** la estribera para uso de calle debe llevar obligatoriamente el estribo abatible como previsto norma ABE - Für die Nutzung der Fussrastenanlage im öffentlichen Straßenverkehr ab Modelle mit **E4** sind klappbare Rasten erforderlich.

PEDANE REGOLABILI

ADJUSTABLE REAR SETS - ESTRIBERAS REGULABLES - FUSSRASTENANLAGEN - アジャスタブル ステップ キット

YAMAHA

MT-09 / SP / TRACER 9 TRACER 9 GT

Year: 21 - 24

TÜV homologated

Shifting: standard - reverse

Poggiapiede fisso
Fixed footpeg
Cojinete y pedal fijo
Mit nicht klappbarer Rasten
固定式 ステップバー

FTRYA017

Poggiapiede snodato
Fold up footpeg
Cojinete y pedal abatible
Auf Kugellager mit klappbaren Rasten
可倒式 ステップバー

FTRYA017W

"R" version

FTRYA017R

Compatible with RFTR244

YES



KBA 90967

Con modelli moto **EURO 4**, le pedane acquistate per uso stradale devono essere tassativamente equipaggiate con poggiapiedi pieghevoli come previsto dall'ABE - With **EURO 4** motorcycle models, the rearsets purchased for street use must be strictly equipped with folding footpegs as required by the ABE - Con la moto **EURO4** la estribera para uso de calle debe llevar obligatoriamente el estribo abatible como previsto norma ABE - Für die Nutzung der Fussrastenanlage im öffentlichen Straßenverkehr ab Modelle mit **E4** sind klappbare Rasten erforderlich.

YAMAHA

MT-10 / MT-10 SP

Year: 16 - 23

TÜV homologated

Shifting: standard - reverse

Poggiapiède fisso
Fixed footpeg
Cojinete y pedal fijo
Mit nicht klappbarer Rasten
固定式 ステップバー

FTRYA011

Poggiapiède snodato
Fold up footpeg
Cojinete y pedal abatible
Auf Kugellager mit klappbaren Rasten
可倒式 ステップバー

FTRYA011W

"R" version

FTRYA011R

Compatible with RFTR244

YES



KBA 90967

Con modelli moto **EURO 4**, le pedane acquistate per uso stradale devono essere tassativamente equipaggiate con poggiapièdi pieghevoli come previsto dall'ABE - With **EURO 4** motorcycle models, the rearsets purchased for street use must be strictly equipped with folding footpegs as required by the ABE - Con la moto **EURO4** la estribera para uso de calle debe llevar obligatoriamente el estribo abatible como previsto norma ABE - Für die Nutzung der Fussrastenanlage im öffentlichen Straßenverkehr ab Modelle mit **E4** sind klappbare Rasten erforderlich.

PEDANE REGOLABILI

ADJUSTABLE REAR SETS - ESTRIBERAS REGULABLES - FUSSRASTENANLAGEN - アジャスタブルステップキット

YAMAHA

**NEW
DESIGN**

R1 / R1M

Year: 15 - 24

TÜV homologated

Shifting: standard - reverse

Poggiapiede fisso
Fixed footpeg
Cojinete y pedal fijo
Mit nicht klappbarer Rasten
固定式 ステップバー

FTRYA016

Poggiapiede snodato
Fold up footpeg
Cojinete y pedal abatible
Auf Kugellager mit klappbaren Rasten
可倒式 ステップバー

FTRYA016W

"R" version

FTRYA016R

Compatible with RFTR244

YES



Staffa di supporto per leva cambio e catalizzatore per R1 dal 2020. Permette rimozione cavalletto laterale.
Support bracket for gear lever and catalyzer for R1 from 2020. It allows the removal of side stand.
Pieza soporte para palanca de cambio y catalizador R1 2020 que permite quitar el caballete lateral.
Halterung für Schaltstange und Katalysator für R1 BJ ab 2020: das ermöglicht die Entfernung des seitlichen Ständer
YZF-R1 2020年式用のギアレバーとキャタライザー固定用サポートブラケット。サイドスタンドを取り除くことができます。

Year: 20 - 24

FTR862NER



Staffa di supporto per leva cambio per R1 dal 2015-2019. Permette rimozione cavalletto laterale.
Support bracket for gear lever for R1 from 2015 to 2019. It allows the removal of side stand.
Pieza soporte para palanca de cambio R1 2015-2020 que permite quitar el caballete lateral.
Halterung für Schaltstange für R1 BJ 2015-2019: das ermöglicht die Entfernung des seitlichen Ständer.
YZF-R1 2015-2019年式用のギアレバー固定用サポートブラケット。サイドスタンドを取り除くことができます。

Year: 15 - 19

FTR632NER

KBA 90967

Con modelli moto **EURO 4**, le pedane acquistate per uso stradale devono essere tassativamente equipaggiate con poggiapiedi pieghevoli come previsto dall'ABE - With **EURO 4** motorcycle models, the rearsets purchased for street use must be strictly equipped with folding footpegs as required by the ABE - Con la moto **EURO4** la estribera para uso de calle debe llevar obligatoriamente el estribo abatible como previsto norma ABE - Für die Nutzung der Fussrastenanlage im öffentlichen Straßenverkehr ab Modelle mit **E4** sind klappbare Rasten erforderlich.

YAMAHA

NEW
DESIGN

R1 TRACK USE

Year: 15 - 24

Shifting: standard - reverse

Poggiapiede fisso
Fixed footpeg
Cojinete y pedal fijo
Mit nicht klappbarer Rasten
固定式 ステップバー

FTRYA020



Staffa di supporto per leva cambio e catalizzatore per R1 dal 2020. Permette rimozione cavalletto laterale.
Support bracket for gear lever and catalyst for R1 from 2020. It allows the removal of side stand.
Pieza soporte para palanca de cambio y catalizador R1 2020 que permite quitar el caballete lateral.
Halterung für Schaltstange und Katalysator für R1 BJ ab 2020: das ermöglicht die Entfernung des seitlichen Ständer
YZF-R1 2020年式用のギアレバーとキャタライザー固定用サポートブラケット。サイドスタンドを取り除くことができます。

Year: 20 - 24

FTR862NER



Staffa di supporto per leva cambio per R1 dal 2015-2019. Permette rimozione cavalletto laterale.
Support bracket for gear lever for R1 from 2015 to 2019. It allows the removal of side stand.
Pieza soporte para palanca de cambio R1 2015-2020 que permite quitar el caballete lateral.
Halterung für Schaltstange für R1 BJ 2015-2019: das ermöglicht die Entfernung des seitlichen Ständer.
YZF-R1 2015-2019年式用のギアレバー固定用サポートブラケット。サイドスタンドを取り除くことができます。

Year: 15 - 19

FTR632NER

PEDANE REGOLABILI

ADJUSTABLE REAR SETS - ESTRIBERAS REGULABLES - FUSSRASTENANLAGEN - アジャスタブル ステップ キット

YAMAHA

R1

Year: 09 - 14

TÜV homologated

Shifting: standard - reverse

Poggiapiede fisso
Fixed footpeg
Cojinete y pedal fijo
Mit nicht klappbarer Rasten
固定式 ステップバー

FTRYA001

Poggiapiede snodato
Fold up footpeg
Cojinete y pedal abatible
Auf Kugellager mit klappbaren Rasten
可倒式 ステップバー

FTRYA001W

"R" version

FTRYA001R

Compatible with RFTR244

NOT



KBA 90967

Con modelli moto **EURO 4**, le pedane acquistate per uso stradale devono essere tassativamente equipaggiate con poggiapiedi pieghevoli come previsto dall'ABE - With **EURO 4** motorcycle models, the rearsets purchased for street use must be strictly equipped with folding footpegs as required by the ABE - Con la moto **EURO4** la estribera para uso de calle debe llevar obligatoriamente el estribo abatible como previsto norma ABE - Für die Nutzung der Fussrastenanlage im öffentlichen Straßenverkehr ab Modelle mit **E4** sind klappbare Rasten erforderlich.

YAMAHA

R3

Year: 15 - 24

TÜV homologated

Shifting: standard

Poggiapiede fisso
Fixed footpeg
Cojinete y pedal fijo
Mit nicht klappbarer Rasten
固定式 ステップバー

FTRYA013

! END STOCK 廃盤

Poggiapiede snodato
Fold up footpeg
Cojinete y pedal abatible
Auf Kugellager mit klappbaren Rasten
可倒式 ステップバー

FTRYA013W

! END STOCK 廃盤

"R" version

FTRYA013R

! END STOCK 廃盤

Shifting: reverse

Poggiapiede fisso
Fixed footpeg
Cojinete y pedal fijo
Mit nicht klappbarer Rasten
固定式 ステップバー

FTRYA014

! END STOCK 廃盤

Poggiapiede snodato
Fold up footpeg
Cojinete y pedal abatible
Auf Kugellager mit klappbaren Rasten
可倒式 ステップバー

FTRYA014W

! END STOCK 廃盤

"R" version

FTRYA014R

! END STOCK 廃盤



Compatible with RFTR244

NOT

KBA 90967

Con modelli moto **EURO 4**, le pedane acquistate per uso stradale devono essere tassativamente equipaggiate con poggiapiedi pieghevoli come previsto dall'ABE - With **EURO 4** motorcycle models, the rearsets purchased for street use must be strictly equipped with folding footpegs as required by the ABE - Con la moto **EURO4** la estribera para uso de calle debe llevar obligatoriamente el estribero abatible como previsto norma ABE - Für die Nutzung der Fussrastenanlage im öffentlichen Straßenverkehr ab Modelle mit **E4** sind klappbare Rasten erforderlich.

PEDANE REGOLABILI

ADJUSTABLE REAR SETS - ESTRIBERAS REGULABLES - FUSSRASTENANLAGEN - アジャスタブルステップキット

YAMAHA

R3 TRACK USE

Year: 15 - 24

Shifting: standard - reverse

Poggiapiede fisso
Fixed footpeg
Cojinete y pedal fijo
Mit nicht klappbarer Rasten
固定式ステップバー

FTRYA019



YAMAHA

**NEW
DESIGN**

R6

Year: 17 - 24

TÜV homologated

Shifting: standard - reverse

Poggiapiede fisso
Fixed footpeg
Cojinete y pedal fijo
Mit nicht klappbarer Rasten
固定式 ステップバー

FTRYA012

Poggiapiede snodato
Fold up footpeg
Cojinete y pedal abatible
Auf Kugellager mit klappbaren Rasten
可倒式 ステップバー

FTRYA012W

"R" version

FTRYA012R

Compatible with RFTR244

YES



KBA 90967

Con modelli moto **EURO 4**, le pedane acquistate per uso stradale devono essere tassativamente equipaggiate con poggiapiedi pieghevoli come previsto dall'ABE - With **EURO 4** motorcycle models, the rearsets purchased for street use must be strictly equipped with folding footpegs as required by the ABE - Con la moto **EURO4** la estribera para uso de calle debe llevar obligatoriamente el estribo abatible como previsto norma ABE - Für die Nutzung der Fussrastenanlage im öffentlichen Straßenverkehr ab Modelle mit **E4** sind klappbare Rasten erforderlich.

PEDANE REGOLABILI

ADJUSTABLE REAR SETS - ESTRIBERAS REGULABLES - FUSSRASTENANLAGEN - アジャスタブル ステップ キット

YAMAHA

R6

Year: 08 - 16

TÜV homologated

Shifting: standard - reverse

Poggiapiede fisso
Fixed footpeg
Cojinete y pedal fijo
Mit nicht klappbarer Rasten
固定式 ステップバー

FTRYA002

Poggiapiede snodato
Fold up footpeg
Cojinete y pedal abatible
Auf Kugellager mit klappbaren Rasten
可倒式 ステップバー

FTRYA002W

"R" version

FTRYA002R

Compatible with RFTR244

YES



KBA 90967

Con modelli moto **EURO 4**, le pedane acquistate per uso stradale devono essere tassativamente equipaggiate con poggiapiedi pieghevoli come previsto dall'ABE - With **EURO 4** motorcycle models, the rearsets purchased for street use must be strictly equipped with folding footpegs as required by the ABE - Con la moto **EURO4** la estribera para uso de calle debe llevar obligatoriamente el estribo abatible como previsto norma ABE - Für die Nutzung der Fussrastenanlage im öffentlichen Straßenverkehr ab Modelle mit **E4** sind klappbare Rasten erforderlich.

YAMAHA

R7

Year: 22 - 24

TÜV homologated

Shifting: standard - reverse

Poggiapiede fisso
Fixed footpeg
Cojinete y pedal fijo
Mit nicht klappbarer Rasten
固定式 ステップバー

FTRYA018

Poggiapiede snodato
Fold up footpeg
Cojinete y pedal abatible
Auf Kugellager mit klappbaren Rasten
可倒式 ステップバー

FTRYA018W

"R" version

FTRYA018R

Compatible with RFTR244

YES



KBA 90967

Con modelli moto **EURO 4**, le pedane acquistate per uso stradale devono essere tassativamente equipaggiate con poggiapiedi pieghevoli come previsto dall'ABE - With **EURO 4** motorcycle models, the rearsets purchased for street use must be strictly equipped with folding footpegs as required by the ABE - Con la moto **EURO4** la estribera para uso de calle debe llevar obligatoriamente el estribo abatible como previsto norma ABE - Für die Nutzung der Fussrastenanlage im öffentlichen Straßenverkehr ab Modelle mit **E4** sind klappbare Rasten erforderlich.

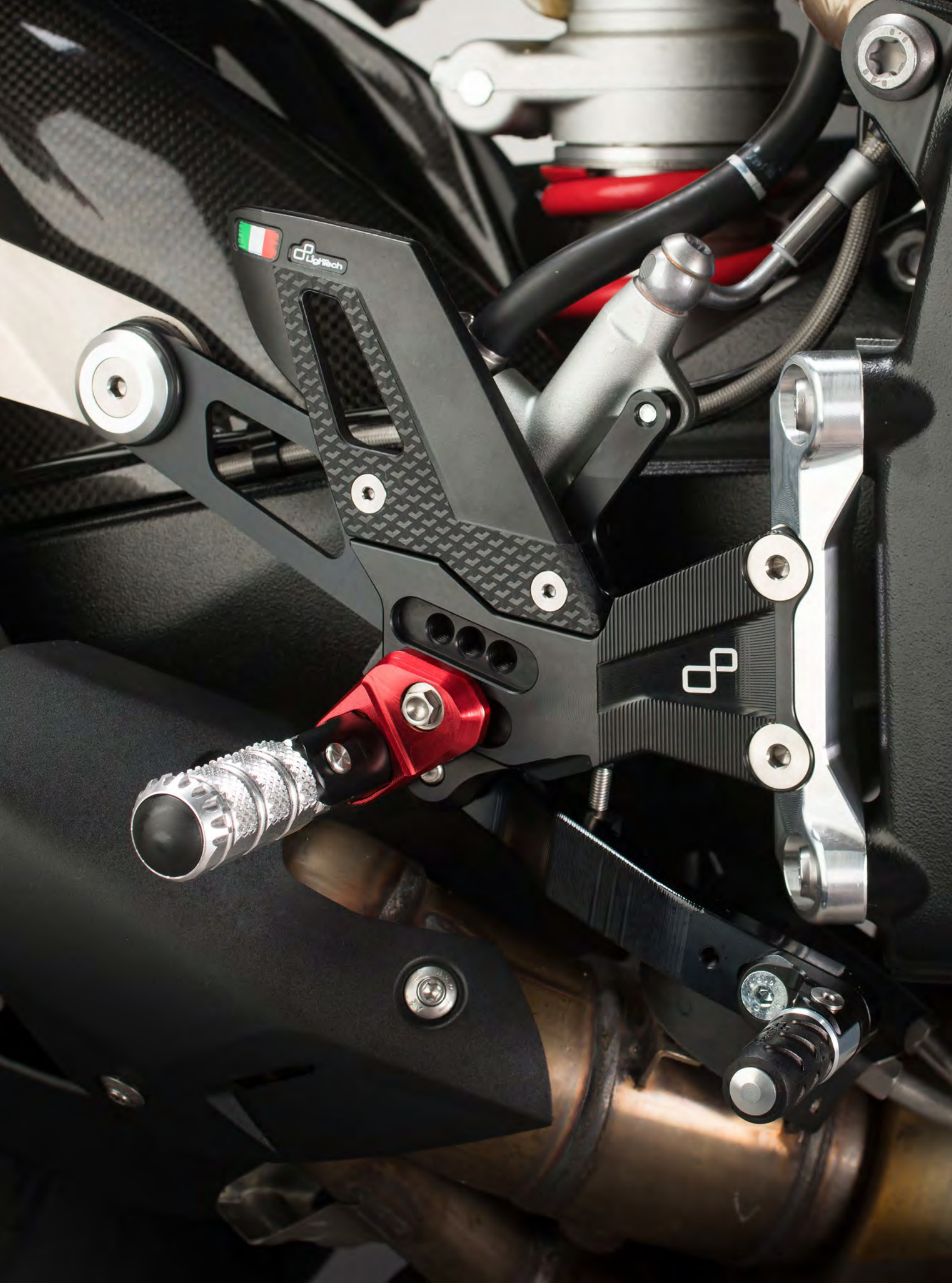

COMPONENTI RICAMBIO PER PEDANE

REAR SET SPARE PARTS - COMPONENTES DE RECAMBIO ESTRIBERAS - ERSATZTEILE FÜR FUSSRASTENANLAGEN - ステップ キット スペアパーツ



Available colours

silver

black



Poggiapiede fisso

Fixed footpeg - Estribera de apoyo fijo - Feste Raste - 固定式 ステップバー

				Code	for piece
Poggiapiede fisso Fixed footpeg Estribera de apoyo fijo Feste Raste 固定式 ステップバー	+	vite M8x20 bolt M8x20 tornillo M8x20 Schrauben M8x20 皿ボルト M8x20	=	RFTR245	
Poggiapiede fisso Fixed footpeg Estribera de apoyo fijo Feste Raste 固定式 ステップバー	+	vite M8x25 bolt M8x25 tornillo M8x25 Schrauben M8x25 皿ボルト M8x25	=	RFTR246	
Poggiapiede fisso Fixed footpeg Estribera de apoyo fijo Feste Raste 固定式 ステップバー	+	vite M8x45 bolt M8x45 tornillo M8x45 Schrauben M8x45 皿ボルト M8x45	=	RFTR247	
Poggiapiede fisso Fixed footpeg Estribera de apoyo fijo Feste Raste 固定式 ステップバー	+	vite testa cilindrica M8x20 cylindrical head bolt M8x20 tornillo cabeza cilindrica M8x20 Schrauben mit Zylinderkopt M8x20 キャップボルト M8x20	=	RFTR248	



Available colours

silver



Poggiapiede fisso

Fixed footpeg - Estribera de apoyo fijo - Feste Raste - 固定式 ステップバー

				Code	for piece
Poggiapiede fisso Fixed footpeg Estribera de apoyo fijo Feste Raste 固定式 ステップバー	+	vite M8x20 bolt M8x20 tornillo M8x20 Schrauben M8x20 皿ボルト M8x20	=	RFTR330	



Available colours



Poggiapiede snodato

Folding footpeg - Estribera de apoyo abatible basculante Klappbare Fussraste - 可倒式 ステップバー

					Code	for piece
Poggiapiede snodato Folding footpeg Estribera de apoyo abatible basculante Klappbare Raste 可倒式 ステップバー	+	vite M8x20 bolt M8x20 tornillo M8x20 Schrauben M8x20 皿ボルト M8x20		=	RFTR249	
Poggiapiede snodato Folding footpeg Estribera de apoyo abatible basculante Klappbare Raste 可倒式 ステップバー	+	vite M8x25 bolt M8x25 tornillo M8x25 Schrauben M8x25 皿ボルト M8x25		=	RFTR250	
Poggiapiede snodato Folding footpeg Estribera de apoyo abatible basculante Klappbare Raste 可倒式 ステップバー	+	vite M8x40 bolt M8x40 tornillo M8x40 Schrauben M8x40 皿ボルト M8x40		=	RFTR251	
Poggiapiede snodato Folding footpeg Estribera de apoyo abatible basculante Klappbare Raste 可倒式 ステップバー	+	vite testa cilindrica M8x20 cylindrical head bolt M8x20 tornillo cabeza cilindrica M8x20 Schrauben mit Zylinderkopt M8x20 キャップボルト M8x20		=	RFTR252	



TRACK USE

Poggiapiede fisso

Fixed footpeg - Estribera de apoyo fijo - Feste Raste - 固定式 ステップバー

Available colours



	Code	for piece
Poggiapiede fisso Fixed footpeg Estribera de apoyo fijo Feste Raste 固定式 ステップバー	RFTR318SIL	

COMPONENTI RICAMBIO PER PEDANE

REAR SET SPARE PARTS - COMPONENTES DE RECAMBIO ESTRIBERAS - ERSATZTEILE FÜR FUSSRASTENANLAGEN - ステップ キット スペアパーツ

Fitting bolts
NOT INCLUDED!



Supporto poggiapiede
Footpeg holder
Soporte apoyapie
Träger für Rasten
ステップバーホルダー シフト側 / ブレーキ側 兼用

FTR704

Fitting bolts
NOT INCLUDED!



Supporto poggiapiede
Footpeg holder
Soporte apoyapie
Träger für Rasten
ステップバーホルダー シフト側 / ブレーキ側 兼用

FTR745

* Always check compatibility

Fitting bolts
NOT INCLUDED!



Supporto poggiapiede
Footpeg holder
Soporte apoyapie
Träger für Rasten
ステップバーホルダー シフト側 / ブレーキ側 兼用

FTR746

* Always check compatibility



Fitting bolts
NOT INCLUDED!

Kit supporti poggiapiedi "UP&DOWN" per avere più combinazioni di regolazione
Supports kit for footpegs "UP&DOWN" to allow multiple combinations
Kit soportes estribo "UP-DOWN" para tener mas combinaciones de regulacion
Kit Halterung für die Raste, um mehr Verstell Möglichkeiten zu haben
上下のポジション選択を可能にする、フットペグ用サポートキット

Available colours: ● ● ● ●

RFTR244*

for kit

* Always check compatibility



Fitting bolts
NOT INCLUDED!

Supporto poggiapiede lato freno
Footpeg holder brake side
Soporte apoyapie lado freno
Träger für Fussraste Bremsseite
ステップバーホルダー ブレーキ側

Available colours: ● ● ●

FTR507



Fitting bolts
NOT INCLUDED!

Supporto poggiapiede lato cambio
Footpeg holder shift side
Soporte apoyapie lado freno
Träger für Fussraste Schaltseite
ステップバーホルダー シフト側

Available colours: ● ● ●

FTR508

Esempi di possibili configurazioni
 Examples of possible configurations
 Ejemplos de posibles configuraciones
 Beispiele für möglichen Konfigurationen
 ポジション選択パターン一覧

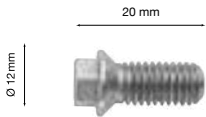
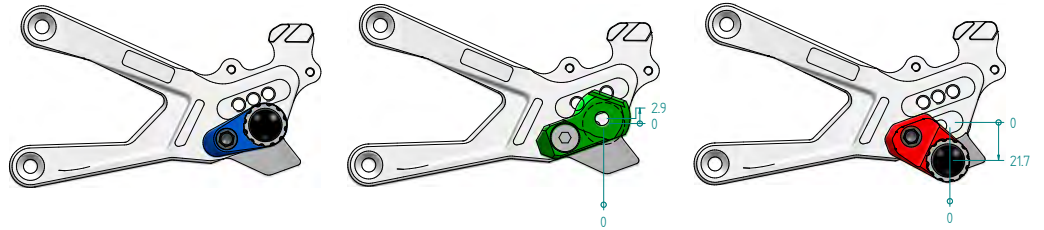

Vite per FTR704/RFTR244
 Bolt for FTR704/RFTR244
 Tornillo para FTR704/RFTR244
 Schraube für FTR704/RFTR244
 ステップバーホルダー FTR704/RFTR244 用 ボルト

FTR690

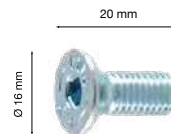

Vite per FTR507/FTR508
 Bolt for FTR507/FTR508
 Tornillo para FTR507/FTR508
 Schraube für FTR507/FTR508
 ステップバーホルダー FTR507 / FTR508 用 ボルト

V005M8020ZB

M8 x 25
V005M8025ZB
 Vite per fissaggio piastre pedana
 Bolts for fixing the rear set plates
 Tornillo para fijar placas de estriberas
 Schraube zur Befestigung der Fussrastenplatten
 ステップバーホルダー専用特殊ボルト



FTR760

Vite special per fissaggio piastre pedana
 Special bolt for fixing rear set plates
 Tornillo especial para fijar las placas de los estriberas
 Spezialschraube zur Befestigung von Fussrastenplatten
 ステップバーホルダー専用特殊ボルト



COMPONENTI RICAMBIO PER PEDANE

REAR SET SPARE PARTS - COMPONENTES DE RECAMBIO ESTRIBERAS - ERSATZTEILE FÜR FUSSRASTENANLAGEN - ステップ キット スペアパーツ

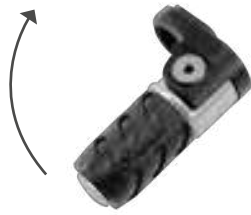

Puntalino snodato
Folding front toe peg
Puntera abatible
Gelenkschaltspitze
可倒式 フロントトゥー ペグ

RFTR322



Puntalino snodato
Folding front toe peg
Puntera abatible
Gelenkschaltspitze
可倒式 フロントトゥー ペグ

RFTR323



Puntalino
Front toe peg
Puntera
Schaltspitze
フロントトゥー ペグ

RFTR52



Aluminium

Puntalino snodato
Folding front toe peg
Puntera abatible
Gelenkschaltspitze
可倒式 フロントトゥー ペグ

RFTR213SIL



Aluminium

Puntalino snodato
Folding front toe peg
Puntera abatible
Gelenkschaltspitze
可倒式 フロントトゥー ペグ

RFTR214SIL



Supporto puntalino
Toe peg holder
Soporte puntera
Unterlagscheibe für Schaltspitze
トゥー ペグ ホルダー

FTR290NER

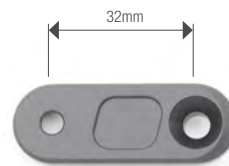

Supporto puntalino
Toe peg holder
Soporte puntera
Unterlagscheibe für Schaltspitze
トゥー ペグ ホルダー

FTR799NER

Millerighe
Gear shift arm
Acanalado
Gerippt
ギアシフトアーム



FTR236NER

Millerighe
Gear shift arm
Acanalado
Gerippt
ギアシフトアーム



FTR429NER

Uniball ピロボール

Mas M6 Right
Mas M6 Left



VAR1036
VAR1077

Uniball ピロボール

Fem M6 Right
fem M6 Left



VAR1095
VAR1076

M10 x 1,25

Interruttore stop idraulico
Hydraulic stop switch
Interruptor freno hidraulico
Stopschalter hydraulisch
油圧 ストップ スイッチ



RFTR93

M10 x 1

Interruttore stop idraulico
Hydraulic stop switch
Interruptor freno hidraulico
Stopschalter hydraulisch
油圧 ストップ スイッチ



RFTR128

Alluminio/Aluminium/Aluminio/Aluminium/アルミニウム

- mm 100 FTR741NER
- mm 110 FTR734NER
- mm 120 FTR742NER
- mm 130 FTR495NER
- mm 140 FTR518NER
- mm 155 FTR75NER
- mm 165 FTR252NER
- mm 180 FTR184NER
- mm 190 FTR62NER
- mm 197 FTR97NER
- mm 205 FTR163NER
- mm 220 FTR238NER
- mm 240 FTR32NER
- mm 255 FTR943NER



Inox/Stainless steel/Inox/Stahl/ステンレス

- mm 85 FTR669
- mm 100 FTR666
- mm 130 FTR644
- mm 145 FTR546
- mm 165 FTR329
- mm 175 FTR228
- mm 190 FTR56



COMPONENTI RICAMBIO PER PEDANE

REAR SET SPARE PARTS - COMPONENTES DE RECAMBIO ESTRIBERAS - ERSATZTEILE FÜR FUSSRASTENANLAGEN - ステップ キット スペアパーツ



Paratacco in composito
Composite heel guard
Protector en composite/polimero
Fersenschoner in Kompositmaterial
コンポジット ヒールガード (複合素材)

FTR959

FTR960



Paratacco in carbonio
Carbon heel guard
Protectores en carbono
Fersenschützer in Carbon
カーボン ヒールガード

FTR985

FTR986

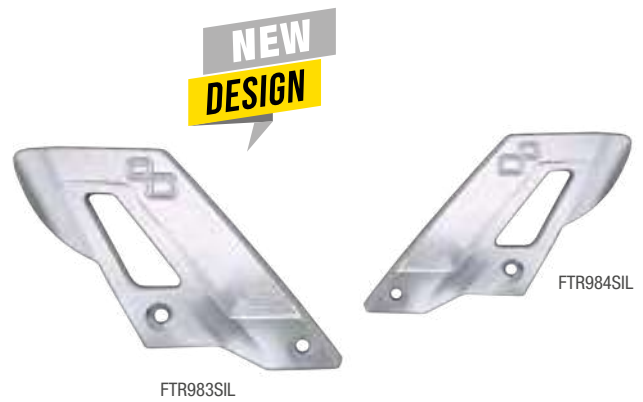

Paratacco in alluminio
Aluminium heel guard
Protectores en aluminio
Fersenschützer in aluminium
アルミニウム ヒールガード

FTR983SIL

FTR984SIL





WARNING!

Le due serie **non sono intercambiabili**
 The two series are **not interchangeable**
 Las dos series **no son intercambiables**
 Die beiden Serien sind **nicht austauschbar**
 各形状のヒールガードは互換性がありません。

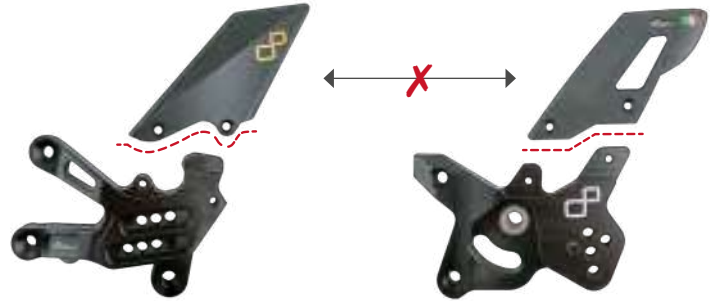

FTR795



FTR796

Paratacco in carbonio
 Carbon heel guard
 Protectores en carbono
 Fersenschützer in Carbon
 カーボン ヒール ガード

FTR795

FTR796



FTR468NER



FTR469NER

Paratacco in magnesio
 Magnesium heel guard
 Protectores en magnesio
 Fersenschützer in Magnesium
 マグネシウム ヒール ガード

FTR468NER

FTR469NER

ASTA CAMBIO A SGANCIO RAPIDO - QUICK RELEASE SHIFT ROD

BARRA CAMBIO CON CIERRE RAPIDO - SCHNELLSPANNER-SCHALTSTANGE - クイックリリース シフトロッド

NEW DESIGN



Measure	Code	Price
mm 100	FTRQR001	
mm 110	FTRQR002	
mm 120	FTRQR003	
mm 130	FTRQR004	
mm 140	FTRQR005	
mm 150	FTRQR006	
mm 160	FTRQR007	
mm 180	FTRQR008	
mm 190	FTRQR009	
mm 200	FTRQR010	

BORN
TO BE
MOTO



Yamaha MT-09



POGGIAPIEDI PER PEDANE ORIGINALI
FOOTPEGS FOR ORIGINAL REAR SETS
ESTRIBO PARA ESTRIBERAS ORIGINALES
RASTEN FÜR ORIGINALE FUSSRASTENANLAGE
純正用ステップバー

POGGIAPIEDI PER PEDANE ORIGINALI

FOOTPEGS FOR ORIGINAL REAR SETS - ESTRIBO PARA ESTRIBERAS ORIGINALES - RASTEN FÜR ORIGINALE FUSSRASTENANLAGE - 純正用ステップバー



FTP100

for pair

*Necessitano di adattatori specifici - Specific adaptors required - Se necesita adaptadores específicos - Spezielle Adapter sind notwendig - 専用アダプターが必須です。

Year	Code	Code	Price
			
	FRONT	REAR	for pair

BMW

R Nine-T /Scrambler/Pure/Urban/Racer	16	18	-	FTP029	
NEW S1000 R	XXX	23	-	FTP026	
S1000RR	15	18	FTP025	FTP026	

HONDA

CB 125R	18	23	FTP012	FTP007	
CB 600 Hornet	07	13	FTP012	FTP007	
CB 650 F	14	23	FTP012	FTP007	
CB 1000R / ABS	08	17	FTP002	FTP007	
CB 1000R	18	23	FTP012	FTP007	
CBR 600F	11	14	FTP012	FTP007	
CBR 600RR / ABS	03	16	FTP002	FTP007	
CBR 1000RR	04	13	FTP002	FTP007	
CBR 1000RR-R	20	23	-	FTP007	
Integra	15	17	-	FTP007	

	Year		Code	Code	Price
			FRONT	REAR	for pair
KAWASAKI					
ER6 F/N	06	08	FTP003	FTP009	
NEW Z400	18	23	-	FTP009	
Z650	17	23	FTP031	FTP009	
Z750/R	04	12	FTP003	FTP009	
Z800	13	16	FTP003	FTP009	
Z900	17	23	FTP031	FTP009	
Z1000	03	09	FTP003	FTP009	
Z1000	10	20	FTP004	FTP009	
Z1000SX	11	20	FTP003	FTP009	
ZX6-R	05	06	FTP003	FTP009	
ZX6-R	07	21	FTP004	FTP009	
ZX10R	08	10	FTP004	FTP009	
ZX10R	11	23	-	FTP009	

MV					
Brutale 675/800	12	16	FTP014	FTP015	
Brutale 920	10	11	FTP014	FTP015	
Brutale 1090-R /RR/Corsa	12	13	FTP014	FTP015	
Dragster	14	16	FTP014	FTP015	
F3 675/800/AGO	12	18	FTP014	FTP015	
F4-S/R/RR	13	18	FTP014	FTP015	
Rivale	14	16	FTP014	FTP015	
Stradale	15	16	FTP014	FTP015	

SUZUKI					
GSR600	06	10	FTP005	FTP008	
GSR750	11	16	FTP005	FTP008	
GSX1300 Hayabusa	08	14	FTP005	FTP008	
GSX-R 600	08	17	FTP005	FTP008	
GSX-R 750	08	17	FTP005	FTP008	
GSX-R 1000	09	23	FTP005	FTP008	
GSX-S 125	17	21	FTP005	FTP008	
GSX-S 750	17	20	FTP005	FTP008	
GSX-S 1000	15	23	FTP005	FTP008	
Katana	19	23	FTP005	FTP008	
SFV 650 Gladius	09	14	FTP005	FTP008	

TRIUMPH					
Speed Triple/ R	11	20	FTP010	FTP030	
NEW Speed Triple RS 1200	XXX	XXX	-	FTP030	
Street Triple/R/Daytona	11	20	FTP010	FTP030	

YAMAHA					
FZ1/Fazer	06	12	-	FTP022	
FZ8/Fazer	11	13	-	FTP022	
MT-03	16	17	FTP019	-	
MT-07	14	23	FTP019	FTP022	
NEW Tracer 7 / Tracer 7 GT	20	23	FTP002	FTP034	
MT-09	14	20	FTP019	FTP022	
MT-09	21	23	-	FTP032	
MT-10	16	21	FTP019	FTP022	
T-MAX	03	23	-	FTP022	
YZF-R1	09	14	-	FTP021	
YZF-R1	15	23	FTP027	FTP028	
YZF-R3	15	23	-	FTP022	
YZF-R6	06	23	FTP016	FTP021	

**BORN
TO BE
MOTO**



Team SpeedUp
Alonso López



Team SpeedUp
#54 Fermín Aldeguer
#21 Alonso López



TENDITORI CATENA
CHAIN ADJUSTERS
TENSOR CADENA
KETTENSPANNER
チェーンアジャスター

TENDITORI CATENA

CHAIN ADJUSTERS - TENSOR CADENA - KETTENSPANNER - チェーンアジャスター



FAST AND ACCURATE

Regolazione esterna a vite per una **regolazione veloce e precisa**
 External bolt allows **precise adjustment** first time every time
 Regulación externa a rosca para una **regulación rápida y precisa**
 Schraube zur **präzisen und schnellen Verstellung** der Kettenspannung
 外部アジャスターボルトにより、精密なチェーン調整が可能

Forchetta disponibile come **optional** per l'utilizzo di cavalletti a rulli

Lifters (**supplied as option**) allows you to use spool-type rear stands for a more secure lift

Horquilla **como accesorio**, para el uso del caballete a rodillo

Optionale Gabel zur Aufnahme für Motorradständer mit Rollensystem

専用スタンドフック(別売り)を使用することにより、より確実に車体をリフトすることができます

Scala graduata incisa al laser

Metric scale is stamped into the alloy

Escala graduada marcada al laser

Millimeterskala in Laserprägung

刻印タイプの精密調整メモリ



Realizzato in **ergal 7075**

CNC machined from billet **Ergal 7075**

Fabricado en **Ergal 7075**

Hergestellt in **Ergal 7075**

ジュラルミン 7075 削りだしパーツ



Permette uno spostamento di **0,25mm ad ogni click**

To adjust simply turn the small adjuster: **1 click = 0.25mm**

Permite una regulación de 0,25 mm por cada click

Einstellschraube rastet hörbar in **0,25 mm Schritte**

シンプルで精密なアジャスターボルト調整式機構 (1 click = 0.25mm)

APRILIA



RSV4 R / FACTORY / APRC Year: 09-14
TUONO V4 Year: 11-14

TEAP001

Available colours: ● ●



RSV4 RR / RF / APRC Year: 15-20
RSV4 1100 FACTORY Year: 19-20
TUONO V4 / 1100 FACTORY Year: 15-20

TEAP003

Available colours: ● ●



RS 660 / TUONO 660 Year: 20-24

TEAP004

Available colours: ● ●



RSV4 1100 FACTORY Year: 21-24
TUONO V4 1100 Year: 21-24

TEAP005

Available colours: ● ●

Configurazione standard - Standard configuration - Configuración estándar
Standardkonfiguration - スイングアームの前方位置で使用可能



RSV4 1100 FACTORY Year: 21-24

TEAP006

Available colours: ● ●

Configurazione arretrata - Backward configuration Configuración atrasada
Rückwärtskonfiguration - スイングアームの後方位置で使用可能 (レース用)

**NEW
DESIGN**



TENDITORI CATENA

CHAIN ADJUSTERS - TENSOR CADENA - KETTENSANNER - チェーンアジャスター

BMW

**S1000 R** Year: 14-20**S1000 RR** Year: 09-18

TEBM002

Available colours: ● ● ● ●

**M1000 R** Year: 22-24**S1000 R** Year: 21-23**S1000 RR** Year: 19-23

TEBM003

Available colours: ● ● ● ●

HONDA

**CBR 600RR** Year: 07-17**CBR 1000RR** Year: 08-16

TEH002

Available colours: ● ●

**CBR 1000RR-R / SP** Year: 20-24

TEH004

Available colours: ● ●

**XADV** Year: 17-23

TEH003

Available colours: ● ● ●

KAWASAKI



Z900 Year: 17-23

TEKA004

Available colours: ● ● ●



* **ZX6R / 636** Year: 09-21

TEKA005

Available colours: ● ● ●



* **ZX10R** Year: 11-15

TEKA003

Available colours: ● ● ●



* **ZX10R** Year: 16-24

TEKA002

Available colours: ● ● ●

* Si consiglia di sostituire il dado perno ruota originale con un dado **ribassato**
We recommend to change the OEM wheel nut with a **lower one**
Se aconseja de cambiar la tuerca del eje rueda original por una **rebajada**
Wir raten die Mutter der Radachse mit einer **sehr niedrigen** Mutter zu ersetzen
本製品装着時には、薄型のホイールナットへの交換をおすすめします*



M 24x1,5

* Dado ribassato in titanio
Titanium lower nut
Tuerca rebajada en titanio
Niedrigen Mutter aus Titan
コンボジットヒールガード (複合素材)

D024

SUZUKI

**GSX-R 600 / 750** Year: 11-17

TESU004

Available colours: ● ● ●

**GSX-R 1000** Year: 09-16

TESU009

Available colours: ● ● ●

**GSX-R 1000 / R** Year: 17-24

TESU008

Available colours: ● ● ●

**GSX-S 950** Year: 21-23**GSX-S 1000 / GT** Year: 15-23

TESU007

Available colours: ● ● ●

Regolazione esterna a vite per una **regolazione veloce e precisa**
 External bolt allows **precise adjustment** first time every time
 Regulación externa a rosca para una **regulación rápida y precisa**
 Schraube zur **präzisen und schnellen Verstellung** der Kettenspannung
 外部アジャスターボルトにより、精密なチェーン調整が可能



YAMAHA

**T-MAX 530 - 560** Year: 12-24

TEYA001

Available colours: ● ● ● ●

**MT-09** Year: 13-16**MT-09 TRACER / XSR900** Year: 13-20

TEYA002

Available colours: ● ●

**MT-09 / SP / TRACER 9 / TRACER 9 GT** Year: 21-24

TEYA010

Available colours: ● ● ● ●

**MT-10** Year: 16-21**R1 / R1 M** Year: 15-19

TEYA003

Available colours: ● ● ● ●

**R1** Year: 09-14

TEYA004

Available colours: ● ● ● ●

TENDITORI CATENA

CHAIN ADJUSTERS - TENSOR CADENA - KETTENSPANNER - チェーンアジャスター

YAMAHA

**R1 / R1 M** Year: 20-24

TEYA005

Available colours: ● ● ● ●

**R1 / R1 M** Year: 20-24 **TRACK USE**

TEYA009

Available colours: ● ●

Configurazione arretrata - Backward configuration Configuración atrasada
Rückwärtskonfiguration - スイングアームの後方位置で使用可能 (レース用)Supporto pinza freno - Brake Caliper Support - Soporte pinza de freno
Bremssattelhalterung - ブレーキキャリパーサポート**NEW
DESIGN****R6** Year: 06-16

TEY608

Available colours: ● ● ● ●

**R6** Year: 17-24

TEYA006

Available colours: ● ● ● ●

Supporto pinza freno - Brake caliper support - Soporte de pinza de freno
Unterstützung für Bremssattel - ブレーキキャリパーサポート**R6** Year: 17-24

TEYA008

Available colours: ● ●



I VANTAGGI DELLA FORCHETTA RACING
THE ADVANTAGES OF RACING LIFTER / VENTAJAS DE LA HORQUILLA RACING
DIE VORTEILE DER RACING GABEL / レーシングスタンドフックのメリット

- 1.** Innesto rapido del cavalletto
 Quick lift for rear stand use
 Acople rapido del caballete
 Schnelle Kupplung des Ständer
 素早いリフトアップ
- 2.** Evita rotture del forcellone in caso di scivolate
 Avoid damage for swingarm in case of slide
 Evita la rotura del basculante en el caso de una mal acoplamiento
 Sie kann Brüche des Motorrad Schwingarm im Fall von ausrutschen vermeiden
 転倒時にスウィングアームを保護
- 3.** Impiegando il cavalletto a rulli, si evitano graffi accidentali.
 Avoid scratches if used with rear stand with rollers.
 Usando el caballete con rodillo se evita ralladas accidentales.
 Beim benutzen des Rollenständer kann man Kratzer ausschliessen.
 メンテナンススタンド使用時に損傷を防ぐ



Available colours: ●

	Year		Code	Price	Compatible with
APRILIA					
RS 660	20	24	FTEAP004		TEAP004
RSV4 R / Factory / APRC	09	14	FTEAP001		TEAP001
RSV4 RR / RF / APRC / 1100 Factory	15	20	FTEAP002		TEAP003
RSV4 1100 Factory	21	24	FTEAP005		TEAP005
RSV4 1100 Factory	21	24	FTEAP005		TEAP001
TUONO V4	11	14	FTEAP001		TEAP001
TUONO V4 / 1100 Factory	15	20	FTEAP002		TEAP003
TUONO V4 / 1100 Factory	21	24	FTEAP005		TEAP005
BMW					
M1000 R	22	24	FTEBM003		TEAP001
S1000 R	09	20	FTEBM002		TEBM002
S1000 R	21	23	FTEBM003		TEBM003
S1000 RR	09	18	FTEBM002		TEBM002
S1000 RR	19	24	FTEBM003		TEBM003
HONDA					
CBR 600 RR	07	17	FTEH002		TEH002
CBR 1000 RR	06	16	FTEH002		TEH002
CBR 1000RR-R / SP	20	24	FTEH004		TEH004
KAWASAKI					
ZX6R	09	20	FTEKA005		TEKA005
ZX10R	16	24	FTEKA007		TEKA002
SUZUKI					
GSXR 1000 / R	17	23	FTESU002		TESU008
YAMAHA					
MT-10	16	21	FTEYA003		TEYA003
R1	09	14	FTEYA004		TEYA004
R1 / R1 M	15	19	FTEYA003		TEYA003
R1 / R1 M	20	24	FTEYA005		TEYA005
R1 / R1 M	20	24	FTEYA005		TEYA009
R6	17	24	FTEYA006		TEYA006

FORCHETTE INDIPENDENTI

INDEPENDENT LIFTERS - HORQUILLA INDEPENDIENTE - UNABHÄNGIGE GABEL - スタンドフック

FTEH0001



FTEYA009

FTEKA006



FTEYA007

		Year		Code	Price
for pair					
HONDA					
CBR1000RR-R	●	20	23	FTEH0001	
KAWASAKI					
ZX10R	●	16	23	FTEKA006	
YAMAHA					
MT-10	●●●●	16	22	FTEYA007	
R3	●	15	23	FTEYA009	
R1	●●●●	15	23	FTEYA007	
R6	●●●●	17	23	FTEYA007	
R7	●●●●	22	23	FTEYA007	

NEW!



FTEYA007



**NEW
DESIGN**



Measure		Code	Color	Price
M6	Aprilia* / Ducati Panigale 899-959* / Triumph* / Yamaha*	SCV003	●●●●●●	for pair
M8	Bmw* / Honda* / Kawasaki, Suzuki* / Triumph 675-765*	SCV004	●●●●●●●	
M10 X 1,25	CF Moto* / Kawasaki*	SCV005	●●●●●●●	
M10 x 1,50	KTM* / Moto Morini*	SCV006	●●●	

* Always check compatibility モデルにより異なりますので必ずご確認ください

**BORN
TO BE
MOTO**



Ducati Panigale V2



PORTA TARGA
LICENSE PLATE HOLDER
PORTAMATRICULA
KENNZEICHENHALTER
ナンバープレートホルダー

PORTA TARGA REGOLABILI

ADJUSTABLE LICENSE PLATE HOLDERS / PORTAMATRICULAS REGULABLE / VERSTELLBARE KENNZEICHENHALTER / アジャスタブルナンバープレートホルダー

EASY
and **FAST**Distanziali attacco SLIM
Spacers for joint SLIM
Separador SLIM
Abstandshalter für Befestigung SLIM
スリムジョイント用スペーサーSupporto per portatarga e luce targa
Support for tail tidy and plate light
Soporte para el porta matricula y luz de matricula
Halterung für Kennzeichenhalter und Beleuchtung
プレートホルダー及びプレートライト用サポートMateriale composito ad alta resistenza
High-resistance composite material
Material composite de alta resistencia
Widerstandfähiges composite Material
超強度構造Semplicità nel montaggio
Easy to assembly
Montaje facil y sencillo
Einfachheit der Montage
簡単組み立てSupporti frecce regolabili
Adjustable supports for turn signals
Soporte para intermitentes regulable
Verstellbare Halterungen für Blinker
ウインカー用アジャスタブルサポートSupporto catadiottro regolabile
Adjustable support for retroreflector
Soporte para catadioptico regulable
Verstellbare Halterung für Rückstrahler
リフレクター用アジャスタブルサポート**NEL PIENO RISPETTO DEL CODICE DELLA STRADA - FOR LEGAL STREET USE**
EN RELACIÓN A LA NORMATIVA LEGAL DE TRÁFICO - IN ÜBEREINSTIMMUNG MIT
DER STRASSENVERKEHRSORDNUNG - 公道使用対応パーツ (EU基準)

HOMOLOGATED



HOMOLOGATED





PORTA TARGA UNIVERSALE CON KIT DI APPLICAZIONE - GENERIC TAIL TIDY TO ADAPT WITH APPLICATION KIT
PORTA MATRICULAS UNIVERSAL CON KIT DE APLICACIONES - UNIVERSELLER KENNZEICHENHALTER MIT ADAPTERKIT
汎用ナンバープレートホルダー キット (車輛により要加工)



Available colour: ●

KTAR013**

Available colour: ●

TAR013**

PORTA TARGA REGOLABILI

ADJUSTABLE LICENSE PLATE HOLDERS / PORTAMATRICULAS REGULABLE / VERSTELLBARE KENNZEICHENHALTER / アジャスタブルナンバープレートホルダー



**** IMPORTANTE:** aggiungere il codice della sigla dello stato - **IMPORTANT:** add the code of the country - **IMPORTANTE:** añadir el código de la sigla del país
WICHTIG: ergänzen Sie den Code mit den Buchstaben des Staates - **注意:** ご注文時に国コードをお選びください

(see example page 95)

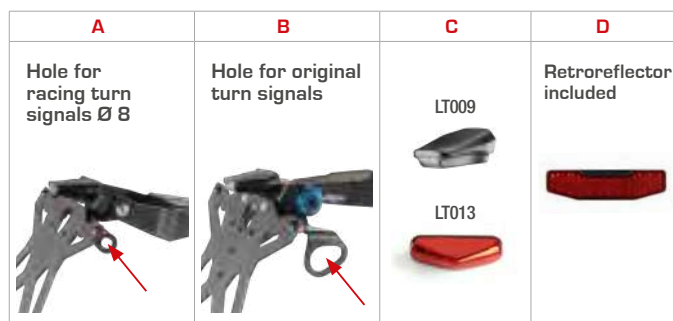

! END STOCK 廃盤

Year	Hole for turn signals		Light	Retroreflector	TÜV homologated	Code	Price
	from	to					
APRILIA							
RS 660	20	24	✓	✓	YES	KTARAP109**	kit
			✓	✓		TARAP109**	
Dorsoduro 900	17	20	✓	✓	YES	KTARAP108**	kit
			✓	✓		TARAP108**	
Dorsoduro 1200	11	15	✓	✓	NO	KTARAP108**	kit
			✓	✓		TARAP108**	
RSV4 (all versions)	09	20	✓	✓	YES	KTARAP107**	kit
			✓	✓		TARAP107**	
RSV4 1100 Factory	21	24	✓	✓	YES	KTARAP109**	kit
			✓	✓		TARAP109**	
Tuono 660	20	24	✓	✓	YES	KTARAP109**	kit
			✓	✓		TARAP109**	
Tuono V4 (all versions)	11	20	✓	✓	YES	KTARAP107**	kit
			✓	✓		TARAP107**	
Tuono V4 1100 Factory	21	24	✓	✓	YES	KTARAP109**	kit
			✓	✓		TARAP109**	
BENELLI							
BN 125	18	21	✓	✓	NO	KTARBN101**	kit
			✓	✓		TARBN101**	
BMW							
S1000 R	14	20	✓	✓	YES	KTARBM105**	kit
			✓	✓		TARBM105**	
S1000 R	21	24	—	✓	YES	KTARBM111**	kit
			—	✓		TARBM111**	
S1000 RR / HP4	09	18	✓	✓	YES	KTARBM105**	kit
			✓	✓		TARBM105**	
S1000 RR	19	24	—	✓	YES	KTARBM111**	kit
			—	✓		TARBM111**	

				A	B	C	D	! END STOCK 廃盤			
Year		Hole for turn signals		Light	Retroreflector	TÜV homologated	Code	Price			
from	to	racings	original			KBA 91919					
BMW											
M1000 R	22	24	—	✓	LT009	✓	YES	KTARBM111**		kit	
			—	✓				TARBM111**			
M1000 RR	21	24	—	✓	LT009	✓	YES	KTARBM111**		kit	
			—	✓				TARBM111**			
CF MOTO											
650 NK	21	23	✓	✓	LT009	✓	NO	KTARCF101**		kit	
			—	—				TARCF101**			
NEW 450 NK	23	24	✓	—	LT009	✓	NO	KTARCF102**		kit	
			—	—				TARCF102**			
NEW 450 SR	23	24	✓	—	LT009	✓	NO	KTARCF102**		kit	
			—	—				TARCF102**			
DUCATI											
848 - 1098 - 1198	07	11	✓	✓	LT009	✓	NO	KTARDU104**		kit	
			✓	✓				TARDU104**			
Hypermotard 796 - 1100	07	12	✓	—	LT009	✓	NO	KTARDU105**		kit	
			✓	—				TARDU105**			
Hypermotard 821 / 939	13	18	✓	—	LT009	✓	YES	KTARDU110**		kit	
			✓	—				TARDU110**			
Hypermotard 950 / SP	19	23	✓	✓	LT009	✓	YES	KTARDU114**		kit	
			✓	✓				TARDU114**			
Monster 797	17	20	✓	✓	LT009	✓	YES	KTARDU112**		kit	
			✓	✓				TARDU112**			
Monster 937	21	24	✓	✓	LT009	✓	YES	KTARDU115**		kit	
			✓	✓				TARDU115**			
Monster 1200 / S / R	17	21	✓	✓	LT009	✓	YES	KTARDU112**		kit	
			✓	✓				TARDU112**			
Multistrada V4 / S	21	23	✓	✓	LT009	✓	NO	KTARDU116**		kit	
(NOT COMPATIBLE for bike equipped with radar)			✓	✓				TARDU116**			
Multistrada V4 / S	21	23	✓	✓	LT009	✓	NO	KTARDU117**		kit	
(COMPATIBLE for bike equipped with radar)			✓	✓				TARDU117**			
NEW Multistrada V4 / S	21	23	✓	✓	LT009	✓		KTARDU118**		kit	
(COMPATIBLE for bike equipped with radar)			✓	✓				TARDU118**			
Panigale 899	12	17	✓	✓	LT009	✓	YES	KTARDU109**		kit	
			✓	✓				TARDU109**			
Panigale 959	16	20	✓	✓	LT009	✓	YES	KTARDU109**		kit	
			✓	✓				TARDU109**			
Panigale 1199 / 1299 R / S / Superleggera	12	17	✓	✓	LT009	✓	YES	KTARDU109**		kit	
			✓	✓				TARDU109**			
Panigale V2 955	20	24	✓	✓	LT009	✓	YES	KTARDU113**		kit	
			✓	✓				TARDU113**			
Panigale V4 / S / R / Speciale	18	24	✓	✓	LT009	✓	YES	KTARDU113**		kit	
			✓	✓				TARDU113**			

PORTA TARGA REGOLABILI

ADJUSTABLE LICENSE PLATE HOLDERS / PORTAMATRICULAS REGULABLE / VERSTELLBARE KENNZEICHENHALTER / アジャスタブルナンバープレートホルダー

	Year		Hole for turn signals		A	B	C	D	TÜV homologated	Code	Price
	from	to	racing	original							
DUCATI											
Supersport 939 / S	17	20	✓	✓	LT009	✓			YES	KTARDU112**	kit
			✓	✓						TARDU112**	
Supersport 950 / S	21	22	✓	✓	LT009	✓			YES	KTARDU112**	kit
			✓	✓						TARDU112**	
Streetfighter V2 / S	21	24	✓	✓	LT009	✓			YES	KTARDU113**	kit
			✓	✓						TARDU113**	
Streetfighter V4 / S	20	24	✓	✓	LT009	✓			YES	KTARDU113**	kit
			✓	✓						TARDU113**	
FANTIC											
Caballero 125 / 250 / 500 Scrambler / Rally	19	22	✓	✓	LT009	✓			YES	KTARFA101**	kit
			✓	✓						TARFA101**	
Caballero 125 / 250 / 500 - flat track	19	22	✓	✓	LT009	✓			NO	KTARFA102**	kit
			✓	✓						TARFA102**	
HONDA											
CB 125 R / CB 300 R	18	23	✓	✓	LT009	✓			YES	KTARHO117**	kit
			✓	✓						TARHO117**	
CB 650 F	14	19	✓	—	LT009	✓			YES	KTARHO111**	kit
			✓	—						TARHO111**	
CB 650 R	19	20	✓	✓	LT009	✓			YES	KTARHO118**	kit
			✓	✓						TARHO118**	
CB 650 R	21	23	✓	✓	LT009	✓			YES	KTARHO121**	kit
			✓	✓						TARHO121**	
CB 750 Hornet	23	24	✓	✓	LT009	✓			NO	KTARHO123**	kit
			✓	✓						TARHO123**	
CB 1000R	08	17	✓	—	LT009	✓			NO	KTARHO107**	kit
			✓	—						TARHO107**	
CB 1000R	18	20	✓	✓	LT009	✓			YES	KTARHO116**	kit
			✓	✓						TARHO116**	
CBR 500R	17	24	✓	✓	LT009	✓			YES	KTARHO120**	kit
			✓	✓						TARHO120**	
CBR 600 F	11	13	✓	—	LT009	✓			NO	KTARHO108**	kit
			✓	—						TARHO108**	
CBR 650 F	14	18	✓	—	LT009	✓			YES	KTARHO111**	kit
			✓	—						TARHO111**	
CBR 650 R	19	20	✓	✓	LT009	✓			YES	KTARHO118**	kit
			✓	✓						TARHO118**	
CBR 650 R	21	23	✓	✓	LT009	✓			YES	KTARHO121**	kit
			✓	✓						TARHO121**	
CBR 1000 RR	10	16	✓	—	LT009	✓			NO	KTARHO109**	kit
			✓	—						TARHO109**	
CBR 1000 RR	17	19	✓	✓	LT009	✓			YES	KTARHO114**	kit
			✓	✓						TARHO114**	
CBR 1000 RR-R / SP	20	23	✓	✓	LT009	✓			YES	KTARHO119**	kit
			✓	✓						TARHO119**	

	Year		Hole for turn signals		Light	Retroreflector	TUV homologated	Code	Price
	from	to	racing	original					
							KBA 91919		
HONDA									
Hornet 600	11	13	✓	—	LT009	✓	NO	KTARHO108**	kit
			✓	—				TARHO108**	
Integra 750	16	18	✓	✓	LT009	✓	NO	KTARHO113**	kit
			✓	✓				TARHO113**	
X-ADV 750	17	20	—	✓	LT009	✓	YES	KTARHO115**	kit
			—	✓				TARHO115**	
NEW X-ADV 750	21	24	—	✓	LT009	✓		KTARHO124**	kit
			—	✓				TARHO124**	
HUSQVARNA									
Nuda 900	11	13	✓	✓	LT009	✓	NO	KTARHU101**	kit
			✓	✓				TARHU101**	
Vitpilen 701	18	19	✓	✓	LT009	✓	NO	KTARHU102**	kit
			✓	✓				TARHU102**	
KAWASAKI									
ER - 6N	12	20	✓	✓	LT009	✓	NO	KTARKA116**	kit
			✓	✓				TARKA116**	
Ninja 125	19	22	✓	✓	LT009	✓	YES	KTARKA125**	kit
			✓	✓				TARKA125**	
Ninja 250	18	20	✓	✓	LT009	✓	NO	KTARKA124**	kit
			✓	✓				TARKA124**	
Ninja 300	12	16	✓	—	LT009	✓	NO	KTARKA118**	kit
			✓	—				TARKA118**	
Ninja 400	17	23	✓	✓	LT009	✓	YES	KTARKA124**	kit
			✓	✓				TARKA124**	
Ninja 650	16	23	✓	✓	LT009	✓	YES	KTARKA122**	kit
			✓	✓				TARKA122**	
Ninja 1000 SX	21	23	✓	✓	LT009	✓	YES	KTARKA115**	kit
			✓	✓				TARKA115**	
Versis 650	22	23	✓	✓	LT009	✓	YES	KTARKA115**	kit
			✓	✓				TARKA115**	
Versis 1000	19	22	✓	✓	LT009	✓	YES	KTARKA115**	kit
			✓	✓				TARKA115**	
Z 125	19	22	✓	✓	LT009	✓	YES	KTARKA125**	kit
			✓	✓				TARKA125**	
Z 300	12	16	✓	—	LT009	✓	NO	KTARKA118**	kit
			✓	—				TARKA118**	
Z 400	17	23	✓	✓	LT009	✓	YES	KTARKA124**	kit
			✓	✓				TARKA124**	
Z 650	16	24	✓	✓	LT009	✓	YES	KTARKA122**	kit
			✓	✓				TARKA122**	
Z 750	07	14	✓	—	LT009	✓	NO	KTARKA109**	kit
			✓	—				TARKA109**	
Z 800	13	16	✓	—	LT009	✓	NO	KTARKA117**	kit
			✓	—				TARKA117**	

PORTA TARGA REGOLABILI

ADJUSTABLE LICENSE PLATE HOLDERS / PORTAMATRICULAS REGULABLE / VERSTELLBARE KENNZEICHENHALTER / アジャスタブルナンバープレートホルダー

	Year		Hole for turn signals		Light	Retroreflector	TÜV homologated	Code	Price
	from	to	racing	original					
							KBA 91919		
KAWASAKI									
Z 900	17	24	✓	✓	LT009	✓	YES	KTARKA123**	kit
			✓	✓				TARKA123**	
Z 1000	07	09	✓	—	LT009	✓	NO	KTARKA109**	kit
			✓	—				TARKA109**	
Z 1000	10	13	✓	✓	LT009	✓	YES	KTARKA115**	kit
			✓	✓				TARKA115**	
Z 1000	14	20	✓	—	LT009	✓	YES	KTARKA119**	kit
			✓	—				TARKA119**	
Z 1000 SX	11	20	✓	✓	LT009	✓	YES	KTARKA115**	kit
			✓	✓				TARKA115**	
Z H2	20	22	✓	✓	LT009	✓	YES	KTARKA123**	kit
			✓	✓				TARKA123**	
NEW ZX 4 RR	24	24	✓	✓	LT009	✓		KTARKA125**	kit
			✓	✓				TARKA125**	
ZX6R / ZX636	13	17	✓	—	LT009	✓	YES	KTARKA120**	kit
			✓	—				TARKA120**	
ZX6R / 636	19	24	✓	✓	LT009	✓	YES	KTARKA126**	kit
			✓	✓				TARKA126**	
ZX10 R	08	10	✓	—	LT009	✓	NO	KTARKA120**	kit
			✓	—				TARKA120**	
ZX10 R	16	20	✓	—	LT009	✓	YES	KTARKA121**	kit
			✓	—				TARKA121**	
ZX10 R	21	24	✓	✓	LT009	✓	YES	KTARKA127**	kit
			✓	✓				TARKA127**	
KEEWAY									
RKF 125	18	22	✓	—	LT009	✓	YES	KTARKE101**	kit
			✓	—				TARKE101**	
KTM									
Duke 125 / 390	17	23	✓	✓	LT009	✓	YES	KTARKT105**	kit
			✓	✓				TARKT105**	
NEW Duke 125 / 390	24	24	✓	✓	LT009	✓		KTARKT111**	kit
			✓	✓				TARKT111**	
NEW Duke 790	18	24	✓	✓	LT013/LT009	✓	NO	KTARKT110**	kit
			✓	✓	LT013			TARKT110**	
NEW Duke 890 R / GP	20	23	✓	✓	LT013/LT009	✓	NO	KTARKT110**	kit
			✓	✓	LT013			TARKT110**	
NEW Duke 990	24	24	—	✓	LT009	✓	NO	KTARKT112**	kit
			—	✓				TARKT112**	
RC 125 / 200 / 390	17	21	✓	✓	LT009	✓	NO	KTARKT107**	kit
			✓	✓				TARKT107**	
Super Duke 1290 R	20	23	✓	✓	LT009	✓	YES	KTARKT109**	kit
			✓	✓				TARKT109**	
NEW Super Duke 1390 R / EVO	24	24	—	✓	LT009	✓	NO	KTARKT112**	kit
			—	✓				TARKT112**	

				A	B	C	D	! END STOCK 廃盤			
		Year		Hole for turn signals		Light	Retroreflector	TÜV homologated	Code	Price	
		from	to	racing	original			KBA 91919			
MORINI											
NEW	Seiemezzo STR	23	23	✓	✓	LT009	✓	YES	KTARMM102**		kit
				✓	✓				TARMM102**		
NEW	X-Cape (649)	22	24	✓	✓	LT009	✓	YES	KTARMM101**		kit
				✓	✓				TARMM101**		
MV AGUSTA											
	Brutale 675 / 800	12	16	✓	—	LT009	✓	NO	KTARMM105**		kit
				✓	—				TARMM105**		
	F3 675 / 800	12	18	✓	—	LT009	✓	NO	KTARMM104**		kit
				✓	—				TARMM104**		
	F4	10	12	✓	✓	LT009	✓	NO	KTARMM103**		kit
				✓	✓				TARMM103**		
	F4	13	16	✓	—	LT009	✓	NO	KTARMM106**		kit
				✓	—				TARMM106**		
SUZUKI											
	GSR 750	11	16	✓	—	LT009	✓	NO	KTARSU110**		kit
				✓	—				TARSU110**		
	GSX-R 125 / GSX-S 125	17	20	✓	—	LT009	✓	YES	KTARSU115**		kit
				✓	—				TARSU115**		
	GSX 250 R	17	20	✓	—	LT009	✓	YES	KTARSU114**		kit
				✓	—				TARSU114**		
	GSXR 600 / 750	11	17	—	—	LT009	✓	NO	KTARSU109**		kit
				—	—				TARSU109**		
	GSXR 1000	05	08	—	—	LT009	✓	NO	KTARSU101**		kit
				—	—				TARSU101**		
	GSXR 1000	09	16	—	—	LT009	✓	YES	KTARSU102**		kit
				—	—				TARSU102**		
	GSXR 1000 / R	17	23	—	✓	LT009	✓	YES	KTARSU113**		kit
				—	✓				TARSU113**		
	GSX S 750	17	21	✓	—	LT009	✓	YES	KTARSU111**		kit
				✓	—				TARSU111**		
NEW	GSX 8 R	24	24	✓	✓	LT013/LT009	✓		KTARSU118**		kit
				✓	✓	LT013			TARSU118**		
NEW	GSX 8 S	23	24	✓	✓	LT013/LT009	✓		KTARSU118**		kit
				✓	✓	LT013			TARSU118**		
	GSX S 950	21	22	✓	✓	LT009	✓	YES	KTARSU117**		kit
				✓	✓				TARSU117**		
	GSX S 1000	15	20	✓	—	LT009	✓	YES	KTARSU111**		kit
				✓	—				TARSU111**		
	GSX S 1000	21	24	✓	✓	LT009	✓	YES	KTARSU117**		kit
				✓	✓				TARSU117**		
	SV 650	16	24	✓	—	LT009	✓	YES	KTARSU112**		kit
				✓	—				TARSU112**		

PORTA TARGA REGOLABILI

ADJUSTABLE LICENSE PLATE HOLDERS / PORTAMATRICULAS REGULABLE / VERSTELLBARE KENNZEICHENHALTER / アジャスタブルナンバープレートホルダー

Year	Hole for turn signals		Light	Retroreflector	TÜV homologated	Code	Price		
	from	to						racing	original
TRIUMPH									
Daytona 675 / 675R	12	16	✓	✓	LT009	✓	KTARTR111**	kit	
			✓	✓			TARTR111**		
Street Triple 675 / 675R	13	16	✓	—	LT009	✓	KTARTR111**	kit	
			✓	—			TARTR111**		
Street Triple 765S / 765R / 765RS	17	24	✓	✓	LT009	✓	KTARTR111**	kit	
			✓	✓			TARTR111**		
Speed Triple 1050 / 1050R	11	15	✓	—	LT009	✓	NO	KTARTR105**	kit
			✓	—			TARTR105**		
Speed Triple 1050 / S	16	20	✓	✓	LT009	✓	YES	KTARTR107**	kit
			✓	✓			TARTR107**		
Speed Triple 1200 RS / RR	21	24	✓	✓	LT009	✓	YES	KTARTR108**	kit
			✓	✓			TARTR108**		
Trident 660	21	24	✓	✓	LT009	✓	NO	KTARTR109**	kit
			✓	✓			TARTR109**		
Trident 660 (swing arm bracket cover)	-	-	—	—	—	—	NO	TARTR109P**	kit
Kit Trident 660 KTARTR109 + TARTR109P	21	24	✓	✓	LT009	✓	NO	KTARTR110**	
YAMAHA									
Fazer 600 / FZ6	04	12	✓	✓	LT009	✓	NO	KTARYA106**	kit
			✓	✓			TARYA106**		
MT-03	15	23	✓	—	LT009	✓	YES	KTARYA120**	kit
			✓	—			TARYA120**		
MT-07	13	23	✓	✓	LT009	✓	YES	KTARYA125**	kit
			✓	✓			TARYA125**		
NEW Tracer 7 / Tracer 7 GT	20	24	✓	✓	LT009	✓	XXXXX	KTARYA134**	kit
			✓	✓			TARYA134**		
MT-09	13	16	✓	✓	LT009	✓	YES	KTARYA116**	kit
			✓	✓			TARYA116**		
MT-09 / SP	21	23	✓	✓	LT009	✓	YES	KTARYA128**	kit
			✓	✓			TARYA128**		
MT-09 Tracer / Tracer GT	15	17	✓	✓	LT009	✓	YES	KTARYA119**	kit
			✓	✓			TARYA119**		
Tracer 900 / Tracer 900 GT	18	20	✓	✓	LT009	✓	YES	KTARYA119**	kit
			✓	✓			TARYA119**		
NEW Tracer 9 / Tracer 9 GT	21	24	✓	✓	LT009	✓	YES	KTARYA130**	kit
			✓	✓			TARYA130**		
MT-10 / SP	16	22	✓	✓	LT009	✓	YES	KTARYA121**	kit
			✓	✓			TARYA121**		
NEW MT-10 / SP	23	24	✓	✓	LT009	✓		KTARYA133**	kit
			✓	✓			TARYA133**		
R 125	19	24	✓	✓	LT009	✓	YES	KTARYA126**	kit
			✓	✓			TARYA126**		
R1	04	08	✓	✓	LT009	✓	YES	KTARYA103**	kit
			✓	✓			TARYA103**		

! END STOCK 廃盤

	Year		Hole for turn signals		Light	Retroreflector	TÜV homologated	Code	Price
	from	to	racing	original					
YAMAHA									
R1	09	14	✓	✓	LT009	✓	NO	KTARYA104** TARYA104**	kit
R1 - R1M	15	24	✓	✓	LT009	✓	YES	KTARYA118** TARYA118**	kit
NEW R3	15	23	✓	—	LT009	✓	YES	KTARYA120** TARYA120**	kit
R6	06	16	✓	✓	LT009	✓	YES	KTARYA103** TARYA103**	kit
NEW R6	17	23	✓	✓	LT009	✓	YES	KTARYA122** TARYA122**	kit
R7	22	24	✓	✓	LT009	✓	YES	KTARYA131** TARYA131**	kit
Tenere 700	19	23	✓	✓	LT009	✓	YES	KTARYA127** TARYA127**	kit
XJ6	08	15	✓	✓	LT009	✓	NO	KTARYA108** TARYA108**	kit
T-Max 500 (with undertail)	08	11	—	—	LT009	✓	YES	KTARYA112** TARYA112**	kit
T-Max 500 (without undertail)	08	11	—	—	LT009	✓	NO	KTARYA113** TARYA113**	kit
T-Max 530	12	16	—	—	LT009	✓	YES	KTARYA114** TARYA114**	kit
T-Max 530 / 560	17	21	✓	✓	LT009	✓	YES	KTARYA124** TARYA124**	kit
T-Max 560	22	24	—	—	LT009	✓	YES	KTARYA132** TARYA132**	kit
ZONTES									
G1 125	20	22	✓	✓	LT009	✓	NO	KTARZO101** TARZO101**	kit

END STOCK 廃盤

KBA 91919



Kit supporti frecce aftermarket
 Aftermarket led turn signal supports kit
 Kit de soportes de aftermarket intermitentes a led
 Aftermarket Blinker Support Kit
 他社製ウインカー用サポートキット

TAR019



Staffa triangolare regolazione inclinazione
 Triangular bracket for inclination adjustment
 Soporte triangular para ajuste de inclinación
 Dreieckige Halterung zum Einstellen der Neigung
 三角ブラケット(角度調整可能)

TAR021



Kit boccole laterali
 Side bushings kit
 Kit de bujes laterales
 Seitenbuchsen-Kit
 サイドスペーサーキット

TAR022

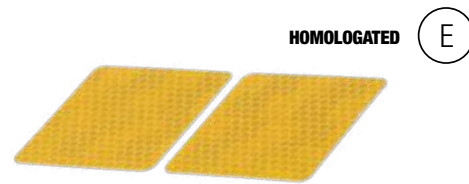

Catarifrangente adesivo laterale
 Side reflector sticker
 Reflector lateral adhesivo
 Seitlicher Reflektor aufkleber
 サイドリフレクターステッカー

50 x 50 mm | STK120

for kit

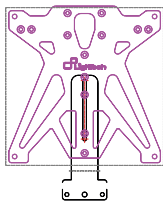

HOMOLOGATED (EU基準) E13 KAT04

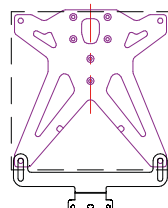

HOMOLOGATED (EU基準) E13 KAT01













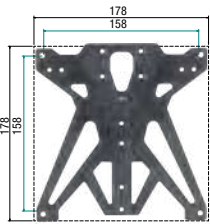

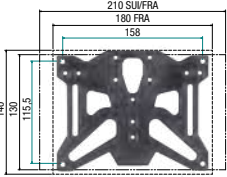

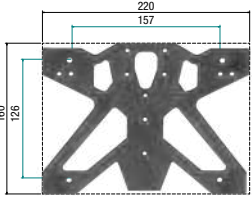
HOMOLOGATED (EU基準) E13 TAR024

Compatible with LighTech tail tidy version from 2019 →

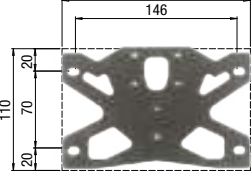
! How to create your license plate holder code

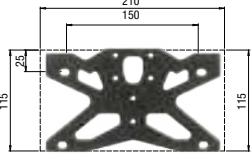
License plate holder **KIT NUMBER** + **COUNTRY CODE** = **CORRECT CODE**

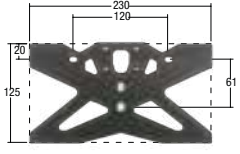
Country code	License Plate holder	Material	Code	Price
A1 { <ul style="list-style-type: none">  IT = Italia  DE = Deutschland  SLO = Slovenija 		Composit Nylon PA12 + Carbon Fiber	TAR014NER	
A2 { <ul style="list-style-type: none">  F = France  CH = Schweiz 		Composit Nylon PA12 + Carbon Fiber	TAR015NER	
A3 { <ul style="list-style-type: none">  E = España 		Composit Nylon PA12 + Carbon Fiber	TAR017NER	
B1 { <ul style="list-style-type: none">  CA = Canada  USA = United S.  P = Portugal 		Aluminium	TAR026NER	
B2 { <ul style="list-style-type: none">  KOR = Korea 		Aluminium	TAR030NER	
B3 { <ul style="list-style-type: none">  JAP = Japan 		Aluminium	TAR032NER	

CUSTOM PRODUCT FOR YOUR BIKE

Applicazioni specifiche per portatarga - Specific applications for license plate holders
 Aplicaciones específicas para portamatriculas - Spezifische Anwendungen für Kennzeichenhalter
 ナンバープレートホルダー用ボルトキット対応一覧

Code	
APRILIA	
KTARAP107	TAR025
KTARAP108	TAR025
KTARAP109	TAR025
BMW	
KTARBM105	TAR009
KTARBM111	TAR025
BENELLI	
KTARBN101	TAR025
CF MOTO	
KTARCF101	TAR025
KTARCF102	TAR025
DUCATI	
KTARDU104	TAR009
KTARDU105	TAR009
KTARDU109	TAR008
KTARDU110	TAR009
KTARDU112	TAR029
KTARDU113	TAR008
KTARDU114	TAR025
KTARDU115	TAR025
KTARDU116	TAR009
KTARDU117	TAR025
KTARDU118	TAR025
FANTIC	
KTARFA101	TAR025
KTARFA102	TAR009
HONDA	
KTARHO107	TAR009
KTARHO108	TAR009
KTARHO109	TAR009
KTARHO110	TAR009
KTARHO111	TAR009
KTARHO113	TAR009
KTARHO114	TAR025
KTARHO115	TAR025
KTARHO116	TAR025
KTARHO117	TAR025
KTARHO118	TAR025
KTARHO119	TAR025
KTARHO120	TAR025
KTARHO121	TAR025
KTARHO124	TAR025
HUSQVARNA	
KTARHU101	TAR009
KTARHU102	TAR025

Code	
KAWASAKI	
KTARKA109	TAR009
KTARKA115	TAR009
KTARKA116	TAR009
KTARKA118	TAR009
KTARKA119	TAR009
KTARKA120	TAR009
KTARKA121	TAR009
KTARKA122	TAR025
KTARKA123	TAR025
KTARKA124	TAR025
KTARKA125	TAR025
KTARKA126	TAR025
KTARKA127	TAR025
KEEWAY	
KTARKE101	TAR025
KTM	
KTARKT105	TAR025
KTARKT107	TAR025
KTARKT109	TAR008
KTARKT110	TAR009
KTARKT111	TAR025
MOTO MORINI	
KTARMM101	TAR009
KTARMM102	TAR025
MV AUGUSTA	
KTARMV103	TAR009
KTARMV104	TAR025
KTARMV105	TAR009
KTARMV106	TAR025
SUZUKI	
KTARSU101	TAR009
KTARSU102	TAR029
KTARSU109	TAR009
KTARSU110	TAR009
KTARSU111	TAR009
KTARSU112	TAR009
KTARSU113	TAR025
KTARSU114	TAR025
KTARSU115	TAR025
KTARSU117	TAR009
KTARSU118	TAR009

Code	
TRIUMPH	
KTARTR105	TAR009
KTARTR107	TAR009
KTARTR108	TAR025
KTARTR109	TAR009
KTARTR110	TAR025
KTARTR111	TAR025
YAMAHA	
KTARYA103	TAR009
KTARYA104	TAR009
KTARYA108	TAR009
KTARYA109	TAR009
KTARYA112	TAR009
KTARYA113	TAR009
KTARYA114	TAR009
KTARYA116	TAR025
KTARYA118	TAR008
KTARYA119	TAR025
KTARYA120	TAR009
KTARYA121	TAR009
KTARYA122	TAR025
KTARYA124	TAR009
KTARYA125	TAR025
KTARYA126	TAR025
KTARYA127	TAR025
KTARYA128	TAR025
KTARYA130	TAR025
KTARYA131	TAR009
KTARYA132	TAR025
KTARYA133	TAR009
KTARYA134	TAR025
ZONTES	
KTARZO101	TAR009

Kit viti - Bolt kit - Kit tornilleria Schrauben Sets - ボルトキット

		for piece
005M8x25 + RCM8	TAR009	
005M8x35 + RCM8	TAR008	
005M8x40 + RCM8	TAR025	



LUCI
LIGHTS
LUCES
BELEUCHTUNG
ライト



INDICATORI DI DIREZIONE A LED

LED TURN SIGNALS - INTERMITENTES A LED - BLINKER - LED ウィンカー

Katana



SEQUENTIAL LIGHT

Coppia frecce a led / Pair of led turn signals
 Juego de intermitentes en led / Paar Led Blinker / LED ウィンカー (ペア)

Material: ABS
 Homologated: E8

- Lightech patented
- Tecnologia innovativa MULTI-PIXEL
 Innovative MULTI-PIXEL technology
 Tecnologia innovadora MULTI PIXEL
 Innovative MULTI-PIXEL-Technologie
 マルチピクセルLED採用

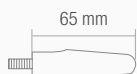

■ Indicators

FRE933NER

for pair

SeagullWing



Coppia frecce a led / Pair of led turn signals
 Juego de intermitentes en led / Paar Led Blinker / LED ウィンカー (ペア)

Material: ABS
 Homologated: E8

- Lightech patented
- Tecnologia innovativa MULTI-PIXEL
 Innovative MULTI-PIXEL technology
 Tecnologia innovadora MULTI PIXEL
 Innovative MULTI-PIXEL-Technologie
 マルチピクセルLED採用

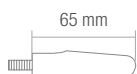

■ Indicators

FRE931NER

for pair



Coppia frecce a led / Pair of led turn signals
Juego de intermitentes en led / Paar Led Blinker / LED ウィンカー (ペア)

MonsterEye¹

Material: ABS
Homologated: E8

- Lightech patented
- Tecnologia innovativa MULTI-PIXEL
Innovative MULTI-PIXEL technology
Tecnologia innovadora MULTI PIXEL
Innovative MULTI-PIXEL-Technologie
マルチピクセルLED採用

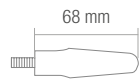

■ Indicators

FRE932NER

for pair



Coppia frecce a led / Pair of led turn signals
Juego de intermitentes en led / Paar Led Blinker / LED ウィンカー (ペア)

MonsterEye²

Material: ABS
Homologated: E8

- Lightech patented
- Tecnologia innovativa MULTI-PIXEL
Innovative MULTI-PIXEL technology
Tecnologia innovadora MULTI PIXEL
Innovative MULTI-PIXEL-Technologie
マルチピクセルLED採用

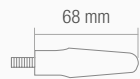

■ Indicators

Front WHITE light

FRE934NER

for pair



Coppia frecce a led / Pair of led turn signals
Juego de intermitentes en led / Paar Led Blinker / LED ウィンカー (ペア)

MonsterEye³

Material: ABS
Homologated: E8

- Lightech patented
- Tecnologia innovativa MULTI-PIXEL
Innovative MULTI-PIXEL technology
Tecnologia innovadora MULTI PIXEL
Innovative MULTI-PIXEL-Technologie
マルチピクセルLED採用

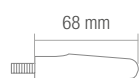

■ Indicators - ウィンカー

■ Rear RED Light - テールライト

■ Brake Light - ブレーキライト

FRE935NER

for pair



INDICATORI DI DIREZIONE A LED

LED TURN SIGNALS - INTERMITENTES A LED - BLINKER - LED ウィンカー

B52



Coppia frecce a led / Pair of led turn signals
 Juego de intermitentes en led / Paar Led Blinker / LED ウィンカー (ペア)

Material: ABS
 Homologated: E8

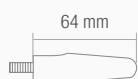

■ Indicators

FRE929NER

for pair

TheTube



Coppia frecce a led / Pair of led turn signals
 Juego de intermitentes en led / Paar Led Blinker / LED ウィンカー (ペア)

Material: Aluminum
 Homologated: E8



■ Indicators

● FRE930COB

● FRE930ROS

for pair

! END STOCK 廃盤



Coppia frecce a led / Pair of led turn signals
Juego de intermitentes en led / Paar Led Blinker / LED ウィンカー (ペア)

Material: ABS
 Homologated: E8

- Tecnologia innovativa MULTI-PIXEL
 Innovative MULTI-PIXEL technology
 Tecnologia innovadora MULTI PIXEL
 Innovative MULTI-PIXEL-Technologie
 マルチピクセルLED採用

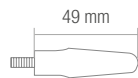

■ Indicators

FRE936NER

for pair



Coppia frecce a led / Pair of led turn signals
Juego de intermitentes en led / Paar Led Blinker / LED ウィンカー (ペア)

Material: ABS
 Homologated: E8



■ Indicators
 □ Front WHITE light

FRE937NER

for pair

! END STOCK 廃盤



Coppia frecce a led / Pair of led turn signals
Juego de intermitentes en led / Paar Led Blinker / LED ウィンカー (ペア)

Material: ABS
 Homologated: E8



■ Indicators
 ■ Rear RED Light - テールライト
 ■ Brake Light - ブレーキライト

FRE938NER

for pair

! END STOCK 廃盤



INDICATORI DI DIREZIONE A LED

LED TURN SIGNALS - INTERMITENTES A LED - BLINKER - LED ウィンカー



SEQUENTIAL LIGHT

Coppia frecce a led / Pair of led turn signals

Juego de intermitentes en led / Paar Led Blinker / LED ウィンカー (ペア)

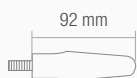
Material: ABS
Homologated: EB

92 mm



■ Indicators
■ Rear RED Light - テールライト
■ Brake Light - ブレーキライト

FRE923NER

for pair

! END STOCK 廃盤



SEQUENTIAL LIGHT

Coppia frecce a led / Pair of led turn signals

Juego de intermitentes en led / Paar Led Blinker / LED ウィンカー (ペア)

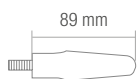
Material: ABS
Homologated: EB

89 mm



■ Indicators

FRE925NER

for pair

! END STOCK 廃盤



Coppia frecce a led / Pair of led turn signals
 Juego de intermitentes en led / Paar Led Blinker / LED ウィンカー (ペア)

Material: ABS
 Homologated: E8

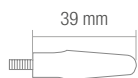

■ Indicators

FRE928NER

for pair

! END STOCK 廃盤



Coppia frecce a led / Pair of led turn signals
 Juego de intermitentes en led / Paar Led Blinker / LED ウィンカー (ペア)

Material: ABS
 Homologated: E8

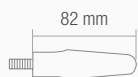

■ Indicators

FRE926NER

for pair

! END STOCK 廃盤



Coppia frecce a led / Pair of led turn signals
 Juego de intermitentes en led / Paar Led Blinker / LED ウィンカー (ペア)

Material: ABS
 Homologated

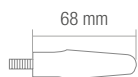

■ Indicators

FRE922NER

for pair

! END STOCK 廃盤

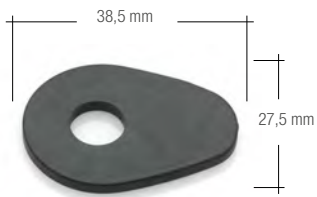

Piastrine frecce / Plates for direction indicators**Placas cubre intermitente / Adapter für Blinker / ウィンカー用プレート**

PFY

for 4 pieces

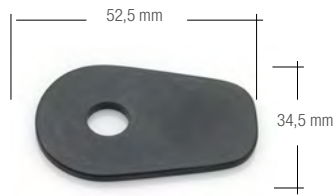

PFK

for 4 pieces



PFH2

for 4 pieces

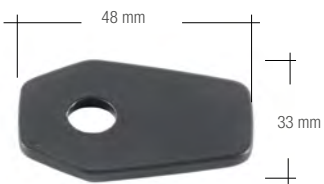

PFS

for 4 pieces



PFK2

for 4 pieces

Espositore per indicatori di direzione**Display for turn signals****Expositor para intermitentes****Aufsteller für Blinker****ウィンカー用ディスプレイスタンド**

x 8

NOT INCLUDED

EXP009



100% MADE IN ITALY
PATENTED DESIGN®
HOMOLOGATED

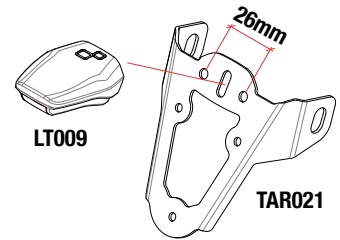

Luce targa Python
Python license plate light
Luz matricula Python
Python Kennzeichenbeleuchtung
パイソン ナンバー プレート ランプ

○ LT009BIA !END STOCK 廃盤

● LT009NER

NOT HOMOLOGATED



Faro posteriore "RAIN"
Rear light "RAIN"
Luz trasera "RAIN"
Rücklicht "RAIN"
レーシングリアライト(雨天時用)

LT011

HOMOLOGATED

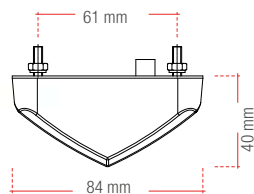

Faro posteriore con luce di posizione + STOP (no luce targa)
Rear light with license plate light + stop (without license plate light)
Luz trasera con luz de matricula + stop (sin luz de matricula)
Rücklicht mit kennzeichenleuchte + stop (ohne kennzeichenleuchte)
リアライト (ポジションライト + ブレーキランプ)

LT013



Kit resistenza
Resistor kit
Kit resistencia
Kit Widerstand
レジスター キット

FRE02

10W / 6 ohm



Kit resistenza
Resistor kit
Kit resistencia
Kit Widerstand
レジスター キット

FRE002

25W / 10 ohm



Kit resistenza
Resistor kit
Kit resistencia
Kit Widerstand
レジスター キット

FRE001

5W / 22 ohm



Kit resistenza
Resistor kit
Kit resistencia
Kit Widerstand
レジスター キット

FRE003

10w - 27 ohm



Kit resistenza
Resistor kit
Kit resistencia
Kit Widerstand
レジスター キット

FRE004

21w - 8 ohm



Kit resistenza
Resistor kit
Kit resistencia
Kit Widerstand
レジスター キット

FRE005

21 w - 10 ohm

**FIXEDINTERMITTENCE**

Relè elettronico
Electronic relé
Relè electrónico
Elektronisches Relais
ウィンカーリレー

FRE010

12v - 180w - 15A

**ADJUSTABLEINTERMITTENCE**

Relè elettronico
Electronic relé
Relè electrónico
Elektronisches Relais
ウィンカーリレー

FRE011

12v (0,6 -> 180w) - 0,05 - 15A
LED点滅速度が調節可能

**FIXEDINTERMITTENCE**

Kit resistenza
Resistor kit
Kit resistencia
Kit Widerstand
レジスター キット

FRE012

12,8v - (1-> 100w) - 10A

Specific for: **Honda****FIXEDINTERMITTENCE**

Relè elettronico
Electronic relé
Relè electrónico
Elektronisches Relais
ウィンカーリレー

FRE013

12,8v / 1 - 100w

Specific for:
Honda
Kawasaki
Yamaha**FIXEDINTERMITTENCE**

Relè elettronico
Electronic relé
Relè electrónico
Elektronisches Relais
ウィンカーリレー

FRE014

12v (0,6v -> 120w) - 0,05 - 10A

Specific for:
Suzuki Plug & Play**FIXEDINTERMITTENCE**

Kit resistenza
Resistor kit
Kit resistencia
Kit Widerstand
レジスター キット

FRE015

(12->13,8v) 1-> 100w



HONDA
Kit adattatori
Adapter kit
Kit adaptor
Adapter-kit
レジスター付きアダプター

FRE006



YAMAHA
Kit adattatori
Adapter kit
Kit adaptor
Adapter-kit
レジスター付きアダプター

FRE007



SUZUKI
Kit adattatori
Adapter kit
Kit adaptor
Adapter-kit
レジスター付きアダプター

FRE008



KAWASAKI
Kit adattatori
Adapter kit
Kit adaptor
Adapter-kit
レジスター付きアダプター

FRE009



BMW
Kit adattatori
Adapter kit
Kit adaptor
Adapter-kit
レジスター付きアダプター

FRE016



TRIUMPH
Kit adattatori
Adapter kit
Kit adaptor
Adapter-kit
レジスター付きアダプター

FRE017



HONDA
Kit adattatori
Adapter kit
Kit adaptor
Adapter-kit
レジスター付きアダプター

FRE018

With integrated resistors



HONDA
Kit adattatori
Adapter kit
Kit adaptor
Adapter-kit
レジスター付きアダプター

FRE019

With integrated resistors



HONDA
Kit adattatori
Adapter kit
Kit adaptor
Adapter-kit
レジスター付きアダプター

FRE020

With integrated resistors



SUZUKI & YAMAHA
Kit adattatori
Adapter kit
Kit adaptor
Adapter-kit
レジスター付きアダプター

FRE021



SUZUKI & YAMAHA
Kit adattatori
Adapter kit
Kit adaptor
Adapter-kit
レジスター付きアダプター

FRE022

With integrated resistors

BORN
TO BE
MOTO



Honda CB 750 Hornet



LEVE
LEVERS
MANETA
BREMS UND KUPPLUNGS HEBEL
レバー



ALUMINIUM 64 gr
vs NEW Technology Lightech 33 Gr



Aggiornamento del sistema di regolazione
Updating of the adjustment system
Actualización del sistema de ajuste
Aktualisierung des Einstellsystems
調整機構を更新

NEW
DESIGN



HARD COATING SURFACE TREATMENT

Maggiore reattività alla frenata
Greater responsiveness to braking
Mayor capacidad de respuesta en la frenada
Bessere Reaktionsfähigkeit beim Bremsen
ブレーキ時のタッチ感の向上



Ampliamento della gamma leve con l'introduzione di una **nuova geometria**
Expansion of the lever range with the introduction of a **new geometry**
Ampliación de la gama de manetas con la introducción de una **nueva geometría**
Erweiterung der Hebelpalette durch Einführung einer **neuen Geometrie**
新形状導入により、レバーの選択肢が拡大

Available colours: ●

Year	Code	Code	Price	Code	Price
------	------	------	-------	------	-------



APRILIA

NEW	RS 660 / Tuono 660	20	24	KLEV131H	KLEV131J		KLEV131K	
NEW	RSV1000	04	09	KLEV137H	KLEV137J		KLEV137K	
NEW	RSV4 R / RR / RF / Factory / APRC	09	20	KLEV131H	KLEV131J		KLEV131K	
NEW	RSV4 1100 Factory	19	24	KLEV131H	KLEV131J		KLEV131K	
NEW	Tuono V4 RR / 1100 Factory	17	24	KLEV131H	KLEV131J		KLEV131K	

BMW

NEW	S1000 R	14	20	KLEV139H	KLEV139J		KLEV139K	
NEW	S1000 R	21	24	KLEV134H	KLEV134J		KLEV134K	
NEW	S1000 RR	09	14	KLEV140H	KLEV140J		KLEV140K	
NEW	S1000 RR	15	18	KLEV139H	KLEV139J		KLEV139K	
NEW	S1000 RR	19	24	KLEV141H	KLEV141J		KLEV141K	

DUCATI

NEW	749 - 999	02	06	KLEV137H	KLEV137J		KLEV137K	
NEW	848 - 1098 - 1198	07	11	KLEV137H	KLEV137J		KLEV137K	
NEW	Diavel	11	18	KLEV137H	KLEV137J		KLEV137K	
NEW	Monster 937	21	22	KLEV137H	KLEV137J		KLEV137K	
NEW	Monster 1100	10	13	KLEV137H	KLEV137J		KLEV137K	
NEW	Monster 1200 S / R	14	20	KLEV137H	KLEV137J		KLEV137K	
NEW	Panigale 899	12	16	KLEV137H	KLEV137J		KLEV137K	
NEW	Panigale 959	16	21	KLEV137H	KLEV137J		KLEV137K	
NEW	Panigale 1199	12	16	KLEV137H	KLEV137J		KLEV137K	
NEW	Panigale 1299	15	17	KLEV137H	KLEV137J		KLEV137K	
NEW	Panigale V2	20	24	KLEV137H	KLEV137J		KLEV137K	
NEW	Panigale V4 / S / R	18	24	KLEV137H	KLEV137J		KLEV137K	
NEW	Streetfighter 848 / 1100	09	16	KLEV137H	KLEV137J		KLEV137K	
NEW	Streetfighter V2 / S	21	24	KLEV137H	KLEV137J		KLEV137K	
NEW	Streetfighter V4 / S	20	24	KLEV137H	KLEV137J		KLEV137K	

HONDA

	CB 750 Hornet	23	24	KLEV135H	KLEV135J		KLEV135K	
	CB 1000 R	08	17	KLEV110H	KLEV110J		KLEV110K	
	CB 1000 R	18	20	KLEV109H	KLEV109J		KLEV109K	
	CBR 600 RR	07	17	KLEV109H	KLEV109J		KLEV109K	
	CBR 1000 RR	04	07	KLEV110H	KLEV110J		KLEV110K	
	CBR 1000 RR	08	19	KLEV109H	KLEV109J		KLEV109K	
	CBR 1000 RR - R	20	23	KLEV109H	KLEV109J		KLEV109K	
NEW	CBR 1000 RR - R SP	20	23	KLEV138H	KLEV138J		KLEV138K	

KAWASAKI

NEW	Ninja 250	08	13	KLEV127H	KLEV127J		KLEV127K	
NEW	Ninja 300	14	17	KLEV127H	KLEV127J		KLEV127K	
NEW	Ninja 400	18	23	KLEV127H	KLEV127J		KLEV127K	
NEW	Z400	18	23	KLEV127H	KLEV127J		KLEV127K	
NEW	Z650	17	22	KLEV142H	KLEV142J		KLEV142K	
	Z750	07	12	KLEV143H	KLEV143J		KLEV143K	
	Z800	13	16	KLEV143H	KLEV143J		KLEV143K	
NEW	Z900	17	24	KLEV142H	KLEV142J		KLEV142K	
	Z900 SE	22	24	KLEV119H	KLEV119J		KLEV119K	

KIT LEVA • FRENO & FRIZIONE

LEVER KIT • BRAKE & CLUTCH / KIT MANETA • FRENO & EMBRAGUE / KIT KLAPPBARE • BREMS UND KUPPLUNGSHABEL / レバーキット・ブレーキ&クラッチ

Year	Code	Code	Price	Code	Price
------	------	------	-------	------	-------



KAWASAKI					
Z1000	17	20	KLEV119H	KLEV119J	KLEV119K
Z1000 SX	17	20	KLEV119H	KLEV119J	KLEV119K
NEW ZX 4 RR	24	24	KLEV142H	KLEV142J	KLEV142K
ZX6R / ZX636	05	18	KLEV105H	KLEV105J	KLEV105K
ZX636	19	21	KLEV119H	KLEV119J	KLEV119K
ZX10R	06	15	KLEV105H	KLEV105J	KLEV105K
ZX10R	16	20	KLEV108H	KLEV108J	KLEV108K
ZX10R	21	24	KLEV125H	KLEV125J	KLEV125K

KTM					
NEW Duke 790	18	24	KLEV130H	KLEV130J	KLEV130K
NEW Duke 890 GP	20	23	KLEV130H	KLEV130J	KLEV130K

MV					
F3 675	12	20	KLEV114H	KLEV114J	KLEV114K
F3 800	13	20	KLEV114H	KLEV114J	KLEV114K

SUZUKI					
GSXR 600 / 750	06	17	KLEV113H	KLEV113J	KLEV113K
GSXR 1000	05	06	KLEV113H	KLEV113J	KLEV113K
GSXR 1000	09	16	KLEV113H	KLEV113J	KLEV113K
GSXR 1000 / R	17	22	KLEV113H	KLEV113J	KLEV113K
GXSX 1000	15	21	KLEV113H	KLEV113J	KLEV113K

TRIUMPH					
NEW Daytona 675 R	11	16	KLEV133H	KLEV133J	KLEV133K
NEW Street Triple 765 RS	18	24	KLEV133H	KLEV133J	KLEV133K
NEW Speed Triple 1050 / 1050 R	11	16	KLEV133H	KLEV133J	KLEV133K

YAMAHA					
NEW FZ6 / Fazer	04	12	KLEV128H	KLEV128J	KLEV128K
NEW FZ8	10	16	KLEV128H	KLEV128J	KLEV128K
NEW FZ1 / Fazer	06	16	KLEV128H	KLEV128J	KLEV128K
NEW MT-07 / MT-07 Tracer	14	23	KLEV128H	KLEV128J	KLEV128K
NEW Tracer 7 / Tracer 7 GT	20	24	KLEV128H	KLEV128J	KLEV128K
NEW MT-09 / MT-09 SP	13	20	KLEV128H	KLEV128J	KLEV128K
NEW MT-09 / MT09 SP / Tracer 9 / Tracer 9 GT	21	24	KLEV136H	KLEV136J	KLEV136K
NEW MT-10	16	21	KLEV128H	KLEV128J	KLEV128K
NEW MT-10	22	23	KLEV124H	KLEV124J	KLEV124K
NEW R1	04	14	KLEV107H	KLEV107J	KLEV107K
NEW R1 / R1-M	15	24	KLEV136H	KLEV136J	KLEV136K
NEW R3	15	24	KLEV126H	KLEV126J	KLEV126K
NEW R6	05	16	KLEV107H	KLEV107J	KLEV107K
NEW R6	17	23	KLEV136H	KLEV136J	KLEV136K
NEW R7	22	24	KLEV124H	KLEV124J	KLEV124K
NEW T-Max 500 - 530 - 560	08	24	KLEV129H	KLEV129J	KLEV129K
NEW XSR 700	15	20	KLEV128H	KLEV128J	KLEV128K
NEW XSR 900	13	20	KLEV128H	KLEV128J	KLEV128K



Available colours: ●

Year	Code	Code	Price	Code	Price
------	------	------	-------	------	-------



	Year	Year	Code	Code	Price	Code	Price
BREMBO							
NEW	BREMBO (16 x 18) (19 x 18) *	-	-	LEVD502H	LEVD502J	LEVD502K	
NEW	BREMBO (19 x 20) *	-	-	LEVD504H	LEVD504J	LEVD504K	
APRILIA							
NEW	RS 660	20	24	LEVD143H	LEVD143J	LEVD143K	
NEW	RSV1000	04	09	LEVD143H	LEVD143J	LEVD143K	
NEW	RSV4 R / RR / RF / Factory / APRC	09	20	LEVD143H	LEVD143J	LEVD143K	
NEW	RSV4 1100 Factory	19	24	LEVD143H	LEVD143J	LEVD143K	
NEW	Tuono V4 RR / 1100 Factory	17	24	LEVD143H	LEVD143J	LEVD143K	
BMW							
NEW	S1000 R	14	20	LEVD147H	LEVD147J	LEVD147K	
NEW	S1000 R	21	24	LEVD144H	LEVD144J	LEVD144K	
NEW	S1000 RR	09	24	LEVD147H	LEVD147J	LEVD147K	
DUCATI							
NEW	749 - 999	02	06	LEVD143H	LEVD143J	LEVD143K	
NEW	848 - 1098 - 1198	07	11	LEVD143H	LEVD143J	LEVD143K	
NEW	Diavel	11	18	LEVD143H	LEVD143J	LEVD143K	
NEW	Monster 937	21	24	LEVD143H	LEVD143J	LEVD143K	
NEW	Monster 1100	10	13	LEVD143H	LEVD143J	LEVD143K	
NEW	Monster 1200 / R	14	20	LEVD143H	LEVD143J	LEVD143K	
NEW	Panigale 899	12	16	LEVD143H	LEVD143J	LEVD143K	
NEW	Panigale 959	16	21	LEVD143H	LEVD143J	LEVD143K	
NEW	Panigale 1199	12	16	LEVD143H	LEVD143J	LEVD143K	
NEW	Panigale 1299	15	17	LEVD143H	LEVD143J	LEVD143K	
NEW	Panigale V2	20	24	LEVD143H	LEVD143J	LEVD143K	
NEW	Panigale V4 / S / R	18	24	LEVD143H	LEVD143J	LEVD143K	
NEW	Streetfighter 848 / 1100	09	16	LEVD143H	LEVD143J	LEVD143K	
NEW	Streetfighter V2	21	24	LEVD143H	LEVD143J	LEVD143K	
NEW	Streetfighter V4 / S	20	24	LEVD143H	LEVD143J	LEVD143K	

* LEV502





* LEV504



ONLY FOR BREMBO MODELS

Per il montaggio sono necessari i componenti originali della leva Brembo
 For the fitment, OEM Brembo components required
 Para el montaje es necesario los componentes originales de la maneta Brembo
 Für die Montage sind die originale Brembo Hebelteile notwendig.
 本製品装着時には、BREMBOの各純正部品のご使用が必須となります

	Year	Code	Code	Price	Code	Price
			 H		 J	 K
HONDA						
NEW	CB 750 Hornet	23	24	LEVD145H	LEVD145J	LEVD145K
	CB 1000 R	08	20	LEVD128H	LEVD128J	LEVD128K
	CBR 600 RR	07	17	LEVD128H	LEVD128J	LEVD128K
	CBR 1000 RR	04	19	LEVD128H	LEVD128J	LEVD128K
	CBR 1000 RR-R	20	23	LEVD128H	LEVD128J	LEVD128K
NEW	CBR 1000 RR-R SP	20	23	LEVD143H	LEVD143J	LEVD143K
KAWASAKI						
	Ninja 250	08	13	LEVD139H	LEVD139J	LEVD139K
	Ninja 300	14	17	LEVD139H	LEVD139J	LEVD139K
	Ninja 400	18	23	LEVD139H	LEVD139J	LEVD139K
	Z 400	18	23	LEVD139H	LEVD139J	LEVD139K
NEW	Z 650	17	22	LEVD148H	LEVD148J	LEVD148K
NEW	Z750	07	12	LEVD148H	LEVD148J	LEVD148K
NEW	Z 800	13	16	LEVD148H	LEVD148J	LEVD148K
NEW	Z 900	17	24	LEVD148H	LEVD148J	LEVD148K
	Z 900 SE	21	24	LEVD124H	LEVD124J	LEVD124K
	Z1000 / SX	17	20	LEVD124H	LEVD124J	LEVD124K
NEW	ZX 4 RR	24	24	LEVD148H	LEVD148J	LEVD148K
	ZX6R / ZX 636	05	21	LEVD124H	LEVD124J	LEVD124K
	ZX10R	06	15	LEVD124H	LEVD124J	LEVD124K
	ZX10R	16	20	LEVD127H	LEVD127J	LEVD127K
	ZX10R	21	24	LEVD137H	LEVD137J	LEVD137K
KTM						
	Duke 790	18	23	LEVD132H	LEVD132J	LEVD132K
	Duke 890 GP	20	23	LEVD132H	LEVD132J	LEVD132K
MV						
	F3 675	12	20	LEVD123H	LEVD123J	LEVD123K
	F3 800	13	20	LEVD123H	LEVD123J	LEVD123K
SUZUKI						
	GSXR 600 / 750	04	17	LEVD123H	LEVD123J	LEVD123K
	GSXR 1000	05	22	LEVD123H	LEVD123J	LEVD123K
	GSXS 1000	15	21	LEVD123H	LEVD123J	LEVD123K
TRIUMPH						
NEW	Daytona 675 R	09	16	LEVD143H	LEVD143J	LEVD143K
NEW	Street Triple 765 RS	18	23	LEVD143H	LEVD143J	LEVD143K
NEW	Speed Triple 1050 S / 1050 R	11	16	LEVD143H	LEVD143J	LEVD143K
YAMAHA						
	FZ6 / Fazer	04	16	LEVD140H	LEVD140J	LEVD140K
	FZ1 / Fazer	06	16	LEVD140H	LEVD140J	LEVD140K
	FZ8	10	16	LEVD140H	LEVD140J	LEVD140K
	MT-07	14	20	LEVD140H	LEVD140J	LEVD140K
	MT-09	13	20	LEVD140H	LEVD140J	LEVD140K
NEW	MT-09 / MT09 SP / Tracer 9 / Tracer 9 GT	21	24	LEVD146H	LEVD146J	LEVD146K
	MT-10	16	21	LEVD140H	LEVD140J	LEVD140K
	R1	04	14	LEVD122H	LEVD122J	LEVD122K
NEW	R1 / R1-M	15	24	LEVD146H	LEVD146J	LEVD146K
	R3	15	23	LEVD138H	LEVD138J	LEVD138K
	R6	05	16	LEVD122H	LEVD122J	LEVD122K
NEW	R6	17	23	LEVD146H	LEVD146J	LEVD146K
	R7	22	24	LEVD136H	LEVD136J	LEVD136K
	T-Max 500 - 530 - 560 (RIGHT)	08	24	LEVD141H	LEVD141J	LEVD141K
	T-Max 500 - 530 - 560 (LEFT)	08	24	LEVD142H	LEVD142J	LEVD142K
	XJ6	09	16	LEVD140H	LEVD140J	LEVD140K
	XSR 700	15	20	LEVD140H	LEVD140J	LEVD140K
	XSR 900	13	20	LEVD140H	LEVD140J	LEVD140K



Available colours: ●

Year	Code	Code	Price	Code	Price
------	------	------	-------	------	-------



APRILIA					
RS 660	20	24	LEVXF001H	LEVXF001J	LEVXF001K
RSV1000	04	09	LEVXF107H	LEVXF107J	LEVXF107K
RSV4 R / RR / RF / Factory / APRC	09	20	LEVXF001H	LEVXF001J	LEVXF001K
RSV4 1100 Factory	19	23	LEVXF001H	LEVXF001J	LEVXF001K
TUONO V4 / RR / Factory	11	23	LEVXF001H	LEVXF001J	LEVXF001K

BMW					
S1000 R	14	20	LEVXF015H	LEVXF015J	LEVXF015K
NEW S1000 R	21	24	LEVXF113H	LEVXF113J	LEVXF113K
S1000 RR	09	14	LEVXF008H	LEVXF008J	LEVXF008K
S1000 RR	15	18	LEVXF015H	LEVXF015J	LEVXF015K
NEW S1000 RR	19	24	LEVXF115H	LEVXF115J	LEVXF115K

DUCATI					
NEW 749 - 999	02	06	LEVXF114H	LEVXF114J	LEVXF114K
848 - 1098 - 1198	07	11	LEVXF114H	LEVXF114J	LEVXF114K
Diavel	11	16	LEVXF114H	LEVXF114J	LEVXF114K
Monster S4R	07	07	LEVXF114H	LEVXF114J	LEVXF114K
Monster 937	21	22	LEVXF114H	LEVXF114J	LEVXF114K
Monster 1100	10	13	LEVXF114H	LEVXF114J	LEVXF114K
Monster 1200 / R	14	20	LEVXF114H	LEVXF114J	LEVXF114K
Panigale 899	12	16	LEVXF114H	LEVXF114J	LEVXF114K
Panigale 959	16	21	LEVXF114H	LEVXF114J	LEVXF114K
Panigale 1199	12	16	LEVXF114H	LEVXF114J	LEVXF114K
Panigale 1299	15	17	LEVXF114H	LEVXF114J	LEVXF114K
Panigale V4 / S / R	18	23	LEVXF114H	LEVXF114J	LEVXF114K
Panigale V2	20	23	LEVXF114H	LEVXF114J	LEVXF114K
Streetfighter 848 / 1100	09	16	LEVXF114H	LEVXF114J	LEVXF114K
Streetfighter V2	22	23	LEVXF114H	LEVXF114J	LEVXF114K
Streetfighter V4 / S	20	23	LEVXF114H	LEVXF114J	LEVXF114K

HONDA					
CB 750 Hornet	23	24	LEVXF002H	LEVXF002J	LEVXF002K
CB 1000 R	08	17	LEVXF003H	LEVXF003J	LEVXF003K
CB 1000 R	18	20	LEVXF002H	LEVXF002J	LEVXF002K
CBR 600 RR	03	17	LEVXF002H	LEVXF002J	LEVXF002K
CBR 1000 RR	04	07	LEVXF003H	LEVXF003J	LEVXF003K
CBR 1000 RR	08	19	LEVXF002H	LEVXF002J	LEVXF002K
CBR 1000 RR-R	20	23	LEVXF002H	LEVXF002J	LEVXF002K
CBR 1000 RR-R / SP	20	23	LEVXF002H	LEVXF002J	LEVXF002K

Year	Code	Code	Price	Code	Price
------	------	------	-------	------	-------



KAWASAKI					
Ninja 250	08	13	LEVXF019H	LEVXF019J	LEVXF019K
Ninja 300	14	17	LEVXF019H	LEVXF019J	LEVXF019K
Ninja 400	18	23	LEVXF019H	LEVXF019J	LEVXF019K
Z400	18	24	LEVXF019H	LEVXF019J	LEVXF019K
Z650	17	22	LEVXF005H	LEVXF005J	LEVXF005K
Z750	07	12	LEVXF004H	LEVXF004J	LEVXF004K
Z800	13	16	LEVXF004H	LEVXF004J	LEVXF004K
Z900 / Z900 SE	17	24	LEVXF005H	LEVXF005J	LEVXF005K
Z1000	07	16	LEVXF004H	LEVXF004J	LEVXF004K
Z1000	17	20	LEVXF005H	LEVXF005J	LEVXF005K
Z1000 SX	11	16	LEVXF004H	LEVXF004J	LEVXF004K
Z1000 SX	17	20	LEVXF005H	LEVXF005J	LEVXF005K
ZX 4 RR	24	24	LEVXF005H	LEVXF005J	LEVXF005K
ZX6R - 636	05	18	LEVXF004H	LEVXF004J	LEVXF004K
ZX636	19	21	LEVXF005H	LEVXF005J	LEVXF005K
ZX10R	06	24	LEVXF004H	LEVXF004J	LEVXF004K

KTM					
Duke 790	18	24	LEVXF112H	LEVXF112J	LEVXF112K
Duke 890 R	20	24	LEVXF112H	LEVXF112J	LEVXF112K

MV					
F3 675	12	20	LEVXF012H	LEVXF012J	LEVXF012K
F3 800	13	20	LEVXF012H	LEVXF012J	LEVXF012K

SUZUKI					
GSXR 600 / 750	06	17	LEVXF001H	LEVXF001J	LEVXF001K
GSXR 1000	05	06	LEVXF001H	LEVXF001J	LEVXF001K
GSXR 1000	09	22	LEVXF001H	LEVXF001J	LEVXF001K
GSXS 1000	15	21	LEVXF001H	LEVXF001J	LEVXF001K

TRIUMPH					
Daytona 675	06	14	LEVXF018H	LEVXF018J	LEVXF018K
Daytona 675R	11	16	LEVXF018H	LEVXF018J	LEVXF018K
Street Triple 675 R	08	17	LEVXF018H	LEVXF018J	LEVXF018K
Street Triple 765 R / RS	13	24	LEVXF018H	LEVXF018J	LEVXF018K
Speed Triple 1050 S / 1050R	11	16	LEVXF018H	LEVXF018J	LEVXF018K

YAMAHA					
FZ6 / Fazer	04	16	LEVXF001H	LEVXF001J	LEVXF001K
FZ8	10	16	LEVXF001H	LEVXF001J	LEVXF001K
FZ1 / Fazer	06	16	LEVXF001H	LEVXF001J	LEVXF001K
MT-07	14	20	LEVXF001H	LEVXF001J	LEVXF001K
MT-09 / MT-09 SP / Tracer 9 / Tracer 9 GT	13	24	LEVXF001H	LEVXF001J	LEVXF001K
MT-10	16	21	LEVXF001H	LEVXF001J	LEVXF001K
R1 / R1-M	00	24	LEVXF001H	LEVXF001J	LEVXF001K
R3	15	24	LEVXF021H	LEVXF021J	LEVXF021K
R6	00	23	LEVXF001H	LEVXF001J	LEVXF001K
R7	22	24	LEVXF001H	LEVXF001J	LEVXF001K
XJ6	09	16	LEVXF001H	LEVXF001J	LEVXF001K
XSR 700	15	20	LEVXF001H	LEVXF001J	LEVXF001K
XSR 900	13	20	LEVXF001H	LEVXF001J	LEVXF001K





Nuova leva frizione regolabile con leva reclinabile
 New folding **adjustable** clutch lever
 Nueva maneta de embrague **reclinable ajustable**
 Neuer **einstellbarer klappbarer** Kupplungshebel
 新たなアジャスタブル可倒式クラッチレバー

**NEW
DESIGN**



Il pilota può gestire lo stacco della frizione, **perfezionare le partenze** e personalizzare la corsa della leva
 The rider can manage the clutch release, **perfect the starts** and personalize the lever stroke
 El conductor puede manejar la liberación del embrague, **perfeccionar los arranques** y personalizar la carrera de la maneta
 Der Fahrer kann die Kupplungsfreigabe verwalten, was bedeutet, dass der Fahrer **die Starts perfektionieren** und den Hebelhub anpassen kann
 レバー比のカスタマイズにより、ライダーはクラッチリリースのタイミングを管理することができ、完璧なスタートを切ることができます

FOR RACING USE ONLY



Code	Price	Code	Price	Code	Price
		H		J	
					
					
Available colours: ●					
LEVXF200 H		LEVXF200 J		LEVXF200 K	



Il sistema di chiusura del bracciale è **ancora più veloce**, grazie alla fascetta di chiusura con il sistema a cerniera
 The closing system of the joint is **even faster** thanks to the closing strap with the hinge system
 el sistema de cierre de la junta es **aún más rápido** gracias a la correa de cierre con el sistema de bisagra
 Das Schließsystem des Gelenks ist dank des Schließbandes mit dem Scharniersystem **noch schneller**
 付属の部品を付け替えることで素早く簡単にレバー比を変更することができます(30 / 32 / 34mm)

Interassi da **30/32/34 mm**
 Wheelbases from **30/32/34 mm**
 Distancia entre ejes de **30/32/34 mm**
 Radstände von **30/32/34 mm**
 できます(**30 / 32 / 34mm**)

FOR RACING USE ONLY

Code	Price	Code	Price	Code	Price
		H		J	
					
					
Available colours: ●					
Leva frizione a cavo completa di bracciale ad interasse variabile Cable clutch lever with variable wheelbase Maneta de embrague de cable con distancia entre ejes variable Kabelkupplungshebel mit variablem Radstand レバー比調節機能付きワイヤー式クラッチレバー		LEVXF100 H		LEVXF100 J	
				LEVXF100 K	

RICAMBI LEVE

LEVER SPARE PARTS - RECAMBIOS DE MANETAS - ERSATZTEILE FÜR BREMS UND KUPPLUNGHEBEL - レバー スペア パーツ



Leva in alluminio
Aluminum lever
Maneta en aluminio
Aluminiumhebel
用アルミニウムレバー

RLEV003J

Available colours: ● ● ● ● ●



ALIEN
GRIP

Leva in magnesio
Magnesium lever
Maneta en magnesio
Hebel aus magnesium
マグネシウムレバー

RLEV001H

RLEV001J

RLEV001K

Available colours: ●



Leva in alluminio **Brembo**
Brembo aluminum levers
Maneta de aluminio **Brembo**
Brembo-Aluminiumhebel
Brembo用アルミニウムレバー

RLEV001B - RLEV002B

€ 60,00

Available colours: ●



ALIEN
GRIP

Kit inserti in gomma per leva "Alien"
Rubber inserts kit for "Alien" lever
Kit para la maneta "Alien"
Gummeinsätze für Hebel "Alien"
ALIEN レバー用 ラバー インサート キット

			one strip
●	GM001ROS		
●	GM001VER		
●	GM001BLU		
●	GM001NER		
○	GM001BIA		
●	GM001ARA		
●	GM001GRI		



Cavi di regolazione
Cables for remote adjuster
Cable regulacion
Ersatzkabel
リモート アジャスター用 ケーブル

A	for Brembo RCS 19 / Brembo Corsa Corta	RLEV014	
B	for Brembo Racing 19x18 - 16x18	RLEV009	
C	for Lighttech model	RLEV020	



Registro leva freno con supporto
Remote brake adjuster with mounting clamp
Regulador para maneta de freno y soporte
Ersatzteil für Links Verstellung ohne Kabel
リモート ブレーキ アジャスター クランプ 付属

RLEV015





PROTEZIONI LEVE
LEVERS GUARDS
PROTECCIÓN DE MANETA
HEBELPROTEKTOR
レバープロテクター



PROTEZIONI LEVE

LEVERS GUARDS - PROTECCIÓN DE MANETA - HEBELPROTEKTOR - レバー プロテクター



Protezioni leve GC-Tech (corpo + terminale, escluso adattatore)
 GC-Tech lever guards kit (body + guard end, adaptor not included)
 Protección manetas en GC-Tech (cuerpo + terminal, sin adaptador)
 GC-Tech Hebelprotektor (Hebel + Endstück, ohne Adapter)
 GC-Tech レバープロテクトキット レバープロテクト本体+プロテクトエンド (アダプターは別売)

	A	Code	Price
			for piece
Protezione leva freno Brake lever guard Protección maneta de freno Bremshebelprotektor アルミニウム ブレーキレバー プロテクター	R	135 mm	ISS200RT (body+guard end)
Protezione leva frizione Clutch lever guard Protección maneta de embrague Kupplungshebelprotektor アルミニウム クラッチレバー プロテクター	L	135 mm	ISS201LT (body+guard end)



Protezioni leve in alluminio **(corpo + terminale, escluso adattatore)**
 Aluminium lever guards kit **(body + guard end, adaptor not included)**
 Protección manetas en aluminio **(cuerpo + terminal, sin adaptador)**
 Hebelprotector aus Aluminium **(Hebel + Endstück, ohne Adapter)**
 アルミニウム レバー プロテクター キット . レバーガード本体 + ガードエンド (アダプターは別売)



					Price
					for piece
Protezione leva freno Brake lever guard Protección maneta de freno Bremshebelprotector アルミニウム ブレーキレバー プロテクター	R	132 mm	ISS113RA	(body+guard end)	
Protezione leva freno Brake lever guard Protección maneta de freno Bremshebelprotector アルミニウム ブレーキレバー プロテクター	R	148 mm	ISS120RA	(body+guard end)	
Protezione leva frizione Clutch lever guard Protección maneta de embrague Kupplungshebelprotector アルミニウム クラッチレバー プロテクター	L	132 mm	ISS119LA	(body+guard end)	
Protezione leva frizione Clutch lever guard Protección maneta de embrague Kupplungshebelprotector アルミニウム クラッチレバー プロテクター	L	148 mm	ISS114LA	(body+guard end)	

Protezioni leve in carbonio **(corpo + terminale, escluso adattatore)**
 Carbon lever guards kit **(body + guard end, adaptor not included)**
 Protección manetas en carbonio **(cuerpo + terminal, sin adaptador)**
 Hebelprotector aus Carbon **(Hebel + Endstück, ohne Adapter)**
 C-TECH カーボン レバープロテクター . レバーガード本体 + ガードエンド (アダプターは別売)



					Price
					for piece
Protezione leva freno Brake lever guard Protección maneta de freno Bremshebelprotector C-TECH カーボン ブレーキレバー プロテクター	R	132 mm	ISS115RC	(body+guard end)	
Protezione leva frizione Clutch lever guard Protección maneta de embrague Kupplungshebelprotector C-TECH カーボン クラッチレバー プロテクター	L	132 mm	ISS116LC	(body+guard end)	

RICAMBI PER PROTEZIONI LEVA

SPARE PARTS FOR LEVERS GUARD - REPUESTOS PARA PROTECCION DE MANETA - ERSATZTEILE FÜR HEBELPROTEKTOR - レバーガード用オプション

 100% Made in Italy

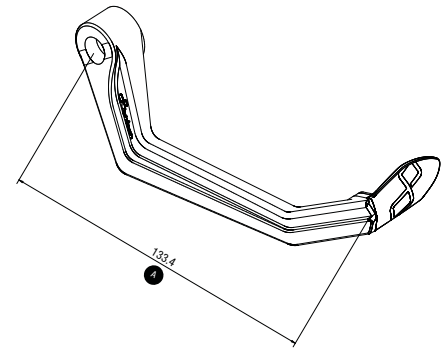
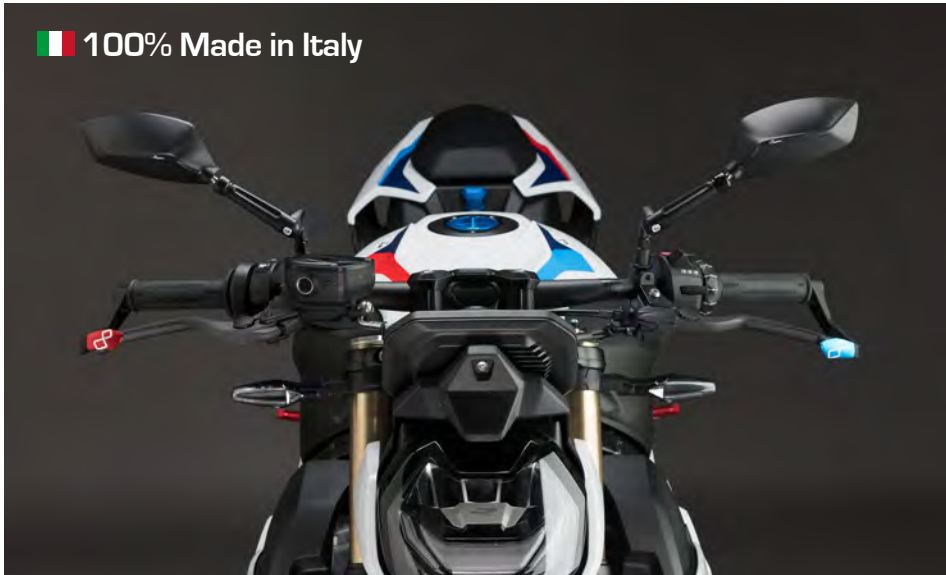

A

Verifica sempre la misura
Always check the measurement
Compruebe siempre la medida
Überprüfen Sie immer die Messung
必ずサイズの確認をしてください



Attenzione! Ricorda che l'adattatore è assolutamente necessario per poter applicare la protezione leva.

WARNING! The adaptor is absolutely necessary to install the lever protection.

¡ADVERTENCIA! El adaptador es absolutamente necesario para aplicar la proteccion de la maneta.

ACHTUNG! Der Adapter ist absolut notwendig, um die Hebelprotektor einzubauen.

注意! レバープロテクションの使用には必ず専用のアダプターが必要です



Body

+



Guard end



 Adaptors kit for lever guards
(check page 127)

Ricambi per protezioni leva - Spare parts for levers guard

Repuestos para proteccion de maneta - Ersatzteile für Hebelprotektor - レバーガード用オプション



green



gold



red



black



silver



cobalt



orange

Terminale R - Guard end R - Terminal R - Endstück R - ガードエンド - R

ISS117

for piece

Terminale L - Guard end L - Terminal L - Endstück L - ガードエンド - L

ISS118

for piece

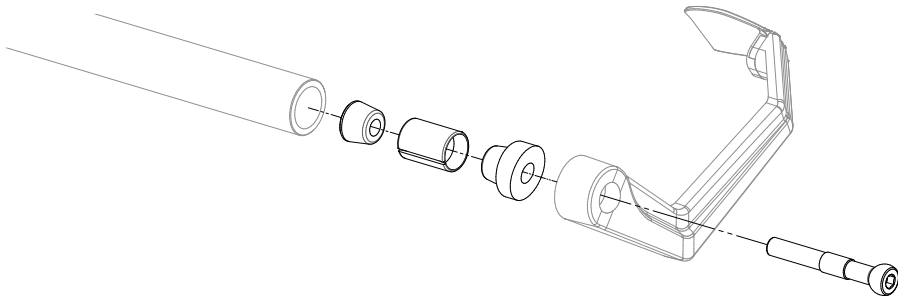
**WARNING!**

The adaptor is absolutely necessary in order to apply the lever guard.

		Year		Ø	Code	Price
						for piece
Universal adaptors				12/13,5	KPL301	
Universal adaptors				14/15,5	KPL329	
Universal adaptors (HBT006 - HBT009)				15,6/16,5	KPL332	
Universal adaptors (HBT004)				16/17,5	KPL302	
Universal adaptors				18/19,5	KPL319	
Universal adaptors				18,5/20	KPL321	
APRILIA						
RS 660		20	24		KPL331	
RSV4 (all versions)		09	24		KPL303	
RSV1000		04	08		KPL313	
Shiver 750		07	15		KPL313	
Tuono		06	09		KPL313	
Tuono V4 / 1100 Factory		11	24		KPL313	
BMW						
R Nine-T Scrambler / Pure / Urban / Racer		16	16		KPL325	
S1000 R		14	20		KPL325	
S1000 R		21	24		KPL334	
S1000 RR		09	18		KPL325	
S1000 RR		19	24		KPL330	
DUCATI						
1098 / 1198		07	11	16/17,5	KPL302	
Monster S4 - ST2		07	07		KPL304	
Monster 821		14	16	16/17,5	KPL302	
Monster 937		21	24	16/17,5	KPL302	
Monster 1100		11	13	14,5	KPL322	
Panigale 899 / 1199 / 1299		12	17		KPL318	
Panigale 959		16	20		KPL318	
Panigale V2 955		20	24		KPL318	
Panigale V4 / S / R		18	24	18	KPL319	
Streetfighter 848 / 1100		08	16	14,5	KPL322	
Streetfighter V2		22	24	13	KPL301	
Streetfighter V4		20	22	14,5	KPL322	
HONDA						
all			KPL306	
CB Hornet 750					KPL329	
KAWASAKI						
ER-6N		12	15		KPL304	
Ninja 250 / Ninja 400		17	23		KPL304	
Z400		17	23		KPL304	
Z750		04	12		KPL304	
Z650		17	20		KPL319	
Z800		13	16		KPL304	
Z900		17	23		KPL304	
Z1000		03	16		KPL304	

ADATTATORI PROTEZIONI LEVE

ADAPTORS KITS FOR LEVER GUARDS - ADAPTADORES PROTECCIONES MANETAS - ADAPTER FÜR HEBELPROTEKTOR - レバー プロテクター用アダプター キット

	Year	Ø	Code	Price
for piece				
KAWASAKI				
Z1000 SX	11	16	KPL304	
ZX250 R	09	12	KPL304	
ZX4 RR	24	24	KPL304	
ZX6R / 636	03	21	KPL304	
ZX10R	11	23	KPL304	
KTM				
Duke 125 / 390	17	23	KPL311	
Duke 790	18	24	KPL329	
Duke 890 R	20	23	KPL329	
Duke 990	24	24		
Duke 1290 R	20	23	KPL329	
Duke 1390 R	24	24		
MV				
Brutale 4 cilindri (all versions)	10	17	16/17,5	KPL302
B3 675 / 800	12	17		KPL320
F3 675 / 800	11	17	18/19,5	KPL319
F4 (all versions)	10	17	18/19,5	KPL323
SUZUKI				
Gladius 650	09	15		KPL309
GSR 600	06	11		KPL305
GSR 750	11	16		KPL305
GSXR 600 / 750	00	05		KPL305
GSXR 600 / 750	06	17		KPL309
GSXR 1000	03	04		KPL305
GSXR 1000	05	16		KPL309
GSXR 1000	17	23		KPL327
GSXS 750	17	20		KPL328
GSXS 8 R	23	23	M12/1,25	KPL335
GSXS 8 S	23	23	M12/1,25	KPL335
GSXS 1000	15	21		KPL302
TRIUMPH				
Street Triple 675 R	07	12		KPL302
Street Triple 675 R	13	16		KPL311
Street Triple 765 R / S	17	22		KPL311
YAMAHA				
Fazer 600 - FZ6	04	06		KPL310
Fazer 1000	01	12		KPL310
MT-07	14	23		KPL310
MT-09	13	20		KPL310
MT-09	21	22		KPL311
MT-10	16	21		KPL310
R 125	08	17		KPL310
R1 / R1M	98	24		KPL311
R3	15	22		KPL311
R6	06	23		KPL311
R7	22	24		KPL311
T Max 500 - 530 - 560	02	21		KPL310
T Max 560	22	23		KPL333
X-Max 400	13	19		KPL310





Team SpeedUp
Fermin Aldeguer and Alonso López



BRACCIALI MUNUBRIO E PIASTRE DI STERZO
CLIP-ONS AND TRIPLE CLAMP
SOPORTES MANILLAR Y PLACA TIJA SUPERIOR
LENKERSCHELLEN UND PLATTE FÜR LENKUNG
セパレートハンドル - トップブリッジ

PIASTRE DI STERZO

TRIPLE CLAMP - PLACA TIJA SUPERIOR - PLATTE FÜR LENKUNG - トップブリッジ



TCAAP002NER



TCAAP003NER - TCAAP004NER

		Year		Offset	Code	Price
APRILIA						
NEW	RS660	21	23		TCAAP002NER	
NEW	RSV4 Factory	09	14	30 mm	TCAAP004NER	
NEW	RSV4 RR	09	14	30 mm	TCAAP004NER	
NEW	RSV4 RR APRC	11	15	30 mm	TCAAP004NER	
NEW	RSV4 RF	15	19	32 mm	TCAAP003NER	
NEW	RSV4 RR	15	16			
NEW	RSV4 RR	17	20	30 mm	TCAAP004NER	
NEW	RSV4 1100 Factory	20	24	30 mm	TCAAP004NER	



TCADU001NER



TCAYA001NER

	Year	Offset	Code	Price
BMW				
NEW	S 1000 RR	19 24	TCABM001NER	
DUCATI				
NEW	Panigale V4	18 23	TCADU001NER	
KAWASAKI				
NEW	ZX 10 R	23	TCAKA001NER	
YAMAHA				
NEW	R1	15 23	TCAYA001NER	

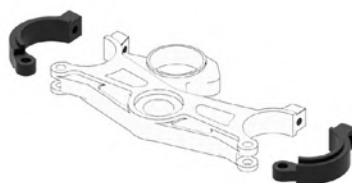

Bracciali per piastra di sterzo per BMW S1000RR 19 - 23
 Triple clamp bracelets for BMW S1000RR 19 - 23
 Pulseras de triple abrazadera para BMW S 1000 RR 19 - 23
 Dreifachklemmarmbänder für BMW S1000RR 19 - 23
 BMW S1000RR 19-23トップブリッジ用ブラケット

TCB001

BRACCIALI MANUBRIO

CLIP-ONS - SOPORTES MANILLAR - LENKERSCHELLEN - セパレートハンドル

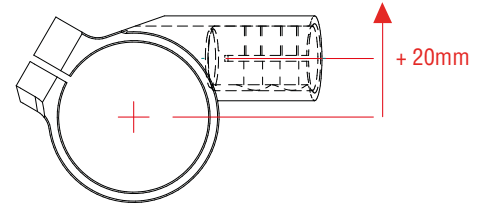

Bracciali manubrio con offset **+20mm**
 Clip-ons with **+20mm** offset
 Puños de manillar con compensación **+20mm**
 Lenkerschellen mit Offset **+20mm**
 ハンドルクランプ +20mm オフセット

Available colours: ●

Ø	Height	Inclination grade	Offset	Code	Price
					for pair
Ø 47	+/- 0mm	10°	+ 20mm	MOZ4701	
Ø 50	+/- 0mm	10°	+ 20mm	MOZ5001	
Ø 51	+/- 0mm	10°	+ 20mm	MOZ5101	
Ø 52	+/- 0mm	10°	+ 20mm	MOZ5201	
Ø 53	+/- 0mm	10°	+ 20mm	MOZ5301	
Ø 54,5	+/- 0mm	10°	+ 20mm	MOZ5401	
Ø 55	+/- 0mm	10°	+ 20mm	MOZ5501	

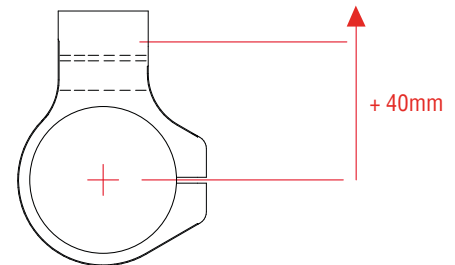

Bracciali manubrio con offset **+40mm**
 Clip-ons with **+40mm** offset
 Puños de manillar con compensación **+40mm**
 Lenkerschellen mit Offset **+40mm**
 ハンドルクランプ +40mm オフセット

Available colours: ●

Ø	Height	Inclination grade	Offset	Code	Price
					for pair
Ø 47	+/- 0mm	10°	+ 40mm	MOZ4710	
Ø 48	+/- 0mm	10°	+ 40mm	MOZ4810	
Ø 50	+/- 0mm	10°	+ 40mm	MOZ5010	
Ø 51	+/- 0mm	5°	+ 40mm	MOZ5110	
Ø 52	+/- 0mm	5°	+ 40mm	MOZ5210	
Ø 53	+/- 0mm	10°	+ 40mm	MOZ5310	
NEW Ø 53	+/- 0mm	10° con supp. A/S	+ 40mm	CLP531040*	
Ø 54,5	+/- 0mm	10°	+ 40mm	MOZ5410	
Ø 55	+/- 0mm	5°	+ 40mm	MOZ5510	

* Con supporto ammortizzatore di sterzo - With steering damper support - Con soporte de amortiguación de dirección Mit Halterung für Lenkungsdämpfer - ステアリングダンパーサポート付き

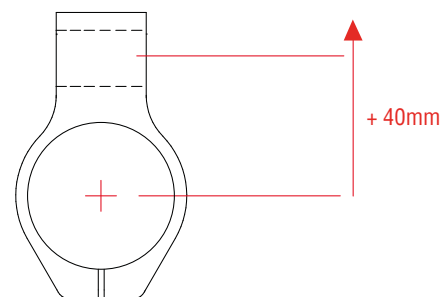

Bracciali manubrio con offset **+20mm**
 Clip-ons with **+20mm** offset
 Puños de manillar con compensación **+20mm**
 Lenkerschellen mit Offset **+20mm**
 ハンドルクランプ **+20mm** オフセット

Available colours: ●

Ø	Height	Inclination grade	Offset	Code	Price
					for pair
NEW Ø 41	+20mm	10°	+ 40mm	CLP412040	
Ø 47	+20mm	10°	+ 40mm	MOZ4720	
Ø 48	+20mm	10°	+ 40mm	MOZ4820	
Ø 50	+20mm	10°	+ 40mm	MOZ5020	
Ø 51	+20mm	6,5°	+ 40mm	MOZ5120	
Ø 55	+20mm	5°	+ 40mm	MOZ5520	



CLP531040

Applicazioni mozzetti

Clip-ons application list - Aplicación del soporte - Verwendungsliste Lenkerschellen - 車種別適合リスト

	Model	Year		Diameter
APRILIA	RS660	20	23	51
	RSV 1000	00	05	51
	RSV 1000 / Factory	06	09	51 Ohlins e K-Tech
	RSV4 R / RR	09	20	51
	RSV4 Factory / APRC / RF	09	18	51 Ohlins
	RSV4 1100 Factory	19	23	51 Ohlins
BMW	S 1000 RR	09	23	55
DUCATI	748-749-916-998-999	94	06	53
	848 / 1098 / 1198	07	11	53
	Panigale V2	20	23	53
	Panigale V4 / S / R	18	23	53
HONDA	CBR 600 RR	07	16	48
	CBR 1000 RR	04	19	50
	CBR 1000 RR-R / SP	20	23	50
KAWASAKI	ZX 400	18	23	41
	ZX 6 R	03	08	50
	ZX 6 R	09	17	51
	ZX 636	09	21	50
	ZX 10 R	04	23	50
MV AUGUSTA	F3 675 / F3 800	12	16	50
SUZUKI	GSXR 600/750	06	07	48
	GSXR 600/750	08	17	50
	GSXR 1000	05	23	50
TRIUMPH	Daytona 675 / 675 R	07	18	50
	Daytona 765	19	20	50
YAMAHA	R3	16	18	41
	R3	19	23	47
	R6	06	23	50
	R7	22	23	50
	R1 / R1M	04	23	50

! END STOCK



	Code	Price
		for pair
length 260mm - internal hole Ø 16.5mm	HBT004NER	
length 260mm - internal hole Ø 15.8mm	HBT009NER	
length 275mm - internal hole Ø 15.8mm	HBT006NER	



Kit tappi per per tubi manubrio HBT006 e HBT009
 Caps kit for HBT006NER and HBT009NER handlebar tubes
 kit de tapones para manillar HBT006NER e HBT009NER
 Kit Deckel für Lenkerstummel HBT006NER Und HBT009NER
 ハンドルバーエンドキャップ (対応品番 : HBT006NER / HBT009NER)

HBT008NER



Protezione acceleratore (Domino Ducati)
 Ducati throttle Protection (Domino Ducati)
 Protección del acelerador (Domino Ducati)
 Gaspedal Schutz für (Domino Ducati)
 (Domino Ducati)用スロットルプロテクション

HBT007NER



Registro precarico molla
 Spring preload adjuster
 Registo de la precarga del muelle
 Federvorspannungseinsteller
 プリロードアジャスター

SPA001NER

BORN
TO BE
MOTO



Kawasaki Ninja 400 RR



CONTRAPPESI MANUBRIO

HANDLEBAR BALANCERS

CONTRAPESOS MANILLAR

STRUKTURIERTE LENKERGEWICHTE

ハンドルバー ウェイト

CONTRAPPESI MANUBRIO

HANDLEBAR BALANCERS - CONTRAPESOS MANILLAR - STRUKTURIERTE LENKERGEWICHTE - ハンドルバー ウェイト

**KTM400**

Contrappesi manubrio in metallo/alluminio
Metal/aluminium handle bar balancers
Contrapesos manillar en metal/aluminio
Strukturierte Lenkergewichte aus Metall/Aluminium
ハンドルバー ウェイト 金属/アルミニウム

Approximate weight per pair: 266 gr

KTM400

! END STOCK 廃盤



silver

cobalt

black

red

gold

green

orange

Kit tappi colorati per **KTM 400**Colored caps kit for **KTM 400**Kit de Tapones de colores para la serie **KTM 400**Farbiges Kappen-Kit für die **KTM 400**バーエンド (品番: **KTM400**) 対応カラーキャップ

for kit

CAP001

! END STOCK 廃盤

**KTM300**

Contrappesi manubrio in alluminio
Aluminium handle bar balancers
Contrapesos manillar en aluminio
Strukturierte Lenkergewichte aus Aluminium
ハンドルバー ウェイト アルミニウム

Approximate weight per pair: 102 gr

KTM300

Available colours: ● ● ● ● ● ● ●

**KTM200**

Contrappesi manubrio in metallo-alluminio
Metal-aluminium handle bar balancers
Contrapesos manillar en metal-aluminio
Strukturierte Lenkergewichte aus Metall-Aluminium
ハンドルバー ウェイト 金属-アルミニウム

Approximate weight per pair: 260 gr

KTM200

Available colours: ● ● ● ● ● ● ●



KTM400 series



! END STOCK 廃盤

	Year		Measure	Code	Price
	from	to			
Universal			d.12/13/17	KTM400	
APRILIA					
RS 660	20	24		KTM431	
RSV4 (all versions)	09	24		KTM403	
BMW					
R Nine-T / Scrambler / Pure / Urban / Racer	16	19		KTM425	
S1000R	14	20		KTM425	
S1000R	21	24		KTM434	
S1000RR	09	18		KTM425	
S1000RR	19	24		KTM430	
CF MOTO					
450 SR	23	24		KTM405	
NK 650	21	24		KTM404	
DUCATI					
Diavel	11	18	d.12	KTM400	
Monster 821	14	20	d.17	KTM400	
Monster 1200 / S / R	17	21		KTM400	
Multistrada	03	09		KTM405	
Panigale 899 / 1199 / 1299	12	17		KTM418	
Panigale 959	16	20		KTM418	
Panigale V2 955	20	24		KTM418	
Panigale V4 / V4 S / V4 R / Speciale	18	24		KTM429	
Streetfighter V2	21	24	d.13	KTM400	
Streetfighter V4 / S	20	24		KTM422	
848	08	11	d.12	KTM400	
1098 / 1198	07	11	d.17	KTM400	
HONDA					
all	-	-		KTM406	
CB 750 Hornet	23	24	d.12/13/17	KTM400	
KAWASAKI					
ER-6N	12	16		KTM404	
Ninja 250 / Ninja 400	18	23		KTM404	
Z125	19	20		KTM404	
Z400	17	23		KTM404	
Z650	17	20		KTM426	
Z750	04	12		KTM404	
Z800	13	16		KTM407	
Z900	17	24		KTM404	
Z1000	03	16		KTM404	
Z1000 SX	11	16		KTM404	
ZX250R	09	12		KTM407	

CONTRAPPESI MANUBRIO

HANDLEBAR BALANCERS - CONTRAPESOS MANILLAR - STRUKTURIERTE LENKERGEWICHTE - ハンドルバー ウェイト

	Year		Measure	Code	Price
	from	to			
KAWASAKI					
ZX 4 RR	24	24		KTM404	
ZX6R / 636	03	23		KTM404	
ZX10R	11	15		KTM404	
ZX10R	16	23		KTM407	
KTM					
Duke 390	17	21		KTM411	
Duke 790	18	24		KTM400	
Duke 890 R	20	23		KTM400	
Duke 1290 R	20	23		KTM400	
MOTO MORINI					
Seiemezzo STR	23	24	d.12	KTM400	
SUZUKI					
Gladius 650	09	15		KTM409	
GSR 600	06	11		KTM405	
GSR 750	11	16		KTM405	
GSXR 600 / 750	00	05		KTM405	
GSXR 600 / 750	06	16		KTM409	
GSXR 1000	03	04		KTM405	
GSXR 1000	05	16		KTM409	
GSXR 1000	17	22		KTM427	
GSXR 750	17	21		KTM428	
GSX-8 R	23	24		KTM435	
GSX-8 S	23	24		KTM435	
GSXS 1000	15	21		KTM400	
TRIUMPH					
Street Triple 675	07	12		KTM400	
Street Triple 675 R	13	16		KTM411	
Street Triple 765 R / S / RS	17	22		KTM411	
YAMAHA					
Fazer 600 - FZ6	04	06		KTM410	
FZ1	06	11		KTM411	
Fazer 1000	01	12		KTM410	
MT-07 / XSR-700	14	24		KTM410	
Tracer 7 / Tracer 7 GT	20	24		KTM436	
MT-09 / SP	13	20		KTM410	
MT-09 / SP	21	22		KTM411	
MT-10	16	21		KTM410	
MT-10	22	23		KTM411	
R 125	08	13		KTM410	
R1	98	24		KTM411	
R3	15	24		KTM411	
R6	06	23		KTM411	
R7	22	24		KTM411	
T Max 500 - 530 - 560	02	21		KTM410	
T Max 560	22	24		KTM433	
X-Max 400	13	19		KTM410	

KTM300 series



	Year		Measure	Color combinations	Code	Price
	from	to				
Universal			d.12/13/17	●●●●●●●●	KTM300	
APRILIA						
RSV4 (all versions)	09	24		●●●●	KTM303	
RSV1000	04	08		●●●●	KTM313	
Shiver 750	07	16		●●●●	KTM313	
Tuono	06	09		●●●●	KTM313	
Tuono V4	11	20		●●●●	KTM313	
BMW						
R Nine-T / Scrambler / Pure / Urban / Racer	16	19		●●●●	KTM325	
S1000R	14	20		●●●●	KTM325	
S1000R	21	24		●●●●	KTM334	
S1000RR	09	18		●●●●	KTM325	
S1000RR	19	24		●●●●	KTM330	
CF MOTO						
NEW 450 SR	23	24		●●	KTM305	
NK 650	21	24		●●●	KTM304	
DUCATI						
Diavel	11	18	d.12	●●●●●●●●	KTM300	
Monster 821	14	20	d.17	●●●●●●●●	KTM300	
Monster 1100	11	13	d.14,5	●●	KTM322	
Monster 1200 / S / R	17	21		●●●●●●●●	KTM300	
Multistrada	03	09		●●	KTM305	
Panigale 899 / 1199 / 1299	12	17		●●	KTM318	
Panigale 959	16	20		●●	KTM318	
Panigale V2 955	20	24		●●	KTM318	
Panigale V4 / V4 S / V4 R / Speciale	18	24		●●	KTM329	
Streetfighter 848 / 1100	08	16	d.14,5	●●	KTM322	
Streetfighter V2	21	24	d.13	●●●●●●●●	KTM300	
Streetfighter V4 / S	20	24	d.14,5	●●	KTM322	
848	08	11	d.12	●●●●●●●●	KTM300	
1098 / 1198	07	11	d.17	●●●●●●●●	KTM300	
HONDA						
all		●●●●●●	KTM306	
CB Hornet 750	23	24	d.12/13/17	●●●●●●●●	KTM300	
KAWASAKI						
ER-6N	12	16		●●●	KTM304	
Ninja 250 / Ninja 400	18	23		●●●	KTM304	
Z125	19	20		●●●	KTM304	
Z400	17	24		●●●	KTM304	
Z650	17	20		●●●	KTM326	
Z750	04	12		●●●	KTM304	
Z800	13	16		●●●	KTM307	
Z900	17	24		●●●	KTM304	
Z1000	03	16		●●●	KTM304	
Z1000 SX	11	16		●●●	KTM304	
ZX250R	09	12		●●●	KTM307	
ZX 4 RR	24	24		●●●	KTM304	
ZX6R / 636	03	23		●●●	KTM304	
ZX10R	11	15		●●●	KTM304	
ZX10R	16	23		●●●	KTM307	

CONTRAPPESI MANUBRIO

HANDLEBAR BALANCERS - CONTRAPESOS MANILLAR - STRUKTURIERTE LENKERGEWICHTE - ハンドルバー ウェイト

	Year		Measure	Color combinations	Code	Price
	from	to				
KTM						
Duke 390	17	21		●●●●●●	KTM311	
Duke 790	18	24		●●●●●●●●	KTM300	
Duke 890 R	20	23		●●●●●●●●	KTM300	
Duke 1290 R	20	23		●●●●●●●●	KTM300	
MOTO MORINI						
Seiamezzo STR	23	24		●●●●●●●●	KTM300	
MV						
Brutale - 4 cilindri	01	17		●●	KTM320	
Brutale B3 - 3 cilindri 675 / 800	12	17		●●	KTM320	
F3 675 / 800	11	17		●●	KTM319	
F4 (all)	10	17		●●	KTM323	
SUZUKI						
Gladius 650	09	15		●●●	KTM309	
GSR 600	06	11		●●●	KTM305	
GSR 750	11	16		●●●	KTM305	
GSXR 600 / 750	00	05		●●●	KTM305	
GSXR 600 / 750	06	16		●●●	KTM309	
GSXR 1000	03	04		●●●	KTM305	
GSXR 1000	05	16		●●●	KTM309	
GSXR 1000	17	22		●●●	KTM327	
GSXS 750	17	21		●●●●	KTM328	
GSX-8 R	24	24		●●●●	KTM335	
GSX-8 S	23	24		●●●●	KTM335	
GSXS 1000	15	21		●●●●●●●●	KTM300	
TRIUMPH						
Street Triple 675	07	12		●●●●●●●●	KTM300	
Street Triple 675 R	13	16		●●●●●●●●	KTM311	
Street Triple 765 R / S / RS	17	22		●●●●●●●●	KTM311	
YAMAHA						
Fazer 600 - FZ6	04	06		●●●●	KTM310	
FZ1	06	11		●●●●●●	KTM311	
Fazer 1000	01	12		●●●●●●	KTM310	
MT-07 / XSR-700	14	24		●●●●●●	KTM310	
Tracer 7 / Tracer 7 GT	20	24		●●●●●●	KTM336	
MT-09 / SP	21	22		●●●●●●●●	KTM311	
MT-10	16	21		●●●●●●	KTM310	
MT-10	22	23		●●●●●●●●	KTM311	
R 125	08	13		●●●●●●	KTM310	
R1 / R1M	98	24		●●●●●●●●	KTM311	
R3	15	24		●●●●●●●●	KTM311	
R6	06	23		●●●●●●●●	KTM311	
R7	22	24		●●●●●●●●	KTM311	
T Max 500 - 530 - 560	02	21		●●●●●●	KTM310	
T Max 560	22	24		●●●●●●	KTM333	
X-Max 400	13	19		●●●●●●	KTM310	

Anelli colorati per **KTM 300**
 Colored rings **KTM 300**
 Anillos de colores para **KTM 300**
 Farbige Ringe für **KTM 300**
 ハンドルバー ウェイト カラー **KTM 300**



for pair

RKTM300

KTM200 series



	Year		Measure	Color combinations	Code	Price
	from	to				
Universal			d.12/13/17		KTM200	
APRILIA						
RS 660	20	24		● ●	KTM231	
RSV4 (all versions)	09	24		● ●	KTM203	
BMW						
R Nine-T / Scrambler / Pure / Urban / Racer	16	19		● ●	KTM225	
S1000R	14	20		● ● ●	KTM225	
S1000R	21	24		● ● ●	KTM234	
S1000RR	09	18		● ● ●	KTM225	
S1000RR	19	24		● ● ●	KTM230	
CF MOTO						
NEW 450 SR	23	24		● ●	KTM205	
NK 650	21	24		● ●	KTM204	
DUCATI						
Diavel	11	18	d.12	● ●	KTM200	
Monster 821	14	20	d.17	● ●	KTM200	
Monster 1200 / S / R	17	21		● ●	KTM200	
Multistrada	03	09		● ●	KTM205	
Panigale 899 / 1199 / 1299	12	17		● ●	KTM218	
Panigale 959	16	20		● ●	KTM218	
Panigale V2 955	20	24		● ●	KTM218	
Panigale V4 / V4 S / V4 R / Speciale	18	24		● ●	KTM229	
Streetfighter V2	21	24	d.13	● ●	KTM200	
Streetfighter V4 / S	20	24	d.14,5	● ●	KTM222	
848	08	11	d.12	● ●	KTM200	
1098 / 1198	07	11	d.17	● ●	KTM200	
HONDA						
all		● ●	KTM206	
CB Hornet 750	23	24	d.12/13/17	● ●	KTM200	
KAWASAKI						
ER-6N	12	16		● ● ●	KTM204	
Ninja 250 / Ninja 300 / Ninja 400	18	23		● ● ●	KTM204	
Z125	19	20		● ● ●	KTM204	
Z400	17	23		● ● ●	KTM204	
Z650	17	20		● ● ●	KTM226	
Z750	04	12		● ● ●	KTM204	
Z800	13	16		● ● ●	KTM207	
Z900	17	24		● ● ●	KTM204	
Z1000	03	16		● ● ●	KTM204	
Z1000 SX	11	16		● ● ●	KTM204	
ZX250R	09	12		● ● ●	KTM207	
ZX 4 RR	24	24		● ● ●	KTM204	
ZX6R / 636	03	23		● ● ●	KTM204	

CONTRAPPESI MANUBRIO

HANDLEBAR BALANCERS - CONTRAPESOS MANILLAR - STRUKTURIERTE LENKERGEWICHTE - ハンドルバー ウェイト

	Year		Measure	Color combinations	Code	Price
	from	to				
KAWASAKI						
ZX10R	11	15		● ● ●	KTM204	
ZX10R	16	24		● ● ●	KTM207	
KTM						
Duke 390	17	21		● ● ●	KTM211	
Duke 790	18	24		● ● ●	KTM200	
Duke 890 R	20	23		● ● ●	KTM200	
Duke 1290 R	20	23		● ● ●	KTM200	
MOTO MORINI						
Seiemezzo STR	23	24	d.12	● ●	KTM200	
MV						
Brutale - 4 cilindri	01	17		● ●	KTM220	
Brutale B3 - 3 cilindri 675 / 800	12	17		● ●	KTM220	
F3 675 / 800	11	17		● ●	KTM219	
F4	10	17		● ●	KTM223	
SUZUKI						
Gladius 650	09	15		● ● ●	KTM209	
GSR 600	06	11		● ● ●	KTM205	
GSR 750	11	16		● ● ●	KTM205	
GSXR 600 / 750	00	05		● ● ●	KTM205	
GSXR 600 / 750	06	17		● ● ●	KTM209	
GSXR 1000	03	04		● ● ●	KTM205	
GSXR 1000	05	16		● ● ●	KTM209	
GSXR 1000	17	22		● ● ●	KTM227	
GSXS 750	17	21		● ● ●	KTM228	
GSX-8 R	24	24		● ● ●	KTM235	
GSX-8 S	23	24		● ● ●	KTM235	
GSXS 1000	15	21		● ● ●	KTM200	
TRIUMPH						
Street Triple 675	07	12		● ●	KTM200	
Street Triple 675 R	13	16		● ●	KTM211	
Street Triple 765 R / S / RS	17	22		● ●	KTM211	
YAMAHA						
Fazer 600 - FZ6	04	06		● ● ●	KTM210	
FZ1	06	11		● ● ●	KTM211	
Fazer 1000	01	12		● ● ●	KTM210	
MT-07 / XSR-700	14	24		● ● ●	KTM210	
Tracer 7 / Tracer 7 GT	20	24		● ● ●	KTM236	
MT-09 / SP	13	20		● ● ●	KTM210	
MT-09 / SP	21	22		● ● ●	KTM211	
MT-10	16	21		● ● ●	KTM210	
MT-10	22	23		● ● ●	KTM211	
R 125	08	13		● ● ●	KTM210	
R1 / R1M	98	24		● ● ●	KTM211	
R3	15	24		● ● ●	KTM211	
R6	06	23		● ● ●	KTM211	
R7	22	24		● ● ●	KTM211	
T Max 500 - 530 - 560	02	21		● ● ●	KTM210	
T Max 560	22	24		● ● ●	KTM233	
X-Max 400	13	19		● ● ●	KTM210	



TAPPI SERBATOIO
FUEL TANK CAPS
TAPÓN DEPOSITO
TANKDECKEL
フューエル タンク キャップ

TAPPI SERBATOIO

FUEL TANK CAPS - TAPÓN DEPOSITO - TANKDECKEL - フューエルタンクキャップ

 100%
Made in Italy

NEW
DESIGN



Chiusura **PUSH & PULL**
PUSH & PULL closure
 Cierre **PUSH & PULL**
PUSH & PULL Verschluss
 「プッシュ&プル」で開閉可能

NEW FUEL CAPS
by Lightech

Nuova gamma di tappi a sgancio rapido
 New range of quick release fuel tank caps
 Nueva gama de tapones de depósito de apertura rápida
 Neue Reihe von Tankdeckeln mit Schnellverschluss
 新しいクイックリリース フューエルタンクキャップ

Interamente ricavati dal pieno
 Entirely machined from solid
 Totalmente realizado CNC
 Aus einem Block gewonnen
 アルミブロックから機械加工により削り出されています



		Year		Code	Price
					
APRILIA					
	RS 660	20	24	TRN214	●●
	Tuono 660	20	24	TRN214	●●
NEW	RSV 1000	04	08	TRN229	●●
NEW	RSV4 (all versions)	09	24	TRN229	●●
NEW	Tuono V4 (all versions)	11	24	TRN229	●●
BMW					
	S 1000 R	14	20	TRN211	●●●
	S 1000 R	21	24	TRN230	●●●
	S 1000 RR	09	20	TRN211	●●●
	S 1000 RR	21	24	TRN230	●●●
DUCATI					
	Monster 821	14	17	TRN226	●●●●●
	Monster 1200 / R	17	21	TRN226	●●●●●
NEW	Panigale 899 / 959 / 1199 / 1299	12	17	TRN228	●●●
NEW	Panigale V2 / V4 / S / R	18	24	TRN228	●●●
NEW	Streetfighter 848 / 1100	09	16	TRN228	●●●
NEW	Streetfighter V2 / S	21	24	TRN228	●●●
NEW	Streetfighter V4 / S	20	24	TRN228	●●●



	Year			Code	Price
					
HONDA					
CB 650 R	21	24		TRN227 ●●	
CB 750 Hornet	23	24		TRN227 ●●	
CBR 1000 RR-R / SP	20	24		TRN227 ●●	
KAWASAKI					
ER - 6N	12	16		TRN215 ●●●	
Ninja 400	17	23		TRN223 ●●●	
Ninja 1000 SX	21	22		TRN223 ●●●	
Z 400	17	24		TRN223 ●●●	
Z 650	17	22		TRN223 ●●●	
Z 750 / Z750 R	07	12		TRN215 ●●●	
Z 800	13	16		TRN215 ●●●	
Z 900	17	23		TRN223 ●●●	
Z 1000 / Z 1000SX	10	20		TRN215 ●●●	
ZX 4 RR	24	24		TRN223 ●●●	
ZX 6 R / ZX636	07	18		TRN215 ●●●	
ZX636	19	21		TRN223 ●●●	
ZX 10 R	06	20		TRN215 ●●●	
ZX 10 R	21	24		TRN223 ●●●	
KTM					
Duke 790 / 890 R	18	23		TR25 ●	
MV AGUSTA					
Brutale	01	12		TRN226 ●●●●●	
F4	97	09		TRN226 ●●●●●	
SUZUKI					
GSR 600	06	11		TRN220 ●●●	
GSR 750	11	16		TRN220 ●●●	
GSXR 600 / 750	04	17		TRN220 ●●●	
GSXR 1000	03	16		TRN220 ●●●	
GSXR 1000	17	22		TRN220 ●●●	
GSXS 750	17	20		TRN220 ●●●	
GSXS 1000	15	23		TRN220 ●●●	
TRIUMPH					
Daytona 675 / 675 R	11	18		TRN214 ●●	
Speed Triple 1050	11	18		TRN214 ●●	
Street Triple 675 / 675 R	11	16		TRN214 ●●	
Street Triple 765 S / 765 R / RS	17	24		TRN214 ●●	
YAMAHA					
MT-07 / MT-07 Tracer / Tracer 7 / Tracer 7 GT	14	24		TRN226 ●●●●●	
MT-09 / SP / Tracer 9 / Tracer 9 GT	13	24		TRN226 ●●●●●	
MT-10	16	23		TRN226 ●●●●●	
R1 / R1M	04	24		TRN226 ●●●●●	
R3	15	24		TRN226 ●●●●●	
R6	08	23		TRN226 ●●●●●	
R7	22	24		TRN226 ●●●●●	
XSR700	17	20		TRN226 ●●●●●	

TAPPI SERBATOIO

FUEL TANK CAPS - TAPÓN DEPOSITO - TANKDECKEL - フューエル タンク キャップ



 100%
Made in Italy

SPIN LOCKING CAPS COLOURED CAPS

Year	Code	Price
		

APRILIA

RS 660	20	24	TFN214	●●	
RSV 1000	04	08	TFN229	●●	
NEW RSV4 R (all versions)	09	24	TFN229	●●	
NEW Tuono 660	20	24	TFN214	●●	
NEW Tuono V4 (all versions)	11	24	TFN229	●●	

BMW

S 1000 R	14	20	TFN211	●●●	
S 1000 R	21	24	TFN230	●●●	
S 1000 RR	09	20	TFN211	●●●	
S 1000 RR	21	24	TFN230	●●●	

DUCATI

Monster 821	14	17	TFN226	●●●●●	
Monster 1200 / R	17	21	TFN226	●●●●●	
NEW Panigale 899 / 959 / 1199 / 1299 / V2 / V4 / S	12	17	TFN228	●●●	
NEW Panigale V2 / V4 / S / R	18	24	TFN228	●●●	
NEW Streetfighter 848 / 1100	09	16	TFN228	●●●	
NEW Streetfighter V2 / S	21	24	TFN228	●●●	
NEW Streetfighter V4 / S	20	24	TFN228	●●●	

HONDA

CB 125 R	18	20	TFN224	●●	
CB 300 R	18	20	TFN224	●●	
CB 650 R	18	24	TFN224	●●	
CB 650 R	21	24	TFN227	●●	
CB 750 Hornet	23	24	TFN227	●●	
CB 1000 R	18	20	TFN224	●●	
CB 500 R	16	20	TFN224	●●	
CBR 1000 RR	17	19	TFN224	●●	
CBR 1000 RR-R / SP	20	24	TFN227	●●	



SPIN LOCKING CAPS COLOURED CAPS

Year	Code	Price
		

KAWASAKI						
ER - 6N	12	16	TFN215	●●●●		
Ninja 400	17	23	TFN223	●●●●		
Ninja 1000 SX	21	22	TFN223	●●●●		
Z 400	17	24	TFN223	●●●●		
Z 650	17	22	TFN223	●●●●		
Z 750 / Z750 R	07	12	TFN215	●●●●		
Z 800	13	16	TFN215	●●●●		
Z 900	17	23	TFN223	●●●●		
Z 1000 / Z 1000SX	10	20	TFN215	●●●●		
ZX 4 RR	24	24	TFN223	●●●●		
ZX 6 R / ZX636	07	18	TFN215	●●●●		
ZX636	19	21	TFN223	●●●●		
ZX 10 R	06	20	TFN215	●●●●		
ZX 10 R	21	24	TFN223	●●●●		

KTM						
Duke 790 / 890 R	18	23	TF25	●		

MV AGUSTA						
Brutale	01	12	TFN226	●●●●●●		
F4	97	09	TFN226	●●●●●●		

SUZUKI						
GSR 600	06	11	TFN220	●●●●		
GSR 750	11	16	TFN220	●●●●		
GSXR 600 / 750	04	17	TFN220	●●●●		
GSXR 1000	03	16	TFN220	●●●●		
GSXR 1000	17	22	TFN220	●●●●		
GSXS 750	17	20	TFN220	●●●●		
GSXS 1000	15	23	TFN220	●●●●		

TRIUMPH						
Daytona 675 / 675 R	11	18	TFN214	●●		
Speed Triple 1050	11	18	TFN214	●●		
Street Triple 675 / 675 R	11	16	TFN214	●●		
Street Triple 765 S / 765 R / RS	17	24	TFN214	●●		

YAMAHA						
MT-07 / MT-07 Tracer / Tracer 7 / Tracer 7 GT	14	24	TFN226	●●●●●●		
MT-09 / SP / Tracer 9 / Tracer 9 GT	13	24	TFN226	●●●●●●		
MT-10	16	23	TFN226	●●●●●●		
R1 / R1M	04	24	TFN226	●●●●●●		
R3	15	24	TFN226	●●●●●●		
R6	08	23	TFN226	●●●●●●		
R7	22	24	TFN226	●●●●●●		
XSR700	17	20	TFN226	●●●●●●		

TAPPI SERBATOIO

FUEL TANK CAPS - TAPÓN DEPOSITO - TANKDECKEL - フューエル タンク キャップ

NEW
DESIGN

FCR Model

Ricambio flangia interna per tappo a sgancio rapido
Internal spare part for quick release fuel tank cap
Recambio de la pieza interna del tapon de apertura rapida
Internes Ersatzteil für Schnellverschluss-Tankdeckel
クリックリリースタイプ用スペアキャップ

FCR

Available colours: ●●●●●●

FCF Model

Ricambio flangia interna per tappo filettato
Internal spare part for spin locking fuel tank cap
Recambio de la pieza interna de tapon con rosca
Internes Ersatzteil für Drehverschluss-Tankdeckel
スピンロッキングタイプ用スペアキャップ

FCF

Available colours: ●●●●●●



Chiave racing universale per tappo serbatoio e tappo olio
Universal racing key for fuel tank cap and oil filler cap
Llave racing universal para tapón deposito y tapón aceite
Universeller racing Schlüssel für Tankdeckel und Öldeckel
フューエルタンクキャップ・オイルフィラーキャップ用ユニバーサルレーシングキー

TFT



TFN229 / TFN228



Bocchetta olio con involucro in alluminio **uscita laterale**
 Fluid tank for brake and clutch with aluminium body and **side spout**
 Deposito di freno con carcass en aluminio con **salida lateral**
 Bremsölbehälter mit Aluminiumschale und **Seitlichem Ausgang**
 アルミニウム オイルリザーバータンク (ブレーキ/クラッチ)

OBT006

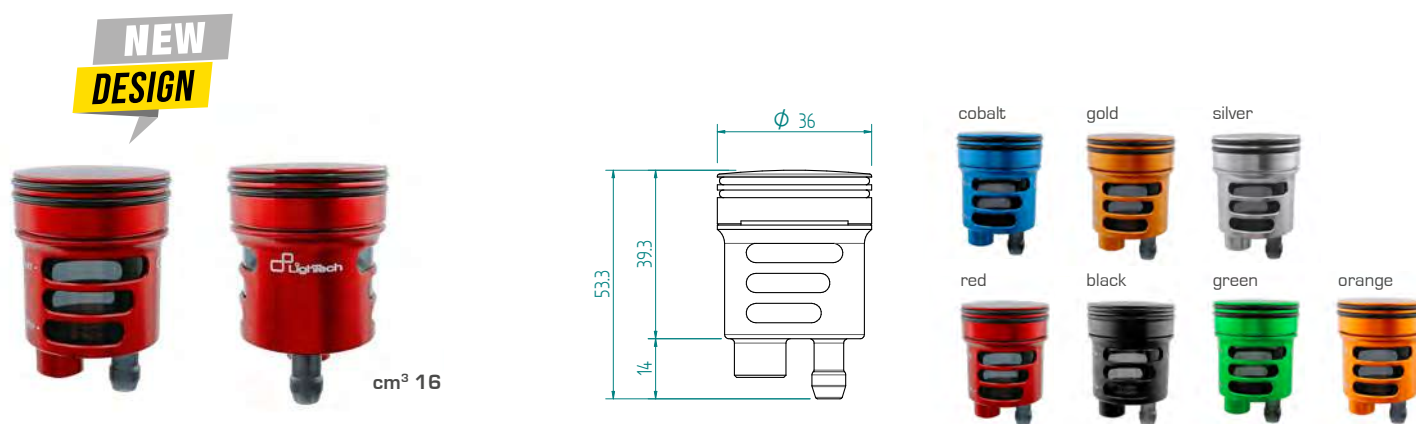

Bocchetta olio con involucro in alluminio **uscita laterale**
 Fluid tank for brake and clutch with aluminium body and **side spout**
 Deposito di freno con carcass en aluminio con **salida lateral**
 Bremsölbehälter mit Aluminiumschale und **Seitlichem Ausgang**
 アルミニウム オイルリザーバータンク (ブレーキ/クラッチ)

OBT007



Supporto per OBT006/OBT007
Holder for OBT006/OBT007
Soporte para OBT006/OBT007
Support für OBT006/OBT007
OBT006・OBT007用ホルダー



OBT003

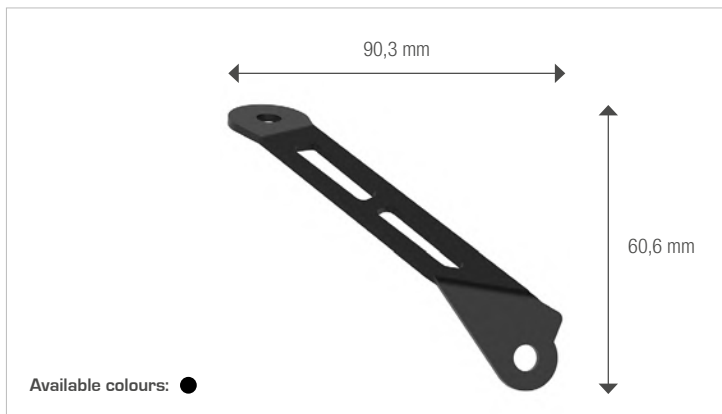

Supporto per OBT006/OBT007
Holder for OBT006/OBT007
Soporte para OBT006/OBT007
Support für OBT006/OBT007
OBT006・OBT007用ホルダー

OBT008NER



Supporto per OBT006/OBT007
Holder for OBT006/OBT007
Soporte para OBT006/OBT007
Support für OBT006/OBT007
OBT006・OBT007用ホルダー

OBT009NER

TAPPI OLIO
OIL FILLER CAPS
TAPÓN ACEITE
ÖLVERSCHLUSSSCHRAUBE
オイル フィラー キャップ



TAPPI OLIO

OIL FILLER CAPS - TAPÓN ACEITE - ÖLVERSCHLUSSSCHRAUBE - オイル フィラー キャップ



Available colours: ● ● ● ● ● ●



! END STOCK

	Year		Thread	Code	Price	Code	Price
APRILIA							
Dorsoduro 750	08	13	M 25 X 1,5	OIL 102		OIL 002	
Dorsoduro 750	14	16	M 20 X 1,5	OIL 101		OIL 001	
Dorsoduro 900	18	21	M 20 X 1,5	OIL 101		OIL 001	
Dorsoduro 1200	11	16	M 20 X 1,5	OIL 101		OIL 001	
RSV 4 (all versions)	09	24	M 25 X 1,5	OIL 102		OIL 002	
RS 660	20	24	M 20 X 1,5	OIL 101		OIL 001	
Shiver 750	07	15	M 25 X 1,5	OIL 102		OIL 002	
Tuono	06	09	M 20 X 1,5	OIL 101		OIL 001	
Tuono V4	11	24	M 25 X 1,5	OIL 102		OIL 002	
BMW							
R Nine-T / Scrambler / Pure / Urban / Racer	16	19	M 34 x 1,5	OIL 108		OIL 008	
R 1200 GS	08	12	M 34 x 1,5	OIL 108		OIL 008	
S1000 R	14	24	M 24 X 2	OIL 107		OIL 007	
S1000 RR	09	24	M 24 X 2	OIL 107		OIL 007	
DUCATI							
848	08	10	M 20 X 2,5	OIL 111		OIL 011	
1098 - 1198	07	11	M 22 X 1,5	OIL 103		OIL 003	
Hypermotard 796	09	12	M 20 X 2,5	OIL 111		OIL 011	
Hypermotard 821 / Hyperstrada 821	13	15	M 20 X 2,5	OIL 111		OIL 011	
Hypermotard 939	16	18	M 20 X 2,5	OIL 111		OIL 011	
Hypermotard 950	19	24	M 20 X 2,5	OIL 111		OIL 011	
Monster 696	08	15	M 19,5 X 2,5	OIL 104		OIL 004	
Monster 821	14	19	M 20 X 2,5	OIL 111		OIL 011	
Monster 937	21	24	M 20 X 2,5	OIL 111		OIL 011	
Monster 1100	11	13	M 20 X 2,5	OIL 111		OIL 011	
Monster 1200 / 1200S	14	21	M 20 X 2,5	OIL 111		OIL 011	
Multistrada 1200	10	13	M 19,5 X 2,5	OIL 104		OIL 004	
Multistrada V4 / S	21	24	M 19,5 X 2,5	OIL 111		OIL 011	
Panigale 1199 / 899	12	15	M 19,5 X 2,5	OIL 104		OIL 004	
Panigale V2 / 955	20	24	M 19,5 X 2,5	OIL 104		OIL 004	
Panigale 1299 / V4 (all versions)	15	24	M 20 X 2,5	OIL 111		OIL 011	
Streetfighter 848	11	16	M 20 X 2,5	OIL 111		OIL 011	
Streetfighter 1100	09	15	M 22 X 1,5	OIL 103		OIL 003	
Streetfighter V2 / S	22	24	M 19,5 X 2,5	OIL 104		OIL 004	
Streetfighter V4 / S	20	24	M 20 X 2,5	OIL 111		OIL 011	
GUZZI							
Griso 850 / 1100 / 1150	06	15	M 20 X 1,5	OIL 101		OIL 001	
HONDA							
all	-	-	M 19,5 X 2,5	OIL 104		OIL 004	
CB 500 R	16	24	M 19,5 X 2,5	OIL 104		OIL 004	
CB 650 R	19	24	M 20 X 2,5	OIL 111		OIL 011	
CB 750 Hornet	23	24	M 20 X 2,5	OIL 111		OIL 011	
CB 600 RR		24					
CBR 1000 RR-R / SP	20	24	M 20 X 2,5	OIL 111		OIL 011	
XADV	17	24	M 20 X 2,5	OIL 111		OIL 011	



! END STOCK

KAWASAKI								
ER 6N	06	15	M 19,5 X 2,5	OIL 104			OIL 004	
Ninja 400	18	23	M 20 X 2,5	OIL 111			OIL 011	
Z125	19	20	M 20 X 2,5	OIL 111			OIL 011	
Z400	17	24	M 20 X 2,5	OIL 111			OIL 011	
Z 650	17	24	M 20 X 2,5	OIL 111			OIL 011	
Z 800	13	16	M 20 X 2,5	OIL 111			OIL 011	
Z 900	17	23	M 20 X 2,5	OIL 111			OIL 011	
Z 1000	03	09	M 30 X 1,5	OIL 105			OIL 005	
Z 1000	10	19	M 20 X 2,5	OIL 111			OIL 011	
Z 1000 SX	11	19	M 20 X 2,5	OIL 111			OIL 011	
ZX 4 RR	24	24	M 20 X 2,5	OIL 111			OIL 011	
ZX6R / 636	05	24	M 30 X 1,5	OIL 105			OIL 005	
ZX10R	04	24	M 30 X 1,5	OIL 105			OIL 005	
KTM								
Duke 790	18	24	M 24 X 3	OIL 113			OIL 013	
Duke 890 R	20	24	M 24 X 3	OIL 113			OIL 013	
Duke 1290 R	20	24	M 24 X 3	OIL 113			OIL 013	
MV AGUSTA								
Brutale 750 / 910 / 990 / 1090	00	17	M 25 X 1,5	OIL 102			OIL 002	
B3 675 / 800	12	17	M 24 X 3	OIL 113			OIL 013	
F3 675 / 800	12	17	M 24 X 3	OIL 113			OIL 013	
F4 750 / 910 / 990 / 1090	00	17	M 25 X 1,5	OIL 102			OIL 002	
Rivale 800	13	17	M 24 X 3	OIL 113			OIL 013	
SUZUKI								
GSXR 600 / 750	06	10	M 20 X 1,5	OIL 101			OIL 001	
GSXR 600 / 750	11	17	M 20 X 1,5	OIL 101			OIL 001	
GSXR 1000	07	11	M 20 X 1,5	OIL 101			OIL 001	
GSXR 1000	12	16	M 20 X 1,5	OIL 101			OIL 001	
GSXR 1000	17	23	M 20 X 1,5	OIL 101			OIL 001	
GSX-S 750	17	21	M 20 X 1,5	OIL 101			OIL 001	
GSX-8 S	23	24						
GSX-S 1000	15	23	M 20 X 1,5	OIL 101			OIL 001	
TRIUMPH								
all	-	-	M 19,5 X 2,5	OIL 104			OIL 004	
Street Triple RS 1200	21	24	M 20 X 2,5	OIL 111			OIL 011	
Street Triple 765S / 765R / 765RS	17	24	M 20 X 2,5	OIL 111			OIL 011	
YAMAHA								
MT-03 (660CC) monocilindrico	06	14	M 19,5 X 2,5	OIL 104			OIL 004	
MT-03 (321CC) bicilindrico	16	24	M 26 X 3	OIL 106			OIL 006	
MT-07 / MT-07 Tracer / XMT-07 / Tracer 7 / Tracer 7 GT	14	24	M 26 X 3	OIL 106			OIL 006	
MT-09 / SP / Tracer 9 / Tracer 9 GT	13	24	M 20 X 2,5	OIL 111			OIL 011	
MT-10	16	21	M 26 X 3	OIL 106			OIL 006	
R1 / R1M	00	24	M 26 X 3	OIL 106			OIL 006	
R3	15	24	M 26 X 3	OIL 106			OIL 006	
R6	06	24	M 26 X 3	OIL 106			OIL 006	
R7	22	24	M 26 X 3	OIL 106			OIL 006	
T-Max 500 / 530 / 560	08	24	M 19,5 X 2,5	OIL 104			OIL 004	

COPERCHI POMPE FRENO E FRIZIONE - CLUTCH/BRAKE PUMP RESERVOIR COVERS

TAPAS BOMBA FRENO Y EMBRAGUE - BREMSPUMPEN UND KUPPLUNGSDECKEL - クラッチ・ブレーキオイルリザーバーカバー



FFC06



FBC19



FBC18



FBC17



FBC06



FFC03



FBC07



FBC27

	Year		Article	Code	Price
	from	to			
APRILIA					
Dorsoduro 750	09	16	freno ant. / front brake / freno delantero / vordere Bremse / フロントブレーキ	● ●	FBC17
			freno post. / rear brake / freno trasero / hintere Bremse / リアブレーキ	● ● ● ● ● ●	FFC05
			frizione / clutch / embrague / Kupplung / クラッチ	● ●	FFC06
Dorsoduro 900	18	20	freno ant. / front brake / freno delantero / vordere Bremse / フロントブレーキ	● ●	FBC17
			freno post. / rear brake / freno trasero / hintere Bremse / リアブレーキ	● ● ● ● ● ●	FFC05
			frizione / clutch / embrague / Kupplung / クラッチ	● ●	FFC06
RSV 4 (all versions)	09	24	freno ant. / front brake / freno delantero / vordere Bremse / フロントブレーキ	● ● ● ● ● ● ●	FBC04
RS 660 / Tuono 660	21	24	freno ant. / front brake / freno delantero / vordere Bremse / フロントブレーキ	● ● ● ● ● ● ●	FBC04
			freno post. / rear brake / freno trasero / hintere Bremse / リアブレーキ	● ●	FFC03
Shiver 750	07	16	freno post. / rear brake / freno trasero / hintere Bremse / リアブレーキ	● ● ● ● ● ●	FFC05
Tuono V4	11	24	freno ant. / front brake / freno delantero / vordere Bremse / フロントブレーキ	● ● ● ● ● ● ●	FBC04
BMW					
R Nine-T / Scrambler / Pure / Urban / Racer	16	19	freno ant. / front brake / freno delantero / vordere Bremse / フロントブレーキ	● ● ● ● ●	FBC25
			frizione / clutch / embrague / Kupplung / クラッチ	● ●	FFC11
S 1000 R	14	21	freno ant. / front brake / freno delantero / vordere Bremse / フロントブレーキ	● ● ● ● ● ● ●	FBC06
S 1000 R	22	24	freno ant. / front brake / freno delantero / vordere Bremse / フロントブレーキ	● ● ● ● ● ●	FBC25
S 1000 RR	09	24	freno ant. / front brake / freno delantero / vordere Bremse / フロントブレーキ	● ● ● ● ● ● ●	FBC06
CF MOTO					
450 SR	23	24	freno ant. / front brake / freno delantero / vordere Bremse / フロントブレーキ	● ● ● ● ● ●	FBC06
DUCATI					
848 / 1098 / 1198	07	11	freno ant. / front brake / freno delantero / vordere Bremse / フロントブレーキ	● ● ● ● ● ● ●	FBC04
			freno post. / rear brake / freno trasero / hintere Bremse / リアブレーキ	● ●	FFC03
			frizione / clutch / embrague / Kupplung / クラッチ	● ●	FFC03
Hypermotard 821 / 939	12	17	freno ant. / front brake / freno delantero / vordere Bremse / フロントブレーキ	● ●	FBC07
			freno post. / rear brake / freno trasero / hintere Bremse / リアブレーキ	● ●	FFC03
Hypermotard 950 / SP	19	24	freno ant. / front brake / freno delantero / vordere Bremse / フロントブレーキ	● ● ● ● ● ● ●	FBC04
			freno post. / rear brake / freno trasero / hintere Bremse / リアブレーキ	● ●	FFC03
			frizione / clutch / embrague / Kupplung / クラッチ	● ● ● ● ● ● ●	FBC27
Hypermotard 1100	07	10	freno ant. / front brake / freno delantero / vordere Bremse / フロントブレーキ	● ● ● ● ● ● ●	FBC04
			freno post. / rear brake / freno trasero / hintere Bremse / リアブレーキ	● ●	FFC03
			frizione / clutch / embrague / Kupplung / クラッチ	● ●	FFC03
Monster 696 / 796	08	15	freno ant. / front brake / freno delantero / vordere Bremse / フロントブレーキ	● ●	FBC07
			freno post. / rear brake / freno trasero / hintere Bremse / リアブレーキ	● ●	FFC03
			frizione / clutch / embrague / Kupplung / クラッチ	● ●	FFC04
Monster 821	14	17	freno ant. / front brake / freno delantero / vordere Bremse / フロントブレーキ	● ●	FBC07
			freno post. / rear brake / freno trasero / hintere Bremse / リアブレーキ	● ●	FFC03
Monster 1100	11	13	freno post. / rear brake / freno trasero / hintere Bremse / リアブレーキ	● ●	FFC03
Monster 1200 / 1200S	14	21	freno ant. / front brake / freno delantero / vordere Bremse / フロントブレーキ	● ● ● ● ● ● ●	FBC04
			freno post. / rear brake / freno trasero / hintere Bremse / リアブレーキ	● ●	FFC03
			frizione / clutch / embrague / Kupplung / クラッチ		FBC27

COPERCHI POMPE FRENO E FRIZIONE - CLUTCH/ BRAKE PUMP RESERVOIR COVERS
 TAPAS BOMBA FRENO Y EMBRAGUE - BREMSPUMPEN UND KUPPLUNGSDECKEL - クラッチ・ブレーキオイルリザーバーカバー



FBC01



FBC02



FBC04



FBC11

	Year		Article	Code	Price
	from	to			
DUCATI					
Multistrada 1200	10	12	freno ant. / front brake / freno delantero / vordere Bremse / フロント ブレーキ	●●●●●●	FBC04
			freno post. / rear brake / freno trasero / hintere Bremse / リア ブレーキ	●●	FFC03
			frizione / clutch / embrague / Kupplung / クラッチ	●●	FFC03
Multistrada V4	21	24	freno ant. / front brake / freno delantero / vordere Bremse / フロント ブレーキ	●●	FBC04
			frizione / clutch / embrague / Kupplung / クラッチ	●●	FFC27
Panigale 959	16	20	freno ant. / front brake / freno delantero / vordere Bremse / フロント ブレーキ	●●●●●●	FBC04
			freno post. / rear brake / freno trasero / hintere Bremse / リア ブレーキ	●●	FFC03
			frizione / clutch / embrague / Kupplung / クラッチ	●●	FFC03
Panigale V2 955	21	24	freno ant. / front brake / freno delantero / vordere Bremse / フロント ブレーキ	●●●●●●	FBC04
			freno post. / rear brake / freno trasero / hintere Bremse / リア ブレーキ	●●	FFC03
			frizione / clutch / embrague / Kupplung / クラッチ	●●●●●●	FBC27
Panigale 1199 / 1299	12	17	freno ant. / front brake / freno delantero / vordere Bremse / フロント ブレーキ	●●●●●●	FBC04
			freno post. / rear brake / freno trasero / hintere Bremse / リア ブレーキ	●●	FFC03
			frizione / clutch / embrague / Kupplung / クラッチ	●●	FFC03
Panigale V4 / S / R	18	19	freno ant. / front brake / freno delantero / vordere Bremse / フロント ブレーキ	●●●●●●	FBC04
			freno post. / rear brake / freno trasero / hintere Bremse / リア ブレーキ	●●	FFC03
			frizione / clutch / embrague / Kupplung / クラッチ	●●●●●●	FBC27
Panigale V4 / S / R	20	24	freno ant. / front brake / freno delantero / vordere Bremse / フロント ブレーキ	●●●●●●	FBC04
			freno post. / rear brake / freno trasero / hintere Bremse / リア ブレーキ	●●●●●●	FBC27
			frizione / clutch / embrague / Kupplung / クラッチ	●●●●●●	FBC27
Streetfighter 848 / 1100	09	16	freno ant. / front brake / freno delantero / vordere Bremse / フロント ブレーキ	●●	FBC18
			freno post. / rear brake / freno trasero / hintere Bremse / リア ブレーキ	●●	FFC03
			frizione / clutch / embrague / Kupplung / クラッチ	●●	FFC07
Streetfighter V2 / S	22	24	freno ant. / front brake / freno delantero / vordere Bremse / フロント ブレーキ	●●●●●●	FBC04
			freno post. / rear brake / freno trasero / hintere Bremse / リア ブレーキ	●●●●●●	FBC27
			frizione / clutch / embrague / Kupplung / クラッチ	●●●●●●	FBC27
Streetfighter V4 / S	21	24	freno ant. / front brake / freno delantero / vordere Bremse / フロント ブレーキ	●●●●●●	FBC04
			freno post. / rear brake / freno trasero / hintere Bremse / リア ブレーキ	●●●●●●	FBC27
			frizione / clutch / embrague / Kupplung / クラッチ	●●●●●●	FBC27
HONDA					
CB 125 R	18	22	freno post. / rear brake / freno trasero / hintere Bremse / リア ブレーキ	●●●	FBC28
CB 650F	14	15	freno ant. / front brake / freno delantero / vordere Bremse / フロント ブレーキ	●●	FBC01
CB 650R	19	22	freno ant. / front brake / freno delantero / vordere Bremse / フロント ブレーキ	●●	FBC01
CB 1000 R	08	17	freno ant. / front brake / freno delantero / vordere Bremse / フロント ブレーキ	●●●●●●	FBC06
			freno post. / rear brake / freno trasero / hintere Bremse / リア ブレーキ	●●●●●●	FBC06
			frizione / clutch / embrague / Kupplung / クラッチ	●●●●●●	FFC05
CB 1000 R	18	24	freno ant. / front brake / freno delantero / vordere Bremse / フロント ブレーキ	●●●	FBC29
			freno post. / rear brake / freno trasero / hintere Bremse / リア ブレーキ	●●●	FBC28
CBR 500 R	16	20	freno post. / rear brake / freno trasero / hintere Bremse / リア ブレーキ	●●●	FBC28
CBR 600 RR	03	06	freno ant. / front brake / freno delantero / vordere Bremse / フロント ブレーキ	●●	FBC01
CBR 600 RR	07	16	freno ant. / front brake / freno delantero / vordere Bremse / フロント ブレーキ	●●●●●●	FBC06
CBR 1000 RR	08	17	freno ant. / front brake / freno delantero / vordere Bremse / フロント ブレーキ	●●●●●●	FBC06
			freno post. / rear brake / freno trasero / hintere Bremse / リア ブレーキ	●●●●●●	FFC05
CBR 1000 RR-R	20	24	freno ant. / front brake / freno delantero / vordere Bremse / フロント ブレーキ	●●●●●●	FBC06
CBR 1000 RR-R SP	20	24	freno ant. / front brake / freno delantero / vordere Bremse / フロント ブレーキ	●●●●●●	FBC04
Hornet 600	11	13	freno ant. / front brake / freno delantero / vordere Bremse / フロント ブレーキ	●●	FBC01
XADV	17	24	freno destro / right brake / freno derecho / rechte Bremse / 右ブレーキ	●●	FBC01
			freno sinistro / left brake / freno izquierdo / linke Bremse / 左ブレーキ	●●	FBC01
HUSQVARNA					
900 NUDA	12	15	freno ant. / front brake / freno delantero / vordere Bremse / フロント ブレーキ	●●●●●●	FBC04*

* necessita di due viti **005-M4x45** - Two bolts **005-M4x45** required - Necesita dos tornillos **005-M4x45**
 Erfordert zwei Schrauben **005-M4x45** - ボルト:品番005-M4x45が2個別途必要です。

COPERCHI POMPE FRENO E FRIZIONE - CLUTCH/BRAKE PUMP RESERVOIR COVERS

TAPAS BOMBA FRENO Y EMBRAGUE - BREMSPUMPEN UND KUPPLUNGSDECKEL - クラッチ・ブレーキ オイル リザーバー カバー

		Year		Article	Code	Price
		from	to			
KAWASAKI						
ER-6N		06	08	freno ant. / front brake / freno delantero / vordere Bremse / フロント ブレーキ	●●●●	FBC02
ER-6N		09	15	freno ant. / front brake / freno delantero / vordere Bremse / フロント ブレーキ	●●●	FBC16
Ninja 250 R		09	12	freno post. / rear brake / freno trasero / hintere Bremse / リア ブレーキ	●●●●●●	FBC06
Ninja 250 / 400		17	23	freno ant. / front brake / freno delantero / vordere Bremse / フロント ブレーキ	●●●●●●	FBC26
				freno post. / rear brake / freno trasero / hintere Bremse / リア ブレーキ	●●●●●●	FFC05
Ninja 650		21	22	freno ant. / front brake / freno delantero / vordere Bremse / フロント ブレーキ	●●●	FBC16
Z 400		17	23	freno ant. / front brake / freno delantero / vordere Bremse / フロント ブレーキ	●●●●●●	FBC26
				freno post. / rear brake / freno trasero / hintere Bremse / リア ブレーキ	●●●●●●	FFC05
Z650		17	22	freno ant. / front brake / freno delantero / vordere Bremse / フロント ブレーキ	●●●	FBC16
Z750 / Z1000		03	06	freno ant. / front brake / freno delantero / vordere Bremse / フロント ブレーキ	●●●●●	FBC02
Z750		07	12	freno ant. / front brake / freno delantero / vordere Bremse / フロント ブレーキ	●●●●●●	FBC06
Z750 R		11	12	freno ant. / front brake / freno delantero / vordere Bremse / フロント ブレーキ	●●●●	FBC19
Z800		13	16	freno ant. / front brake / freno delantero / vordere Bremse / フロント ブレーキ	●●●●	FBC16
				freno post. / rear brake / freno trasero / hintere Bremse / リア ブレーキ	●●●●●●	FFC05
Z900		17	24	freno ant. / front brake / freno delantero / vordere Bremse / フロント ブレーキ	●●●	FBC16
Z900 SE		22	24	freno ant. / front brake / freno delantero / vordere Bremse / フロント ブレーキ	●●●●●●	FBC06
Z1000		07	09	freno ant. / front brake / freno delantero / vordere Bremse / フロント ブレーキ	●●●●●●	FBC06
		10	18	freno ant. / front brake / freno delantero / vordere Bremse / フロント ブレーキ	●●●●	FBC19
Z1000SX		11	20	freno ant. / front brake / freno delantero / vordere Bremse / フロント ブレーキ	●●●●●●	FBC06
				freno post. / rear brake / freno trasero / hintere Bremse / リア ブレーキ	●●●●●●	FFC05
ZX 4 RR		24	24	freno ant. / front brake / freno delantero / vordere Bremse / フロント ブレーキ	●●●●●●	FBC16
				freno post. / rear brake / freno trasero / hintere Bremse / リア ブレーキ	●●●●●●	FFC05
ZX6R		07	08	freno ant. / front brake / freno delantero / vordere Bremse / フロント ブレーキ	●●●●●●	FBC06
				freno post. / rear brake / freno trasero / hintere Bremse / リア ブレーキ	●●●●●●	FFC05
ZX6R		09	15	freno ant. / front brake / freno delantero / vordere Bremse / フロント ブレーキ	●●●●●●	FBC06
				freno post. / rear brake / freno trasero / hintere Bremse / リア ブレーキ	●●●●●●	FBC23
ZX6R		16	23	freno ant. / front brake / freno delantero / vordere Bremse / フロント ブレーキ	●●●●●●	FBC06
				freno post. / rear brake / freno trasero / hintere Bremse / リア ブレーキ	●●●●●●	FFC05
ZX10R		08	15	freno ant. / front brake / freno delantero / vordere Bremse / フロント ブレーキ	●●●●●●	FBC06
				freno post. / rear brake / freno trasero / hintere Bremse / リア ブレーキ	●●●●●●	FFC05
ZX10R		16	20	freno ant. / front brake / freno delantero / vordere Bremse / フロント ブレーキ	●●●●●●	FBC04
				freno post. / rear brake / freno trasero / hintere Bremse / リア ブレーキ	●●●●●●	FFC05
ZX10R		21	24	freno ant. / front brake / freno delantero / vordere Bremse / フロント ブレーキ	●●●●●●	FBC04
				freno post. / rear brake / freno trasero / hintere Bremse / リア ブレーキ	●●●●	FBC32
KTM						
Duke 790		18	24	freno ant. / front brake / freno delantero / vordere Bremse / フロント ブレーキ	●	FBC30
Duke 890 R		21	23	freno ant. / front brake / freno delantero / vordere Bremse / フロント ブレーキ	●	FBC30
RC8 1190		08	12	freno ant. / front brake / freno delantero / vordere Bremse / フロント ブレーキ	●●●●●●	FBC06
990 Super Duke		07	12	freno ant. / front brake / freno delantero / vordere Bremse / フロント ブレーキ	●●●●●●	FBC04
				freno post. / rear brake / freno trasero / hintere Bremse / リア ブレーキ	●●	FFC03
690 SM / SMR		07	12	freno ant. / front brake / freno delantero / vordere Bremse / フロント ブレーキ	●●	FFC04
				freno post. / rear brake / freno trasero / hintere Bremse / リア ブレーキ	●●	FFC03
1290 Super Duke R		20	23	freno ant. / front brake / freno delantero / vordere Bremse / フロント ブレーキ	●●●	FBC04
				frizione / clutch / embrague / Kupplung / クラッチ	●●	FBC31
MV AGUSTA						
B3 675 / 800		12	17	freno ant. / front brake / freno delantero / vordere Bremse / フロント ブレーキ	●●●●●●	FBC03
Dragster		15	17	freno ant. / front brake / freno delantero / vordere Bremse / フロント ブレーキ	●●●●●●	FBC03
F3 675 / 800		12	17	freno ant. / front brake / freno delantero / vordere Bremse / フロント ブレーキ	●●●●●●	FBC06
Brutale		05	17	freno ant. / front brake / freno delantero / vordere Bremse / フロント ブレーキ	●●●●●●	FBC03
				frizione / clutch / embrague / Kupplung / クラッチ	●●●●●●	FFC01
F4		00	09	freno ant. / front brake / freno delantero / vordere Bremse / フロント ブレーキ	●●●●●●	FB003
				frizione / clutch / embrague / Kupplung / クラッチ	●●●●●●	FFC01
F4		14	17	freno ant. / front brake / freno delantero / vordere Bremse / フロント ブレーキ	●●●●●●	FBC04
				frizione / clutch / embrague / Kupplung / クラッチ	●●	FFC03
Rivale 800		14	17	freno ant. / front brake / freno delantero / vordere Bremse / フロント ブレーキ	●●●●●●	FBC03

Year		Article	Code	Price		
from	to					
SUZUKI						
Gladius 650	09	15	freno ant. / front brake / freno delantero / vordere Bremse / フロント ブレーキ	●●●●●●	FBC13	
GSR 600	06	12	freno ant. / front brake / freno delantero / vordere Bremse / フロント ブレーキ	●●●●●●	FBC13	
GSR 750	11	16	freno ant. / front brake / freno delantero / vordere Bremse / フロント ブレーキ	●●●●●●	FBC13	
GSXR 600 / 750	04	10	freno ant. / front brake / freno delantero / vordere Bremse / フロント ブレーキ	●●●●●●●	FBC06	
GSXR 1000	05	06	freno ant. / front brake / freno delantero / vordere Bremse / フロント ブレーキ	●●●●●●●	FBC06	
GSXR 1000	07	08	freno ant. / front brake / freno delantero / vordere Bremse / フロント ブレーキ	●●●●●●●	FBC06	
			frizione / clutch / embrague / Kupplung / クラッチ	●●●●●	FFC05	
GSXR 1000	09	22	freno ant. / front brake / freno delantero / vordere Bremse / フロント ブレーキ	●●●●●●●	FBC06	
GSX-S 750	17	21	freno ant. / front brake / freno delantero / vordere Bremse / フロント ブレーキ	●●●●●●	FBC13	
GSX-S 1000	15	23	freno ant. / front brake / freno delantero / vordere Bremse / フロント ブレーキ	●●●●●●	FBC24	
Katana	19	23	freno ant. / front brake / freno delantero / vordere Bremse / フロント ブレーキ	●●●●●●	FBC24	
TRIUMPH						
Daytona 675 / 675 R	07	16	freno ant. / front brake / freno delantero / vordere Bremse / フロント ブレーキ	●●●●●●●	FBC06	
			freno post. / rear brake / freno trasero / hintere Bremse / リア ブレーキ	●●●●●●	FFC05	
Speed Triple 1050	12	18	freno ant. / front brake / freno delantero / vordere Bremse / フロント ブレーキ	●●●●●●●	FBC04	
			freno post. / rear brake / freno trasero / hintere Bremse / リア ブレーキ	●●●●●●	FFC05	
Speed Triple RS 1200	21	24	freno ant. / front brake / freno delantero / vordere Bremse / フロント ブレーキ	●●●●●●●	FBC04	
Street Triple 675 / 675 R	07	16	freno post. / rear brake / freno trasero / hintere Bremse / リア ブレーキ	●●●●●●	FFC05	
Street Triple 765 R	17	24	freno ant. / front brake / freno delantero / vordere Bremse / フロント ブレーキ	●●●●●●●	FBC04	
			freno post. / rear brake / freno trasero / hintere Bremse / リア ブレーキ	●●●●●●	FFC05	
YAMAHA						
Fazer 1000	01	05	freno ant. / front brake / freno delantero / vordere Bremse / フロント ブレーキ	●●●●	FBC02	
FZ1	06	15	freno ant. / front brake / freno delantero / vordere Bremse / フロント ブレーキ	●●●●●●	FBC11	
FZ8	10	15	freno ant. / front brake / freno delantero / vordere Bremse / フロント ブレーキ	●●●●●●	FBC11	
FZ6	04	06	freno ant. / front brake / freno delantero / vordere Bremse / フロント ブレーキ	●●●●●●	FBC11	
MT-03	06	13	freno ant. / front brake / freno delantero / vordere Bremse / フロント ブレーキ	●●●●●●	FBC11	
			freno post. / rear brake / freno trasero / hintere Bremse / リア ブレーキ	●●●●●●	FFC05	
MT-07 / Tracer / Tracer 7 / Tracer 7 GT	14	24	freno ant. / front brake / freno delantero / vordere Bremse / フロント ブレーキ	●●●●	FBC02	
			freno post. / rear brake / freno trasero / hintere Bremse / リア ブレーキ	●●●●●●	FFC05	
MT-09 / Tracer	13	20	freno ant. / front brake / freno delantero / vordere Bremse / フロント ブレーキ	●●●●●●	FBC11	
			freno post. / rear brake / freno trasero / hintere Bremse / リア ブレーキ	●●●●●●	FFC05	
MT-09 / SP / Tracer 9 / Tracer 9 GT	21	24	freno ant. / front brake / freno delantero / vordere Bremse / フロント ブレーキ	●●●●●●	FBC06	
			freno ant. / front brake / freno delantero / vordere Bremse / フロント ブレーキ	●●●●●●●	FFC05	
R1	04	24	freno ant. / front brake / freno delantero / vordere Bremse / フロント ブレーキ	●●●●●●●	FBC06	
R1 / R1M	15	24	freno post. / rear brake / freno trasero / hintere Bremse / リア ブレーキ	●●●●●●	FBC23	
R6	03	05	freno ant. / front brake / freno delantero / vordere Bremse / フロント ブレーキ	●●●●●●●	FBC06	
R6	06	23	freno ant. / front brake / freno delantero / vordere Bremse / フロント ブレーキ	●●●●●●●	FBC06	
			freno post. / rear brake / freno trasero / hintere Bremse / リア ブレーキ	●●●●●●	FFC05	
R7	22	24	freno ant. / front brake / freno delantero / vordere Bremse / フロント ブレーキ	●●●●●●●	FBC06	
			freno post. / rear brake / freno trasero / hintere Bremse / リア ブレーキ	●●●●●●	FFC05	
T-Max 500 / 530 / 560	04	24	freno ant. / front brake / freno delantero / vordere Bremse / フロント ブレーキ	●●●●●	FBC15	
			freno post. / rear brake / freno trasero / hintere Bremse / リア ブレーキ	●●●●●	FBC15	
XJ6	08	15	freno ant. / front brake / freno delantero / vordere Bremse / フロント ブレーキ	●●●●●●	FBC11	



FBC18



FBC25



FBC26



FBC29



A close-up photograph of a KTM motorcycle's engine and frame. The frame is painted in a vibrant orange color with white and grey graphics. The engine is black with a grey protective cover that has the 'KTM' logo in white. A black protective cap with an orange ring and the 'Lighttech' logo is mounted on the engine. The background is dark, making the orange and black of the motorcycle stand out.

PROTEZIONI
PROTECTIONS
PROTECCIONES
PROTEKTOREN
プロテクション

PROTEZIONI TELAIO

FRAME SLIDERS - PROTECCIONES CARENADO - RAHMENPROTEKTOREN - フレーム スライダー

PATENTED®



Anello in alluminio
Aluminium ring
Anillo en aluminio
Aluminium Ring
アルミニウム リング

Available colours: ●



Boccola per oscillazione in magnesio
Magnesium bushing for oscillation
Casquillo para las oscilaciones en magnesio
Schraubenaufnahme in Magnesium
防振用 マグネシウム ブッシング

Available colours: ●



Guscio in Nylon
Nylon shell
Concha en Nylon
Protektor in Nylon
ナイロン シェル



Gommino antishock in TPE durezza 60 Shore
Antishock rubber made of TPE - hardness 60 Shore
Goma antishock en TPE dureza 60 shore
Wechselbare Vibrationsdämpfer, Härte 60 Shore
TPE硬度60-shore製アンチショックラバー

Available colours: ●



Fondo in magnesio
Magnesium bottom
Fondo en magnesio
Grundplatte in Magnesium
マグネシウム ボトム



Available colours: ●

! END STOCK 廃盤

Drill fairing	Year		Internal bush hole (ø mm)	Code	Pricee
	from	to			
APRILIA					
Dorsoduro 750 / 1200	/	08 17	10	STEAP201	
Dorsoduro 900	/	18 20	10	STEAP201	
RSV4 see page 168	/	09 14	-	STEAP104	
RSV4 see page 168	/	09 14	-	STEAP105	
RSV4 see page 168	/	15 20	-	STEAP107	
Shiver 750	/	07 16	10	STEAP201	
Shiver 900	/	18 20	10	STEAP201	
Tuono V4	/	11 20	10	STEAP203	
Tuono V4 see page 168	/	11 20	-	STEAP106	
Tuono V4 1100 Factory	/	21 23	10	STEAP204	
BENELLI					
Leoncino	/	18 21	10	STEBN201	
BMW					
R Nine-T Scrambler	/	16 19	-	STEBM207	
S1000RR	/	09 11	10	STEBM201	
S1000RR / HP4	/	12 14	10	STEBM205	
S1000RR	/	15 18	10	STEBM206	
S1000RR	/	19 22		STEBM208	
NEW S1000RR	/	23 24		STEBM209	

STEBM209
(S1000RR 2023-2024)



STEBM208
(S1000RR 2019-2022)



PROTEZIONI TELAIO

FRAME SLIDERS - PROTECCIONES CARENADO - RAHMENPROTEKTOREN - フレームスライダー

! END STOCK 廃盤

	Drill fairing	Year		Internal bush hole (ø mm)	Code	Pricee
		from	to			
DUCATI						
Hypermotard 796	/	09	12	10	STEDU205	
Hypermotard 821 / Hyperstrada 821	/	13	16	10	STEDU206	
Monster 696 / 796 / 1100	/	08	14	10	STEDU202	
Scrambler	/	14	16	10	STEDU207	
Streetfighter 848	/	11	16	10	STEDU205	
Streetfighter 1100	/	09	15	10	STEDU203	
HONDA						
CB 500 F	/	13	22	10	STEH0213	
CB 650 F	/	17	18	12	STEH0215	
CB 650 R	/	19	24	12	STEH0215	
NEW CB 750 Hornet	/	23	24	12	STEH0217	
CB 1000 R	/	08	22	12	STEH0211	
CBF 1000	/	06	12	12	STEH0211	
CBR 600 F	right / left	11	13	12	STEH0201	
CBR 600 RR	right / left	03	06	12	STEH0201	
CBR 600 RR	right / left	09	13	12	STEH0203	
CBR 1000 RR	/	06	07	10	STEH0208	
CBR 1000 RR	right / left	08	16	12	STEH0209	
CBR 1000 RR-R / SP	/	20	23	12	STEH0216	
Hornet 600	/	03	06	10	STEH0204	
Hornet 600	/	07	13	12	STEH0205	
HUSQVARNA						
Nuda 900	/	12	15	12	STEHU201	
KAWASAKI						
Ninja 650	/	21	24	10	STEKA218	
Z125	/	19	22	10	STEKA216	
NEW Z400	/	17	24	10	STEKA219	
Z650	/	17	21	10	STEKA214	
Z650	/	22	24	10	STEKA217	
Z750	/	04	06	10	STEKA205	
Z750	/	07	12	10	STEKA206	
Z800	/	13	16	-	STEKA112NER ●	
Z800	/	13	16	-	STEKA112SIL ●	
Z800	/	13	16	-	STEKA112ROS ●	
Z900	/	17	24	10	STEKA215	
Z1000	/	03	06	10	STEKA205	
Z1000	/	07	09	10	STEKA206	
Z1000	/	10	20	10	STEKA207	
ZX 4 RR	/	24	24	10	STEKA220	
ZX6R	right / left	05	06	10	STEKA202	
ZX6R	/	07	08	10	STEKA203	
ZX6R / 636	/	13	21	10	STEKA213	
ZX10R	left	08	10	10	STEKA204	
ZX10R	/	11	23	10	STEKA210	
KTM						
Duke 125	/	17	21	10	STEKT203	
Duke 390	/	17	22	10	STEKT203	
Duke 790	/	18	23	10	STEKT204	
Duke 890 / L / R	/	20	23	10	STEKT204	

! END STOCK 廢盤

	Drill fairing	Year		Internal bush hole (ø mm)	Code	Pricee
		from	to			
MOTO MORINI						
NEW Seiamezzo STR / SCR	/	23	24	10	STEMM201	
X-Cape	/	23	24	10	STEMM202	
MV						
Brutale 675 / 800	/	12	16	10	STEMV202	
Brutale 800	/	17	18	12	STEMV203	
Dragster 800	/	13	16	10	STEMV202	
Dragster 800	/	17	18	12	STEMV203	
Rivale 800	/	13	16	10	STEMV202	
SUZUKI						
Gladius 650	/	09	15	10	STESU209	
GSR 600	/	06	11	10	STESU208	
GSR 750	/	11	16	10	STESU211	
GSXR 600 / 750	/	08	10	10	STESU202	
GSXR 600 / 750	/	11	17	10	STESU210	
GSXR 1000	/	07	08	10	STESU205	
GSXR 1000	/	09	16	10	STESU206	
GSXR 1000	/	17	22	10	STESU215	
GSX-S 750	/	17	20	10	STESU214	
NEW GSX-8 S	/	23	24	12	STESU217	
GSX-S 950	/	21	22	10	STESU212	
GSX-S 1000	/	15	22	10	STESU212	
NEW GSX-S 1000 GT	/	16	23	10	STESU216	
Katana	/	20	22	10	STESU212	
SV 650	/	16	23	10	STESU213	
TRIUMPH						
Street Triple 675 / 675R	/	07	10	10	STETR203	
Street Triple 675 / 675R	/	11	16	10	STETR205	
Street Triple 765 / 765R / 765RS	/	17	24	10	STETR205	
Speed Triple 1050	/	08	10	12	STETR202	
Speed Triple 1050	/	11	16	12	STETR204	
Speed Triple RS 1200	/	21	24	10	STETR206	
YAMAHA						
Fazer 600 / FZ6	/	04	12	10	STEYA205	
FZ1	/	06	15	10	STEYA206	
FZ8	/	10	15	10	STEYA206	
MT-03	/	06	14	10	STEYA208	
MT-03 (cc 300)	/	15	23	10	STEYA217	
MT-07	/	14	23	10	STEYA212	
NEW Tracer 7 / Tracer 7 GT	/	20	24	12	STEYA220	
MT-09	/	13	16	10	STEYA211	
MT-09 / SP	/	17	20	10	STEYA215	
MT-09 / SP / Tracer 9 / Tracer 9 GT	/	21	24	10	STEYA218	
MT-09 Tracer / XSR 900	/	13	22	10	STEYA211	
MT-10	/	16	23	12	STEYA213	
R1 / R1-M	/	15	24	12	STEYA213	
R3	/	15	18	10	STEYA214	
R6	/	06	07	10	STEYA203	
R6	/	08	16	10	STEYA204	
R6	/	17	23	10	STEYA216	
NEW R7	/	22	24	12	STEYA219	

PROTEZIONI TELAIO

FRAME SLIDERS - PROTECCIONES CARENADO - RAHMENPROTEKTOREN - フレームスライダー



Controllare posizione vite
Check bolt position
Controlar posición tornillo
Position der Schraube überprüfen
ボルトの位置をご確認ください



	APRILIA RSV4			APRILIA TUONO V4
	<p>Code: STEAP104</p> <p>Upper position</p> 	<p>Code: STEAP105</p> <p>Central position</p> 	<p>Code: STEAP107</p> <p>Lower position</p> 	<p>Code: STEAP106</p> <p>Central position</p> 



Anelli in alluminio

Aluminium rings - Anillos en aluminio - Aluminium Ringe - のアルミニウムリング



	RSTE102ARA	<input type="checkbox"/>
	RSTE102ROS	<input type="checkbox"/>
	RSTE102ORO	<input type="checkbox"/>
	RSTE102VER	<input type="checkbox"/>
	RSTE102COB	<input type="checkbox"/>
	RSTE102NER	<input type="checkbox"/>
	RSTE102SIL	<input type="checkbox"/>

Gommino shock absorber

Shock absorber rubber - Silemblock de goma - Gummishockabsorber für Rahmenprotektoren - ラバーショックアブソーバー



RSTE101ARA	RSTE101BLU	RSTE101ROS	RSTE101VER	RSTE101NER	RSTE101BIA	<input type="checkbox"/>
------------	------------	------------	------------	------------	------------	--------------------------

Ricambi protezioni telaio

Frame slider spare parts - Recambio proteccion carenado - Ersatzteile für Protektoren - フレームスライダー

Ø10	RSTE210BIA RSTE210NER	<input type="checkbox"/>
Ø12	RSTE212BIA RSTE212NER	<input type="checkbox"/>



RSTE__BIA



RSTE__NER



BORN
TO BE
MOTO





PROTEZIONI PERNI RUOTA
WHEEL AXLE SLIDERS
PROTECCIONES TUERCA RUEDA
RADACHSE PROTEKTOREN
ホイール アクスル スライダー

PROTEZIONI PERNI RUOTA

WHEEL AXLE SLIDERS - PROTECCIONES TUERCA RUEDA - RADACHSE PROTEKTOREN - ホイール アクスル スライダー

Evoluzione delle linee
Evolution of the lines
Evolución de las líneas
Entwicklung des Design
ラインナップの進化



SMART PLUG INSERT

Combinazioni colori dedicate
Dedicated color combinations
Combinaciones de colores específicas
Spezielle Farbkombinationen
豊富なカラーコンビネーション

Maggior protezione agli urti
Greater impact protection
Mayor protección ante los robos
Höher Aufprallschutz
さらに衝撃に強いプロテクション

Ricambio interno

Replacement internal part - Recambio interior - Innere Ersatzteile - 内部スペアパーツ



			for piece
		KWAP001ARA	<input type="text"/>
		KWAP001ROS	<input type="text"/>
		KWAP001ORO	<input type="text"/>
		KWAP001VER	<input type="text"/>
		KWAP001COB	<input type="text"/>
		KWAP001NER	<input type="text"/>
		KWAP001SIL	<input type="text"/>



		Year		Code	Price	Front / Rear
		from	to			
APRILIA						
Dorsoduro 750 / 1200	●●●●●	08	17	WAPAP401		F+R
Dorsoduro 900	●●●●●	18	21	WAPAP401		F+R
RS 660 / Tuono 660	●●●●●	20	24	WAPAP402		F+R
RSV4 R / Factory / APRC	●●●●●	09	21	WAPAP401		F+R
RSV4 1100 Factory	●●●●●	22	24	WAPAP403		F+R
Shiver 750	●●●●●	07	16	WAPAP401		F+R
Tuono V4	●●●●●	11	21	WAPAP401		F+R
Tuono V4 / Factory	●●●●●	22	24	WAPAP403		F+R
BMW						
S1000 R	●●●●●	14	24	WAPBM401		F+R
S1000 RR	●●●●●	09	24	WAPBM401		F+R
S1000 XR	●●●●●	17	19	WAPBM402		F+R
S1000 XR	●●●●●	20	24	WAPBM403		F+R
DUCATI						
Diavel	●●●●●	11	17	WAPDU401		F
Hypermotard 821 / 939 / 959 / 950	●●●●●	13	22	WAPDU403		F
Monster 821	●●●●●	14	16	WAPDU405		F+R
Monster 937	●●●●●	21	24			
Monster 1100	●●●●●	11	13	WAPDU402		F
Monster 1200 / S / R	●●●●●	14	21	WAPDU403		F
Multistrada 950 / S	●●●●●	19	21	WAPDU405		F+R
Multistrada V2 / S	●●●●●	22	22	WAPDU405		F+R
Multistrada V4 / S	●●●●●	21	24	WAPDU405		F+R
Panigale 959	●●●●●	15	19	WAPDU408		F+R
Panigale 1199	●●●●●	12	14	WAPDU401		F
				ARDU110		R
Panigale 1299	●●●●●	15	17	WAPDU409		F
				ARDU110		R
Panigale 955 V2	●●●●●	21	24	WAPDU409		F
				ARDU110		R
Panigale V4 / S	●●●●●	18	24	WAPDU409		F
				ARDU110		R
Streetfighter 848	●●●●●	11	16	WAPDU402		F
Streetfighter 1100	●●●●●	09	15	WAPDU403		F
Streetfighter V4 / S	●●●●●	20	24	WAPDU409		F
				ARDU110		R
HONDA						
CB 650 F	●●●●●	14	15	WAPH0404		F
CB 1000 R	●●●●●	18	21	WAPH0407		F
CBR 600 RR	●●●●●	07	12	WAPH0401		F+R
CBR 600 RR	●●●●●	13	13	WAPH0403		F+R
CBR 600 RR	●●●●●	14	16	WAPH0401		F+R
CBR 1000 RR	●●●●●	08	16	WAPH0402		F+R
CBR 1000 RR	●●●●●	17	19	WAPH0405		F+R
CBR 1000 RR-R / SP	●●●●●	20	23	WAPH0405		F+R
XADV	●●●●●	17	24	WAPH0406		F+R
KAWASAKI						
Ninja 1000 SX	●●●●●	21	22	WAPKA406		F
Z650	●●●●●	17	24	WAPKA407		F+R
Z 800	●●●●●	13	16	WAPKA406		F
Z900	●●●●●	17	24	WAPKA408		F+R
Z 1000 - SX	●●●●●	14	20	WAPKA406		F
ZX6R / 636	●●●●●	13	21	WAPKA405		F+R
ZX10R	●●●●●	11	15	WAPKA401		F+R
ZX10R	●●●●●	16	23	WAPKA409		F+R

PROTEZIONI PERNI RUOTA

WHEEL AXLE SLIDERS - PROTECCIONES TUERCA RUEDA - RADACHSE PROTEKTOREN - ホイール アクスル スライダー

		Year		Code	Price	Front / Rear
		from	to			
KTM						
Duke 790	● ● ●	18	23	WAPKT402		F+R
Duke 890 R	● ● ●	20	23	WAPKT402		F+R
Super Duke 1290	● ● ●	17	22	WAPKT401		F
Super Duke 1290 / R	● ● ●	17	22	WAPKT403		R
MV AGUSTA						
Brutale	● ● ●	10	16	WAPMV401		F
				ARMV102		R
B3 675 / B3 800	● ● ●	12	16	WAPMV401		F
				ARMV102		R
F3 675 / F3 800	● ● ●	12	16	WAPMV401		F
				ARMV102		R
F4	● ● ●	10	16	WAPMV401		F
				ARMV102		R
Rivale 800	● ● ●	14	16	WAPMV401		F
				ARMV102		R
SUZUKI						
GSXR 600 / 750	● ● ● ● ●	06	10	WAPSU401		F+R
GSXR 600 / 750	● ● ● ● ●	11	17	WAPSU402		F+R
GSXR 1000	● ● ● ● ●	07	11	WAPSU401		F+R
GSXR 1000	● ● ● ● ●	12	22	WAPSU405		F+R
GSX-S 750	● ● ● ● ●	17	21	WAPSU406		F+R
GSX-8 R	● ● ● ● ●	24	24	WAPSU407		F+R
GSX-8 S	● ● ● ● ●	23	24	WAPSU407		F+R
GSX-S 1000	● ● ● ● ●	15	22	WAPSU404		F+R
TRIUMPH						
Daytona 675 / 675R	● ● ● ● ●	13	13	WAPTR401		F+R
Speed Triple RS 1200	● ● ● ● ●	21	23	WAPTR403		F
Street Triple 675 / 675R / RS	● ● ● ● ●	13	16	WAPTR401		F+R
Street Triple 765 S / 765R / RS	● ● ● ● ●	17	23	WAPTR402		F
YAMAHA						
MT-07	● ● ● ● ●	14	22	WAPYA403		F
				ARYA104		R
Tracer 7 / Tracer 7 GT	● ● ● ● ●	20	23	WAPYA416		F
MT-09 / Tracer / XSR900	● ● ● ● ●	13	16	WAPYA402		F+R
MT-09 / SP / Tracer / Tracer GT / XSR900	● ● ● ● ●	17	20	WAPYA410		F+R
MT-09 / SP / Tracer 9 / Tracer 9 GT	● ● ● ● ●	21	24	WAPYA415		F+R
MT-10	● ● ● ● ●	16	23	WAPYA411		F+R
R1	● ● ● ● ●	07	14	WAPYA401		F+R
R1 / R1M	● ● ● ● ●	15	24	WAPYA411		F+R
R3	● ● ● ● ●	15	24	WAPYA413*		F+R
R6	● ● ● ● ●	06	16	WAPYA401		F+R
R6	● ● ● ● ●	17	22	WAPYA411		F+R
R7	● ● ● ● ●	22	24	WAPYA414		F
				ARYA104		R
T-Max 500	● ● ● ● ●	08	11	WAPYA412		F
T-Max 530	● ● ● ● ●	12	14	WAPYA405		F+R
T-Max 530 / 560	● ● ● ● ●	15	24	WAPYA409		F+R

NEW

WAPYA413*





LightTech
made in Italy

PROTEZIONI IN ALLUMINIO
ALUMINIUM PROTECTIONS
PROCTECTOR DE ALUMINIO
ALUMINIUM PROTEKTOREN
アルミニウム プロテクション

APRILIA



ECPAP005

RSV4 R / RR / FACTORY / APRC / RF Year: 09-20

TUONO R / RR / FACTORY / APRC / RF Year: 11-20

ECPAP001

RSV4 1100 FACTORY Year: 21-24

TUONO 1100 FACTORY Year: 21-24

ECPAP005

Copri Alternatore lato L
Electric Cover L Side
Tapa Alternador lado L
Lichtmaschine Deckel Seite L
ジェネレーターカバー 左側



RSV4 R / RR / FACTORY / APRC / RF Year: 09-20

RSV4 1100 FACTORY Year: 21-24

TUONO R / RR / FACTORY / APRC / RF Year: 11-20

TUONO 1100 FACTORY Year: 21-24

Copri Frizione lato R
Clutch Cover R Side
Tapa Embrague lado R
Kupplungs - Deckel Seite R
クラッチカバー 右側

ECPAP002

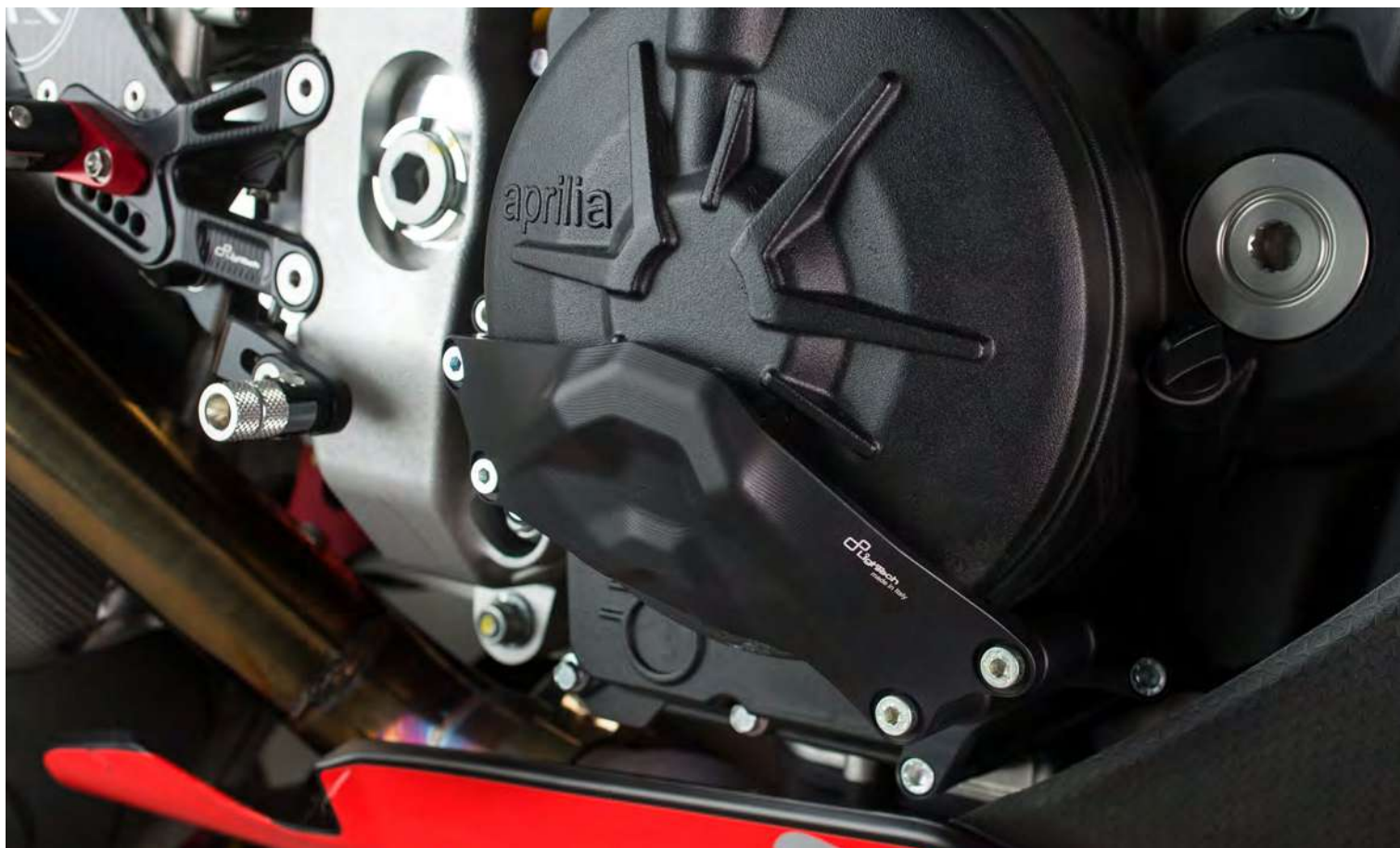



RS 660 Year: 20-24

Copri Frizione lato R
Clutch Cover R Side
Tapa Embrague lado R
Kupplungs - Deckel Seite R
クラッチカバー 右側

ECPAP003



RS 660 Year: 20-24

Copri Alternatore lato L
Electric Cover L Side
Tapa Alternador lado L
Lichtmaschine Deckel Seite L
ジェネレーターカバー 左側

ECPAP004

BMW



S 1000 R Year: 09-20

S 1000 RR Year: 09-18

Copri Alternatore lato L
Electric Cover L Side
Tapa Alternador lado L
Lichtmaschine Deckel Seite L
ジェネレーターカバー 左側

ECPBM001



S 1000 R Year: 21-24

S 1000 RR Year: 19-24

Copri Alternatore lato L
Electric Cover L Side
Tapa Alternador lado L
Lichtmaschine Deckel Seite L
ジェネレーターカバー 左側

ECPBM002





S 1000 R Year: 09-20
S 1000 RR Year: 09-18

Copri Pick Up lato R
Pick Up Cover R Side
Tapa Pick Up lado R
Pick Up Deckel Seite R
ビックアップカバー 右側

ECPBM003



S 1000 R Year: 21-24
S 1000 RR Year: 19-24

Copri Frizione / Pick Up
Clutch Cover / Pick Up
Tapa Embrague / Pick Up
Kupplungs-Deckel / Pick Up
クラッチカバ / ビックアップカバ

ECPBM004

PROTEZIONE CARTER

CARTER PROTECTOR - PROTECCIÓN DE CARTER - CARTER ABDECKUNG - カーター プロテクション

DUCATI



PANIGALE 1199 Year: 12-15

Copri Alternatore lato L
Electric Cover L Side
Tapa Alternador lado L
Lichtmaschine Deckel Seite L
ジェネレーターカバー 左側

ECPDU001



PANIGALE 1199 Year: 12-15

Copri Frizione lato R
Clutch Cover R Side
Tapa Embrague lado R
Kupplungs - Deckel Seite R
クラッチカバー 右側

ECPDU002



848 / 1098 / 1198 SBK Year: 07-11

HYPERMOTARD 796 / 1100 Year: 07-12

HYPERMOTARD 821 / HYPERSTRADA 821 Year: 13-16

MONSTER 1200 Year: 13-16

MULTISTRADA 1200 Year: 07-14

STREETFIGHTER 848 / 1100 Year: 09-16

Copri Pompa Acqua
Water Pump Cover
Cubre bomba agua
Wasserpumpenabdeckung
ウォーターポンプカバー

WPPDU002



HYPERMOTARD 939 / 950 Year: 17-23

MONSTER 821 Year: 14-20

MONSTER 1200 Year: 17-21

MULTISTRADA 950 / S Year: 19-21

MULTISTRADA 1200 Year: 15-19

Copri Pompa Acqua
Water Pump Cover
Cubre bomba agua
Wasserpumpenabdeckung
ウォーターポンプカバー

WPPDU003



PANIGALE V4 Year: 18-24

ECPDU006



PANIGALE V4 Year: 18-24
STREETFIGHTER V4 Year: 20-24

Copri Alternatore lato L
Electric Cover L Side
Tapa Alternador lado L
Lichtmaschine Deckel Seite L
ジェネレーターカバー 左側

ECPDU007



PANIGALE V2 Year: 21-24

Copri Alternatore lato L
Electric Cover L Side
Tapa Alternador lado L
Lichtmaschine Deckel Seite L
ジェネレーターカバー 左側

ECPDU008



PANIGALE V2 Year: 21-24

Copri Frizione lato R
Clutch Cover R Side
Tapa Embrague lado R
Kupplungs - Deckel Seite R
クラッチカバー 右側

ECPDU002

PROTEZIONE CARTER

CARTER PROTECTOR - PROTECCIÓN DE CARTER - CARTER ABDECKUNG - カーター プロテクション

HONDA



CBR1000 RR-R / SP Year: 20-24

Copri Frizione / Pick Up lato R
Clutch Cover / Pick Up Cover R Side
Tapa Embrague / Tapa Pick Up lado R
Kupplungs - Deckel / Pick Up Deckel Seite R
ピックアップ カバ / クラッチ カバー 右側

ECPH0006



CBR1000 RR-R / SP Year: 20-24

Copri Alternatore lato L
Electric Cover L Side
Tapa Alternador lado L
Lichtmaschine Deckel Seite L
ジェネレーター カバー 左側

ECPH0007



KAWASAKI



ZX 10R Year: 11-24

Copri Pick Up lato R
 Pick Up Cover R Side
 Tapa Pick Up lado R
 Pick Up Deckel Seite R
 ビックアップカバー 右側

ECPKA001



ZX 10R Year: 11-24

Copri Alternatore lato L
 Electric Cover L Side
 Tapa Alternador lado L
 Lichtmaschine Deckel Seite L
 ジェネレーターカバー 左側

ECPKA002



NINJA 300 Year: 13-17

Copri Frizione lato R
 Clutch Cover R Side
 Tapa Embrague lado R
 Kupplungs - Deckel Seite R
 クラッチカバー 右側

ECPKA003



NINJA 300 Year: 13-17

Copri Alternatore lato L
 Electric Cover L Side
 Tapa Alternador lado L
 Lichtmaschine Deckel Seite L
 ジェネレーターカバー 左側

ECPKA004

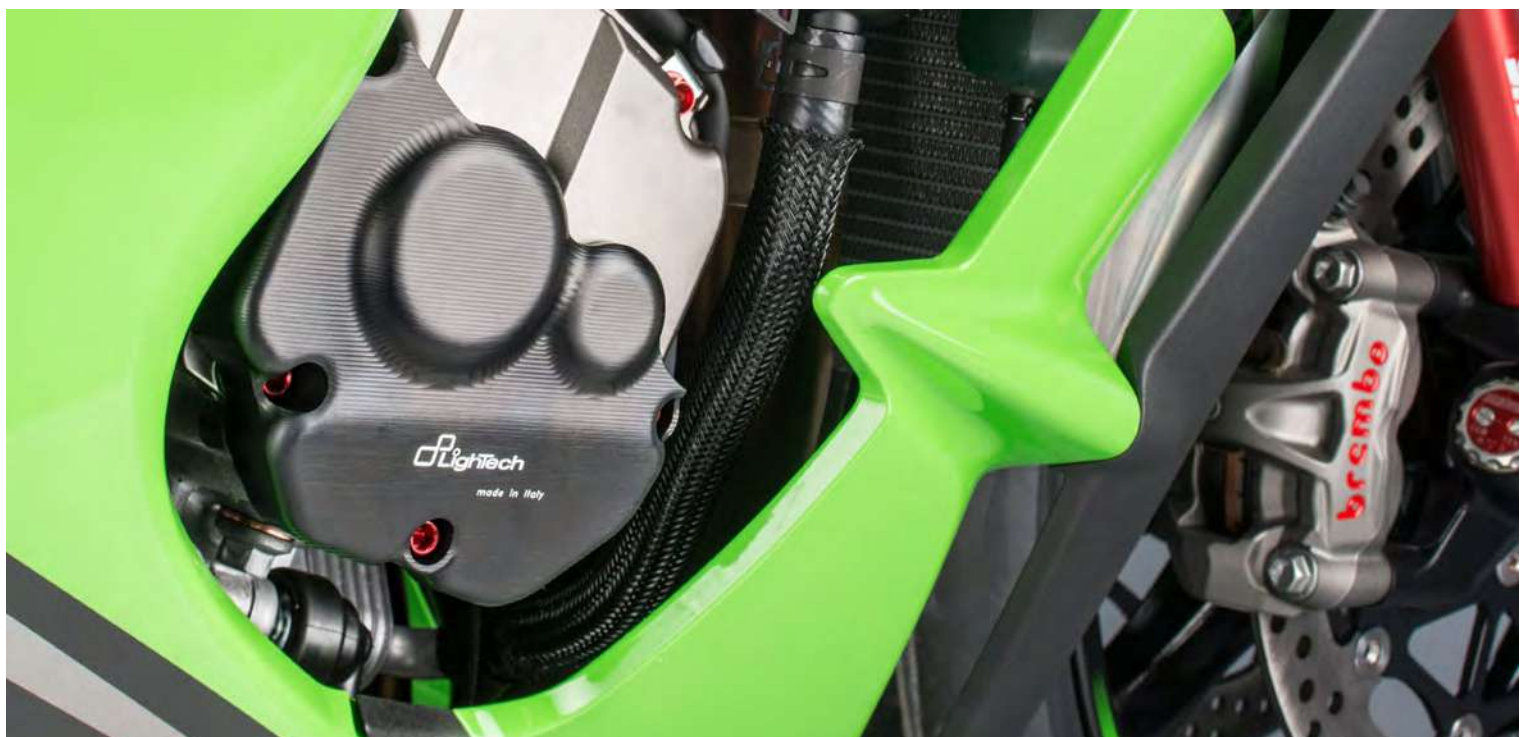

PROTEZIONE CARTER

CARTER PROTECTOR - PROTECCIÓN DE CARTER - CARTER ABDECKUNG - カーター プロテクション

MV AUGUSTA



B3 675 / 800 Year: 12-17

F3 675 / 800 Year: 12-17

DRAGSTER 800 Year: 14-17

RIVALE 800 Year: 14-17

Copri Alternatore lato L
Electric Cover L Side
Tapa Alternador lado L
Lichtmaschine Deckel Seite L
ジェネレーター カバー 左側

ECPMV003



B3 675 / 800 Year: 12-15

F3 675 / 800 Year: 12-15

DRAGSTER 800 Year: 14-15

RIVALE 800 Year: 14-15

Copri Frizione lato R
Clutch Cover R Side
Tapa Embrague lado R
Kupplungs - Deckel Seite R
クラッチ カバー 右側

ECPMV004

SUZUKI



GSXR 1000 Year: 17-22

Copri Alternatore lato L
Electric Cover L Side
Tapa Alternador lado L
Lichtmaschine Deckel Seite L
ジェネレーター カバー 左側

ECPSU006



YAMAHA



MT-10 Year: 16-21

R1 / R1M Year: 15-24

Copri Alternatore lato L
Electric Cover L Side
Tapa Alternador lado L
Lichtmaschine Deckel Seite L
ジェネレーターカバー 左側

ECPYA004



MT-10 Year: 16-21

R1 / R1M Year: 15-24

Copri Frizione lato R
Clutch Cover R Side
Tapa Embrague lado R
Kupplungs - Deckel Seite R
クラッチカバー 右側

ECPYA005



MT-10 Year: 16-21

R1 / R1M Year: 15-24

Copri Pick Up lato R
Pick Up Cover R Side
Tapa Pick Up lado R
Pick Up Deckel Seite R
ピックアップカバー 右側

ECPYA006



R6 Year: 06-23

Copri Alternatore lato L
Electric Cover L Side
Tapa Alternador lado L
Lichtmaschine Deckel Seite L
ジェネレーターカバー 左側

ECPYA001



R6 Year: 06-23

Copri Pick Up lato R
Pick Up Cover R Side
Tapa Pick Up lado R
Pick Up Deckel Seite R
ピックアップカバー 右側

ECPYA008



R6 Year: 06-23

Copri Frizione lato R
Clutch Cover R Side
Tapa Embrague lado R
Kupplungs - Deckel Seite R
クラッチカバー 右側

ECPYA009

PROTEZIONE CARTER

CARTER PROTECTOR - PROTECCIÓN DE CARTER - CARTER ABDECKUNG - カーター プロテクション

YAMAHA



R7 Year: 22-24

Copri Alternatore lato L
Electric Cover L Side
Tapa Alternador lado L
Lichtmaschine Deckel Seite L
ジェネレーターカバー 左側

ECPYA011



R7 Year: 22-24

Copri Frizione lato R
Clutch Cover R Side
Tapa Embrague lado R
Kupplungs - Deckel Seite R
クラッチカバー 右側

ECPYA012



T-MAX 500 - 530 Year: 06-16

Kit copri carter
Carter cover kit
Cubre carter kit
Carter-Abdeckung kit
クランクケースカバー

STEYA002

Available colours: ● ● ● ●

for pair



T-MAX 530 - 560 Year: 12-24

Kit copri carter perno forcellone
Swingarm pivot cover
Cubre perno basculante
Schutz für Schwingenbolzen
スイングアームピボットカバー

STEYA109

Available colours: ● ● ● ●

for pair



T-MAX 530 - 560 Year: 17-24

Kit copri carter
Carter cover kit
Cubre carter kit
Carter-Abdeckung kit
クランクケースカバー

ECPYA010

Available colours: ● ● ● ●

for pair



MT-09 / TRACER 9 / TRACER 9 GT Year: 21-24

Copri Alternatore lato L
 Electric Cover L Side
 Tapa Alternador lado L
 Lichtmaschine Deckel Seite L
 ジェネレーターカバー 左側

ECPYA013



MT-09 / TRACER 9 / TRACER 9 GT Year: 21-24

Copri Frizione lato R
 Clutch Cover R Side
 Tapa Embrague lado R
 Kupplungs - Deckel Seite R
 クラッチカバー 右側

ECPYA014



BORN
TO BE
MOTO



TAPPI SPECCHIO
MIRROR BLOCK-OFF PLATES
TAPÓNES ESPEJOS
SPIEGEL ABDECKUNG
ミラー ブラインド プレート



TAPPI SPECCHIO

MIRROR BLOCK-OFF PLATES - TAPÓNES ESPEJOS - SPIEGEL ABDECKUNG - ミラー ブラインド プレート

SPE129



APRILIA	Year		Code	Price
	for pair			
RS 660	20	24	● ●	SPE129
RSV4 (all versions)	09	24	● ●	SPE129

SPE101



SPE122



BMW	Year		Code	Price
	for pair			
S1000 RR	09	18	● ● ● ●	SPE101
S1000 RR	19	24	● ● ● ●	SPE122

SPE117



SPE121



SPE123



DUCATI	Year		Code	Price
	for pair			
Panigale 899 / 1199	12	15	● ●	SPE113
Panigale 1299	15	17	● ●	SPE117
Panigale 959	16	21	● ●	SPE117
Panigale V2	20	24	● ●	SPE123
Panigale V4 / S	18	19	● ●	SPE121
Panigale V4 / S	20	24	● ●	SPE123
Panigale V4 R	19	24	● ●	SPE123



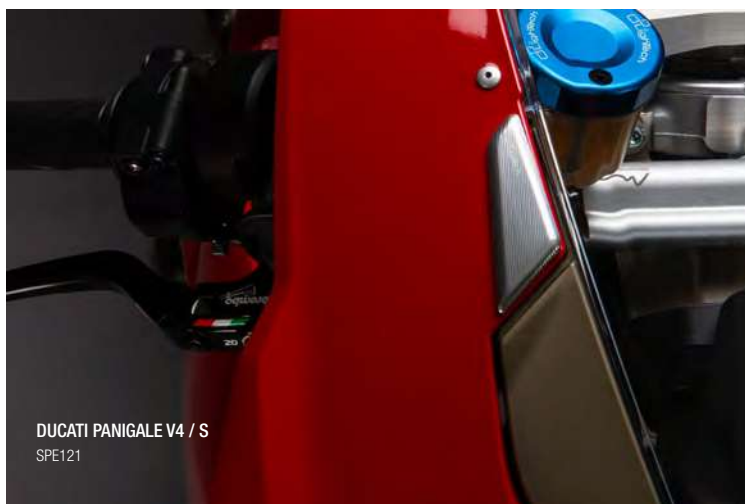

DUCATI PANIGALE V4 / S
SPE121



HONDA CBR 1000 RR-R
SPE125

SPE105



SPE125



HONDA	Year		Code	Price
CBR 500R	16	20	● ●	SPE102
CBR 600 RR	04	16	● ●	SPE105
CBR 1000 RR	04	07	● ●	SPE105
CBR 1000 RR / CBR 1000 RR-R / SP	08	24	● ●	SPE125

SPE102



SPE110



SPE112-118



SPE127



KAWASAKI	Year		Code	Price
ZX 4 RR	24	24	● ●	SPE112
ZX6R	05	08	● ●	SPE102
ZX6R	09	12	● ●	SPE110
ZX10R	04	07	● ●	SPE102
ZX10R	11	15	● ●	SPE112
ZX10R	21	23	● ●	SPE127

SPE114



MV AUGUSTA	Year		Code	Price
F3 675 / F3 800	12	20	● ●	SPE114

TAPPI SPECCHIO

MIRROR BLOCK-OFF PLATES - TAPÓNES ESPEJOS - SPIEGEL ABDECKUNG - ミラー ブラインド プレート

SPE103



SPE119



SUZUKI	Year			Code	Price
					for pair
GSXR 600 / 750 / 1000	05	16	● ● ●	SPE103	
GSXR 1000	17	23	● ● ● ●	SPE119	



SPE104



SPE120



SPE101



SPE115



SPEY08



SPE124



SPE126



SPE128



YAMAHA	Year			Code	Price
					for pair
R3	19	24	● ● ● ●	SPE126	
R6	99	07	● ● ●	SPE104	
R6	17	23	● ● ● ●	SPE120	
R7	22	24	● ● ● ●	SPE120	
R1	98	06	● ● ●	SPE104	
R1	07	14	● ● ● ●	SPE101	
R1 / R1M	15	19	● ● ●	SPE115	
R1 / R1M	20	24	● ● ●	SPE124	
T Max 530 - 560	12	21	● ● ● ●	SPEY08	
T Max 560	22	24	● ● ● ●	SPE128	



SPECCHI
MIRRORS
RETROVISORES
SPIEGEL
ミラー

SPECCHIETTI

MIRRORS - RETROVISORES - SPIEGEL - ミラー

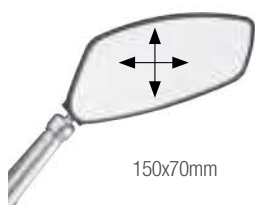

Coppia specchi alluminio (filetto 2xM10x1,25 Right + 1xM10x1,25 Left)
 Aluminium mirrors couple (thread 2xM10x1,25 Right + 1xM10x1,25 Left)
 Juego espejos en aluminio (rosca 2xM10x1,25 Right + 1xM10x1,25 Left)
 Aluminium Spiegel Paar (Gewinde das 2xM10x1,25 Right + 1xM10x1,25 Left)
 ペアミラー アルミニウム (ネジピッチ 2xM10x1,25 右 + 1xM10x1,25 左)

● SPEAL027NER

for pair



Coppia specchi alluminio (filetto 2xM10x1,25 Right + 1xM10x1,25 Left)
 Aluminium mirrors couple (thread 2xM10x1,25 Right + 1xM10x1,25 Left)
 Juego espejos en aluminio (rosca 2xM10x1,25 Right + 1xM10x1,25 Left)
 Aluminium Spiegel Paar (Gewinde das 2xM10x1,25 Right + 1xM10x1,25 Left)
 ペアミラー アルミニウム (ネジピッチ 2xM10x1,25 右 + 1xM10x1,25 左)

● SPEAL031NER

for pair



Coppia specchi alluminio (filetto 2xM10x1,25 Right + 1xM10x1,25 Left)
 Aluminium mirrors couple (thread 2xM10x1,25 Right + 1xM10x1,25 Left)
 Juego espejos en aluminio (rosca 2xM10x1,25 Right + 1xM10x1,25 Left)
 Aluminium Spiegel Paar (Gewinde das 2xM10x1,25 Right + 1xM10x1,25 Left)
 ペアミラー アルミニウム (ネジピッチ 2xM10x1,25 右 + 1xM10x1,25 左)

● SPEAL014NER
 ● SPEAL014ROS

for pair

Coppia specchi per T-MAX fissaggio a manubrio
 Pair of mirrors for T-MAX, fixing on handlebar
 Juego espejos para T-MAX, fijación en manillaros
 Spiegelpaar für T-MAX, am Lenker befestigt
 T-MAX用 アルミニウムミラーセット (ハンドルバー 装着用)

12 21

● SPEAL015NER
 ● SPEAL015ROS

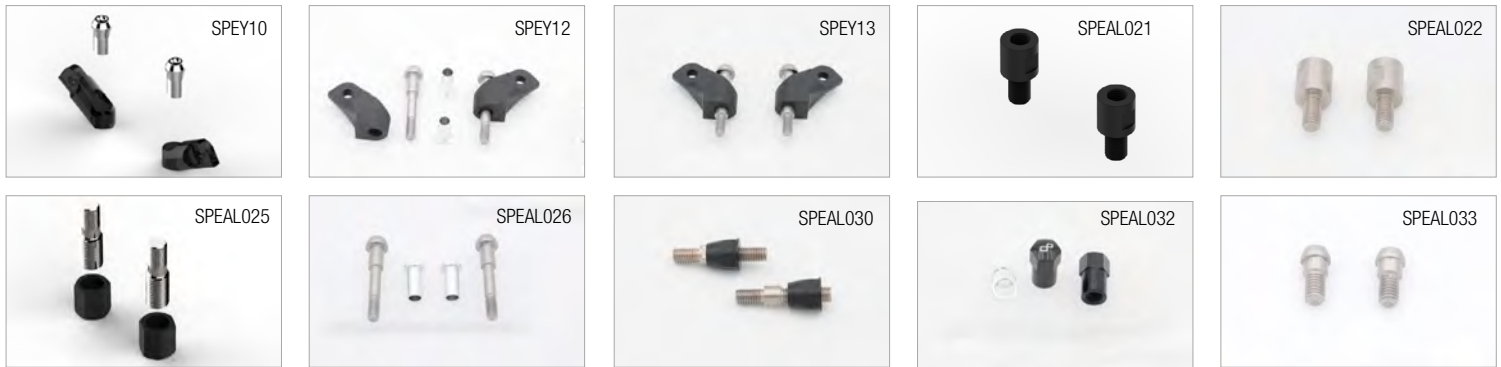

<p>Kit conversione attacchi specchio SPEAL015 T-Max (da manubrio a carena) in abbinamento con SPEY09 Conversion kit for T-Max mirrors SPEAL015 fitment (from handlebar to fairing) in combination with SPEY09 Kit de conversión espejo de T-Max SPEAL015 (Manillar a carenado) en combinación con SPEY09 Kit Anpassung Spiegeladapter T-Max SPEAL015 (von Lenker auf Verkleidung) in Kombination mit SPEY09 T-Max 用 SPEAL015 ミラー カウルマウント変換 アダプター (別途SPEY09が必要)</p>	● SPEY10	
<p>Kit conversione attacchi specchio (SPEAL015) per T-Max (da carena a manubrio) con leve originali Conversion kit mirror fitment (SPEAL015) for T-Max (from fairing to handlebar) with OEM levers Kit de conversión anclaje espejo (SPEAL015) para T-Max (de carenado a manillar) con manetas originales Änderungskit für Spiegelhalterung (SPEAL015) für T-Max (aus Verkleidung zum Lenker) mit originalen Hebeln T-MAX 用SPEAL015ミラーセット カウルマウント→ハンドルマウント変換アダプター (純正レバー装着時専用)</p>	● SPEY12	
<p>Kit conversione attacchi specchio (SPEAL015) per T-Max (da carena a manubrio) con leve Lightech Conversion kit mirror fitment (SPEAL015) for T-Max (from fairing to handlebar) with Lightech levers Kit de conversión anclaje espejo (SPEAL015) para T-Max (de carenado a manillar) con manetas Lightech Änderungskit für Spiegelhalterung (SPEAL015) für T-Max (aus Verkleidung zum Lenker) mit Lightech Hebeln T-MAX 用SPEAL015ミラーセット カウルマウント→ハンドルマウント変換アダプター (LIGHTTECH製レバー装着時専用)</p>	● SPEY13	
<p>Coppia adattatori specchio con filetto (da M10x1,25 femmina a M10 maschio L+R) Pair of mirror adaptors with thread (female M10x1.25 to male M10 left+right) Juego de adaptadores espejo con rosca (de M10X 1,25 Hembra a M10 macho L+R) Paar Spiegeladapter mit Gewinde (von M10x1,25 auf M10 / L+R) ミラーアダプターセット(M10x1.25⇒M10 / 右+左)</p>	● SPEAL021NER	
<p>Coppia adattatori specchio con filetto (da M10x1,25 femmina a M8 maschio L+R) Pair of mirror adaptors with thread (female M10x1.25 to male M8 L+R) Juego de adaptadores espejo con rosca (de M10X 1,25 Hembra a M8 macho L+R) Paar Spiegeladapter mit Gewinde (von M10x1,25 auf M8 / L+R) ミラーアダプターセット(M10x1.25⇒M8 / 右+左)</p>	● SPEAL022	
<p>Coppia adattatori specchio per BMW con filetto (da M10x1,5 a M8 / L+R) Pair of mirrors adaptors with thread (from M10x1,5 to M8 / L+R) for BMW Models Juego de adaptadores espejo para BMW con rosca (de M10 x1,50 a M8 / L+R) Paar Spiegeladapter mit Gewinde (von M10x1,5 auf M8 / L+R) für BMW ミラーアダプター BMW 用 (M10x1,5 ⇒ M8 / 右 + 左)</p>	● SPEAL025	
<p>Kit viti per montaggio specchi SPEAL015 su T-Max (con leve originali) Bolts kit for fitting SPEAL015 mirrors on T-Max (with OEM levers) Kit de tornillería para montaje de espejo SPEAL015 a la T-Max (con manetas originales) Schraubenkit für Montage Spiegel SPEAL015 auf T-Max (mit originalen Hebel) T-MAX 用 SPEAL015 ミラー フィッティング ボルトキット</p>	● SPEAL026	
<p>Coppia adattatori specchio per conversione da M8 DX a M8 (L+R) Pair of mirrors adaptors for conversion from M8 right to M8 (L+R) Juego de adaptadores espejo para conversión de M8 DX a M8 (L+R) Paar Spiegeladapter für Anpassung von M8 DX auf M8 (L+R) ミラーアダプターセット(M8右⇒M8 右+M8左)</p>	● SPEAL030	
<p>Coppia adattatori specchio per MV Agusta BRUTALE 4 CILINDRI Pair of mirror adaptors for MV Agusta BRUTALE 4 pistons Juego de adaptadores espejo para MV Agusta BRUTALE 4 CILINDROS Paar Spiegeladapter für MV Agusta Brutale 4 ZYLINDER ミラーアダプターセット MV AGUSTA BRUTALE 4気筒モデル専用</p>	● SPEAL032	
<p>Kit viti per specchi SPEAL014 con filetto M8 L+R Bolts kit for mirrors SPEAL014 with thread M8 L+R Kit tornillos espejos SPEAL014 con rosca M8 L+R Schraubenkit für Spiegel SPEAL014 mit Gewinde M8 L+R SPEAL014ミラーセット用ボルトキット (M10x1.25⇒M8 / 右+左)</p>	● SPEAL033	



VITERIA
BOLTS
TORNILLERIA
SCHRAUBEN
ボルト・スクリュー

M	A	B	C	D		
6	11,5	8,2	3,75	14	972	
6	15	9,85	5	22	974	
6	19	7,9	8	14	976	
6	30,5	8	23,5	14	977	
6	15	7,9	6	14	978	
6	13	6,9	4,4	14	979	
6	14	7,9	3,8	14	980	
5	15,6	7,9	2,6	14	981	
6	16	8,4	3,5	14	982	
6	15	7,9	6	17	983	
6	15	8,9	4	14	984	
6	30	6	11	12	991	
6	11	9,9	3,5	17	992	
5	10	8,9	3	14	993	
6	14,5	9,4	6	17	994	
6	14,5	11,9	3,5	17	995	
6	15	8,9	5	14	997	
6	15	9,9	3,5	17	998	
5	15	7	2,5	11,5	999	
6	15	9	2	14	1000	
5	20,5	7	13,5	12	1001	
5	20,5	6,9	2,5	12	1002	
6	11	8,2	4	14	1003	
6	14	7,9	5,5	14	1004	
6	15	9,8	5,5	22	1005	
10	40	10	5	16	1006	
6	20	6	1,5	30	1007	
6	25,5	8	13,5	17	1008	
5	25	-	-	9	1009	
6	21	10	8	17	1011	
6	21	8,25	13	17	1012	
6	25,5	8	10,5	24	1013	
5	16	8,2	8	14	1015	
6	16,5	8,5	3,5	17	1016	
6	16,5	8,2	5	12	1018	
6	20	9,8	8,6	17	1019	
5	17	8,2	5,8	14	1020	
6	20	8,7	9,2	14	1021	
5	12,8	8,1	3,7	14	1022	
5	11	8	2,6	14	1023	
6	-	-	-	-	1024	
					1027	
					1028	
5	-	-	-	10	1030	
5	17	7,4	5,5	12	1031	
5	20	7,4	9,5	12	1032	
8	25	11,9	10	19	1033	
6	16,5	8,6	3,5	17	1034	
6	20	8,5	10	17	1035	
5	13	8	-	12	1036	
5	17	8,5	6	12	1037	

	measure	Code	Price
Ganci rapidi in acciaio - Steel quick fairing fasteners - Tornillos rapidos en acero Schnellverschlusschrauben aus Stahl - ステンレス クイック フェアリング ファスナー	11 mm	GRSTTB11	
	12 mm	GRSTTB12	
	14 mm	GRSTTB14	

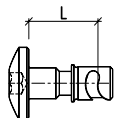

	measure	Code	Price
Ganci rapidi in ferro - Iron quick fairing fasteners - Tornillos rapidos en hierro Schnellverschlusschrauben aus Eisen - スチール クイック フェアリング ファスナー	11 mm	GRFE11	
	12 mm	GRFE12	
	14 mm	GRFE14	

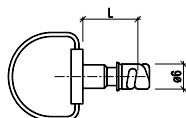

	Code	Price
Ricettacoli - Receptacle - Soporte tornillo rapido - Soporte tornillo rapido - クイック ファスナー クリップ		
	RIC	



	Code	Price
Cappelletto valvola ruota - Wheel valve cap - Tapón valvula rueda Radventildeckel - ホイールバルブキャップ		
	VAL	



Available colours:



7075 ERGAL BOLTS



Nm

Ergal 7075

M3	M4	M5	M6	M8	M10	M12	M14	M16
0,75	1,50	3,00	5,20	12,30	25,00	42,40	67,50	102,5



0011	M4	M5	M6	M8	M10 x 1,25	M10 x 1,5	M12 x 1,25
0012					M10 x 1		
0013							M12 x 1,5



0015	M4	M5	M6	M8



0016	M5	M6	M8



Standard

measure	ø ext.	thickness	Code
M4	9	0,8	RM4
M5	10	1,5	RM5
M6	12	1,6	RM6
M8	17	1,6	RM8
M10	21	2	RM10



Special

measure	ø ext.	thickness	Code
M5	17	1,6	RSM5A
M5	21	1,6	RSM5B
M6	17	1,6	RSM6A
M6	21	1,6	RSM6B
M8	21	2	RSM8A
M10	30	2	RSM10



measure	ø ext.	thickness	Code
M5	15	5	RCM5
M6	22	4	RCM6
M8	25	5,5	RCM8

5TH DEGREE TITANIUM BOLTS



Nm

TIT. 6AV4V G5

M3	M4	M5	M6	M8	M10	M12	M14	M16
1,73	3,57	6,90	11,10	28,30	57,60	97,50	155,20	235,70



T0015	M4	M5	M6	M8	M10 x 1,25	M10 x 1,5	M12 x 1,25



Standard

measure	ø ext.	thickness	Code
M4	9	0,8	RM4T
M5	10	1,5	RM5T
M6	12	1,6	RM6T
M8	17	1,6	RM8T
M10	21	2	RM10T



Special

measure	ø ext.	thickness	Code
M5	17	1,6	RSM5AT
M6	17	1,6	RSM6AT
M6	21	1,6	RSM6BT
M8	21	2	RSM8AT
M10	30	2	RSM10T

NYLON WASHERS



measure	ø ext.	thickness	Code
M4	10	0,5	RPM4
M5	12	0,5	RPM5
M6	14	0,5	RPM6
M8	16	0,5	RPM8

VITI DISCHI FRENO IN TITANIO GRADO - BOLTS FOR BRAKE DISK IN TITANIUM 5 DEGREE - TORNILLOS PARA DISCO FRENO EN TITANIO GRADO 5 - SPEZIALSCHRAUBEN FÜR BREMSSCHEIBEN AUS TITAN HÄRTEGRAD 5 - ブレーキ ディスク用 G5 チタン ボルト



I modelli di moto citati sono indicativi, pertanto si consiglia di verificare le misure delle viti.
 The motorbikes mentioned can be not correct, please control the measures.
 El Modelo de moto citado es solo indicativo, se recomienda verificar la medida del tornillo.
 Bei bestellen bitte Motorrad Modell und Maße der standard Schraube genau angeben.
 年式・モデルにより、サイズが異なる場合があります。
 必ず使用しているボルトの実寸を計測してください。

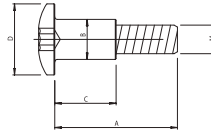

! END STOCK 廃盤

Bike	M	A	B	C	D	Code	Price
							for piece
KAWASAKI	8	31	10	5	18	VIT K	
SUZUKI	8	33	10	10	16	VIT S	
SUZUKI	8	21	9,9	6	16	VIT S2	
DUCATI	8	15	-	-	13	VIT D1	
HONDA ANT. / front	6	20	-	-	15	VIT H1	
HONDA POST. / rear	8	23	10	5	16	VIT H2	
HONDA CR. ANT. / front	6	20	-	-	12	VIT H3	
YAMAHA ANT. / front	6	21	8	6	14	VIT Y	
YAMAHA POST. / rear	8	20	9,8	4,5	16	VIT Y2	

Raccorderia freno - Brake parts

Tornilleria freno - Bremsanschlüsse - ブレーキ パーツ

! END STOCK 廃盤



	Measure	Code	Price
Bullone singolo - Single bolt Tornillo simple - Einzelschraube シングル バンジョー ボルト	M 10 X 1	VF11	
	M 10 X 1,25	VF1251	



	Measure	Code	Price
Bullone doppio - Double banjo bolt Tornillo doble - Doppelschraube ダブル バンジョー ボルト	M 10 X 1	VF12	
	M 10 X 1,25	VF1252	



	Measure	Code	Price
Bullone singolo con spurgo - Single banjo bolt with bleeder Tornillo simple con purgador - Einzelschraube mit Endlüfter シングル バンジョー ボルト ブリーダー付	M 10 X 1	VF11SP	
	M 10 X 1,25	VF1251SP	



	Measure	Code	Price
Bullone doppio con spurgo Double banjo bolt with bleeder Tornillo doble con purgador - Doppelschraube mit Endlüfter ダブル バンジョー ボルトブリーダー付	M 10 X 1	VF12SP	
	M 10 X 1,25	VF1252SP	



	Measure	Code	Price
Spurgo - Bleeder Purgador - Endlüfter ブリーダー	M6	SPM6	
	M7	SPM7	
	M8	SPM8	
	M 10 x 1	SPM10	



KIT VITI
BOLT KIT
KIT TORNILLERIA
SCHRAUBEN SET
ボルトキット

Available colours: ●●●●●● * Only for some Kawasaki models

	Years		ENGINE			FRAME			FAIRING		
	from	to	Pieces	Code	Price	Pieces	Code	Price	Pieces	Code	Price
APRILIA											
Dorsoduro 750	08	16	24	9AD M		29	9AD T		31	9AD C	
Dorsoduro 1200	11	16	26	1AD M		25	1AD T		36	1AD C	
RS 660	20	22	20	ENGAP001		9	FRMAP001		22	FARAP001	
RSV 1000 R	05	08	56	5A1 M		33	5A1 T		67	5A1 C	
RSV4 R / Factory / APRC / RF	09	20	30	9A4 M		22	9A4 T		44	9A4 C	
Shiver	07	12	38	7A7 M		27	7A7 T		42	7A7 C	
Tuono V4	11	20	34	1AT M		28	1AT T		42	1AT C	
BMW											
S 1000 R	14	16	38	4BS M		25	4BST		50	4BS C	
S 1000 R	17	20	-	-		-	-		50	4BS C	
S 1000 RR	09	14	38	0B1 M		23	0B1 T		66	0B1 C	
S 1000 RR	15	18	34	5B1 M		19	5B1 T		63	5B1 C	
S 1000 RR	19	22	19	9B1 M		14	9B1 T		23	9B1 C	
CF MOTO											
NK 650	21	22	32	ENGCF001		12	FRMCF001		14	FARCF001	
DUCATI											
848	08	12	24	8D8 M		16	8D8 T		77	8D8 C	
1098 - 1198	07	11	26	7D1M		20	7D1 T		73	7D1 C	
Diavel	11	16	35	2DD M		23	2DD T		42	2DD C	
DS 1200 Multistrada	10	12	34	0D1 M		23	0D1 T		76	0D1 C	
Hypermotard 1100	07	12	34	7DM M		24	7DM T		31	7DM C	
Hypermotard 821 / Hyperstrada	13	15	44	3DH M		21	3DH T		54	3DH C	
Monster 696	08	13	42	8D6 M		14	8D6 T		47	8D6 C	
Monster 821	14	17	48	4D8 M		12	4D8 T		41	4D8 C	
Monster 1100	11	13	39	1DM M		20	1DM T		38	1DM C	
Monster 1200 / R	17	20	41	1D7 M		12	1D7 T		42	1D7 C	
Panigale 1199 / 1199 R	12	14	24	2DP M		24	2DP T		62	2DP C	
Panigale 1299 / 1299 R	15	17	16	6D1 M		20	6D1 T		73	6D1 C	
Streetfighter 848	11	14	42	1D8 M		17	1D8 T		73	1D8 C	
Streetfighter 1100	09	14	47	9DS M		13	9DS T		70	9DS C	
HONDA											
CB 500 F	13	15	34	3H5 M		21	3H5 T		41	3H5 C	
CB 650 F	14	17	25	4H6 M		39	4H6 T		36	4H6 C	
NEW CB 750 Hornet	23	23	34	ENGH0001		7	FRMH0001		10	FARH0001	
CB 1000 R	08	17	25	8HB M		32	8HB T		31	8HB C	
CB 1000 R	18	21	30	1H8 M		24	1H8 T		29	1H8 C	
CBR 600 F	11	14	21	1H6 M		25	1H6 T		35	1H6 C	
CBR 250 RR	11	14	24	2H5 M		20	2H5 T		34	2H5 C	
CBR 600 RR	07	08	25	7H6 M		27	7H6 T		59	7H6 C	
CBR 600 RR	09	12	-	-		30	9HC T		63	9HC C	
CBR 600 RR	13	16	12	6H6 M		32	6H6 T		63	6H6 C	
CBR 1000 RR	06	07	30	6H1 M		24	6H1 T		68	6H1 C	
CBR 1000 RR	08	11	26	8H1 M		26	8H1 T		43	8H1 C	
CBR 1000 RR	12	14	17	2HB M		27	2HB T		48	2HB C	
CBR 1000 RR	17	19	24	1H7 M		28	1H7 T		36	1H7 C	
CRF 450	08	09	37	8H4 M		17	8H4 T		27	8H4 C	
CRF 450	10	11	39	0H4 M		6	0H4 T		38	0H4 C	
Hornet 600	07	10	26	7HH M		27	7HH T		34	7HH C	
Hornet 600	11	13	26	1HH M		25	1HH T		30	1HH C	
Integra 700	12	13	-	-		11	2H1 T		29	2H1 C	
NC 700 X	12	13	35	3H7 M		19	3H7 T		28	3H7 C	
XADV 750	17	20	-	-		18	7H7 T		24	7H7 C	

	Years		ENGINE			FRAME			FAIRING		
			Pieces	Code	Price	Pieces	Code	Price	Pieces	Code	Price
	from	to									

HUSQVARNA											
Nuda 900	12	14	45	1Q9 M		18	1Q9 T		37	1Q9 C	

KAWASAKI											
ER-6N	09	11	33	9KR M		18	9KR T		40	9KR C	
*ER-6N	12	14	33	2KR M		14	2KR T		46	2KR C	
*Ninja 250R	09	12	12	9K2 M		19	9K2 T		52	9K2 C	
*Ninja 300	13	17	26	3K3 M		27	3K3 T		45	3K3C	
Ninja 400	18	20	27	4K8 M		36	4K8 T		32	4K8 C	
Z 650	17	20	33	6K7 M		17	6K7 T		40	6K7 C	
*Z 650	21	22	32	ENGKA002		17	FRMKA002		42	FARKA002	
Z 750	07	12	32	7K7 M		43	7K7 T		38	7K7 C	
Z 800	13	16	31	3K8 M		22	3K8 T		41	3K8 C	
Z 900	17	23	25	9K7 M		19	9K7 T		24	9K7 C	
Z1000	07	08	42	7K1 M		46	7K1 T		44	7K1 C	
Z1000	09	09	42	9K1 M		45	9K1 T		50	9K1 C	
Z1000	10	13	25	0KZ M		41	0KZ T		47	0KZ C	
Z1000	14	14	26	4KZ M		31	4KZ T		54	4KZ C	
Z1000 SX	11	13	21	1KS M		46	1KS T		50	1KS C	
ZX6R	07	08	37	7K6 M		26	7K6 T		64	7K6 C	
ZX6R	09	12	37	9K6 M		26	9K6 T		58	9K6 C	
ZX6R	13	16	40	6K6 M		23	6K6 T		62	6K6 C	
*ZX10 R	04	05	32	4K1 M		28	4K1 T		58	4K1 C	
*ZX10 R	06	07	36	6K1 M		35	6K1 T		57	6K1 C	
ZX10 R	08	10	26	8K1 M		32	8K1 T		54	8K1 C	
ZX10 R	11	15	33	1K1 M		33	1K1 T		47	1K1 C	
ZX10 R	16	20	25	1K6 M		25	1K6 T		56	1K6 C	
ZX10 R	21	21	23	ENGKA001		10	ENGKA001		29	FARKA001	

KTM											
Duke 125	17	19	31	8M1 M		23	8M1 T		31	8M1 C	
Duke 690	07	10	28	7M6 M		23	7M6 T		26	7M6 C	
Duke 690	12	14	27	2M6 M		22	2M6 T		43	2M6 C	
Super Duke 990	07	10	29	7M9 M		30	7M9 T		21	7M9 C	

MOTO MORINI											
X-Cape 649	22	23	24	ENGMM001		16	FRMMM001		19	FARMM001	
Seiamezzo STR	23	23	31	ENGMM002		13	FRMMM002		16	FARMM002	

NEW
NEW

MV AGUSTA											
Brutale 910	04	10	35	MV5 M		15	MV5 T		47	MV5 C	
B3 675	12	16	30	4V6 M		20	4V6 T		37	4V6 C	
B3 800	13	16	30	4V6 M		20	4V6 T		37	4V6 C	
F3 675	12	14	20	MV3 M		23	MV3 T		59	MV3 C	
F3 800	13	16	22	MV8 M		20	MV8 T		70	MV8 C	
F4 1000	14	14	12	4V1 M		22	4V1 T		37	4V1 C	
Rivale 800	14	17	28	5M8 M		26	5M8 T		73	5M8 C	

SUZUKI											
Gladius	09	13	30	9SG M		20	9SG T		37	9SG C	
GSR 600	06	11	39	6SR M		26	6SR T		28	6SR C	
GSR 750	11	13	34	1SR M		27	1SR T		42	1SR C	
GSXR 600/750	06	07	30	6S6 M		28	6S6 T		47	6S6 C	
GSXR 600/750	08	10	33	8S6 M		26	8S6 T		48	8S6 C	
GSXR 600/750	11	16	31	1SX M		38	1SX T		48	1SX C	
GSXR 1000	05	06	38	5S1 M		38	5S1 T		46	5S1 C	
GSXR 1000	07	08	32	7S1 M		39	7S1 T		48	7S1 C	
GSXR 1000	09	16	25	9S1 M		22	9S1 T		49	9S1 C	
GSXR 1000	17	22	25	1X7 M		29	1X7 T		33	1X7 C	
GSX-S 750	17	21	31	7S7 M		20	7S7 T		31	7S7 C	
GSX-8 S	23	23	31	ENGJU001		3	FRMSU001		15	FARSU001	
GSX-S 1000	15	21	32	5SS M		26	5SS T		39	5SS C	

NEW

	Years		ENGINE			FRAME			FAIRING		
			Pieces	Code	Price	Pieces	Code	Price	Pieces	Code	Price
	from	to									
TRIUMPH											
Daytona 675	07	12	33	7TD M		34	7TD T		46	7TD C	
Speed Triple 1050	11	15	52	0TT M		33	0TT T		48	0TT C	
Speed Triple 1050	16	16	57	6T1 M		24	6T1 T		47	6T1 C	
Speed Triple RS 1200	21	22	38	ENGTR002		6	FRMTR002		13	FARTR002	
Speed Triple 675 / 675R	07	12	36	7T6 M		29	7T6 T		33	7T6 C	
Speed Triple 675 / 675R	13	16	38	3T6 M		33	3T6 T		40	3T6 C	
Speed Triple 765 / 765 R	17	21	39	7T7M		28	7T7T		34	7T7C	
Trident 660	21	22		ENGTR001			FRMTR001			FARTR001	
YAMAHA											
Fazer 600 / FZ6 600	04	12	40	4Y6 M		24	4Y6 T		38	4Y6 C	
FZ1	06	15	35	6Y1 M		22	6Y1 T		58	6Y1 C	
FZ8	10	15	28	0Y8 M		28	0Y8 T		51	0Y8 C	
MT-03	06	13	30	6YM M		25	6YM T		44	6YM C	
MT-07	14	20	31	4Y7 M		22	4Y7 T		51	4Y7 C	
MT-09	13	16	40	3YM M		18	3YM T		44	3YM C	
MT-09 Tracer	15	16	41	5Y9 M		27	5Y9 T		50	5Y9 C	
MT-09	17	20	39	9Y7 M		18	9Y7 T		33	9Y7 C	
MT-09	21	21	34	ENGYA001		19	FRMYA001		15	FARYA001	
Tracer 9 GT	23	23	34	ENGYA003		12	FRMYA003		17	FARYA003	
MT-10	16	20	32	6Y0 M		27	6Y0 T		42	6Y0 C	
R1	04	06	26	4Y1 M		28	4Y1 T		62	4Y1 C	
R1	07	08	33	7Y1 M		33	7Y1 T		52	7Y1 C	
R1	09	14	33	9Y1 M		23	9Y1 T		52	9Y1 C	
R1 / R1M	15	19	28	5Y1 M		27	5Y1 T		53	5Y1 C	
R1 / R1M	20	20	28	5Y1 M		27	5Y1 T		32	0Y1 C	
R3	15	17	27	5Y3 M		23	5Y3 T		45	5Y3 C	
R6	06	07	32	6Y6 M		28	6Y6 T		60	6Y6 C	
R6	08	16	32	8Y6 M		22	8Y6 T		54	8Y6 C	
R6	17	20	29	6Y7 M		16	6Y7 T		31	6Y7 C	
R7	22	22	28	ENGYA002		15	FRMYA002		31	FARYA002	
T Max 500	08	11	17	8YT M		-	-		43	8YT C	
T Max 530	12	16	-	-		16	2YXT		34	2YX C	
XJ6	08	13	28	8YJ M		18	8YJ T		48	8YJ C	
X-Max 400	13	14	15	3YX M		-	-		39	3YX C	





DADI SPECIALI
SPECIAL NUTS
TUERCA ESPECIALES
SPEZIALMUTTERN
スペシャルナット



DADI SPECIALI ERGAL 7075

7075 ERGAL SPECIAL NUTS - TUERCA ESPECIALES EN ERGAL - SPEZIALMUTTERN AUS ERGAL 7075 - ジュラルミン 7075 スペシャルナット



M 25 X 1,5	30
∅ 39 · h 13	Nm 350



D001

M 25 X 1,5	32
∅ 39,5 · h 14	Nm 300



D002

M 24 X 1,5	32
∅ 39 · h 17,5	Nm 330



D003

M 18 X 1,5	22
∅ 29 · h 14	Nm 140



D004

M 22 X 1	32
∅ 39,5 · h 16,5	Nm 250



D005

M 24 X 1,5	30
∅ 37 · h 16,5	Nm 300



D006

M 14 X 1,5	22
∅ 29,5 · h 13	Nm 67



D007

M 38 X 1,5	46
∅ 63,5 · h 28,5	Nm 1240



D008

M 33 X 1,5	41
∅ 49,5 · h 14	Nm 900



D009

M 20 X 1,5	27
∅ 34,8 · h 15	Nm 200



D010

M 16 X 1,5	22
∅ 25,8 · h 14,5	Nm 100



D011

M 24 X 1,5	32
∅ 39,8 · h 14,5	Nm 330



D013

M 28 X 1	34
∅ 42,3 · h 19,7	Nm 520



D014

M 22 X 1,5	32
∅ 38,4 · h 19,5	Nm 270



D018

M 25 X 1,25	28
∅ 33,3 · h 10	Nm 250



D019

M 38 X 1,5	46
∅ 55 · h 19	Nm 1240

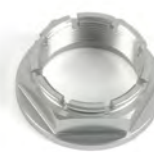

D020

M 35 X 1,5	46
∅ 55 · h 18	Nm 960



D021

M 33 X 1,5	41
∅ 46 · h 16	Nm 850



D022

M 35 X 1,5	46
∅ 55 · h 21	Nm 970



D023

POSITION

- 1 Perno ruota anteriore / Front wheel axle / Tuerca rueda delantera / Vordere Radmutter / フロント ホイール アクスル
- 2 Canotto sterzo / Steering stem head / Tuerca direccion / Lenkermutter / ステアリング システム ヘッド
- 3 Perno forcellone / Swing arm pivot shaft / Tuerca basculante / Radmutter / スイングアーム ピボット シャフト
- 4 Perno ruota posteriore / Rear wheel axle / Tuerca rueda posterior / Hintere radmutter / リア ホイール アクスル

Available colours: ● ● ● ● ● ●



	Year		position 1	position 2	position 3	position 4
	from	to	Code	Code	Code	Code
APRILIA						
Dorsoduro 750	08	13	D001	-	D010	D001
Dorsoduro 1200	11	13	D001	-	D010	D001
RSV 1000	04	05	D001	-	D010	D001
RSV4 / Factory / APRC	09	23	D001	-	D010	D001
Shiver 750	07	13	D001	-	D010	D001
Tuono	06	09	-	-	D010	D001
Tuono V4	11	23	D001	-	D010	D001
BMW						
F800R	10	10	-	-	-	D011
S1000R	14	23	-	-	D004	D003
S1000RR	09	23	-	D014	D004	D003
DUCATI						
748 / 916 / 996 / 998	96	01	D019	-	-	D008 (R side) D009 (L side)
848	08	11	-	-	-	D020 (R side) D009 (L side)
Hypermotard 821	13	14	-	-	-	D020 (R side) D009 (L side)
Hypermotard 1100	07	12	D019	-	-	D008 (R side) D009 (L side)
Monster / 610 ie	03	07	D019	-	-	-
HONDA						
CB 500 F	13	13	-	-	-	D011
CB 650 F	14	15	-	-	D004	D004
CB 1000 R	08	17	-	D006	D004	D023
CBR 250 RR	11	12	-	-	-	D011
CBR 600 F	11	13	-	D006	D004	D004
CBR 600 RR	05	06	-	D006	-	D018
CBR 600 RR	07	16	-	D006	D004	D018
CBR 1000 RR	04	07	-	-	D018	D018
CBR 1000 RR	08	16	-	D022	D018	D018
CBR 1000RR-R / SP	20	22	-	-	-	D003
Hornet 600	03	06	-	D006	D007	D011
Hornet 600	07	13	-	D006	D004	D004
Hornet 900	02	08	-	D006	-	D004
Integra	12	14	-	-	-	D004
NC700X	12	14	-	-	-	D004
XADV	17	23	-	-	-	D004
HUSQVARNA						
Nuda 900	12	15	-	-	D007	D011

DADI SPECIALI ERGAL 7075

7075 ERGAL SPECIAL NUTS - TUERCA ESPECIALES EN ERGAL - SPEZIALMUTTERN AUS ERGAL 7075 - ジュラルミン 7075 スペシャルナット

	Year		position 1	position 2	position 3	position 4
	from	to	Code	Code	Code	Code
KAWASAKI						
Ninja 250 R	09	12	D007	-	-	D011
Ninja 300 R	13	16	-	-	-	-
ZX6R	03	04	-	D002	D010	D003
ER-6N	06	08	-	-	-	D004
ER-6N	09	11	-	-	D010	D004
ER-6N	12	13	-	-	-	D004
Z 650	17	23	-	-	-	D004
Z 750	07	12	-	-	D010	D004
Z 800	12	16	-	-	-	D004
Z 900	17	23	-	-	-	D004
Z 1000	03	06	-	-	D010	D003
Z 1000	07	09	-	-	D010	D003
Z 1000 / Z1000 SX	10	16	-	-	D010	-
ZX6R / 636	06	23	-	D014	D010	D003
ZX10 R	04	05	-	D014	D010	D004
ZX10 R	06	07	-	D014	D010	D004
ZX10 R	08	10	-	-	D010	D004
ZX10 R	11	23	-	D014	D010	D003
MV						
B3 675 / B3 800	12	17	D019	-	-	-
F3 675 / F3 800	12	17	D019	-	-	-
Rivale 800	14	17	D019	-	-	-
SUZUKI						
Gladius	09	13	-	D005	-	D010
GSR 600	06	11	-	D013	D010	D018
GSR 750	11	16	-	-	-	D018
GSXR 1000	05	16	-	D014	D010	D001
GSXR 600 / 750	06	10	-	D014	D010	D001
GSXR 600 / 750	11	17	D010	D014	D010	D018
GSXS 1000 / GSXS 1000F	15	19	D010	-	D010	D001
SV 650 / 650S	03	08	-	D013	D004	D004
TRIUMPH						
Daytona 675 / 675R	07	16	-	D002	D011	D004
Speed Triple 1050 / 1050R	08	16	-	-	-	D020 (right side)
						D021 (left side)
Street Triple 675 / 675R	07	16	-	D002	D011	D004
Street Triple 765 R / S / RS	17	23	-	D002	D011	D004
YAMAHA						
MT-03 (660cc) monocilindrico	06	14	-	D005	D011	D011
MT-03 (321 cc) bicilindrico	16	18	-	-	-	D011
MT-07	13	20	-	-	-	D004
MT-09 / MT-09 Tracer	13	20	-	-	-	D004
MT-09	21	23	-	-	-	D003
MT10	16	21	-	-	-	D003
Fazer 600 / FZ6	04	12	-	D005	D004	D003
FZ8	10	16	-	D014	D004	D003
FZ1 / Fazer 1000	06	12	-	D014	D004	D003
R1	04	06	-	D014	D004	D003
R1	07	14	-	D014	D010	D003
R1 / R1M	15	23	-	-	-	D003
R3	15	23	-	-	-	D011
R6	06	23	-	D014	D018	D003
R7	22	23	-	-	-	D003
T-Max 530 / 560	12	23	-	-	-	D013
XJ6	08	12	-	D005	D007	D011

CARBONIO
CARBON
CARBONO
CARBONTEILE
カーボン



COMPONENTI IN CARBONIO

CARBON PARTS - COMPONENTES CARBONO - CARBONTEILE - カーボン パーツ

APRILIA	Year		Code	AC	Code	Price
	from	to	SHINE		MATT	
RS660 / TUONO 660						
parafango ant. / front mudguard / guardabarros delantero / Vordere kotflügel / フロント マッドガード	20	23	CARA0610	✓		
copri catena / chain cover / cubrecadena / Kette Abdeckung / チェーン カバー	20	23	CARA0612	✓		
parafango post. / rear mudguard / guardabarros trasero / Hintere kotflügel / リア マッドガード	20	23	CARA0620	✓		
copri serbatoio / tank cover / tapa deposito / Tankdeckel / タンク カバー	20	23	CARA0629	✓		
protezioni telaio / frame protector / protección chasis / Rahmen Abdeckung / フレーム プロテクター	20	23	CARA0650	✓		
protezioni forcellone / swingarm protector / protección basculante / SchwingenAbdeckung / スイングアーム プロテクター	20	23	CARA0660	✓		
fianchetti laterali sotto serbatoio / under tank panels / laterales bajo deposito / Tankschutz (unten) / アンダー タンク パネル	20	23	CARA0680	✓		
protezioni serbatoio / tank protector / protección del tanque / Tankschutz / タンクプロテクター	20	23	CARA0685	✓		
RSV4 (all models)						
parafango ant. / front mudguard / guardabarros delantero / Vordere kotflügel / フロント マッドガード	09	14	CARA3010	✓		
parafango post. / rear mudguard / guardabarros trasero / Hintere kotflügel / リア マッドガード	09	14	CARA3020	✓		
coperchio frizione / clutch cover / guardabarros trasero / Kupplungs - Deckel / クラッチ カバー /	09	14	CARA3030			
coperchio alternatore / electric cover / tapa alternador / Lichtmaschine Deckel / ジェネレーター カバー	09	14	CARA3040			
protezioni telaio / frame protector / protección chasis / Rahmen Abdeckung / フレーム プロテクター	09	14	CARA3050	✓		
protezioni forcellone / swingarm protector / protección basculante / SchwingenAbdeckung / スイングアーム プロテクター	09	14	CARA3060	✓		
tubi airbox / racing airducts / tubos air box / Airbox Rohre / レーシング エアダクト	09	14	CARA3019	✓		
copri catena / chain cover / cubrecadena / Kette Abdeckung / チェーン カバー	09	14	CARA3012	✓		
para catena inferiore / inferior chain protection / cubrecadena inferior / Untere Kette Abdeckung / スプロケット ガード	09	14	CARA3013	✓		
fianchetti laterali sotto serbatoio / under tank panels / laterales bajo deposito / Tankschutz (unten) / アンダー タンク パネル	09	14	CARA3080	✓		
RSV4 (all models)						
parafango ant. / front mudguard / guardabarros delantero / Vordere kotflügel / フロント マッドガード	15	20	CARA3010	✓		
parafango post. / rear mudguard / guardabarros trasero / Hintere kotflügel / リア マッドガード	15	20	CARA3020	✓		
coperchio frizione / clutch cover / guardabarros trasero / Kupplungs - Deckel / クラッチ カバー /	15	20	CARA3030			
coperchio alternatore / electric cover / tapa alternador / Lichtmaschine Deckel / ジェネレーター カバー	15	20	CARA3040			
protezioni telaio / frame protector / protección chasis / Rahmen Abdeckung / フレーム プロテクター	15	20	CARA4050	✓		
protezioni forcellone / swingarm protector / protección basculante / SchwingenAbdeckung / スイングアーム プロテクター	15	20	CARA4060	✓		
tubi airbox / racing airducts / tubos air box / Airbox Rohre / レーシング エアダクト	15	20	CARA3019	✓		
copri catena / chain cover / cubrecadena / Kette Abdeckung / チェーン カバー	15	20	CARA3012	✓		
para catena inferiore / inferior chain protection / cubrecadena inferior / Untere Kette Abdeckung / スプロケット ガード	15	20	CARA3013	✓		
fianchetti laterali sotto serbatoio / under tank panels / laterales bajo deposito / Tankschutz (unten) / アンダー タンク パネル	15	20	CARA3080	✓		



	Year		Code	AC	Code	Price
	from	to	SHINE		MATT	
RSV4 1100 Factory						
parafango ant. / front mudguard / guardabarros delantero / Vordere kotflügel / フロント マッドガード	21	23	CARA0610	✓		
parafango post. / rear mudguard / guardabarros trasero / Hintere kotflügel / リア マッドガード	21	23	CARA2020	✓		
coperchio frizione / clutch cover / guardabarros trasero / Kupplungs - Deckel / クラッチ カバー /	21	23	CARA3030			
protezioni telaio / frame protector / protección chasis / Rahmen Abdeckung / フレーム プロテクター	21	23	CARA4050	✓		
protezioni forcellone / swingarm protector / protección basculante / SchwingenAbdeckung / スイングアーム プロテクター	21	23	CARA2060	✓		
copri catena / chain cover / cubrecadena / Kette Abdeckung / チェーン カバー	21	23	CARA2012	✓		
protezioni serbatoio / tank protector / protección del tanque / Tankschutz / タンクプロテクター	21	23	CARA2090	✓		
fianchetti laterali sotto serbatoio / under tank panels / laterales bajo deposito / Tankschutz (unten) / アンダー タンク パネル	21	23	CARA2080	✓		
tubi airbox / racing airducts / tubos air box / Airbox Rohre / レーシング エアダクト	21	23	CARA2019	✓		

TUONO V4						
parafango ant. / front mudguard / guardabarros delantero / Vordere kotflügel / フロント マッドガード	11	20	CARA3010	✓		
parafango post. / rear mudguard / guardabarros trasero / Hintere kotflügel / リア マッドガード	11	20	CARA3020	✓		
coperchio frizione / clutch cover / guardabarros trasero / Kupplungs - Deckel / クラッチ カバー /	11	20	CARA3030			
coperchio alternatore / electric cover / tapa alternador / Lichtmaschine Deckel / ジェネレーター カバー	11	20	CARA3040			
protezioni telaio / frame protector / protección chasis / Rahmen Abdeckung / フレーム プロテクター	11	20	CARA3050	✓		
protezioni forcellone / swingarm protector / protección basculante / SchwingenAbdeckung / スイングアーム プロテクター	11	20	CARA3060	✓		
copri catena / chain cover / cubrecadena / Kette Abdeckung / チェーン カバー	11	20	CARA3012	✓		
para catena inferiore / inferior chain protection / cubrecadena inferior / Untere Kette Abdeckung / スプロケット ガード	11	20	CARA3013	✓		
fianchetti laterali sotto serbatoio / under tank panels / laterales bajo deposito / Tankschutz (unten) / アンダー タンク パネル	11	20	CARA3080	✓		

TUONO V4 Factory						
parafango ant. / front mudguard / guardabarros delantero / Vordere kotflügel / フロント マッドガード	21	22	CARA0610	✓		
parafango post. / rear mudguard / guardabarros trasero / Hintere kotflügel / リア マッドガード	21	22	CARA2020	✓		
coperchio frizione / clutch cover / guardabarros trasero / Kupplungs - Deckel / クラッチ カバー /	21	22	CARA3030			
protezioni telaio / frame protector / protección chasis / Rahmen Abdeckung / フレーム プロテクター	21	22	CARA4050	✓		
protezioni forcellone / swingarm protector / protección basculante / SchwingenAbdeckung / スイングアーム プロテクター	21	22	CARA2060	✓		
copri catena / chain cover / cubrecadena / Kette Abdeckung / チェーン カバー	21	22	CARA2012			
protezioni serbatoio / tank protector / protección del tanque / Tankschutz / タンクプロテクター	21	22	CARA2090			
fianchetti laterali sotto serbatoio / under tank panels / laterales bajo deposito / Tankschutz (unten) / アンダー タンク パネル	21	22	CARA2080	✓		



COMPONENTI IN CARBONIO

CARBON PARTS - COMPONENTES CARBONO - CARBONTEILE - カーボンパーツ

BMW	Year		Code	AC	Code	Price
	from	to	SHINE		MATT	
R-NINE T Scrambler						
protezioni teste motore / engine covers / protección culata motor / Motorschutz / エンジンカバー	14	19	CARB2000	✓	CARB2000M	
parafango ant. (fissaggio laterale) / front mudguard (side fitment) / guardabarros delantero (sujeción lateral) / Vordere Kotflügel (seitliche Befestigung) / サイド固定式 フロントマッドガード	14	19	CARB2010	✓	CARB2010M	
parafango ant. (fissaggio superiore) / front mudguard (upper fitment) / guardabarros delantero (sujeción superior) / Vordere Kotflügel (obere Befestigung) / 上部固定式 フロントマッドガード	17	20	CARB2210	✓	CARB2210M	
S 1000 R						
parafango ant. / front mudguard / guardabarros delantero / Vordere kotflügel / フロント マッドガード	13	20	CARB1010	✓		
parafango post. / rear mudguard / guardabarros trasero / Hintere kotflügel / リア マッドガード	13	20	CARB1020	✓		
coperchio frizione / clutch cover / guardabarros trasero / Kupplungs - Deckel / クラッチ カバー /	13	14	CARB1030			
coperchio frizione / clutch cover / guardabarros trasero / Kupplungs - Deckel / クラッチ カバー /	15	20	CARB1031			
coperchio alternatore / electric cover / tapa alternador / Lichtmaschine Deckel / ジェネレーター カバー	13	20	CARB1040			
coperchio pick up / pick up cover / tapa pick up / pick up Deckel / ピックアップ カバー	13	16	CARB1018			
protezioni telaio / frame protector / protección chasis / Rahmen Abdeckung / フレーム プロテクター	13	16	CARB1050	✓		
protezioni telaio / frame protector / protección chasis / Rahmen Abdeckung / フレーム プロテクター	17	20	CARB1051	✓		
protezioni forcellone / swingarm protector / protección basculante / SchwingenAbdeckung / スイングアーム プロテクター	13	16	CARB1060	✓		
protezioni forcellone / swingarm protector / protección basculante / SchwingenAbdeckung / スイングアーム プロテクター	17	20	CARB1061	✓		
S 1000 R						
parafango ant. / front mudguard / guardabarros delantero / Vordere kotflügel / フロント マッドガード	21	23	CARB1910	✓		
parafango post. / rear mudguard / guardabarros trasero / Hintere kotflügel / リア マッドガード	21	23	CARB1920	✓		
coperchio pick up / pick up cover / tapa pick up / pick up Deckel / ピックアップ カバー	21	23	CARB1918	✓		
coperchio frizione / clutch cover / guardabarros trasero / Kupplungs - Deckel / クラッチ カバー /	21	23	CARB1930	✓		
coperchio alternatore / electric cover / tapa alternador / Lichtmaschine Deckel / ジェネレーター カバー	21	23	CARB1940	✓		
protezioni telaio / frame protector / protección chasis / Rahmen Abdeckung / フレーム プロテクター	21	23	CARB1950	✓		
protezioni forcellone / swingarm protector / protección basculante / SchwingenAbdeckung / スイングアーム プロテクター	21	23	CARB1960	✓		
copri serbatoio / tank cover / tapa deposito / Tankdeckel / タンク カバー	21	23	CARB1929	✓		
copri pignone / sprocket cover / cubre piñón / Ritzelabdeckung / スプロケットカバー	21	23	CARB1945	✓		
fianchetti laterali sotto serbatoio / under tank panels / laterales bajo deposito / Tankschutz (unten) / アンダー タンク パネル	21	23	CARB1980	✓		
S 1000 RR						
parafango ant. / front mudguard / guardabarros delantero / Vordere kotflügel / フロント マッドガード	09	18	CARB1010	✓		
parafango post. / rear mudguard / guardabarros trasero / Hintere kotflügel / リア マッドガード	09	18	CARB1020	✓		
coperchio frizione / clutch cover / guardabarros trasero / Kupplungs - Deckel / クラッチ カバー /	09	14	CARB1030			
coperchio frizione / clutch cover / guardabarros trasero / Kupplungs - Deckel / クラッチ カバー /	15	18	CARB1031			
coperchio alternatore / electric cover / tapa alternador / Lichtmaschine Deckel / ジェネレーター カバー	09	18	CARB1040			
coperchio pick up / pick up cover / tapa pick up / pick up Deckel / ピックアップ カバー	09	16	CARB1018			
protezioni telaio / frame protector / protección chasis / Rahmen Abdeckung / フレーム プロテクター	09	14	CARB1050	✓		
protezioni telaio / frame protector / protección chasis / Rahmen Abdeckung / フレーム プロテクター	15	18	CARB1051	✓		
protezioni forcellone / swingarm protector / protección basculante / SchwingenAbdeckung / スイングアーム プロテクター	09	14	CARB1060	✓		
protezioni forcellone / swingarm protector / protección basculante / SchwingenAbdeckung / スイングアーム プロテクター	15	18	CARB1061	✓		
S 1000 RR						
parafango ant. / front mudguard / guardabarros delantero / Vordere kotflügel / フロント マッドガード	19	23	CARB1910	✓		
parafango post. / rear mudguard / guardabarros trasero / Hintere kotflügel / リア マッドガード	19	23	CARB1920	✓		
coperchio pick up / pick up cover / tapa pick up / pick up Deckel / ピックアップ カバー	19	23	CARB1918	✓		
coperchio frizione / clutch cover / guardabarros trasero / Kupplungs - Deckel / クラッチ カバー /	19	23	CARB1930	✓		
coperchio alternatore / electric cover / tapa alternador / Lichtmaschine Deckel / ジェネレーター カバー	19	23	CARB1940	✓		
protezioni telaio / frame protector / protección chasis / Rahmen Abdeckung / フレーム プロテクター	19	23	CARB1950	✓		
protezioni forcellone / swingarm protector / protección basculante / SchwingenAbdeckung / スイングアーム プロテクター	19	23	CARB1960	✓		
copri serbatoio / tank cover / tapa deposito / Tankdeckel / タンク カバー	19	23	CARB1929	✓		
copri pignone / sprocket cover / cubre piñón / Ritzelabdeckung / スプロケットカバー	19	23	CARB1945	✓		
fianchetti laterali sotto serbatoio / under tank panels / laterales bajo deposito / Tankschutz (unten) / アンダー タンク パネル	19	23	CARB1980	✓		

MULTISTRADA V4
CARD0201MMULTISTRADA V4
CARD0202M

DUCATI	Year		Code	AC	Code	Price
	from	to	SHINE		MATT	
HYPERMOTARD 950						
copri catena / chain cover / cubrecadena / Kette Abdeckung / チェーン カバー	19	23	CARD0412	✓		
parafango post. / rear mudguard / guardabarros trasero / Hintere Kotflügel / リア マッドガード	19	23	CARD0420	✓		
protezioni forcellone / swingarm protector / protección basculante / Schwingenabdeckung / スイングアーム プロテクター	19	23	CARD0460	✓		
copri serbatoio / tank cover / tapa deposito / Tankdeckel / タンク カバー	19	23	CARD0429	✓		
coperture laterali scarico / side panels-exhaust / tapas laterales para escape / Seitenabdeckungen für Auspuff / エキゾーストパイプカバー	19	23	CARD0402	✓		
copertura laterale radiatore / side cover for radiator / protección lateral para radiador Seitenabdeckung für Kühler / ラジエーターサイドカバー	19	23	CARD0425	✓		
cover scarico / exhaust cover / tapa de escape / Auspuffabdeckung Exhaust / エキゾーストカバー	19	23	CARD0485	✓		

NEW MULTISTRADA V4

paratacchi in carbonio / carbon heel guards / protectores de talón de carbono / Carbon Fersenschutz / カーボンヒールガード	21	24	CARD0201	✓	CARD0201M	
protezioni mani / hand guards / paramanos / Handschutz / ハンドガード	21	24	CARD0202	✓	CARD0202M	
parafango ant. / front mudguard / guardabarros delantero / Vordere Kotflügel / フロント マッドガード	21	24	CARD0210	✓	CARD0210M	
parafango post. / rear mudguard / guardabarros trasero / Hintere Kotflügel / リア マッドガード	21	24	CARD0220	✓	CARD0220M	
copri catena anteriore / front chain cover / cubrecadena delantero / Vordere Kette Abdeckung / フロントチェーンカバー	21	24	CARD0214	✓	CARD0214M	
coperchio frizione / clutch cover / guardabarros trasero / Kupplungs - Deckel / クラッチ カバー /	21	24	CARD0730	✓	CARD0730M	
protezioni telaio / frame protector / protección chasis / Rahmen Abdeckung / フレーム プロテクター	21	24	CARD0250	✓	CARD0250M	
fianchetti laterali sotto serbatoio / under tank panels / laterales bajo deposito / Tankschutz (unten) / アンダー タンク パネル	21	24	CARD0280	✓	CARD0280M	
cover teste motore DX / head cover R side / tapa cabezas lado derecho / Kopfabdeckung R Seite / ヘッドカバー (右側)	21	24	CARD0241	✓	CARD0241M	
fianchetti laterali carena DX+SX / fairing side panels R+L / lados carenado lado derecho e izquierdo Kopfabdeckung Rechte und Linke Seite verkleidung / サイドフェアリング (右左セット)	21	24	CARD0281	✓	CARD0281M	
fianchetti interni carena DX+SX / inner side fairing R+L / lados internos carenado derecho e izquierdo Rechte und Linke Seite Innenverkleidung / インナーサイドフェアリング (右左セット)	21	24	CARD0282	✓	CARD0282M	
deflettori sotto cupolino DX+SX / under windshield deflectors R+L / defletores debajo del parabrisas derecho+izquierdo Rechte und Linke Seite unter der Windschutzscheibe Deflektoren / ウインドデフレクター (右左セット)	21	24	CARD0215	✓	CARD0215M	
copri serbatoio / tank cover / tapa deposito / Tankdeckel / タンク カバー	21	24	CARD0229	✓	CARD0229M	
kit frontale carena / front fairing kit / kit carenado delantero / Frontverkleidungssatz / フロントフェアリングキット	21	24	CARD0270	✓	CARD0270M	
cupolino / windscreen / cúpula / Windschild / ウィンドスクリーン	21	24	CARD0271	✓	CARD0271M	
cover superiore terminale di scarico / upper cover exhaust / tapa superior escape / Obere Auspuffabdeckung / サイレンサー用アッパーカバー	21	24	CARD0285	✓	CARD0285M	
cover terminale di scarico Akrapovic / Akrapovic cover exhaust / Akrapovic tapa escape Akrapovic Auspuffabdeckung / AKRAPOVIC製サイレンサー用カバー	21	24	CARD0286	✓	CARD0285M	
protezione inferiore scarico / lower exhaust protection / protección de escape inferior Unterer Auspuffschutz / エキゾースト アンダー プロテクション	21	24	CARD0288	✓	CARD0288M	



CARD0210M

CARD0220M



CARD0281

CARD0215M



CARD0280M



CARD0270M



COMPONENTI IN CARBONIO

CARBON PARTS - COMPONENTES CARBONO - CARBONTEILE - カーボンパーツ

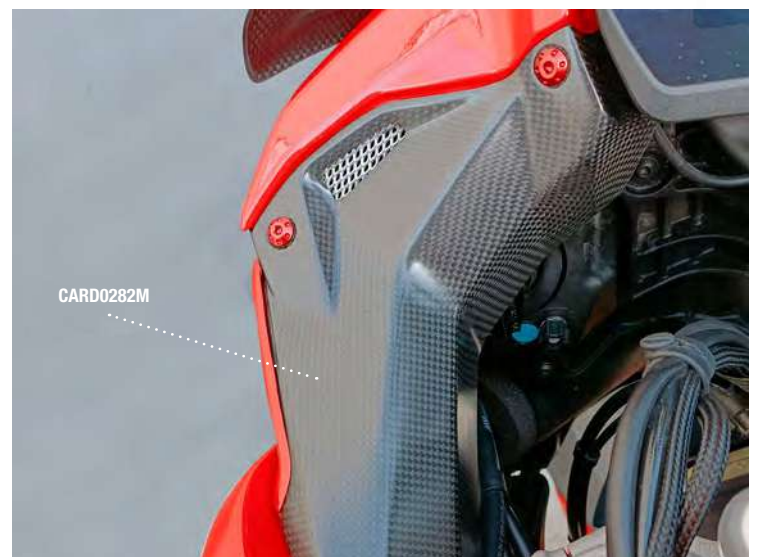

MULTISTRADA V4
CARD0282



MULTISTRADA V4 PIKES PEAK
CARD0221

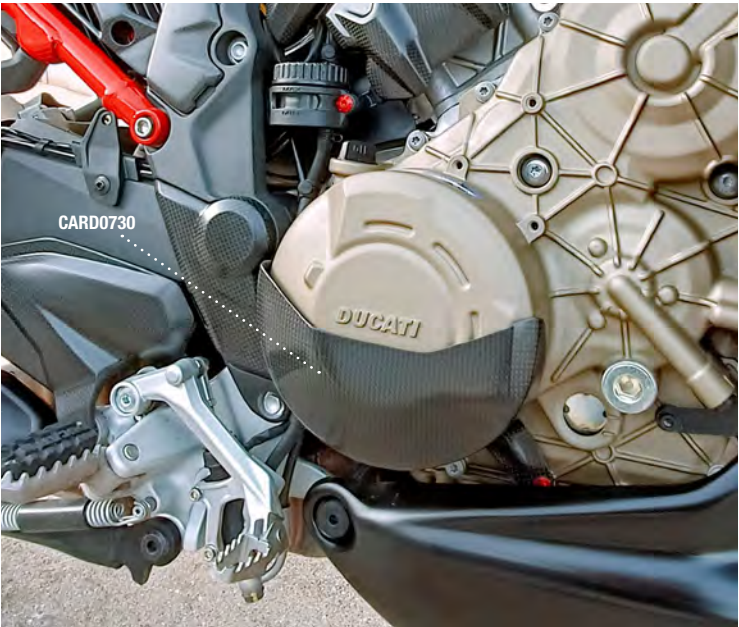

CARD0280



COMPONENTI IN CARBONIO

CARBON PARTS - COMPONENTES CARBONO - CARBONTEILE - カーボンパーツ

DUCATI	Year		Code	AC	Code	Price
	from	to	SHINE		MATT	
NEW MULTISTRADA V4 PIKES PEAK						
paratacchi in carbonio / carbon heel guards / protectores de talón de carbono / Carbon Fersenschutz / カーボンヒールガード	22	24	CARD0201	✓	CARD0201M	
protezioni mani / hand guards / paramanos / Handschutz / ハンドガード	22	24	CARD0202	✓	CARD0202M	
parafango ant. / front mudguard / guardabarros delantero / Vordere Kotflügel / フロント マッドガード	22	24	CARD0210	✓	CARD0210M	
copri catena / chain cover / cubrecadena / Kette Abdeckung / チェーンカバー	22	24	CARD0212	✓	CARD0212M	
parafango post. / rear mudguard / guardabarros trasero / Hintere Kotflügel / リア マッドガード	22	24	CARD0221	✓	CARD0221M	
coperchio frizione / clutch cover / guardabarros trasero / Kupplungs - Deckel / クラッチ カバー /	22	24	CARD0730	✓	CARD0730M	
protezioni forcellone / swingarm protector / protección basculante / SchwingenAbdeckung / スイングアーム プロテクター	22	24	CARD0260	✓	CARD0260M	
copri catena / chain cover / cubrecadena / Kette Abdeckung / チェーンカバー	22	24	CARD0212	✓	CARD0212M	
protezione catena inferiore / lower chain cover / cubrecadena inferior / Unterer Kette Abdeckung / フロントチェーンカバー	22	24	CARD0213	✓	CARD0213M	
fianchetti laterali sotto serbatoio / under tank panels / laterales bajo deposito / Tankschutz (unten) / アンダー タンク パネル	22	24	CARD0280	✓	CARD0280M	
cover teste motore DX / head cover R side / tapa cabezas lado derecho/ Kopfabdeckung R Seite / ヘッドカバー (右側)	22	24	CARD0241	✓	CARD0241M	
fianchetti laterali carena DX+SX / fairing side panels R+L / lados carenado lado derecho e izquierdo Kopfabdeckung Rechte und Linke Seite verkleidung / サイドフェアリング (右左セット)	22	24	CARD0281	✓	CARD0281M	
fianchetti interni carena DX+SX / inner side fairing R+L / lados internos carenado derecho e izquierdo Rechte und Linke Seite Innenverkleidung / インナーサイドフェアリング (右左セット)	22	24	CARD0282	✓	CARD0282M	
deflettori sotto cupolino DX+SX / under windshield deflectors R+L / defletores debajo del parabrisas derecho+izquierdo Rechte und Linke Seite unter der Windschutzscheibe Deflektoren / ウインドデフレクター (右左セット)	22	24	CARD0215	✓	CARD0215M	
copri serbatoio / tank cover / tapa deposito / Tankdeckel / タンク カバー	22	24	CARD0229	✓	CARD0229M	
kit frontale carena / front fairing kit / kit carenado delantero / Frontverkleidungssatz / フロントフェアリングキット	22	24	CARD0270	✓	CARD0270M	
cover terminale di scarico originale / original cover exhaust / tapa escape original / Original Auspuffabdeckung / 純正サイレンサー用カバー	22	24	CARD0285	✓	CARD0285M	
fondello scarico originale / bottom original exhaust / escape abajo original / Unterer Original-Auspuff / 純正サイレンサー用エンドキャップ	22	24	CARD0286	✓	CARD0286M	
cover superiore terminale di scarico Akrapovic / Akrapovic upper cover exhaust / Akrapovic tapa superior escape Akrapovic Obere Auspuffabdeckung / AKRAPOVIC製サイレンサー用アッパーカバー	22	24	CARD0287	✓	CARD0287M	
protezione inferiore scarico / lower exhaust protection / protección de escape inferior Unterer Auspuffschutz / エキゾースト アンダー プロテクション	22	24	CARD0288	✓	CARD0288M	

MULTISTRADA V4 PIKES PEAK
CARD0212MULTISTRADA V4 PIKES PEAK
CARD0213

DUCATI	Year		Code	AC	Code	Price
	from	to	SHINE		MATT	
PANIGALE 899						
parafango ant. / front mudguard / guardabarros delantero / Vordere kotflügel / フロント マッドガード	13	15	CARD1010	✓		
coperchio alternatore / electric cover / tapa alternador / Lichtmaschine Deckel / ジェネレーター カバー	13	15	CARD1040			
protezione molla mono / rear shock absorber protector / protección mono amortiguador Zentralfederschutz (hinten) / リア ショック アブソーバー プロテクション	13	15	CARD1039	✓		
PANIGALE 1199 / 1299						
parafango ant. / front mudguard / guardabarros delantero / Vordere kotflügel / フロント マッドガード	12	17	CARD1010	✓		
parafango post. / rear mudguard / guardabarros trasero / Hintere kotflügel / リア マッドガード	12	17	CARD1020	✓		
coperchio frizione / clutch cover / guardabarros trasero / Kupplungs - Deckel / クラッチ カバー /	12	17	CARD1030			
coperchio alternatore / electric cover / tapa alternador / Lichtmaschine Deckel / ジェネレーター カバー	12	17	CARD1040			
protezioni forcellone / swingarm protector / protección basculante / SchwingenAbdeckung / スイングアーム プロテクター	12	17	CARD1060	✓		
copri catena / chain cover / cubrecadena / Kette Abdeckung / チェーン カバー	12	17	CARD1012	✓		
protezione molla mono / rear shock absorber protector / protección mono amortiguador Zentralfederschutz (hinten) / リア ショック アブソーバー プロテクション	12	17	CARD1039	✓		
PANIGALE V4 / S						
paratacchi in carbonio / carbon heel guards / protectores de talón de carbono / Carbon Fersenschutz / カーボンヒールガード	18	23	CARD0801	✓	CARD0801M	
parafango ant. / front mudguard / guardabarros delantero / Vordere kotflügel / フロント マッドガード	18	23	CARD0810	✓	CARD0810M	
parafango post. / rear mudguard / guardabarros trasero / Hintere kotflügel / リア マッドガード	18	23	CARD0820	✓	CARD0820M	
coperchio frizione / clutch cover / guardabarros trasero / Kupplungs - Deckel / クラッチ カバー /	18	23	CARD0830	✓	CARD0830M	
coperchio alternatore / electric cover / tapa alternador / Lichtmaschine Deckel / ジェネレーター カバー	18	23	CARD0840	✓	CARD0840M	
cover teste L+R / head cover L+R / tapa cabezas L+R / Kopfbedeckung L+R / ヘッドカバー 左+右	18	23	CARD0841	✓	CARD0841M	
protezioni telaio / frame protector / protección chasis / Rahmen Abdeckung / フレーム プロテクター	18	23	CARD0850	✓	CARD0850M	
protezioni forcellone / swingarm protector / protección basculante / Schwingen Abdeckung / スイングアーム プロテクター	18	23	CARD0860	✓	CARD0860M	
slider in alluminio per protezione forcellone / alu-slider for carbon swingarm protection / alu-slider para protección de basculante de carbono / Alu -Slider für die Schwingen Carbon Abdeckung / アルミニウム製 スイングアーム プロテクションスライダー	18	23	CARD0861-01sil	✓		
copri serbatoio totale / total tank cover / tapa total de deposito / gesamte Tankabdeckung / フルタンクカバー	18	21	CARD0827	✓	CARD0827M	
copri serbatoio totale / total tank cover / tapa total de deposito / gesamte Tankabdeckung / フルタンクカバー	22	23	CARD0826	✓	CARD0826M	
copri serbatoio con cover chiave integrato / tank cover with key cover / tapa deposito con tapa de llave integrada Tankdeckel mit integriertem Schlüsseldeckel / キーカバー付きタンクカバー	18	21	CARD0828	✓	CARD0828M	
copri serbatoio / tank cover / tapa deposito / Tankdeckel / タンク カバー	18	21	CARD0829	✓	CARD0829M	
copri serbatoio / tank cover / tapa deposito / Tankdeckel / タンク カバー	22	23	CARD0825	✓	CARD0825M	
fianchetti laterali sotto serbatoio / under tank panels / laterales bajo deposito / Tankschutz (unten) / アンダー タンク パネル	18	23	CARD0880	✓	CARD0880M	
fianchetti laterali sotto serbatoio / under tank panels / laterales bajo deposito / Tankschutz (unten) / アンダー タンク パネル	18	23	CARD0881	✓	CARD0881M	
codone / tail / colin / Das Eck / テールカウル	18	23	CARD0890	✓	CARD0890M	
deflettori laterali / side deflectors / deflector lateral / Seitliche Entlüfter / サイドデフレクター	18	23	CARD0815	✓	CARD0815M	
cover sellino / passenger seat cover / funda de asiento del pasajero / Beifahrersitzbezug / タンデムシートカバー	18	23	CARD0892	✓	CARD0892M	

MULTISTRADA V4 PIKES PEAK
CARD0221



PANIGALE V4
CARD0827



PANIGALE V4
CARD0841



COMPONENTI IN CARBONIO

CARBON PARTS - COMPONENTES CARBONO - CARBONTEILE - カーボンパーツ

DUCATI	Year		Code	AC	Code	Price
	from	to	SHINE		MATT	
STREETFIGHTER V4 / V4 S						
paratacchi in carbonio / carbon heel guards / protectores de talón de carbono / Carbon Fersenschutz / カーボンヒールガード	20	23	CARD0801	✓	CARD0801M	
parafango ant. / front mudguard / guardabarros delantero / Vordere kotflügel / フロント マッドガード	20	23	CARD0810	✓	CARD0810M	
parafango post. / rear mudguard / guardabarros trasero / Hintere kotflügel / リア マッドガード	20	23	CARD0820	✓	CARD0820M	
coperchio frizione / clutch cover / guardabarros trasero / Kupplungs - Deckel / クラッチ カバー /	20	23	CARD0730	✓	CARD0730M	
coperchio alternatore / electric cover / tapa alternador / Lichtmaschine Deckel / ジェネレーター カバー	20	23	CARD0840	✓	CARD0840M	
cover teste L+R / head cover L+R / tapa cabezas L+R / Kopfbedeckung L+R / ヘッドカバー 左+右	20	23	CARD0841	✓	CARD0841M	
protezioni telaio / frame protector / protección chasis / Rahmen Abdeckung / フレーム プロテクター	20	23	CARD0750	✓	CARD0750M	
protezioni forcellone / swingarm protector / protección basculante / Schwingen Abdeckung / スイングアーム プロテクター	20	23	CARD0760	✓	CARD0760M	
copri serbatoio / tank cover / tapa deposito / Tankdeckel / タンク カバー	20	23	CARD0729	✓	CARD0729M	
codone / tail / colin / Das Eck / テールカウル	20	23	CARD0890	✓	CARD0890M	
fianchetti laterali sotto serbatoio / under tank panels / laterales bajo deposito / Tankschutz (unten) / アンダー タンク パネル	20	23	CARD0780	✓	CARD0780M	
copertura laterale superiore radiatore / radiator upper side cover / cubierta lateral superior del radiador Oberseitige Kühlerabdeckung / ラジエーター カバー (上部)	20	23	CARD0725	✓	CARD0725M	
copertura laterale inferiore radiatore / radiator lower side cover / cubierta lateral inferior del radiador Kühlerabdeckung an der Unteren Seite / ラジエーター カバー (下部)	20	23	CARD0726	✓	CARD0726M	
frontalino copri strumenti / attachometer support cover / frontal cubre instrumentos / Instrumentenabdeckung タコメーターサポートカバー	20	23	CARD0770	✓	CARD0770M	
cover sellino / passenger seat cover / funda de asiento del pasajero / Beifahrersitzbezug / タンデムシートカバー	20	23	CARD0892	✓	CARD0892M	



HONDA	Year		Code	AC	Code	Price
	from	to	SHINE		MATT	
CB 1000 R						
parafango ant. / front mudguard / guardabarros delantero / Vordere Kotflügel / フロント マッドガード	18	20	CARH7710			
copri catena / chain cover / cubrecadena / Kette Abdeckung / チェーン カバー	18	20	CARH7712	✓		
protezione corona / sprocket protector / cubre piñon / Rad Protektor / スプロケット カバー	18	20	CARH7713	✓		
parafango post. / rear mudguard / guardabarros trasero / Hintere Kotflügel / リア マッドガード	18	20	CARH7720			
coperchio frizione pick up / clutch cover pick up / tapa embrague pick up / Kupplungs pick up Deckel / クラッチ カバー	18	20	CARH7730			
coperchio alternatore / electric cover / tapa alternador / Lichtmaschine Deckel / ジェネレーター カバー	18	20	CARH7740			
protezioni forcellone / swingarm protector / protección basculante / Schwingen Abdeckung / スイングアーム プロテクター	18	20	CARH7760	✓		
frontalino copri strumenti / tachometer support cover / soportes relojes / Instrumenten Halterung / タコメーター サポート カバー	18	20	CARH7770	✓		
CBR 600 RR						
parafango ant. / front mudguard / guardabarros delantero / Vordere Kotflügel / フロント マッドガード	07	16	CARH6510			
parafango post. / rear mudguard / guardabarros trasero / Hintere Kotflügel / リア マッドガード	07	16	CARH8920	✓		
coperchio frizione / clutch cover / guardabarros trasero / Kupplungs - Deckel / クラッチ カバー /	07	16	CARH6530			
coperchio alternatore / electric cover / tapa alternador / Lichtmaschine Deckel / ジェネレーター カバー	07	16	CARH6540			
protezioni telaio / frame protector / protección chasis / Rahmen Abdeckung / フレーム プロテクター	07	16	CARH6550			
protezioni forcellone / swingarm protector / protección basculante / Schwingen Abdeckung / スイングアーム プロテクター	07	16	CARH6560			
CBR 1000 RR						
parafango ant. / front mudguard / guardabarros delantero / Vordere Kotflügel / フロント マッドガード	08	16	CARH1710			
copri catena / chain cover / cubrecadena / Kette Abdeckung / チェーン カバー	08	16	CARH1712	✓		
parafango post. / rear mudguard / guardabarros trasero / Hintere Kotflügel / リア マッドガード	08	11	CARH7620			
parafango post. / rear mudguard / guardabarros trasero / Hintere Kotflügel / リア マッドガード	12	16	CARH1720			
coperchio alternatore / electric cover / tapa alternador / Lichtmaschine Deckel / ジェネレーター カバー	08	16	CARH7640			
coperchio frizione / clutch cover / guardabarros trasero / Kupplungs - Deckel / クラッチ カバー /	08	16	CARH7630			
protezioni telaio / frame protector / protección chasis / Rahmen Abdeckung / フレーム プロテクター	08	16	CARH7650	✓		
protezioni forcellone / swingarm protector / protección basculante / Schwingen Abdeckung / スイングアーム プロテクター	08	16	CARH7660	✓		
CBR 1000 RR						
parafango ant. / front mudguard / guardabarros delantero / Vordere Kotflügel / フロント マッドガード	17	19	CARH1710			
copri catena / chain cover / cubrecadena / Kette Abdeckung / チェーン カバー	17	19	CARH1712	✓		
parafango post. / rear mudguard / guardabarros trasero / Hintere Kotflügel / リア マッドガード	17	19	CARH1720			
coperchio frizione / clutch cover / guardabarros trasero / Kupplungs - Deckel / クラッチ カバー /	17	19	CARH1730			
coperchio alternatore / electric cover / tapa alternador / Lichtmaschine Deckel / ジェネレーター カバー	17	19	CARH1740			
protezioni telaio / frame protector / protección chasis / Rahmen Abdeckung / フレーム プロテクター	17	19	CARH1750	✓		
protezioni forcellone / swingarm protector / protección basculante / Schwingen Abdeckung / スイングアーム プロテクター	17	19	CARH1760	✓		
CBR 1000 RR-R						
parafango ant. / front mudguard / guardabarros delantero / Vordere Kotflügel / フロント マッドガード	20	23	CARH2110	✓		
parafango post. / rear mudguard / guardabarros trasero / Hintere Kotflügel / リア マッドガード	20	23	CARH2120	✓		
parafango post. con copri catena / rear mudguard with chain cover / guardabarros trasero con cubre cadena Hinterer Kotflügel mit Kettenabdeckung / リアマッドガード (チェーンカバー付き)	20	23	CARH2121	✓		
coperchio pick up / pick up cover / tapa pick up / pick up Deckel / ピックアップ カバー	20	23	CARH2118			
coperchio frizione / clutch cover / guardabarros trasero / Kupplungs - Deckel / クラッチ カバー /	20	23	CARH2130			
coperchio alternatore / electric cover / tapa alternador / Lichtmaschine Deckel / ジェネレーター カバー	20	23	CARH2140			
protezioni telaio / frame protector / protección chasis / Rahmen Abdeckung / フレーム プロテクター	20	23	CARH2150	✓		
protezioni forcellone / swingarm protector / protección basculante / Schwingen Abdeckung / スイングアーム プロテクター	20	23	CARH2160	✓		

HONDA CB 1000 R
CARH7710HONDA CB 1000 R
CARH7720

COMPONENTI IN CARBONIO

CARBON PARTS - COMPONENTES CARBONO - CARBONTEILE - カーボンパーツ

KAWASAKI	Year		Code	AC	Code	Price
	from	to	SHINE		MATT	
NEW ZX 4 RR						
parafango ant. / front mudguard / guardabarros delantero / Vordere kotflügel / フロント マッドガード	24	24	CARK0410	✓		
parafango post. / rear mudguard / guardabarros trasero / Hintere kotflügel / リア マッドガード	24	24	CARK0420	✓		
protezioni telaio / frame protector / protección chasis / Rahmen Abdeckung / フレーム プロテクター	24	24	CARK0450	✓		
protezioni forcellone / swingarm protector / protección basculante / Schwingen Abdeckung / スイングアーム プロテクター	24	24	CARK0460	✓		
ZX6R / 636						
parafango ant. / front mudguard / guardabarros delantero / Vordere kotflügel / フロント マッドガード	09	18	CARK9610	✓		
parafango post. / rear mudguard / guardabarros trasero / Hintere kotflügel / リア マッドガード	09	21	CARK9520	✓		
coperchio frizione / clutch cover / guardabarros trasero / Kupplungs - Deckel / クラッチ カバー /	09	21	CARK9530			
coperchio alternatore / electric cover / tapa alternador / Lichtmaschine Deckel / ジェネレーター カバー	09	21	CARK9540			
coperchio pick up / pick up cover / tapa pick up / pick up Deckel / ビックアップ カバー	09	21	CARK9518			
protezioni telaio / frame protector / protección chasis / Rahmen Abdeckung / フレーム プロテクター	09	21	CARK9550	✓		
protezioni forcellone / swingarm protector / protección basculante / Schwingen Abdeckung / スイングアーム プロテクター	09	21	CARK9560	✓		
copri catena / chain cover / cubrecadena / Kette Abdeckung / チェーン カバー	09	21	CARK9512	✓		
ZX 636						
parafango ant. / front mudguard / guardabarros delantero / Vordere kotflügel / フロント マッドガード	24	24	CARK2410	✓		
parafango post. / rear mudguard / guardabarros trasero / Hintere kotflügel / リア マッドガード	24	24	CARK9520	✓		
coperchio frizione / clutch cover / guardabarros trasero / Kupplungs - Deckel / クラッチ カバー /	24	24	CARK9530			
coperchio alternatore / electric cover / tapa alternador / Lichtmaschine Deckel / ジェネレーター カバー	24	24	CARK9540			
coperchio pick up / pick up cover / tapa pick up / pick up Deckel / ビックアップ カバー	24	24	CARK9518			
protezioni telaio / frame protector / protección chasis / Rahmen Abdeckung / フレーム プロテクター	24	24	CARK9550	✓		
protezioni forcellone / swingarm protector / protección basculante / Schwingen Abdeckung / スイングアーム プロテクター	24	24	CARK9560	✓		
copri catena / chain cover / cubrecadena / Kette Abdeckung / チェーン カバー	24	24	CARK9512	✓		
ZX10R						
parafango ant. / front mudguard / guardabarros delantero / Vordere kotflügel / フロント マッドガード	11	15	CARK9610	✓		
parafango post. / rear mudguard / guardabarros trasero / Hintere kotflügel / リア マッドガード	11	15	CARK9620	✓		
copri catena / chain cover / cubrecadena / Kette Abdeckung / チェーン カバー	11	15	CARK9612			
coperchio frizione / clutch cover / guardabarros trasero / Kupplungs - Deckel / クラッチ カバー /	11	15	CARK9630			
coperchio alternatore / electric cover / tapa alternador / Lichtmaschine Deckel / ジェネレーター カバー	11	15	CARK9640			
coperchio pick up / pick up cover / tapa pick up / pick up Deckel / ビックアップ カバー	11	15	CARK9618	✓		
protezioni telaio / frame protector / protección chasis / Rahmen Abdeckung / フレーム プロテクター	11	15	CARK9650	✓		
protezioni forcellone / swingarm protector / protección basculante / Schwingen Abdeckung / スイングアーム プロテクター	11	15	CARK9660	✓		
ZX10R						
parafango ant. / front mudguard / guardabarros delantero / Vordere kotflügel / フロント マッドガード	16	23	CARK9810	✓		
parafango post. / rear mudguard / guardabarros trasero / Hintere kotflügel / リア マッドガード	11	23	CARK9620	✓		
copri catena / chain cover / cubrecadena / Kette Abdeckung / チェーン カバー	11	23	CARK9612			
coperchio frizione / clutch cover / guardabarros trasero / Kupplungs - Deckel / クラッチ カバー /	11	23	CARK9630			
coperchio alternatore / electric cover / tapa alternador / Lichtmaschine Deckel / ジェネレーター カバー	11	23	CARK9640			
coperchio pick up / pick up cover / tapa pick up / pick up Deckel / ビックアップ カバー	11	23	CARK9618	✓		
protezioni telaio / frame protector / protección chasis / Rahmen Abdeckung / フレーム プロテクター	16	23	CARK9850	✓		
protezioni forcellone / swingarm protector / protección basculante / Schwingen Abdeckung / スイングアーム プロテクター	11	15	CARK9660	✓		
ZX10R						
parafango ant. / front mudguard / guardabarros delantero / Vordere kotflügel / フロント マッドガード	17	23	CARK8010	✓		
parafango post. / rear mudguard / guardabarros trasero / Hintere kotflügel / リア マッドガード	17	23	CARK8020	✓		
coperchio frizione / clutch cover / guardabarros trasero / Kupplungs - Deckel / クラッチ カバー /	17	23	CARK8030			
coperchio alternatore / electric cover / tapa alternador / Lichtmaschine Deckel / ジェネレーター カバー	17	23	CARK8040			
coperchio pick up / pick up cover / tapa pick up / pick up Deckel / ビックアップ カバー	17	23	CARK8018			
frontalino copri strumenti / tachometer support cover / soportes relojes / Instrumenten Halterung / タコメーター サポート カバー	17	19	CARK8070	✓		
frontalino copri strumenti / tachometer support cover / soportes relojes / Instrumenten Halterung / タコメーター サポート カバー	20	23	CARK8071	✓		

■ END STOCK 廃盤

■ END STOCK 廃盤

MV AUGUSTA	Year		Code	Price	Code	Price
	from	to	SHINE		MATT	
B3 / F3 / RIVALE						
parafango ant. / front mudguard / guardabarros delantero / Vordere kotflügel / フロント マッドガード	12	19	CARM1010		CARM1010M	
parafango post. / rear mudguard / guardabarros trasero / Hintere kotflügel / リア マッドガード	12	19	CARM1020		CARM1020M	
copri catena / chain cover / cubrecadena / Kette Abdeckung / チェーン カバー	12	19	CARM1012		CARM1012M	

COMPONENTI IN CARBONIO
CARBON PARTS - COMPONENTES CARBONO - CARBONTEILE - カーボン パーツ



KAWASAKI Z900
CARK8010



KAWASAKI Z900
CARK8020



KAWASAKI Z900
CARK8070

! END STOCK 廃盤

! END STOCK 廃盤

SUZUKI	Year		Code	AC	Code	Price
	from	to	SHINE		MATT	
GSX-R 600 / 750						
parafango ant. / front mudguard / guardabarros delantero / Vordere kotflügel / フロント マッドガード	11	17	CARS6110	✓		
parafango post. / rear mudguard / guardabarros trasero / Hintere kotflügel / リア マッドガード	11	17	CARS6120	✓		
coperchio frizione / clutch cover / guardabarros trasero / Kupplungs - Deckel / クラッチ カバー /	11	17	CARS8030			
coperchio alternatore / electric cover / tapa alternador / Lichtmaschine Deckel / ジェネレーター カバー	11	17	CARS6040			
protezioni telaio / frame protector / protección chasis / Rahmen Abdeckung / フレーム プロテクター	11	17	CARS6150	✓		
protezioni forcellone / swingarm protector / protección basculante / Schwingen Abdeckung / スイングアーム プロテクター	11	17	CARS6160	✓		
GSX-R 1000						
parafango ant. / front mudguard / guardabarros delantero / Vordere kotflügel / フロント マッドガード	09	16	CARS6410	✓		
parafango post. / rear mudguard / guardabarros trasero / Hintere kotflügel / リア マッドガード	09	16	CARS6420	✓		
coperchio frizione / clutch cover / guardabarros trasero / Kupplungs - Deckel / クラッチ カバー /	09	16	CARS6430			
coperchio alternatore / electric cover / tapa alternador / Lichtmaschine Deckel / ジェネレーター カバー	09	16	CARS6440			
protezioni telaio / frame protector / protección chasis / Rahmen Abdeckung / フレーム プロテクター	09	16	CARS6450	✓		
protezioni forcellone / swingarm protector / protección basculante / Schwingen Abdeckung / スイングアーム プロテクター	09	16	CARS6460	✓		
GSX-R 1000 / R						
parafango ant. / front mudguard / guardabarros delantero / Vordere kotflügel / フロント マッドガード	17	22	CARS6510	✓	CARS6510M	
parafango post. / rear mudguard / guardabarros trasero / Hintere kotflügel / リア マッドガード	17	22	CARS6521	✓	CARS6521M	
coperchio frizione / clutch cover / guardabarros trasero / Kupplungs - Deckel / クラッチ カバー /	17	22	CARS6530		CARS6530M	
coperchio alternatore / electric cover / tapa alternador / Lichtmaschine Deckel / ジェネレーター カバー	17	22	CARS6540		CARS6540M	
protezioni telaio / frame protector / protección chasis / Rahmen Abdeckung / フレーム プロテクター	17	22	CARS6550	✓	CARS6550M	
protezioni forcellone / swingarm protector / protección basculante / Schwingen Abdeckung / スイングアーム プロテクター	17	22	CARS6560	✓	CARS6560M	
copri catena / chain cover / cubrecadena / Kette Abdeckung / チェーン カバー	17	22	CARS6512	✓	CARS6512M	
copri serbatoio / tank cover / tapa deposito / Tankdeckel / タンク カバー	17	22	CARS6529	✓	CARS6529M	
tubi airbox / racing airducts / tubos air box / Airbox Rohre / レーシング エアダクト	17	22	CARS6519	✓		

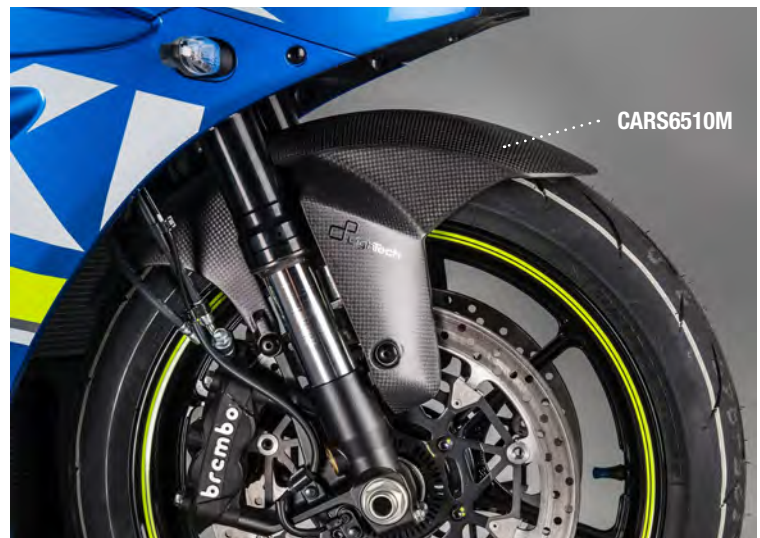

COMPONENTI IN CARBONIO

CARBON PARTS - COMPONENTES CARBONO - CARBONTEILE - カーボンパーツ

YAMAHA	Year		Code	AC	Code	Price
	from	to				
MT-09 / MT 09-Tracer						
parafango ant. / front mudguard / guardabarros delantero / Vordere kotflügel / フロント マッドガード	13	23	CARY8910	✓		
parafango post. / rear mudguard / guardabarros trasero / Hintere kotflügel / リア マッドガード	13	23	CARY8920	✓		
MT-10						
parafango ant. / front mudguard / guardabarros delantero / Vordere kotflügel / フロント マッドガード	16	21	CARY5010	✓		
parafango post. / rear mudguard / guardabarros trasero / Hintere kotflügel / リア マッドガード	16	21	CARY5020	✓		
copri catena / chain cover / cubrecadena / Kette Abdeckung / チェーン カバー	16	21	CARY5012	✓		
coperchio frizione / clutch cover / guardabarros trasero / Kupplungs - Deckel / クラッチ カバー /	16	21	CARY5130			
coperchio alternatore / electric cover / tapa alternador / Lichtmaschine Deckel / ジェネレーター カバー	16	21	CARY5140			
coperchio pick up / pick up cover / tapa pick up / pick up Deckel / ピックアップ カバー	16	21	CARY5018			
protezioni telaio / frame protector / protección chasis / Rahmen Abdeckung / フレーム プロテクター	16	21	CARY5050	✓		
protezioni forcellone / swingarm protector / protección basculante / Schwingen Abdeckung / スイングアーム プロテクター	16	21	CARY5060	✓		
R1						
parafango ant. / front mudguard / guardabarros delantero / Vordere kotflügel / フロント マッドガード	15	20	CARY5010	✓		
parafango post. / rear mudguard / guardabarros trasero / Hintere kotflügel / リア マッドガード	15	20	CARY5020	✓		
copri catena / chain cover / cubrecadena / Kette Abdeckung / チェーン カバー	15	20	CARY5012	✓		
coperchio frizione / clutch cover / guardabarros trasero / Kupplungs - Deckel / クラッチ カバー /	15	16	CARY5030			
coperchio frizione / clutch cover / guardabarros trasero / Kupplungs - Deckel / クラッチ カバー /	17	19	CARY5130			
coperchio alternatore / electric cover / tapa alternador / Lichtmaschine Deckel / ジェネレーター カバー	15	20	CARY5040			
coperchio pick up / pick up cover / tapa pick up / pick up Deckel / ピックアップ カバー	15	20	CARY5018			
protezioni telaio / frame protector / protección chasis / Rahmen Abdeckung / フレーム プロテクター	15	20	CARY5050	✓		
protezioni forcellone / swingarm protector / protección basculante / Schwingen Abdeckung / スイングアーム プロテクター	15	20	CARY5060	✓		
copri serbatoio / tank cover / tapa deposito / Tankdeckel / タンク カバー	15	19	CARY5029	✓		
R1						
parafango ant. / front mudguard / guardabarros delantero / Vordere kotflügel / フロント マッドガード	20	23	CARY5010	✓		
parafango post. / rear mudguard / guardabarros trasero / Hintere kotflügel / リア マッドガード	20	23	CARY5020	✓		
copri catena / chain cover / cubrecadena / Kette Abdeckung / チェーン カバー	20	23	CARY5012	✓		
coperchio frizione / clutch cover / guardabarros trasero / Kupplungs - Deckel / クラッチ カバー /	20	23	CARY5130			
coperchio alternatore / electric cover / tapa alternador / Lichtmaschine Deckel / ジェネレーター カバー	20	23	CARY5040			
coperchio pick up / pick up cover / tapa pick up / pick up Deckel / ピックアップ カバー	20	23	CARY5018			
protezioni telaio / frame protector / protección chasis / Rahmen Abdeckung / フレーム プロテクター	20	23	CARY5050	✓		
protezioni forcellone / swingarm protector / protección basculante / Schwingen Abdeckung / スイングアーム プロテクター	20	23	CARY5060	✓		
copri serbatoio / tank cover / tapa deposito / Tankdeckel / タンク カバー	20	23	CARY5129	✓		
R1-M						
parafango ant. / front mudguard / guardabarros delantero / Vordere kotflügel / フロント マッドガード	20	23	CARY5110	✓		
parafango post. / rear mudguard / guardabarros trasero / Hintere kotflügel / リア マッドガード	20	23	CARY5020	✓		
copri catena / chain cover / cubrecadena / Kette Abdeckung / チェーン カバー	20	23	CARY5012	✓		
copri serbatoio / tank cover / tapa deposito / Tankdeckel / タンク カバー	20	23	CARY5129	✓		
coperchio frizione / clutch cover / guardabarros trasero / Kupplungs - Deckel / クラッチ カバー /	20	23	CARY5130			
coperchio alternatore / electric cover / tapa alternador / Lichtmaschine Deckel / ジェネレーター カバー	20	23	CARY5040			
coperchio pick up / pick up cover / tapa pick up / pick up Deckel / ピックアップ カバー	20	23	CARY5018			
protezioni telaio / frame protector / protección chasis / Rahmen Abdeckung / フレーム プロテクター	20	23	CARY5050	✓		
protezioni forcellone / swingarm protector / protección basculante / Schwingen Abdeckung / スイングアーム プロテクター	20	23	CARY5060	✓		
protezioni serbatoio / tank protector / protección del tanque / Tankschutz / タンクプロテクター	20	23	CARY5190	✓		

YAMAHA	Year		Code	AC	Code	Price
	from	to				
YZF R6			SHINE		MATT	
parafango ant. / front mudguard / guardabarros delantero / Vordere kotflügel / フロント マッドガード	06	16	CARY9910	✓		
parafango post. / rear mudguard / guardabarros trasero / Hintere kotflügel / リア マッドガード	06	16	CARY9920	✓		
coperchio frizione / clutch cover / guardabarros trasero / Kupplungs - Deckel / クラッチ カバー /	06	16	CARY9930			
coperchio alternatore / electric cover / tapa alternador / Lichtmaschine Deckel / ジェネレーター カバー	06	16	CARY9940			
coperchio pick up / pick up cover / tapa pick up / pick up Deckel / ピックアップ カバー	06	16	CARY9918			
protezioni telaio / frame protector / protección chasis / Rahmen Abdeckung / フレーム プロテクター	06	16	CARY9950	✓		
protezioni forcellone / swingarm protector / protección basculante / Schwingen Abdeckung / スイングアーム プロテクター	06	16	CARY9960	✓		

YZF R6						
parafango ant. / front mudguard / guardabarros delantero / Vordere kotflügel / フロント マッドガード	17	22	CARY5010	✓		
copri catena / chain cover / cubrecadena / Kette Abdeckung / チェーン カバー	17	22	CARY9912	✓		
parafango post. / rear mudguard / guardabarros trasero / Hintere kotflügel / リア マッドガード	17	22	CARY9920	✓		
coperchio frizione / clutch cover / guardabarros trasero / Kupplungs - Deckel / クラッチ カバー /	17	22	CARY9930			
coperchio alternatore / electric cover / tapa alternador / Lichtmaschine Deckel / ジェネレーター カバー	17	22	CARY9940			
coperchio pick up / pick up cover / tapa pick up / pick up Deckel / ピックアップ カバー	17	22	CARY9918			
protezioni telaio / frame protector / protección chasis / Rahmen Abdeckung / フレーム プロテクター	17	22	CARY9951	✓		
protezioni forcellone / swingarm protector / protección basculante / Schwingen Abdeckung / スイングアーム プロテクター	17	22	CARY9961	✓		
copri serbatoio / tank cover / tapa deposito / Tankdeckel / タンク カバー	17	22	CARY9929	✓		
protezioni serbatoio / tank protector / protección del tanque / Tankschutz / タンクプロテクター	17	22	CARY9990	✓		

NEW

YZF R7						
parafango ant. / front mudguard / guardabarros delantero / Vordere kotflügel / フロント マッドガード	22	23	CARY0710	✓		
parafango post. / rear mudguard / guardabarros trasero / Hintere kotflügel / リア マッドガード	22	23	CARY0720	✓		
protezioni telaio / frame protector / protección chasis / Rahmen Abdeckung / フレーム プロテクター	22	23	CARY0750	✓		
protezioni forcellone / swingarm protector / protección basculante / Schwingen Abdeckung / スイングアーム プロテクター	22	23	CARY0760	✓		

T-MAX 500 / 530						
parafango ant. / front mudguard / guardabarros delantero / Vordere kotflügel / フロント マッドガード	08	14	CARY4610	✓	CARY4610M	
parafango ant. / front mudguard / guardabarros delantero / Vordere kotflügel / フロント マッドガード	15	16	CARY4710	✓	CARY4710M	
protezioni forcellone / swingarm protector / protección basculante / Schwingen Abdeckung / スイングアーム プロテクター	12	16	CARY4660	✓	CARY4660M	
copri cinghia / belt protector / cubre correa / Kettenschutz / ベルトプロテクター	12	16	CARY4612	✓	CARY4612M	

T-MAX 530 / 560						
copri cinghia superiore / upper belt cover / cubre correa superior en carbono / Oberer Kettenschutz / ベルトカバー (上側)	17	22	CARY4912	✓	CARY4914M	
copri cinghia inferiore / lower belt cover / cubre correa inferior en carbono / Unterer Kettenschutz / ベルトカバー (下側)	17	22	CARY4914	✓	CARY4914M	

RACING						
Pinna protezione catena / Chain protection / Protector para cadena / Kettenabdeckung / 汎用 チェーン プロテクター			CAR001			
Convogliatori aria per raffreddamento pinze freno / Air conveyors for brake caliper Toma de aire para enfriamiento de la pinza de freno / Bremssattelförderer / ブレーキキャリアー用 エアダクト			CAR007			

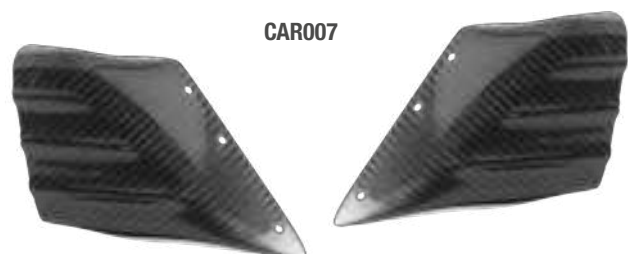

CAR007







GRIGLIE RADIATORE
RADIATOR GUARDS
PROTECTORES DE RADIADOR
KÜHLERSCHUTZGITTER
ラジエーターガード

GRIGLIE RADIATORE

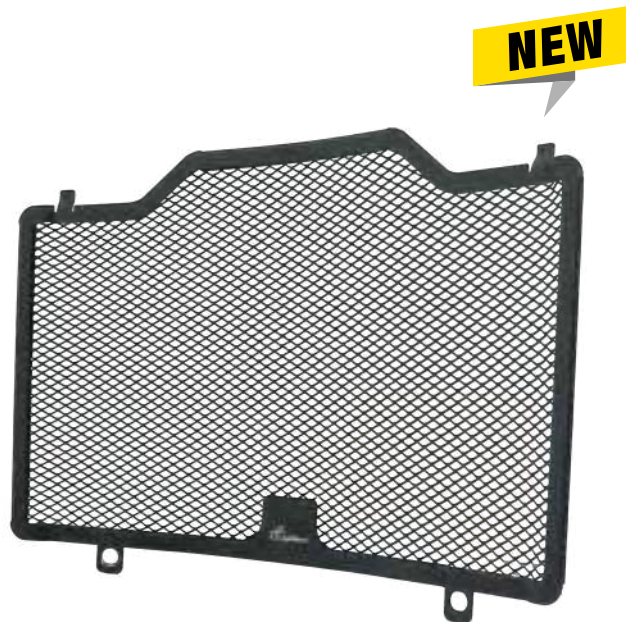
RADIATOR GUARDS - PROTECTORES DE RADIADOR - KÜHLERSCHUTZGITTER - ラジエーター ガード



	Year		Water	Oil	Code	Color	Price
	from	to					
APRILIA							
RS 660	21	24	✓		GPRAP001	●	
RS 660 / 660 Factory	21	24	✓		GPRAP001	●	
RSV4 Factory	09	14	✓		GPRAP002	●	
RSV4 R	09	14	✓		GPRAP002	●	
RSV4 RF	15	18	✓		GPRAP002	●	
RSV4 RR	15	19	✓		GPRAP002	●	
RSV4 1100 Factory	20	24	✓		GPRAP002	●	
Tuono V4 1000 R	11	14	✓		GPRAP002	●	
Tuono V4 1100 Factory	15	18	✓		GPRAP002	●	
Tuono V4 1100 Factory (E4 / E5)	19 (E4)	24	✓		GPRAP002	●	
Tuono V4 1100 R	15	20	✓		GPRAP002	●	
Tuono V4 1100 (E5)	21	24	✓		GPRAP002	●	

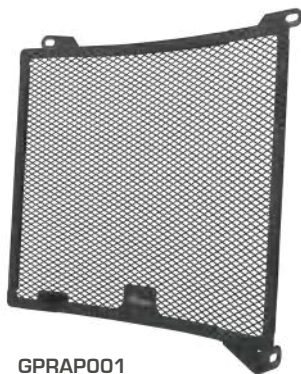



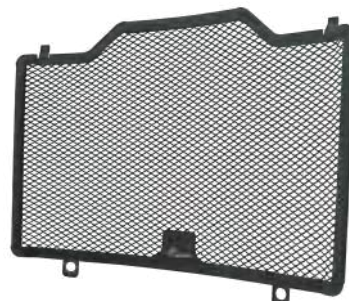

GPRBM001



GPRDU001

	Year		Water	Oil	Code	Color	Price
	from	to					
BENELLI							
TRK 702					GPRBN001	●	
TRK 800					GPRBN002	●	
BMW							
S1000 RR	20	K67	✓		GPRBM001	●	
GS 1300	24				GPRBM002	●	
DUCATI							
DesertX 937	22	24	✓		GPRDU001	●	
Hypermotard 939 / 939 SP	16	18		✓	GPRDU002	●	
Hypermotard 950 / 950 SP	19	24		✓	GPRDU002	●	
Multistrada 1260 S PIKES PEAK	18	20	✓		GPRDU003	●	
Multistrada 1260 S	18	20	✓		GPRDU003	●	
Multistrada 1260	18	20	✓		GPRDU003	●	
Multistrada 950 S	19	21	✓		GPRDU003	●	
Multistrada 950 V2 / V2 S	22	23	✓		GPRDU003	●	
Multistrada 950	17	21	✓		GPRDU003	●	
Multistrada V4 PIKES PEAK	22	24		✓	GPRDU004	●	
			✓		GPRDU005	●	
Multistrada V4 RALLY	23	23		✓	GPRDU004	●	
			✓		GPRDU005	●	
Multistrada V4 / V4 S	21	24	✓		GPRDU004	●	
Multistrada V4 / V4 S	21	24	✓		GPRDU005	●	

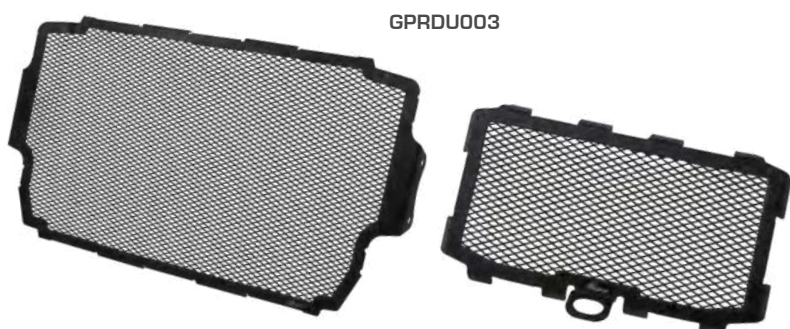



GPRDU003



GPRDU004

GRIGLIE RADIATORE

RADIATOR GUARDS - PROTECTORES DE RADIADOR - KÜHLERSCHUTZGITTER - ラジエーター ガード

	Year		Water	Oil	Code	Color	Price
	from	to					
DUCATI							
Streetfighter V4 / V4 S	20	24	✓		GPRDU006	●	
Streetfighter V4 SP2	22	23	✓		GPRDU006	●	
Streetfighter V2	22	24	✓		GPRDU007	●	
Superbike 1199 Panigale R	13	17	✓		GPRDU008	●	
Superbike 1199 Panigale S	12	14	✓		GPRDU008	●	
Superbike 1199 Panigale	12	14	✓		GPRDU008	●	
Superbike 1199 Superleggera	14		✓		GPRDU008	●	
Superbike 1299 Panigale S	15	17	✓		GPRDU008	●	
Superbike 1299 Panigale	15	17	✓		GPRDU008	●	
Superbike 899 Panigale	13	15	✓		GPRDU008	●	
Superbike 959 Panigale	16	19	✓		GPRDU008	●	
Superbike 955 Panigale V2	20	24	✓		GPRDU008	●	
Superbike Panigale V4 R	19	24	✓		GPRDU006	●	
Superbike Panigale V4 S	18	24	✓		GPRDU006	●	
Superbike Panigale V4	18	24	✓		GPRDU006	●	
Superbike Superleggera V4	20	21	✓		GPRDU006	●	
HONDA							
Africa Twin			✓		GPRH001	●	
KTM							
Duke 390	24		✓		GPRKT001	●	
Duke 790	18	23	✓		GPRKT002	●	
Duke 890	20	23	✓		GPRKT002	●	
Duke 990	24		✓		GPRKT003	●	
Superduke 1290	20	23	✓		GPRKT004	●	
Superduke 1390	24		✓		GPRKT005	●	
TRIUMPH							
Street Triple 765	17	23	✓		GPRT001	●	
Speed triple 1200 RS	21	23	✓		GPRT002	●	
YAMAHA							
Tracer 7 / 7 GT	20	24	✓		GPRYA001	●	
MT-07	21	24	✓		GPRYA002	●	
MT-09	21	24	✓		GPRYA003	●	
Tenere 700	19	23	✓		GPRYA004	●	
Tracer 9 / 9GT / 9GT+	21	24	✓		GPRYA005	●	



GPRDU005

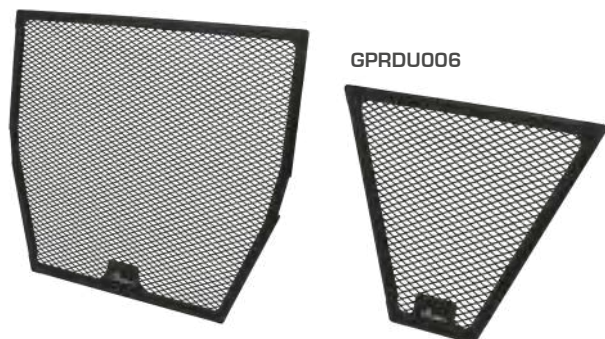

GPRDU006



CAVALLETTI
STANDS
CABALLETES
MOTORRADSTÄNDER
スタンド

RACING & BOX



CARBON STANDS

kg 2,1

Available colours: ●

Cavalletto posteriore regolabile in carbonio **con forchette**

Carbon rear stand **with forks**

Cabalete trasero de carbono **con horquillas**

Hinterrad: Carbonständer **mit Gabelaufnahme**

カーボンリアスタンド V字フックタイプ

RSC004F

Cavalletto posteriore regolabile in carbonio **con rulli**

Carbon rear stand **with rollers**

Cabalete trasero de carbono **con rodillos**

Hinterrad: Carbonständer **mit Rollen**

カーボンリアスタンド ローラーブロックタイプ

RSC004R

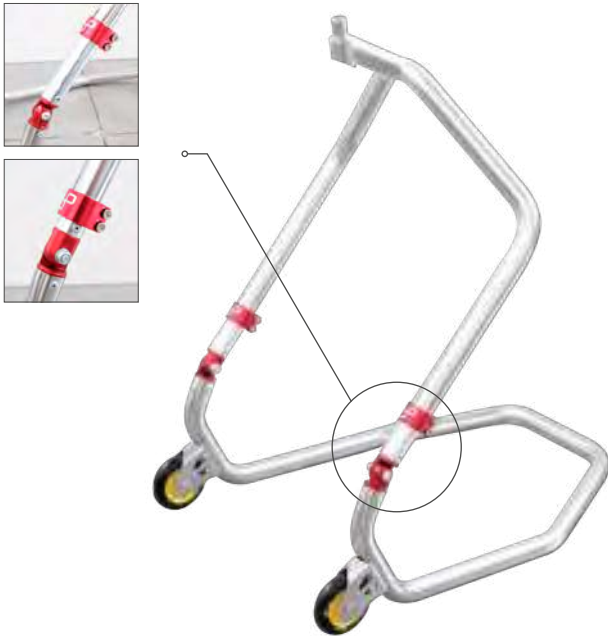

STAINLESS STEEL STANDS

Cavalletto anteriore centrale in acciaio inossidabile
Stainless steel front stand - Under triple clamp type paddock stand
Caballete delantero central de acero inoxidable
Vorderer Ständer aus Edelstahl
ステンレス フロントトリプル ツリー スタンド

RSS001

Perno inox per cavalletto
Stainless steel pin for stand
Adaptador inox para caballete
Bolzen für Ständer aus Edelstahl
スタンド用ステンレス ピン



STAINLESS STEEL PIN	∅	Code	Price
RSS001	12,7	PIN001	
RSS001 - BMW S1000RR	15,7	PIN002	
RSS001 - Aprilia RSV4	19,8	PIN003	
RSS001 - Kawasaki Ninja 400	22,0	PIN004	
RSS001 - Kawasaki 400 ZX 4RR	24,0	PIN005	
RSS001 - Kawasaki ZX10R / ZX6R / Z900	27,7	PIN006	
RSS001 - Yamaha R1 / R6	16,5	PIN007	
RSS001 - Yamaha R3	17,2	PIN008	
RSS001 - Suzuki GSXR1000	15,9	PIN009	
RSS001 - Yamaha R7	20,1	PIN010	
RSS001 - Ducati Panigale V4	27,7	PIN011	
RSS001 - Kawasaki ZX10R	15,0	PIN012	



STAINLESS STEEL STANDS

Cavalletto anteriore in acciaio inox, **regolabile in altezza**
Stainless steel **height adjustable** front stand
Caballete frontal de acero inoxidable **ajustable en altura**
Höhenverstellbarer Vorderständer aus Edelstahl
ステンレス製フロントスタンド (高さ調節可能)

RSS007

CAVALLETTI ACCIAIO INOSSIDABILE

STAINLESS STEEL STANDS - CABALLETES DE ACERO INOXIDABLE - EDELSTAHLSTÄNDER - ステンレス スタンド



STAINLESS STEEL STANDS

kg 2,6



Cavalletto posteriore in acciaio inossidabile a 2 ruote con forchette
 Stainless steel rear stand with 2 wheels and forks
 Caballete trasero de acero inoxidable con 2 ruedas con horquillas
 Hinterrad: Ständer aus aus Edelstahl mit Gabelaufnahme (2 Rad)
 ステンレス リアスタンド V字フック付

RSS005F



Cavalletto posteriore in acciaio inossidabile a 2 ruote rulli
 Stainless steel rear stand with 2 wheels and rollers
 Caballete trasero de acero inoxidable con 2 ruedas con rodillo
 Hinterrad: Ständer aus aus Edelstahl mit Rollen (2 Rad)
 ステンレス リアスタンド ローラーブロック付

RSS005R



**METAL STANDS**

Available colours: ●

Cavalletto anteriore in ferro
Iron front stand
Caballete delantero hierro
Vorderrad: Ständer aus Eisen
スチール フロントスタンド

RSF008

**METAL STANDS**

Available colours: ●

Cavalletto anteriore in ferro con attacco sotto pinze freno
Iron front stand with attachment under brake calipers
Caballete delantero en hierro con acople bajo la pinza de freno
Vorderradständer aus Eisen mit Halterung unter dem Bremssattel
スチール フロントスタンド

RSF042





METAL STANDS

kg 3,0

Cavalletto posteriore in ferro a 2 ruote con forchette
 Iron rear stand with 2 wheels and forks
 Caballete trasero en hierro con 2 ruedas con horquillas
 Hinterrad: Ständer aus Eisen mit Gabelaufnahme (2 Rad)
 スチールリアスタンドV字フックタイプ

RSF036



METAL STANDS

kg 3,1

Cavalletto posteriore in ferro a 2 ruote con forchette
 Iron rear stand with 2 wheels and forks
 Caballete trasero en hierro con 2 ruedas con horquillas
 Hinterrad: Ständer aus Eisen mit Gabelaufnahme (2 Rad)
 スチールリアスタンドV字フック付

RSF045F

Cavalletto posteriore in ferro a 2 ruote con pattini
 Iron rear stand with 2 wheels and sliding blocks
 Caballete trasero en hierro con 2 ruedas anclaje basculante
 Hinterrad: Ständer aus Eisen mit Gleitbackenaufnahme (2 Rad)
 スチールリアスタンドL字ブロック付

RSF045P

Cavalletto posteriore in ferro a 2 ruote rulli
 Iron rear stand with 2 wheels and rollers
 Caballete trasero en hierro con 2 ruedas con rodillo
 Hinterrad: Ständer aus Eisen mit Rollen (2 Rad)
 スチールリアスタンドローラーブロック付

RSF045R



METAL STANDS

kg 2,9

Cavalletto anteriore in ferro
 Iron front stand
 Caballete delantero en hierro
 Vorderrad: Ständer aus Eisen
 スチールフロントスタンド

RSF22



METAL STANDS

kg 4 - 4,5

Cavalletto posteriore in ferro con forchette
 Iron rear stand with forks
 Caballete trasero en hierro con ruedas con horquillas
 Hinterrad: Ständer aus Eisen mit Gabelaufnahme
 スチールリアスタンドV字フック付

RSF21F

Cavalletto posteriore in ferro con pattini
 Iron rear stand with sliding blocks
 Caballete trasero en hierro con ruedas anclaje basculante
 Hinterrad: Ständer aus Eisen mit Gleitbackenaufnahme
 スチールリアスタンドL字ブロック付

RSF21P

Cavalletto posteriore in ferro con rulli
 Iron rear stand with rollers
 Caballete trasero en hierro con ruedas con rodillo
 Hinterrad: Ständer aus Eisen mit Rolle
 スチールリアスタンドローラーブロック付

RSF21R



METAL STANDS

Available colours: ●

Cavalletto posteriore monobraccio (senza perno)

Iron one armed rear stand (without pin)

Caballete trasero monobrazo en hierro (sin adaptador caballete)

Einarmständer hinten aus Eisen (ohne Bolzen)

片持ちスイングアーム用 スチールリアスタンド (アダプターは別売)

RSF046

Perno per cavalletto monobraccio in ferro
Pin for iron one armed rear stand
Adaptador caballete monobrazo en hierro
Bolzen für Monoarmig Einarmständer aus Eisen
片持ちスイングアーム用 スチールリアスタンド ピン

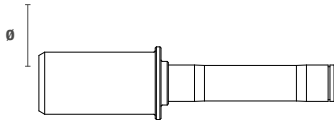

ø pin	Code	Price
42,7	RSF26	
28,4	RSF27	
26,8	RSF28	
40,6	RSF29	
25,7	RSF30	
53,5	RSF37	
18,0	RSF38	
27,7	RSF39	

Applicazioni perni per cavalletti monobraccio

Pins application list for one armed rear stand

Lista de aplicación de adaptadores para caballete monobrazo

Bolzen-Anwendungsliste für Einarmständer

片持ちスイングアーム用ピン適合リスト

	ø	Code
DUCATI		
848 / 848 EVO / 748	25,7	RSF30
1098 / 1198	40,6	RSF29
Panigale 1199 / 1299 / V4 / V2	40,6	RSF29
996 / 998	25,7	RSF30
S2R / S4R	25,7	RSF30
Monster 796	25,7	RSF30
Monster 1100	25,7	RSF30
Monster 1200 / 1200R	40,6	RSF29
Multistrada 1100	25,7	RSF30
Multistrada 1200	40,6	RSF29
Hypermotard 796/1100/821/939/959/950	25,7	RSF30
Streetfighter 848 / 1100	25,7	RSF30
Streetfighter 1098 S	40,6	RSF29
Streetfighter V2 / S	40,6	RSF29
Streetfighter V4 / S	40,6	RSF29
Diavel	40,6	RSF29
HONDA		
CB 1000 R (2008 - 2017)	28,4	RSF27
CB 1000 R (2018 - 2020)	18,0	RSF38
CB 1000 R (2021 -)	28,4	RSF27
VFR 800	28,4	RSF27
KTM		
Superduke 1290 R	27,7	RSF39
MV		
Brutale	42,7	RSF26
F4 / F3	42,7	RSF26
TRIUMPH		
Speed Triple 1050	26,8	RSF28
Speed Triple RS 1200	40,6	RSF29



CAVALLETTI METALLO

METAL STANDS - CABALLETES DE METAL - METALLSSTÄNDER - スタンド



METAL STANDS

kg 3,6



Cavalletto componibile posteriore in ferro a **4 ruote con forchette**
 Modular iron rear stand with **4 wheels and forks**
 Caballete trasero modular en hierro con **4 ruedas con horquillas**
 Hinterrad: Modular Ständer aus Eisen mit **Gabelaufnahme (4 Rad)**
 組み立て式 4輪 スチール リアスタンド V字フック付

RSF039F



Cavalletto componibile posteriore in ferro a **4 ruote con pattini**
 Modular iron rear stand with **4 wheels and sliding blocks**
 Caballete trasero modular en hierro con **4 ruedas anclaje basculante**
 Hinterrad: Modular Ständer aus Eisen mit **Gleitbackenaufnahme (4 Rad)**
 組み立て式 4輪 スチール リアスタンド L字ブロック付

RSF039P



Cavalletto componibile posteriore in ferro a **4 ruote rulli**
 Modular iron rear stand with **4 wheels and rollers**
 Caballete trasero modular en hierro con **4 ruedas con rodillo**
 Hinterrad: Modular Ständer aus Eisen mit **Rollen (4 Rad)**
 組み立て式 4輪 スチール リアスタンド ローラーブロック付

RSF039R

Ricambi per cavalletti

Stands spare parts - Recambios para caballetes - Recambios para caballetes - スタンドスペアパーツ



Forchette
 Forks
 Horquillas
 Gabelaufnahme
 V字フック

RSF23

for pair



Pattini
 Sliding blocks
 Anclaje basculante
 Gleitbackenaufnahme
 L字ブロック /

RSF24

for pair



Rulli
 Rollers
 Rodillo
 Rollen
 ローラーブロック

RSF25

for pair



Ruote
 Wheels
 Ruedas
 Räder
 ホイール

RW001

for pair



BOX ACCESORIES

Dimension: L1340 x P450 H1400

Carrello porta cerchi in acciaio inossidabile
Stainless steel rims carrier
Carro porta llantas de acero inoxidable
Felgenständer aus Edelstahl
アルミニウム ホイール キャリア

RSS004



BOX ACCESORIES

Cavalletto porta fusto benzina
Fuel drum support
Caballete porta deposito de gasolina
Ständer für Benzinbehälter
燃料ドラム用スタンド

RSS006

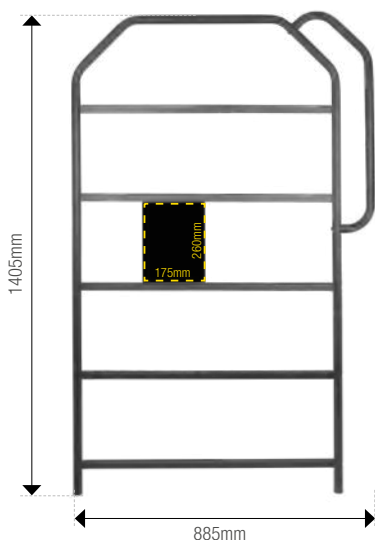

BOX ACCESORIES

Pitboard in alluminio verniciato nero
Aluminium pitboard - black painted
Pitboard en acero inox
Pitboard aus Aluminium, schwarz lackiert
アルミ ピットボード ブラック

TTG004



Completa di **50 tabelle** senza lettere e cifre
With **50 tables** without letters and numbers
Con **50 cuadros** sin letras y números
Tafel mit **50 Plätzen** ohne Schriftzeichen und Zahlen
50 レターボード付 (番号・文字なし)



Tabella in PVC (minimo ordinabile 10 pz.)
PVC time table (minimum required 10 pcs)
Tabla en pvc (pedido mínimo 10 piezas)
Tafel aus PVC (Mindestbestellmenge 10 St.)
レターボード (最低枚数10枚よりご注文頂けます)

TTG004-08

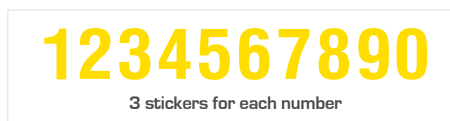

+



Kit adesivi pitboard (totale 38 pezzi)
Stickers kit for pitboard (numbers and letters: 38 pcs)
Adhesivos pizarra (total 38 piezas)
Kit Aufkleber für Pitboard (Buchstaben und Zahlen, insgesamt 38 St.)
ピットボード用ステッカーキット (38枚入り)

STK087

SERBATOIO RIFORMIMENTO RAPIDO

FAST FUEL CANISTER - DEPOSITO DE LLENADO RAPIDO - SCHNELL TANKANLAGE - クイックフューエルチャージャー



	Code	fuel canister colour	Price
5 litres	SER01	black	574,70
10 litres	SER02	black	574,70



Con foro centrato
With central hole
Con agujero central
Mit zentriertem Loch
センターホール用

	Code	fuel canister colour	Price
5 litres	SER04	black	574,70
10 litres	SER05	black	574,70



Con foro decentrato
With not central hole
Con agujero descentrado
Mit ausenmittigem Loch
オフセットホール用



SAPONETTE
KNEE SLIDERS
DESLIZADORES
KNIESCHLEIFER
ニー スライダー

SAPONETTE

KNEE SLIDERS - DESLIZADORES - KNIESCHLEIFER - ニー スライダー

Renzi Corse
Simone Corsi

Aeroslider

SAP002

Available colours: ● ○

for pair



Rain

SAPR001

Available colours: ●

for pair



Ricambio - Spare part - Recambio - Ersatzteile - スペア パーツ

RSAPR001



Filler

SAPF

Available colours: ● ●

for pair





Nuke

SAPN

Available colours: ●

for pair



Dropper

SAPDRO

Available colours: ● ● ○ ● ●

for pair



Neoprene per sella
Neoprene for racing seat
Espuma asiento
Neopren für Sitzbank
レーシングシート用 ネオプレン

NSR01

Dimension: 330 x 330 x 15 mm

for piece



Team SpeedUp
Fermin Aldeguer



Team SpeedUp
Alonso López



Team SpeedUp
Fermín Aldeguer

APPAREL
by Lightech





T-Shirt

AVAILABLE SIZES

	Code
XXS	TSH001
XS	TSH002
S	TSH003
M	TSH004
L	TSH005
XL	TSH006
XXL	TSH007
XXXL	TSH008



Felpa con cappuccio
Hoodie
Sudadera con capucha
Kapuzen Sweat-shirt
パーカー/トレーナー

AVAILABLE SIZES

	Code
XXS	HDS001
XS	HDS002
S	HDS003
M	HDS004
L	HDS005
XL	HDS006
XXL	HDS007
XXXL	HDS008



Capellino da paddock
Paddock cap
Gorra de Paddock
Paddockcap
Paddock cap

BSC001



Team SpeedUp
Fermin Aldeguer

Condizioni generali di vendita

PREZZI

I prezzi indicati nel catalogo sono tasse escluse.

TRASPORTO

Il trasporto dei nostri prodotti avviene tramite corriere e le spese di trasporto sono addebitate in fattura.

TEMPI E MODALITÀ DI CONSEGNA

La consegna dei prodotti viene normalmente assicurata entro 2/3 giorni dal ricevimento dell'ordine per l'Italia e pianificata nel resto del Mondo in base alla disponibilità del prodotto ed alle esigenze del Cliente/Distributore in accordo con Lightech. Lightech© viene distribuita in tutto in tutto il Mondo tramite la propria rete vendita.

RESO MERCE

Nella remota eventualità che il cliente riceva un prodotto che presenti difettosità o anomalie rispetto a quanto ordinato, il cliente dovrà entro 5 gg. lavorativi dalla data di ricezione merce informare il Servizio Clienti Lightech all'indirizzo mail sales@lightech.it per ricevere istruzioni dettagliate sulla modalità dell'eventuale reso prodotto e relativa sostituzione/nota di accredito.

MINIMO D'ORDINE

L'importo minimo dell'ordine deve essere uguale o maggiore di € 70 al netto degli sconti e spese accessorie, fatto salvo diverse le condizioni accordate con Lightech al momento della stipula del contratto.

MARCHI

I seguenti marchi registrati con i nomi: Aprilia®, BMW®, Ducati®, Honda®, Kawasaki®, Mv Agusta®, Suzuki®, Triumph®, Yamaha® sono di proprietà delle rispettive Case e vengono qui utilizzati a solo titolo descrittivo.

AGGIORNAMENTI AL CATALOGO

Lightech si riserva la facoltà di apportare aggiornamenti migliorativi ai prodotti ed al loro aggiornamento applicativo in qualsiasi momento e senza preavviso.

AVVERTENZE

I prodotti Lightech® sono stati progettati e realizzati per l'utilizzazione in ambiti agonistici. Lightech® non si assume pertanto alcuna responsabilità per un eventuale uso non corretto e responsabile dei propri prodotti.

INFORMAZIONE SUI PRODOTTI

Tutti gli articoli inseriti nel catalogo realizzati in leghe leggere vengono prodotti in Italia presso gli stabilimenti della Lightech.

Tutte le fotografie, le informazioni e le schede tecniche che illustrano i prodotti e le loro caratteristiche tecniche, sono di proprietà esclusiva della Lightech srl.

CONTROVERSIE E RESPONSABILITÀ

Le presenti condizioni generali di vendita sono regolate dalle leggi Italiane. Per qualsiasi controversia relativa alla validità, interpretazione o esecuzione delle medesime, la competenza territoriale è quella della città di Treviso in Italia.

Sales conditions

PRICES

The prices on the catalogue are in € currency, VAT excluded.

TRANSPORT

The transport is by express courier and shipping costs are charged in the invoice.

DELIVERY TIMES AND TERMS

Normally delivery times are within 2/3 working days from the receipt of the order for Italy. For the rest of the World, delivery times are planned based on product availability and the needs of Dealer / Distributor in agreement with LighTech. Lightech® is distributed worldwide through its own sales network.

RETURNS GOODS

In the event that the customer receives a product that has defects or anomalies with respect to what was ordered, the customer must inform LighTech Customer Service within 5 working days by writing to sales@lightech.it providing details on the goods ordered, invoice number and reasons for complaint, along with pictures whenever possible.

The customer will receive detailed information on terms and conditions for the possible return of the product and for its replacement or credit note.

MINIMUM ORDER

The minimum order amount must be equal to or greater than € 70 net of discounts, taxes and shipping costs, unless otherwise agreed with Lightech at the time of signing the contract.

TRADEMARK

Aprilia®, BMW®, Ducati®, Honda®, Kawasaki®, Mv Agusta®, Suzuki®, Triumph®, Yamaha® are registered Trademarks, here used only as a reference.

CATALOG UPDATES

Lightech® reserves the right to make improvements to the products and their applications at any time and without notice.

WARNINGS

LighTech® products have been designed and manufactured for agonistic use. Lightech© is therefore not responsible for any improper use of its products.

PRODUCT INFORMATION

All LighTech products included in the catalog are made of light alloys and are produced in Italy at LighTech factories.

Each photos and information present in the catalog are owned by LighTech srl. All rights reserved.

DISPUTES AND LIABILITY

These general sales conditions are governed by Italian laws. For any dispute relating to the validity, interpretation or execution of the same, the territorial jurisdiction is that of the city of Treviso in Italy.

Condiciones general de venta

PRECIOS

Los precios que figuran en catalogo son en EURO sin iva.

TRANSPORTE

El transporte de nuestros productos se realiza por agencia de transportes y los costos de transporte se cargan en factura.

TIEMPO DE ENTREGA

La entrega de los productos normalmente se garantiza dentro de 2/3 días desde la recepción del pedido para Italia y se planifica en el resto del mundo en función de la disponibilidad del producto y las necesidades del cliente / distribuidor de acuerdo con Lightech. Lightech® se distribuye en todo el mundo a través de su propia red de ventas.

DEVOLUCION MERCANCIA

En el caso remoto de que el cliente reciba un producto que tenga defectos o anomalías con respecto a lo pedido, el cliente debe informar al Servicio de atención al Cliente de Lightech por email (sales@lightech.it) dentro de los 5 días hábiles a partir de la fecha de recepción de los productos para recibir instrucciones detalladas sobre la devolución del producto y posterior cambio o abono.

PEDIDO MÍNIMO

El importe mínimo del pedido debe ser igual o mayor a 70 € netos de descuentos y costes complementarios, salvo pacto en contrario con Lightech en el momento del acuerdo comercial.

MARCAS

Las siguientes marcas registradas con el nombre de: Aprilia®, BMW®, Ducati®, Honda®, Kawasaki®, Mv Agusta®, Suzuki®, Triumph®, Yamaha® son propiedad de sus respectivas empresas, y son solo utilizados a efecto descriptivo.

VARIACIONES CATALOGO

Lightech® se reserva el derecho de realizar mejoras en los productos y las actualizaciones de sus aplicaciones en cualquier momento y sin previo aviso.

ADVERTENCIA

Los productos Lightech® han sido diseñados y fabricados para su uso en competición o circuito. Por lo tanto, Lightech® no asume ninguna responsabilidad por el uso incorrecto e irresponsable de sus productos.

INFORMACION DEL PRODUCTO

Todos los artículos incluidos en el catálogo están hechos de aleaciones ligeras y se producen en Italia en las fábricas de Lightech.

Todas las fotografías, información y hojas técnicas que ilustran los productos y sus características técnicas son propiedad exclusiva de Lightech srl.

DISPUTAS Y RESPONSABILIDADES

Estas condiciones generales de venta se rigen por las leyes italianas. Para cualquier disputa relacionada con la validez, interpretación o ejecución de la misma, la jurisdicción territorial es la de la ciudad de Treviso en Italia.

Geschäftsbedingungen

PREISE

Die im Katalog genannten Preise sind in Euro ohne MwSt.

TRANSPORT

Der Transport erfolgt mit Spediteure und die Transportkosten werden in Rechnung gestellt.

LIEFERUNGEN

Die Lieferung der Produkte wird normalerweise innerhalb von 2/3 Tagen nach Eingang der Bestellung in Italien erfolgen, und im Rest der Welt auf der Grundlage der Verfügbarkeit des Produktes und der Bedürfnisse des Dealers in Absprache mit Lightech geplant. Lightech® wird weltweit über ein eigenes Vertriebsnetz vertrieben.

ZURÜCKGEBEBENE WAREN

Für den Fall, dass der Kunde ein Produkt erhält, das Mängel oder Schäden ausweist und nicht der Bestellung entspricht, muss er den Lightech-Kundendienst innerhalb von 5 Arbeitstagen ab dem Datum des Wareneingangs unter der E-Mail-Adresse sales@lightech.it informieren, um detaillierte Anweisungen über die Produktrückgabe zu erhalten und der damit verbundenen Ersatz- / Gutschrift zu bekommen.

MINDESTBESTELLWERT

Der Mindestbestellbetrag muss gleich oder höher 70 € netto Warenwert und Nebenkosten betragen, sofern mit Lightech zum Zeitpunkt der Vertragsunterzeichnung nichts anderes vereinbart wurde.

MARKEN:

Die folgenden registrierten Markennamen: Aprilia®, BMW®, Ducati®, Honda®, Kawasaki®, Mv Agusta®, Suzuki®, Triumph®, Yamaha® sind Eigentum der jeweiligen Hersteller und werden nur als Erkennung und Identifizierung verwendet.

ÄNDERUNGEN IM KATALOG:

Lightech® behält sich das Recht vor, Verbesserungen an den Produkten und deren Anwendungsaktualisierungen ohne vorherige Vorankündigung vorzunehmen.

ZUR BEACHTUNG:

Lightech® Produkte werden zur Verwendung im Motorradsport hergestellt. Lightech übernimmt keiner Haftung für nicht korrekten Einbau, bzw. Anbau seiner Produkte.

INFORMATIONEN ÜBER DAS PRODUKT

Alle im Katalog enthaltenen Artikel bestehen aus Leichtmetallen und werden in Italien in den Werken von Lightech hergestellt.

Alle Fotos, Informationen und technischen Datenblätter, die die Produkte und ihre technischen Eigenschaften betreffen, sind das ausschließliche Eigentum von Lightech srl.

STREITIGKEITEN UND VERANTWORTUNG

Diese Geschäftsbedingungen werden von italienischen Gesetzen geregelt. Für Streitigkeiten in Bezug auf seine Gültigkeit, Interpretierung oder Vollstreckung, ist der Gerichtshof von Treviso zuständig.

このカタログに関する注意事項

価格についてこのカタログに記載されている価格は、すべて税別価格です。ご注意ください。

返品について 製品の返品は、受け取り後5日以内の製品不良に限り、お受けいたします。それ以外につきましては、一切返品対象外となります。もし製品に不良がございましたら、電話、FAX、またはE-MAIL (info@imotorcycle.jp)にてご連絡ください。その際は、製品の詳細や納品書等を、あらかじめご用意いただけますよう、よろしくお願いいたします。

商標マーク このカタログで使用されている以下のロゴは参考ロゴマークですので、ご注意ください。AEE®, Aprilia®, Benelli®, Beta®, BMW®, Ducati®, Ga-laxy®, Go Pro®, Guzzi®, Honda®, Husqvarna®, iPhone®, Kawasaki®, KTM®, Magura®, Mv Agusta®, Nilox®, Sherco®, Suzuki®, Tecnoglobe®, TM®, Triumph®, Yamaha® このカタログで使用している商品は、本カタログ用に撮影したものです。そのため実際の商品とはデザイン、外観などで多少異なることがあります。また、このカタログに記載されている仕様、価格、デザイン等は2020年1月1日現在のものです。予告なしに変更する場合がございます。予めご了承ください。

ご注意 Lightech製品は一部の製品を除き、レース専用部品です。公道での使用はお控え下さい。製品に関する情報このカタログの掲載されている製品は、全てイタリア国内で生産しております。また、カタログに存在する写真や情報の著作権・所有権は、Lightech srl. または、株式会社NichiiX (iMotorcycle Japan)に帰属します。無断での使用、転載はご遠慮ください。

オートバイのモデル・年式について このカタログに掲載されているオートバイのモデル・年式につきましては、ヨーロッパ仕様のモデル・年式です。日本仕様のモデル・年式とは異なる場合がございます。購入される場合は、必ず事前に取り付けに関する適合の可否をご自身でご確認していただけますよう、お願いいたします。適合違いによる返品はお受け出来かねますので、ご注意ください。



