

AIR *Water* LIFE

Advanced Air & Water Technologies for Better Living

AQUA-IONIZER DELUXE 7.5

WATER IONIZER
AirWaterLife.com



Read Carefully
Before Initial Use



Retain Manual for
Future Reference

OWNER'S MANUAL

Table of Contents:

- *Included with Your Water Ionizer/Parts & Supplies* 01
- *Water Ionizer Assembly Overview* 02
- *Safety Instructions & Symbols* 03
- *Technical Specifications* 11
- *Installation Schematic & Instructions* 13
 - 1. *Identify Required Connector/Attach Faucet Diverter Valve* 14
 - 2. *Install the Inner Carbon Filter* 16
 - 3. *Inlet & Outlet Hoses* 17
 - 4. *Attach Metal Spout* 18
 - 5. *Connect the Inlet Water Hose to the Faucet Diverter Valve* 18
 - 6. *Check for Leaks* 20
 - A. *R/O Systems and Well Water* 21
 - 7. *Plug In the Water Ionizer* 22
 - 8. *SET LIGHT* 22
- *FREE pH Kit* 23
- *ORP Testers* 23
- *Understanding the LCD Display* 24
- *Understanding Your pH Presets* 25
- *Selecting Your pH Preset & Dispensing Water:* 26
- *Automatic Cleaning Function* 26
- *Enhanced Cleaning Function* 27
- *Manual Cleaning & Descaling* 28
- *Problems & Solutions* 30
- *Warranty Information* 32

Included with Your Water Ionizer/Parts & Supplies:

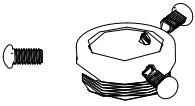

**3-Bolt Faucet
Connector**
(1)



**Inner Tread
Faucet Joint**
(1)

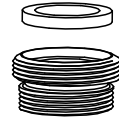

**Dual-Tread
Faucet Connector**
(1)

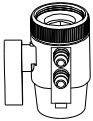

**Faucet Diverter
Valve**
(1)

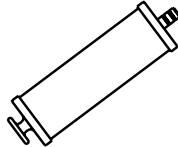

**Carbon
Water Filter (1)**
Standard
Water (City)

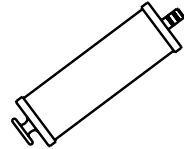

**Mineral/Carbon
Water Filter(1)**
RO or Low pH
Water



**Pre-Installed
Inlet and Outlet Hose**



**Flexible
Metal Spout**
(1)

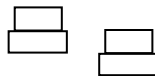

Silicone Caps



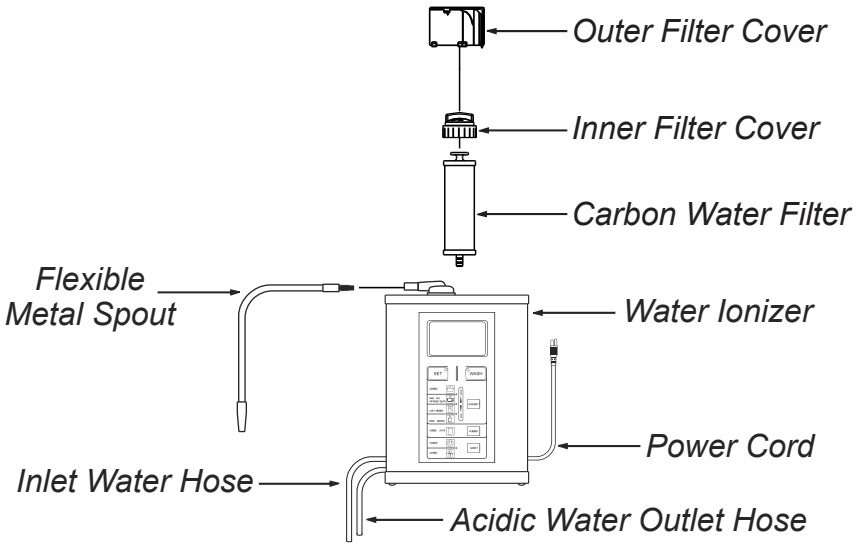

Important Note: As a result of minor technical or aesthetic changes some ionizer parts may appear slightly different in appearance or color than depicted on product packaging or in this manual. Should this occur, the part(s) remain usable and should be installed and used in accordance with this product manual.

Water Ionizer Assembly Overview:



Alkaline Water Presets:

COOKING  = 9.5 - 11.0 pH

MAKE TEA & COFFEE  = 9.5 - 10.0 pH

DAILY DRINKING  = 8.5 - 9.5 pH

INITIAL DRINKING  = 7.5 - 8.5 pH

Filtered Water Preset:

PURIFIED WATER  = Same pH as Source Water
(Most Municipal Tap Water is 7.0 pH)

Acidic Water Presets:

CLEANING  = 6.0 - 7.0 pH

CLEANING  = 5.5 - 6.5 pH

Safety Instructions & Symbols:



Avoid the specified action as it may destroy the unit, cause serious injury or even death.



Avoid the specified action as it may damage the unit or cause serious injury.



Do NOT perform the specified action.



The specified action is very important and must be completed for the unit to function properly.



Most City Water in the USA Works Great

Source Water Requirements - Please pay attention to the source water requirements outlined below prior to installing and operating your water ionizer...

- The source water entering water ionizer must meet applicable local standards that make it suitable for drinking. Despite the unit's built-in water filter, it should NOT be attached to a water source not intended for drinking. The purpose of the carbon filter is to remove residual chlorine, other chemicals, and odors from water already suitable for human consumption in order to improve its taste. The filter is NOT intended as the sole purification source for water that does not meet these standards. Attempting to use the water ionizer in this manner will void the warranty, reduce the unit's performance, shorten its operational life and could jeopardize the health and life of anyone drinking water that could potentially still be harmful.
- The water flow entering the water ionizer from the source water connection must be 0.8 liters per minute or faster for the water ionizer to operate properly. If the water flow is too slow, the water ionizer may not be able to induce water flow and therefore cannot start normally. If your municipal or other water source flows slower than 0.8 Liters per minute, you may need to install a booster pump.
- The pressure of source water that goes into the unit must be under 43.5 pounds per square inch (psi) / 0.3 megapascals (Mpa) for your water ionizer to operate properly and to avoid damaging the unit. If your water pressure is higher than this, you should install a water pressure reducer to lower the source water pressure before it's fed into your water ionizer.

 CAUTION

**If you have an R/O (Reverse Osmosis) System
or low pH WELL WATER**

PLEASE USE the included Mineral/Carbon filter. This mineral filter will add back the beneficial minerals the ionizer needs to function properly.

1-888-601-5886

 IMPORTANT

 DO NOT

Do Not install your water ionizer in any of the following locations...

- *Near an open flame, in direct sunlight or anywhere temperatures could exceed 140° F (60° C);*
- *Near flammable liquids;*
- *Outdoors or any place where the unit could be directly exposed to rain, snow, high winds or other weather elements;*
- *Saunas or other facilities with unusually high levels of humidity levels; or*
- *Any spot where water or other liquids might drip on the unit's exterior.*

 WARNING

 IMPORTANT

To avoid electrical shock and fire hazards:

- *Be sure the electrical plug is seated fully in the power outlet.*
- *Do NOT bend, pinch, clamp, place heavy objects upon, modify, or otherwise damage the unit's power cord or plug.*
- *Do NOT plug the unit in if the cord, plug or the outlet is damaged.*
- *Do NOT drag the unit by its power cord or plug.*
- *Contact a qualified electrician immediately if the cord or plug becomes damaged.*

 CAUTION

***If You have an R/O System
(REVERSE OSMOSIS)
or
low pH WELL WATER***

PLEASE USE the included Mineral/Carbon filter.

This mineral filter will add back the beneficial minerals the ionizer needs to function properly.

Any Questions Just call

1-888-601-5886

**WARNING****IMPORTANT**

- Do NOT share the electrical outlet used for your ionizer with other electrical appliances. See Page 9 for more information.
- Use only alternating current 110V power supply. Exceeding the rated power range may damage the unit and/or cause a fire.
- Do NOT attempt to plug in, unplug, or otherwise operate your water ionizer if your hands are wet.
- Do NOT submerge the unit in water nor use alcohol, flammable, toxic or corrosive chemicals when cleaning this unit. You should clean the exterior of your water ionizer by using a slightly damp cotton cloth with a small amount of dish washing liquid.
- If the unit falls into or is doused by water or any other liquid, immediately pull its powerplug from the electrical outlet.
- This appliance is not intended for use by persons (including children) with reduced physical, sensory or mental capabilities nor by individuals with otherwise limited knowledge, skills and abilities regarding the operation of electrical appliances in general and water ionizers in specific unless they have received supervised and/or written instruction (such as this manual) in their safe operation.
- Young children should be supervised when attempting to operate the unit.

**CAUTION****DO NOT**

- Do NOT place your water ionizer less than 3 feet from your oven, furnace, space heater or any other active heat source or device.
- Do NOT disassemble, attempt to repair or modify your water ionizer. This should only be done by a professional service technician.

**CAUTION**

- If you have existing water hoses from a previously owned water ionizer or other water dispensing, filtration or purification devices, these hoses should be discarded and the new hoses provided with your new water ionizer should be used instead.



WARNING



IMPORTANT

Health Issues: If any of the following apply to you, please consult your physician before drinking or continuing to drink ionized alkaline water:

- *You have kidney disease, renal failure, and/or have difficulty discharging/eliminating potassium in which case you should generally NOT ingest alkaline water.*
- *You are receiving medical treatment for another disease or illness;*
- *You are chronically ill or otherwise in very poor health;*
- *Your health appears to deteriorate after you've begun drinking alkaline water;*
- *Previously existing health issues do not improve despite continuously consuming alkaline water.*



CAUTION



IMPORTANT

Beginning to Drink Alkaline Water: Your body may take a while to get use to alkaline water:

- *When drinking alkaline water for the first time, dispense the water using your unit's "Initial Drinking" setting and consume only small amounts, 8 to 16 ounces (0.25 to 0.5 liters) per day.*
- *Continue this practice for at least 2 weeks prior to advancing to your unit's higher pH value "Daily Drinking" setting at which time you should try to consume 32 to 64 ounces (1 to 2 liters) of alkaline water per day.*
- *Attempting to drink higher pH value water before your body becomes used to alkaline water can result in temporary digestive, dermatological or other health related problems.*



CAUTION



DO NOT

Alkaline Water & Medications: Do NOT drink alkaline water prior to, with or immediately following taking pills or other medications. Instead, use your unit's "Purifier Water," i.e., filtered but not ionized, water setting. As a general rule, you should not consume alkaline water within 45 mins. to one (1) hour either before or after taking medication.

! IMPORTANT

Storing Ionized Water: Under normal temperature conditions, alkaline water stored properly in a sealed, insulated container will retain its ionized properties for at least 24 hours and up to 48 hours when refrigerated.

- *Do NOT store ionized water in metal containers. It should only be stored in plastic, glass or ceramic containers.*
- *Exposing the container to direct sunlight may shorten the period that alkaline water is able to retain its ionized properties.*

⚠ CAUTION

Cosmetic Water Use: When using mildly acidic water from your water ionizer's "Cosmetic" setting for skin care, as an astringent or for hair care, please discontinue use and consult your physician if you develop a skin rash or other allergic reaction.

⚠ CAUTION

! IMPORTANT

Pets & Ionized Water: Dogs, cats and other mammals may benefit from drinking ionized water. However, there are a few simple rules:

- *Especially if your animals have any preexisting health problems, consult your local veterinarian before giving them alkaline water and/or following any negative health reaction to the alkaline water.*
- *Start them off slowly on "Initial Drinking" setting and keep them there for at least 2 weeks prior to moving to the "Daily Drinking" setting. As a general rule, it's probably best not to exceed 9 pH.*
- *Do NOT give your pet alkaline water within 45 mins. to an hour before or after meals. Use the "Purified Water" setting instead. The higher pH levels can neutralize their stomach acids making it more difficult for them to absorb nutrients.*
- *As with humans, Do NOT give your pets ionized water within 45 mins to an hour prior to, with or after taking medication. Doing so can alter the intended absorption rate of the drug.*
- *While the "Cosmetic" water setting can be used to treat your pets' minor wounds and improve its skins and coats, you should check carefully for any allergic reactions or skin irritation.*

 CAUTION

Fish & Aquariums: Unless you are an experienced aquarium owner or qualified aquatic life professional, Do NOT introduce ionized water to your aquarium without knowing the precise alkaline or acidic water settings applicable to your particular fish species. Fish may become ill or die if their water's pH balance is changed or changed too quickly.

Exotic Pets: Lizard, snake, turtle, frog and other reptile and amphibian species vary dramatically in the pH levels to which they are suited. Please contact your veterinarian or pet shop owner prior to giving them ionized water.

Plants: Different plants thrive on water of varying pH levels. For example, some plants prefer more alkaline environments while others perform better in more acidic ones. Consequently, before watering your plants with ionized water, you should determine specifically the type of pH balance most conducive to the growth of your specific plants.

 IMPORTANT

Flushing Residual Water: Because a certain amount of water remains trapped in your water ionizer's filters and tubing, you should briefly drain this water off prior to each use.

- *In order to remove any residual water left in your water ionizer, you should generally dispense water from the unit for approximately 1 second before each new period of use.*
- *If you have not used the unit for at least 2 weeks, you should dispense water from the unit for at least 3 mins before using it.*

 WARNING

 IMPORTANT

Tainted & Leaking Water: If any of the following occurs, stop drinking water from your ionizer immediately and contact an authorized service technician. Not doing so could damage your health...

- *Taste or pH testing reveals that water dispensed from the unit which should be alkaline is coming out acidic;*
- *Residual water appears to be dripping from the unit and/or is discovered to be collecting around the electrodes during routine cleaning and maintenance.*



CAUTION



DO NOT

Continuous Operation: Do NOT exceed the following maximum continuous operational time frames for your water ionizer:

- *Do NOT operate the unit in "Initial Drinking," "Daily Drinking" or "Cosmetic" mode for more than 60 minutes continuously.*
- *Do NOT operate the unit in "Cleaning," "Cooking" or "Make Teas/Neutralize Liquor" mode for more than 30 minutes continuously.*



WARNING



IMPORTANT

Consumable Water Limits: Though extremely high or low pH water can be used for purposes besides drinking, e.g., cooking food, cosmetic purposes or household cleaning, etc., humans, unless directed by their physician for some unusual medical reason, should not generally drink water higher than 10 pH nor lower than 7 pH on a regular basis.



WARNING



IMPORTANT

Grounding: Your water ionizer should only be connected to an electrical circuit that is protected by a "ground-fault circuit interrupter," (GFCI)...

- *This appliance must be grounded. In the event of a malfunction or breakdown, grounding will reduce the risk of electric shock by providing a path of least resistance for electric current.*
- *This appliance is equipped with a cord having an appliance-grounding conductor and a grounding plug.*
- *The plug must be plugged into an appropriate outlet that is installed and grounded in accordance with all local codes and ordinances.*
- *Improper connection of the appliance-grounding conductor can result in a risk of electric shock.*
- *Check with a qualified electrician or service representative if you are in doubt as to whether the appliance is properly grounded.*
- *Do not modify the plug provided with the appliance; if it will not fit the outlet, have a proper outlet installed by a qualified electrician.*

! IMPORTANT

Waste Disposal: In compliance with the "Waste Electrical and Electronic Equipment Directive"...

- *This marking indicates that this product should not be disposed with other household waste throughout the EU (European Union).*
- *To prevent possible harm to the environment or human health from uncontrolled waste disposal and to conserve material resources, this product should be recycled responsibly.*

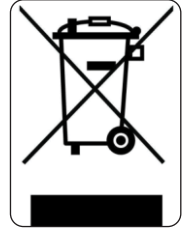

- *To dispose of your product, please use your local return and collection systems or contact the retailer where the product was purchased. They can take this product for safe environmental recycling.*

Technical Specifications:

Model.....	AWL-7500
Installation	Countertop/Optional Undersink Kit Available
Number of Plates.....	7
Plate Construction.....	Platinum Coated Titanium
Plate Surface Area	122 square inches
Plate Technology	Long-Life/Low Power Consumption RTI Distinct
Constant Electrolysis	Yes; 60 minutes
Power System.....	Transformer
Voltage.....	AC 110V/60Hz
Wattage.....	4W idle/200W
Rated Power.....	200W*

**Rated Power Consumption indicates the maximum power usage when the unit's "Cooking" setting is engaged, ionized water pH output is constant and rated inflow, water temperature and total dissolved solids (TDS) are at their default value. The actual power consumption varies to maintain a constant pH depending on the inflow rate, water temperature and TDS*

Technical Specifications: (continued)

Max. Operating Temp	60°C / 140°F
Source Water Temp.....	5° - 60°C / 41° - 140° F
Operational Pressure	14.5 - 43.5 psia / 0.1 - 0.3 Mpa
Water Flow Rate	4 liters per min (adjustable)
pH Levels	7 total: 4 alkaline, 1 neutral, 2 acidic
Adjustable pH	Yes: 3.5 to 11.0, depending on intake source
ORP Range	-850mV to +1000mV
Measurements.....	8.25 (W) x 13 (H) x 4.3(D) inches
Weight	8.0 pounds
Filter System.....	Active Carbon Filter
Filter Change Alert	Yes; LCD display
Filter Life	4000-6000 Liters / 1585 Gallons Approx. 6 months to 1 Yr. with normal usage
Cleaning Cycles.....	1. After each use, unit automatically cleans itself for 10 seconds by reversing positive and negative plate polarity. 2. Every 40 liters (10.6 gal.), the unit cleans itself for 30 seconds by reversing positive and negative plate polarity. 3. After each year of use, the unit should be cleaned manually following the cleaning and descaling instructions in this manual.
LCD Size.....	6.3 sq in: 3.5 in x 1.8 in: 7 colors, 1 per setting
Control Panel.....	Ultra-Responsive Bio-Touch Pad
FDA Approved Plastics.....	Yes
ETL Certified	Yes
Warranty.....	Limited Life-time Warranty

Installation Schematic: (Optional Wall Mount)

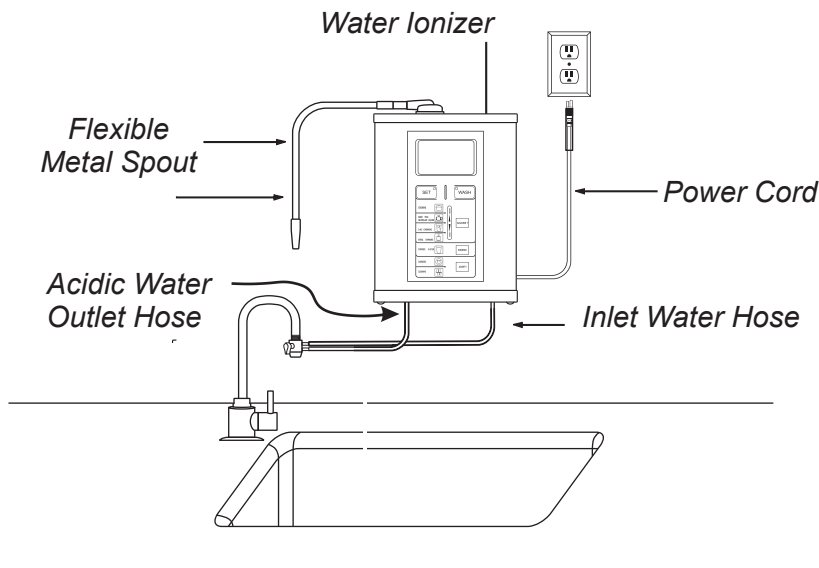

www.AirWaterLife.com/install

Video Install Guide ONLINE

Installation Order: There are 7 simple steps to installing your water ionizer each of which is described in detail beginning on the next page. Please follow each of the following steps in order.

1. Identify Required Connector(s) & Attach Faucet Diverter Valve
2. Insert the Water Ionizer's Inner Carbon Filter
3. Pre-Installed Inlet & Outlet Water Hoses
4. Install the Metal Spout
5. Connect the Inlet Water Hose to the Faucet Diverter Valve
6. Check Connections
7. Plug In the Water Ionizer

Installation Step 1 - Identify Required Connectors/ Attach Faucet Diverter Valve: Home faucets typically fall into 1 of 3 categories, a.) threaded on the outside, b.) threaded on the inside, and c.) unthreaded, i.e., those without screw on/in connectors.



a. Threaded on Outside

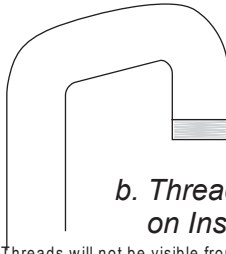

b. Threaded on Inside

Threads will not be visible from outside.
Feel inside faucet spout for threads.

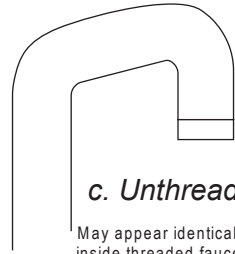

c. Unthreaded

May appear identical to an inside threaded faucet from the outside.

The type of faucet you have will determine whether you can attached the Faucet Diverter Valve directly to your faucet or which of the type of faucet connector(s) you will use to attach the Faucet Diverter Valve to your faucet. There are three connectors included with your water ionizer, a 3-Bolt Faucet Connector, an Inner Thread Faucet Joint and a Dual-Thread Faucet Connector.



3-Bolt Faucet Connector



Inner Thread Faucet Joint



Dual-Thread Faucet Connector

a) Thread Outside Faucet: You will usually not need to use a connector. Simply screw the Faucet Diverter Valve directly onto the faucet.

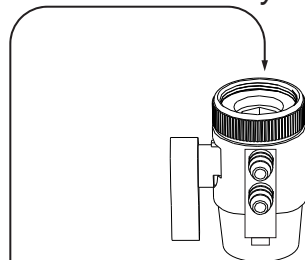
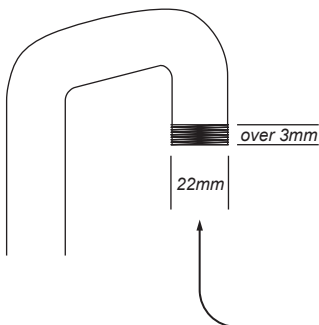

Faucet Diverter Valve

b) *Threaded Inside Faucet: Being sure to first insert the washer, screw the Dual-Thread Faucet Connector into the faucet. Then screw the Faucet Diverter Valve onto the Dual Tread Connector.*

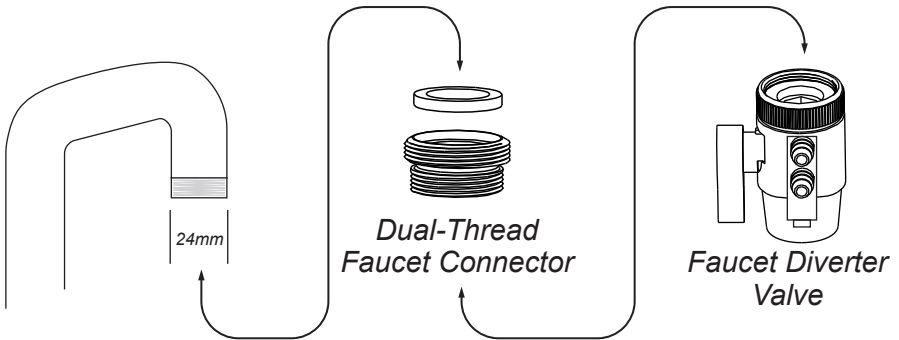

c) *Unthreaded Faucet: If your faucet has neither inside nor outside threads, loosen the bolts on the 3-Bolt Faucet Connector, slip it over the end of the faucet pressing upward firmly then tighten bolts securely locking it on to faucet. Next, screw the Inner Faucet Thread Joint securely into the bottom of the 3-Bolt Faucet Connector. Then screw the Faucet Diverter Valve onto Inner Thread Joint which you've just attached to the 3-Bolt Faucet Connector.*

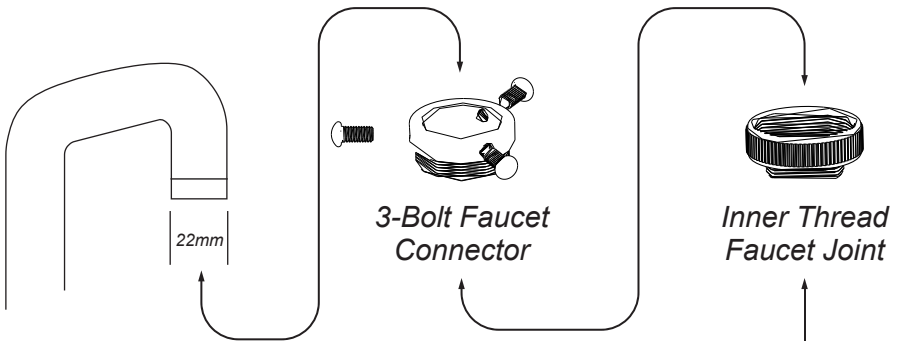

! IMPORTANT

In some instance, either because the threads are damaged, too wide, or too narrow, you may need to use the 3-Bolt Faucet Connector assembly method even on Threaded Inside or Outside Faucets.

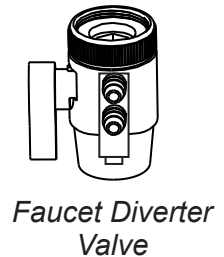

Installation Step 2 - Insert the Inner Carbon Filter:

Though your water ionizer's Inner Carbon Filter is shipped with your water ionizer, it is NOT preinstalled in the unit. Simply remove the filter from the box, remove any packing materials, and install it in the following manner:

A. Remove the water ionizer's Outer Filter Cover by pressing on the arrow with your thumb, squeezing gently with your finger and pulling up.

B. Firmly grasp the water ionizer's Inner Filter Cover and twist it counter clockwise to open and gain access to the filter chamber.

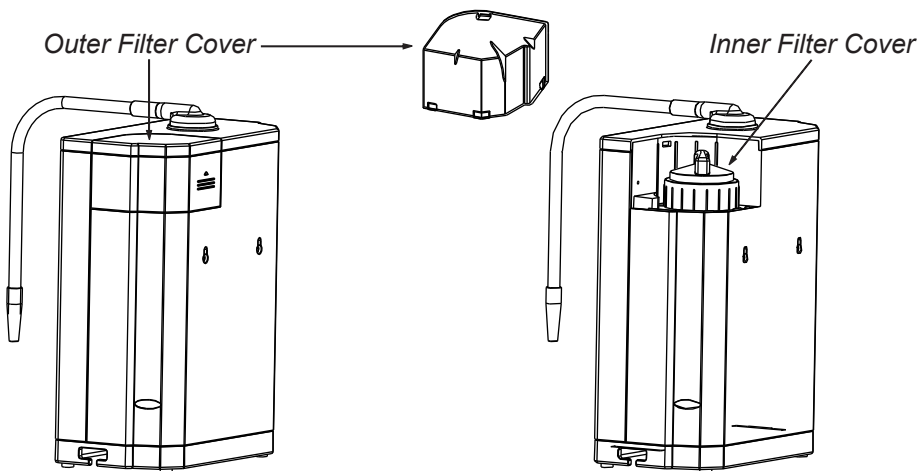

Fig. A

Fig. B

C. After unpacking the new Inner Carbon Filter, hold the end with the sealing ring on it under running tap water for 3 minutes to flush away any loose carbon particles, remove excess air, and to prime the filter.

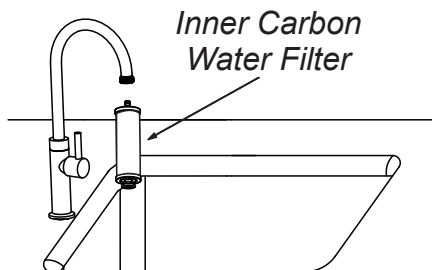
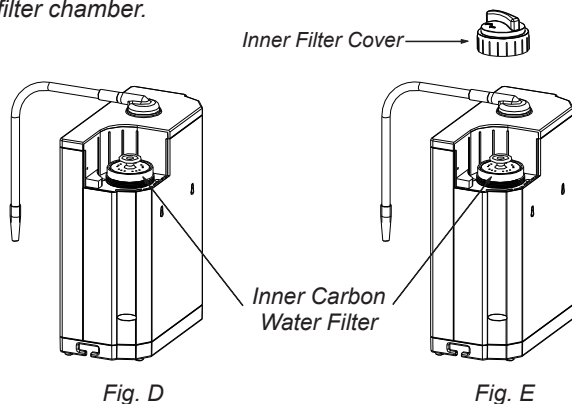

Fig. C

D. Insert the newly flushed Inner Carbon Filter into the open filter chamber as shown in Fig. D.

E. Reseat the Inner Filter Cover and twist it clockwise to close the filter in filter chamber.



Replacing Filters: The Inner Carbon Filter should be replaced after every 4000-6000 liters / 1585 gallons of water being dispensed, which means it will last up to a year under normal use conditions. However, regional, environmental, and other differences in water quality, such as more polluted municipal water, may require the filter to be replaced more often. If you notice an unusual odors or taste in your water replace the filter as necessary.

! IMPORTANT

VIDEO FOR HELP - www.AirWaterLife.com/install

Installation Step 3

- A) Your lonizer will come with two 1/4 inch white hose installed. With caps on the end.

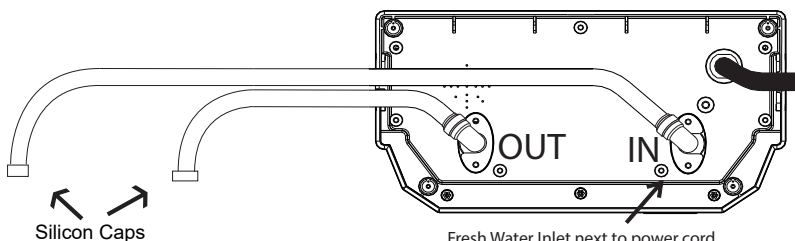

- B) The Out Hose will have a RED dot that will match up with the RED dot on the Diverter in the next step.

Note: You may need to cut the hoses shorter again to fit your setup if you have extra, but please wait until you are done with the installation. Once Cut, each section is about 3 feet long.

Installation Step 4 - Attach Metal Spout:

REMOVE THE PLASTIC Inner Cover

Screw the flexible Metal Spout clockwise into the outlet connector on top of the water ionizer.

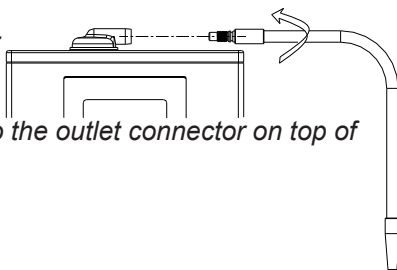

Installation Step 5 -

Connect the Inlet Water Hose to the Faucet Diverter Valve:

Connect the Inlet Water Hose to the top faucet diverter valve and the Acidic Water Outlet Hose into the bottom valve.

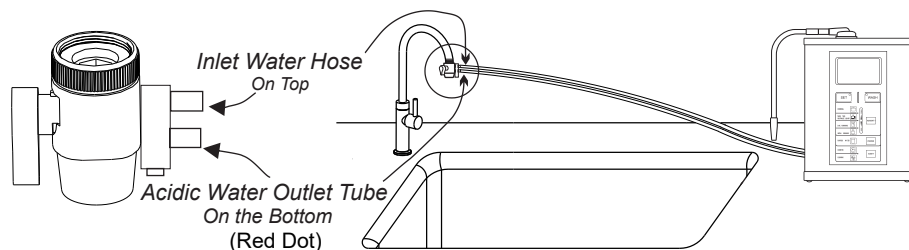

The Out Hose will have a RED dot that will match up with the RED dot on the Diverter.

CAUTION: Be sure that the Metal Spout, and the white $\frac{1}{4}$ " hoses for the source water ('IN') and the acidic ('OUT') are attached correctly to the bottom of the unit as described in Steps 3 & 4. Remember the Water Inlet is near the Power Cord.

Installation Step 5a (special) Connect the Inlet and Acid Water Hoses to the Faucet Diverter Valve:

There are two (2) post hose connectors for the hoses on the Faucet Diverter Valve. The 'top' barbed post connector is for outgoing water which when diverted with the control handle will flow into the water "in" port on the bottom right side of the unit (control panel facing you). This is called your 'supply line'.

The 'bottom' connector is for the 'acidic' 'out-line' from the left bottom of the unit (control panel facing you) this 'out-line' allows the acidic water to flow out of the small spigot next to the larger spigot (normal water flow is from the larger spigot). This diverter when attached to the faucet end provides alkaline water when the diverter is activated or normal tap water if the diverter is set for tap water.

In order to attach either hose to the top or bottom connector the hose must be 'slid' onto the Diverter about 1/2 inch. You can also use a few drops of water inside the hose to help "slide" the hose onto the connector.

For More Help Call 888-601-5886

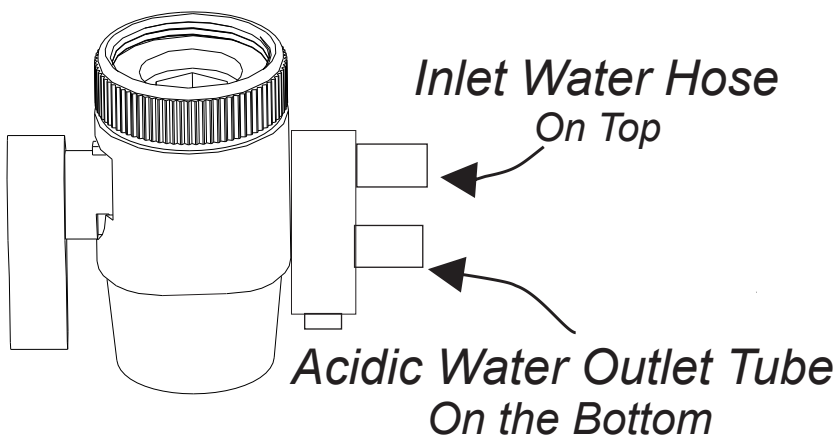

Installation Step 6 - Check for Leaks: After completing all prior installation steps and making sure all hoses are securely attached, you should perform each of the following filter related tasks when a) initially installing the unit, b) each time you replace the unit's Inner Carbon Filter and c) any time the unit has not been used for 2 or more days...

A. If you have not already done so, insert the filter as described under Step 2 - Insert the Inner Carbon Filter. Be certain you have placed the filter under running tap water for at least 3 minutes to flush away any loose carbon particles, remove excess air and to otherwise prime the water filter. Also be sure the Inner Filter Cover is screwed firmly over the Inner Filter Cartridge.

B. With the Faucet Diverter Valve still switched on and source water still flowing into the unit, confirm that there are no leaks from any of the hose connection points, the Inner Filter Cover nor from anywhere else on the water ionizer. This process will also flush any remaining air from the water filter.

C. If there are no apparent leaks, replace the Outer Filter Cover and temporarily plug the unit into the proper electrical outlet as described in Step 8 – Plug In the Water Ionizer.

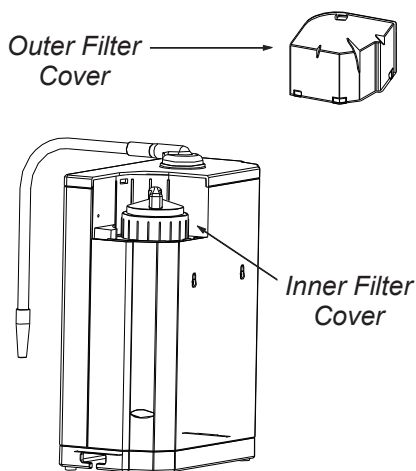

! IMPORTANT

D. Press and hold the "Set" button continuously on the unit's front for at least 10 seconds to fully flush the filtration system and to clear any message prompts about replacing the filter.

E. After fully installing and priming the Carbon Water Filter, if this is the first time you've installed your water ionizer, unplug the unit and proceed to Step 7 - (Optional) Wall Mounting Your Water Ionizer. If instead you are simply replacing an existing filter, your finished simply return to using your water ionizer normally.

Reverse Osmosis (R/O) or Well Water

If your water source is from a tested safe to drink well/ground water or has passed through a “Reverse Osmosis” system you may not have enough beneficial minerals in your water for the Water Ionizer to function at it’s full potential.

However we have a solution for you.
Please use the included Mineral/Carbon Filter
Any Questions Call

1-888-601-5886

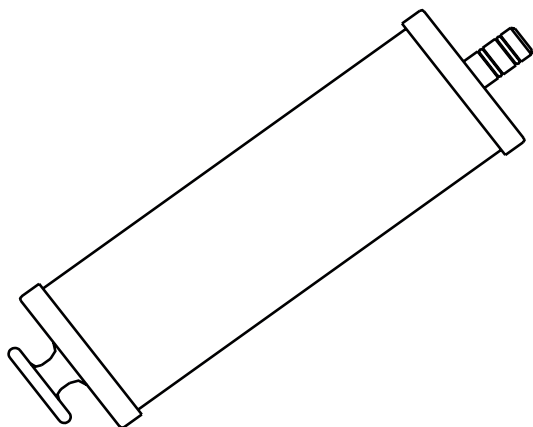

Carbon & Mineral Filter

This filter will add back the beneficial minerals that your “R/O” or well water is missing.

Installation Step 8 - Plug In Your Water Ionizer:

A.) Confirm that the power outlet is a 110 V/60Hz and grounded **BEFORE** plugging in your water ionizer.

B. When you first plug the unit in, a water indicator, e.g., "Daily Drinking," will light. The LCD will not display, however, until water is flowing into the unit. So, if you have not already done so, be sure you've switched on the Faucet Diverter Valve and water is flowing into the unit.

C. When it initially starts up your water ionizer will briefly enter auto cleaning mode. Do **NOT** unplug the water ionizer when it's in auto cleaning mode. Doing so can damage the unit.

-When the Set light comes on it is time to change the filter.

SET

-After you change the filter just hold down the SET button for 10 Seconds until the Set light turns off.

NOTE: The Liter counter will not reset.

pH Presets:

1. **Factory pH Value Presets** - Your water ionizer's primary pH settings are preset at the factory within the following ranges.

Alkaline Water Presets:

COOKING  = 9.5 - 11.0 pH

MAKE TEA & COFFEE  = 9.5 - 10.0 pH

DAILY DRINKING  = 8.5 - 9.5 pH

INITIAL DRINKING  = 7.5 - 8.5 pH

Filtered Water Preset:

PURIFIED WATER  = Same pH as Source Water
(Most Municipal Tap Water is 7.0 pH)

Acidic Water Presets:

CLEANING  = 6.0 - 7.0 pH

CLEANING  = 5.5 - 6.5 pH

2. **Impact of Environmental & Other Factors on pH** - However, differential regional, environmental and testing factors such as the quality, pH level, Total Dissolved Solids (TDS) and temperature of the source water as well as the flow rate through the water ionizer can all cause variations in the pH level of the water dispensed from your water ionizer. For example, the above referenced pH preset values were derived from 68°-77° F (20°-25° C) source water with a neutral pH of approx 7.0 containing 100 - 150 parts per million of Total Dissolved Solids (TDS) flowing at 2L (0.5 gal) per minute.

⚠ CAUTION

- *Do NOT Use Litmus Paper to Evaluate pH - Most commercially available litmus paper is much less accurate tool for measuring pH than the pH Reagent (testing liquid).*



**Would You Like a Free pH Test Kit?
Just call 1-888-601-5886 or visit
www.AirWaterLife.com**

ORP TESTERS

Caution using store bought ORP Testers. Many of these testers are designed for Fish Tanks and Swimming Pools only. These NON-Professional ORP testers are not designed to be accurate after -100 ORP.

As a general rule if your Ionizer is producing Alkaline Water it is also producing negative ORP.

Every Ionizer is tested with a Laboratory Certified ORP Tester before it leaves our factory to insure proper functionality.

Understanding Your LCD Display: In addition to the alerts and indicators described below, your LCD displays in 1 of 7 different colors, to indicate which of the unit's 7 presets is currently selected.

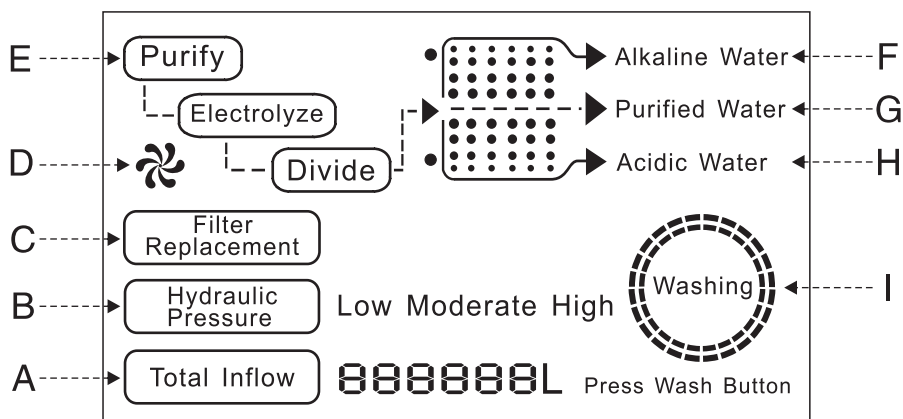

- A. Total Inflow Monitor** - Displays the total commutative water flow through the water ionizer.
- B. WATER Pressure** - You always want **LOW OR Moderate, NEVER HIGH.** (You can adjust the water flow speed at the supply tap knob)
- C. Filter Replacement Alert** - Advises the user when it's time to replace the Inner Carbon Filter.
- D. Water Flow Indicator** - Rotates to confirm that inlet source water is flowing into the water ionizer.
- E. Purify, Electrolyze & Divide Monitor** - This active display confirms your water ionizer is progressing through various water filtration, electrolysis, and water separation stages.
- F. Alkaline Water Indicator** - Confirms the water ionizer is dispensing alkaline water.
- G. Purified Water Indication** - Confirms the water ionizer is dispensing purified, i.e., filtered but non-ionized water.
- H. Acidic Water Indicator** - Confirms your water ionizer is dispensing acid water.
- I. Washing Flasher** - Lets the user know the water ionizer is in automatic cleaning mode. *Note: Never, simply unplug your water ionizer when it's in Washing Mode. Doing so may damage the unit.*

Understanding Your pH Preset Options: Your water ionizer has 7 pH presets: 4 Alkaline, 1 Purified and 2 Acidic. Each is shown below along with its control panel icon, factory set pH range and the general application(s) for which each setting should be used.

Alkaline Water Presets:



COOKING

9.5 - 11 pH

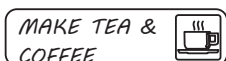

*MAKE TEA &
COFFEE*

9.5 - 10.0 pH



DAILY DRINKING

8.5 - 9.5 pH



INITIAL DRINKING

7.5 - 8.5 pH

Purified Water Preset:

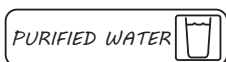

PURIFIED WATER

*Averages 7.0 pH**

Acidic Water Presets:



COSMETIC

6.0 - 7.0 pH

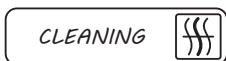

CLEANING

5.5 - 6.5 pH

General Application:

This setting is ideal for cooking since alkaline water dramatically improves the flavor of vegetables, rice, pastas, and soups. Water from this setting is also perfect for washing fruits and vegetables, removing not only dirt and bacteria, but also chemical pesticides and fertilizers far more effectively than regular tap water. It even makes a great stain remover for removing coffee, oil, grass, and other stubborn stains.

Alkaline water at this setting enhances the flavor, color and aroma of both tea and coffee.

Drinking 2 or more daily glasses of alkaline water acts as a powerful antioxidant and can help offset the effects of eating highly acidic foods such as meats, egg yolks, fried foods, processed foods, coffee, and it aids hydration.

If you are new to drinking ionized alkaline water, you should start by consuming small regular amounts, ionized alkaline water at this level daily for a week or two of prior to progressing to the somewhat higher alkaline Daily Drinking water setting since it may take your body a short while to adjust to the higher alkaline drinking water setting.

This setting filters, but doesn't ionize water. It should be used when taking pills or other medications. Consuming ionized water within an hour of taking medications can affect a drug's absorption rate resulting in harmful or unintended consequences. This option is also ideal for use in baby food preparation since ionized water may be harmful or difficult for children under the age of a year old to digest.

Acid water from this setting makes a great skin exfoliant removing dead cells and acts as an astringent which tightens the skin, removes fine lines and wrinkles. And, because acidic water kills surface bacteria on the skin, it also helps fight acne and blemishes without harmful chemical residues. Shampooing and rinsing your hair with water from this setting enhances shine and manageability and reduces breakage.

Highly acidic water from this setting makes an extremely effective cleaning, disinfecting, and antibacterial agent. It is particularly suited for cleaning kitchen and bathroom surfaces such as counter tops, cutting boards, sinks, toilets, tubs, showers, mirrors, and linoleum and tile floors. Best of all, while acidic water outperforms many commercial cleaners, it does so without all the harmful chemicals and toxins.

**Purified water is filtered but not ionized. So, it derives its pH from source tap water which averages 7.0 pH.*

Selecting Your pH Preset & Dispensing Water:

A. Once properly installed and plugged in with water flowing to the unit, your water ionizer will enter standby mode displaying the most recently selected preset, e.g., Daily Drinking.

B. To change to a different preset, a) press the Alkalinity button to cycle through each of the 4 alkaline water settings. Each press advances you to the next alkaline preset... Cooking – Make Tea & Neutralize Liquor – Daily Drinking – Initial Drinking; b) press the Purified button to select filtered but nonionized water; and c) press the Acidity button to cycle back and forth between the 2 acidic water presets... Cosmetic – Cleaning.

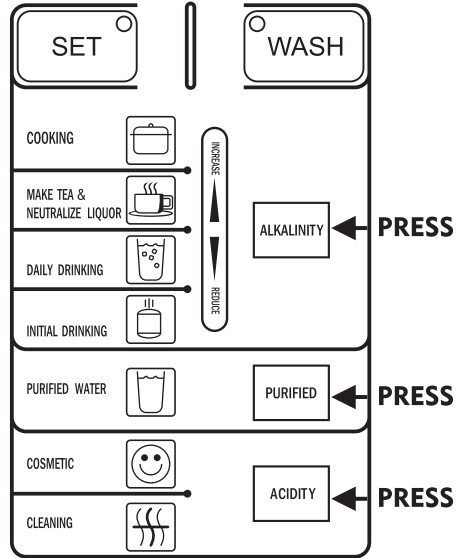

C. After making your water selection, turn on your water faucet, flip the attached Faucet Diverter Valve to the on position diverting water to the water ionizer which will then begin dispensing water matching the pH preset selection.

D. Once you're done dispensing water simply shut off your faucet and/or the attached Faucet Diverter Valve.

Automatic Cleaning Function

A. Whenever the water ionizer is in any of the 4 alkaline modes or either of the 2 acidic modes, ending water flow to the unit by turning off the faucet or Faucet Diverter Valve will cause your water ionizer to reverse electroplate polarity, thus initiating the automatic cleaning process.

B. Auto-cleaning is NOT triggered if the last function prior to shutting off water flow to the unit was Purified water mode. The unit's electroplates are not engaged as part of the Purified Water process, consequently, there is no need for auto-cleaning the electroplates after using this function.

C. When automatic cleaning is triggered, it will take only about 20 seconds during which time the Washing Flasher will appear on the unit's LCD display. When auto-cleaning is completed, the Washing Flasher will disappear and the LCD will display only the Total Inflow data as the unit returns to standby mode.



D. NEVER unplug the unit or attempt to carry out other water ionizer functions while the unit is in automatic cleaning mode. Doing so can damage your water ionizer.

Enhanced Cleaning Function

A. In addition to the auto-cleaning function that's initiated just before the unit enters standby mode after dispensing alkaline or acid water, your water ionizer also has an extended Enhanced Cleaning function designed to help reduce the buildup of calcium, magnesium, and other chemical and mineral deposits on the unit's electroplate. The Enhanced Cleaning function is triggered after approximately every 10.5 gallons/40 liters of water have been dispensed.

B. When Enhanced Cleaning is required, a flashing Wash Indicator light will appear on the unit's LCD. Note: The Wash Indicator, which has a solid circle around it, is NOT the same as the Washing Flasher which has dual broken line circles around it.



C. When the Wash Indicator appears, turn on the faucet and Faucet Valve. As water begins to flow to the water ionizer, press the Wash Button on the Control Panel to initiate Enhanced Cleaning.



D. During enhanced cleaning, which will last for approximately 30 seconds, the unit will play music and water will be expelled from the Flexible Metal Spout. Do NOT drink this water as it will be acidic.

E. When the music finishes, Enhanced Cleaning is complete and the unit will reset to whatever the last selected preset was.

F. NEVER unplug the unit or attempt to carry out other water ionizer functions while the unit is in Enhanced Cleaning mode. Doing so can damage your water ionizer.

Manual Cleaning & Descaling:

Descaling removes these mineral deposits ("scales"), which inhibit the electrolysis process, from the surface of the electroplates. If your local source water is particularly high in mineral deposits and/or if routine pH testing reveals an increasingly wide variance from the preset values over time, you should descale your water ionizer.

For More Information On Descaling Call 1-888-601-5886

We have Multiple Descaling Options Available

- A. Switch off the Faucet Diverter Valve so water is NOT flowing into the water ionizer. Wait at least 20 seconds for the unit to return to standby mode after completing any Automatic Cleaning processes and then unplug water ionizer from the electrical outlet, remove it from it's wall mount and place upright on the sink counter.

! IMPORTANT

- B. Unscrew the Inner Filter Cover. Then, Remove the Carbon Water Filter from the Filter Chamber and set it and the Inner Filter Cover aside.
- C. Remove both the Inlet Water and Acidic Water Outlet Hoses from the Diverter Valve. Now insert both caps onto the hoses. See Below. If you've misplaced your "Caps", you can use a paper clip, small clamp, wrapped rubber band, etc, to temporarily block just the Acidic Water Outlet hose.

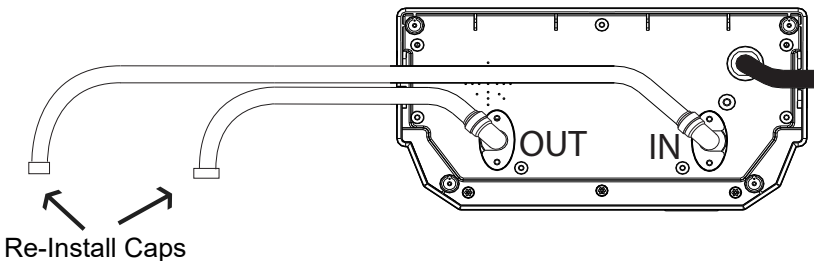

D. Raise the Flexible Metal Spout as shown in Fig. 2 below, to ensure the spout opening is HIGHER than the top the water ionizer itself.

E. Fill a pitcher, jar or other waterproof container with approximately 2 cups (17oz / 500ml) of HOT (NOT boiling) water and pour the entire contents of the bottle of powdered descaling agent into the hot water. Stir the mixture until the Descaling Agent is fully dissolved.

F. Slowly pour the Descaling Agent liquid into the empty Filter Chamber until its about 3/4 inch (2 cm) from the top of the chamber and allow the Descaling Agent to soak inside the unit for at least 30-60 minutes.

G. After soaking for at least 30 minutes, disconnect one "Silicone Stopper" from the Water Inlet Valve allowing the Descaling Agent liquid to drain from the water ionizer. Once fully drained, remove the other "Stopper" from the Acidic Water Outlet valve. Reattach Water Inlet and Acidic Water Outlet Hoses and save the "Stoppers" for future use. Alternative Method: Remove the clip or rubber band from the Acidic Water Outlet Hose allowing the Descaling Agent liquid to drain from the water ionizer.

H. With the Inner Carbon Filter STILL REMOVED, bend the Flexible Metal Spout into it's normal position, i.e., so that the spout opening is LOWER than the top the water ionizer itself.

I. Next, turn on the water faucet and open the Faucet Diverter Valve so that water begins flowing into the unit. Allow water to continue flushing though the unit for at least 5 minutes to help wash away any residual descaling agent.

J. Finally, close the Faucet Diverter Valve, reinsert the Inner Carbon Filter, replace the Inner and Outer Filter covers completing the descaling process. Continue to use your water ionizer normally.

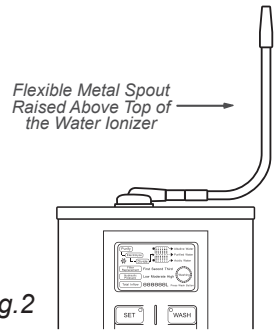
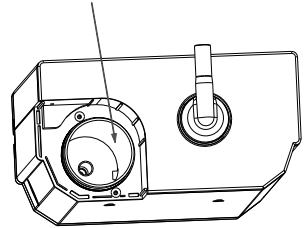

Fig. 2

Fig. 3

Pour Descaling Agent liquid to within 3/4 inch (2 cm) of the top of the empty Filter Chamber. (Filter must be REMOVED!)



Problems & Solutions:

Problem: None of the LCD or Control Panel functions light up.

Solution: Check that the power cord is plugged in and/or that the electrical socket is functioning properly. Make sure water is flowing through the machine. Call for more help 1-888-601-5886

Problem: Water from the water ionizer dispenses too slowly or irregularly in spurts or sputters.

Solution: a) Check hoses, valves, and connections to make sure they're not obstructed; b) check to see if the water filter needs to be replaced, and/or c) if you live in a cold climate, make sure neither your source water or water in the ionizer has frozen.

Problem: Alkaline water output appears initially cloudy or milky.

Solution: This is generally a temporary anomaly caused by harmless, nontoxic hydrogen production as part of the electrolysis process. The cloudiness will disappear on its own after a few seconds and will not affect the taste of your drinking water. It can also happen because of extremely high levels of calcium and magnesium in your source water (known as "hard water") when ionizing higher pH levels. This phenomenon is also harmless and will not affect the taste of drinking water. However, you can reduce the instances in which the cloudiness occurs by a) lowering the pH level or b) increasing the water flow rate through the unit

Problem: White particles begin to appear in your alkaline water and/or on the walls of the filter chamber.

Solution: Hard water high in calcium and magnesium can cause this type of particle buildup. Though the particles are harmless and do not affect taste, you can reduce or eliminate them by descaling your water ionizer more frequently.

Problem: The rate water is dispensed through the Flexible Metal Spout begins to diminish over time.

Solution: This is generally caused by, calcium and magnesium deposits from extremely hard water building up over time along the inside of the spout. Proper or more frequent descaling and/or soaking the spout directly in descaling solution will normally alleviate this problem.

Problem: The rate at which water is dispensed appears to slow down immediately following replacing the Inner Carbon Filter.

Solution: This is generally an indication that there is still some residual air trapped in the water filter. Turning your faucet on high and allowing water to flow through your ionizer at a high rate of speed for 3 or 4 minutes will usually solve the problem.

Problem: Acidic water continues to drip from the Acid Water Outlet Hose for 10 to 20 seconds after dispensing alkaline water.

Solution: This is a normal phenomenon. The excess acidic water is "divided" from the alkaline water as part of the ionization process and then dispelled through the outlet tube.

Problem: Water is very slow producing little to no water.

Solution: The hydraulic/water pressure may be too low. Turn your faucet on high and fully open the Faucet Diverter Valve to increase the pressure. If this doesn't correct the problem, check to make sure that the water filter isn't blocked.

Problem: pH testing reveals that the actual pH of Alkaline water is slighter higher or lower than the factory defined range for a particular preset.

Solution: a) If the pH is somewhat higher than normal, it is generally a normal phenomenon following installing a new Inner Carbon Water Filter. Generally the pH will settle back into the normal range with in a week of installing the new filter; b) If the pH is slightly lower than normal, descaling the unit will usually alleviate this problem; or c) If the pH variance is more extreme, you may want to move up or down to the next preset level to achieve the desired pH level.

Problem: Acidic water seems to have an unusual smell or odor.

Solution: DO NOT DRINK-This acidic water smell is a normal byproduct of electrolysis reacting with the chloride in the water.

Problem: After replacing the Inner Carbon Water Filter the unit continues to prompt the user to replace the filter.

Solution: After replacing the water filter you must press and hold the "Set" button for at least 10 seconds to clear the filter replacement prompt.

Problem: After replacing the Inner Carbon Water Filter fine black particles appear in the water.

Solution: These particles are harmless nontoxic carbon residue from the water filter. This generally occurs when you forget to flush the filter under tap water for a few minutes prior to installation. Simply run water through the water ionizer for a few minutes and the particles will disappear.

Problem: PH range is too low. Such as 7.0 - 8.0 pH on the Cooking setting.

Solution: Your water may not have enough minerals for the ionizer to function properly. Use the Mineral filter. Also see PAGE 22 for more information.

1-888-601-5886

Any Other Questions or Concerns?
We would love to hear from you!

Limited Lifetime Warranty:

Air Water Life and its parent company, Real Spirit USA, Inc., offer a Lifetime Limited Lifetime warranty on all its water ionizers to the original consumer purchaser under the following terms and conditions:

Aqua Ionizer Pro and Deluxe 7.0 models; a) For the first 5 years from the date of original purchase, we warrant the unit to be free from defects in materials and workmanship under normal operation and use and we will repair or replace any defective part(s) or, at our discretion, replace the entire unit free of charge. b) After the first 5 years, we continue to stand behind your purchase for as long as you own it. Should the unit need to be repaired, we will provide the replacement parts at no charge to you. You will be responsible only for the cost of labor to replace the parts. Should the estimated cost to repair the unit exceed 20 percent of the unit's original suggested retail price, we will provide you the customer with an entirely new replacement unit of equal or greater original value for 20 percent of the original suggested retail price.

VIP Limited Lifetime Warranty:

By Purchasing the Aqua Ionizer Deluxe 7.5® your warranty period is extended beyond the 'Limited Lifetime Warranty' to a 'VIP Limited Lifetime Warranty' on parts and labor or a full unit replacement should your Aqua Ionizer Deluxe 7.5 fail at any time now or in the future while in use by the original purchaser.

Whether in the first 5 years or subsequently, upon discovery of a product defect, you should immediately notify Air Water Life via telephone or email the exact problem you are having to the best of your knowledge. If it is determined to need additional diagnostic inspection, then we will provide you a product return authorization and shipping instructions. You should ship or deliver the product to the designated service location, accompanied by your name, address and telephone number, proof of purchase date and a description of the defect. The customer is responsible for the cost of shipping the unit to the service facility. However, following repair or replacement, Air Water Life will cover the cost of shipping the unit back to the consumer within the continental United States. Customers outside the continental United States must also cover the cost of return shipping following repair or replacement.

The warranty does NOT include unusual wear, damage resulting from accident or unreasonable use and also does not include replacement filters nor other disposable parts and supplies. *Unreasonable use also includes using the unit outside of North America and in countries where the voltage may be higher than 110/120 Volts, which is the normal operating range of our products. **Additionally the warranty will become VOID should the case seal be broken and the tamper system activated which shall indicate the unit cabinet was opened for purposes other than authorized by the company. It should be noted that any electronic unit should be serviced only by an authorized service technician duly certified by Real Spirit USA, Inc. All warranties are non-transferable and remain registered to the original purchaser.

Water Damage Liability Statement and Waiver

Air Water Life water ionizers and filters are covered by our limited Lifetime Warranty* Air Water Life or its parent company Real Spirit USA, Inc accepts no liability, nor offers any warranty or remedy for damages of any kind in regard to water damage caused or reported to be caused by leaks from hoses, fittings or directly from any of our products.

Further Air Water Life does not warrant or accept any liability in regard to installing our Ionizer units, hoses, or additional valves or filters. Any such installation is at the sole responsibility of the owner or the third party installer, plumber or contractor.

The customer/ user by purchasing our products accepts full responsibility for insuring that the proper acceptable water pressure is present at the time of installation (as stated in the owners manual). Water pressure is controlled by the supplier or the home owner and cannot be controlled or guaranteed by Real Spirit USA or its affiliates.

All installations should be approved by a nationally recognized P.I.P.E. or other certified contractor.

-P.I.P.E. is the parent company of the National Inspection Testing and Certification Corporation, known in the industry as National Inspection Testing Certification (NITC).-

Once you have installed your unit, it is recommended that connections and connectors are inspected by the owner on a regular basis. It is also recommended that if you are away from the installation for longer than a 24 hour period that you turn off the water supply to your Water Ionizer system as well as turn off the supply power to your unit.

Basic care and maintenance by the owner/ user of this equipment is entirely the responsibility of the purchaser-owner/ user, as Real Spirit USA assumes no responsibility for misuse, faulty installation, or variations in water pressure or quality.

Other than what is expressed in our products warranty, Real Spirit USA assumes no additional liability for these foregoing statements or other 'Acts of God'.

By acceptance of delivery, and the installation the Air Water Life products (filters, ionizers, and accessories) you agree to hold Air Water Life and Real Spirit USA, Inc harmless for any water damage caused by leaking water or for any other reason.



Any Questions?

1-888-601-5886

We would love to hear from you!

Produced and distributed exclusively by:



Air Water Life is a Division of Real Spirit USA, Inc.
320 South Rock Blvd Suite 210 • Reno, NV 89502 • Ph 775.432.2861
www.AirWaterLife.com • info@AirWaterLife.com