



► **Safety and Care Advice**









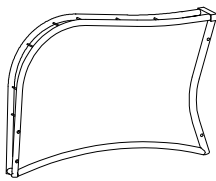
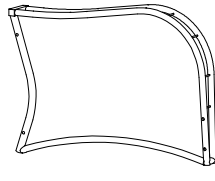
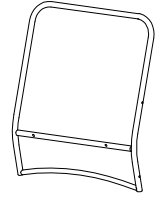
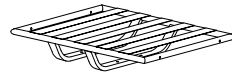
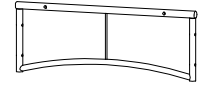
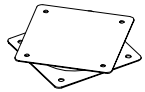
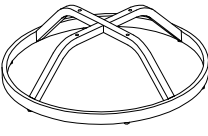
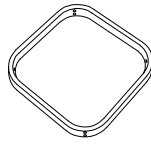

- Please check and make sure you have all the parts indicated before you start with the assembly.
- Assembly work should be performed on a soft surface to prevent the finish to be scratched during assembly.
- Easy wipe clean with a dry or slightly damp cloth. Do NOT use chemical products.
- Please make sure there's no sharp objects (e.g. garden tools, knives and etc.) careful when sitting on the furniture for your own safety. Such items might tear down fabrics or pierce through resin weave, causing permanent damages.
- We recommend furniture to be covered or put away when not in use, in order to prolong product life.

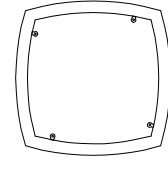
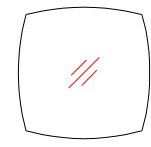
► **Consejos de seguridad y cuidado**

- Antes de comenzar a ensamblar este producto, asegúrese de contar con todas las partes necesarias.
- Es conveniente ensamblar este producto sobre una superficie suave para no raspar el acabado.
- Límpielo con un paño seco o ligeramente húmedo. No utilice productos químicos.
- Debe tenerse cuidado al sentarse sobre el mueble con algún objeto cortante (herramientas de jardinería y cuchillos) en sus bolsillos, ya que pueden desgarrar las telas y penetrar el tejido de resina, lo que lo dañará irreparablemente
- Recomendamos guardar los muebles cuando no estén en uso para prolongar su vida útil

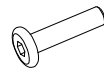
Packing List

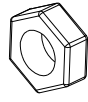
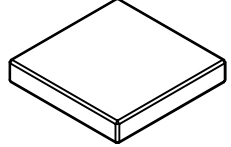
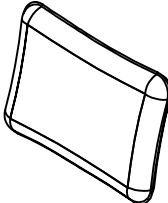
PF22012

					
A 2pcs	B 2pcs	C 2pcs	D 2pcs	E 2pcs	F 2pcs
					
G 2pcs	H 1pc	I 4pcs	J 1pc	K 1pc	Aa 4+1pcs
					
M6*22	M6*30	M6*40	Φ16*Φ8*1.0	M6	
Bb 8+2pcs	Cc 8+2pcs	Dd 32+6pcs	Ee 68+6pcs	Ff 8+2pcs	Gg 2pcs
					
Hh 2pcs	li 1pc	Jj 1pc			

WARNING:

Cushions must be put away in rainy and windy days in case they are diminished or blown away.











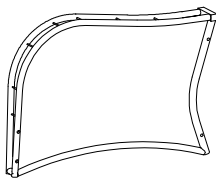
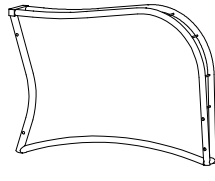
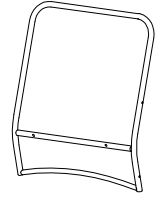

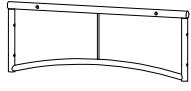
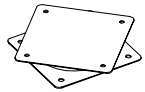
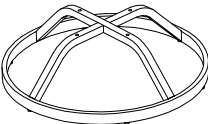
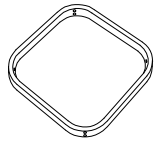
ASSEMBLY TIPS: Please use the hardware and accessories included in the set. DO NOT use other electrical or manual tools. In order to facilitate the assembly and make your final product firm and stable, please tighten by a few rounds each screw one by one. After all screws are connected, then you start to tighten each screw to the end.

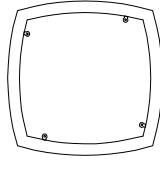
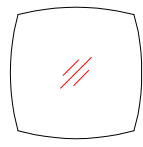
DO NOT tighten any screw to the end before you have connected all screws.

The assembly requires minimal level of DIY skills if you follow the instructions carefully. In case you encounter any difficulty or have any questions, feel free to contact the store or manufacturer.

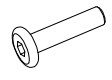
ASSEMBLY INSTRUCTIONS

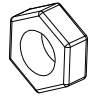
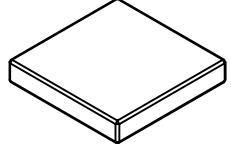
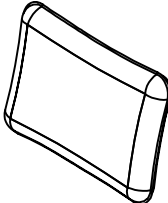
PF22012

					
A 1pc	B 1pc	C 1pc	D 1pc	E 1pc	F 1pc
					
G 1pc	H 1pc	I 4pcs	J 1pc	K 1pc	Aa 4pcs
					
M6*22	M6*30	M6*40	$\Phi 16*\Phi 8*1.0$	M6	
Bb 8pcs	Cc 4pcs	Dd 16pcs	Ee 40pcs	Ff 4pcs	Gg 1pc
					
Hh 1pc	li 1pc	Jj 1pc			

1

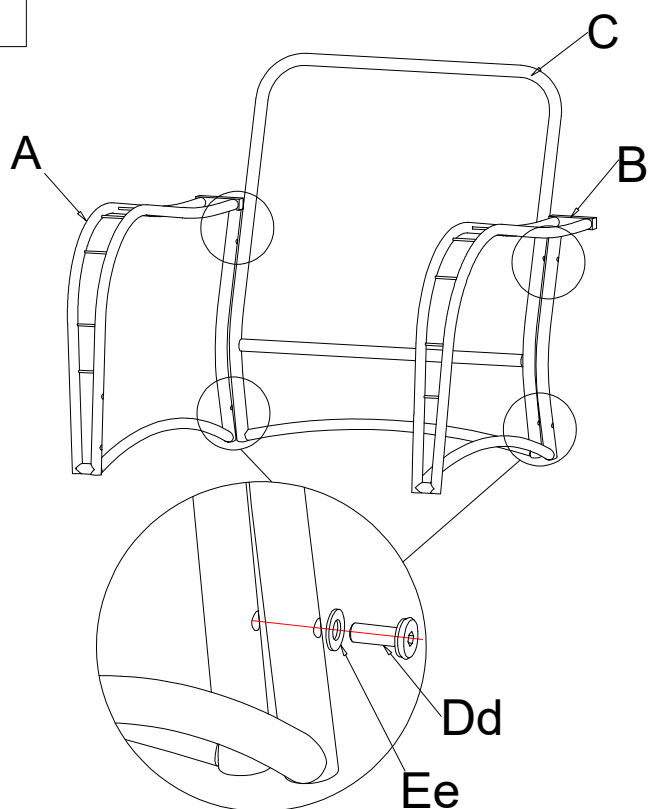

2

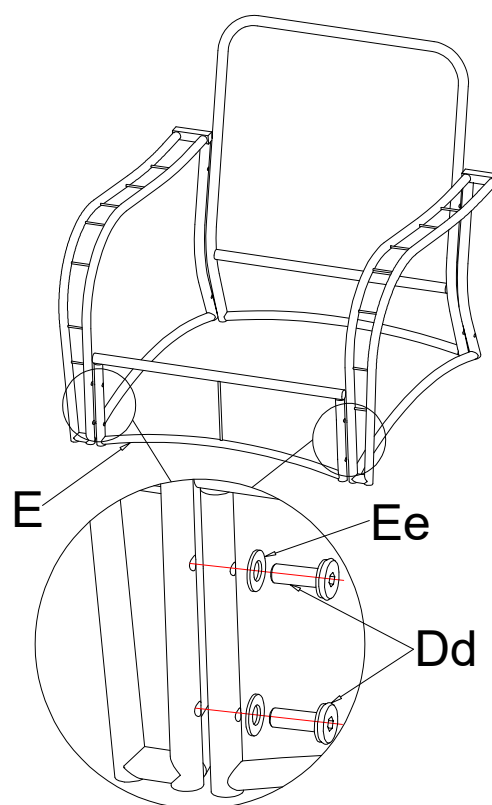

ASSEMBLY INSTRUCTIONS

PF22012

3

!!! Please pay attention to the direction

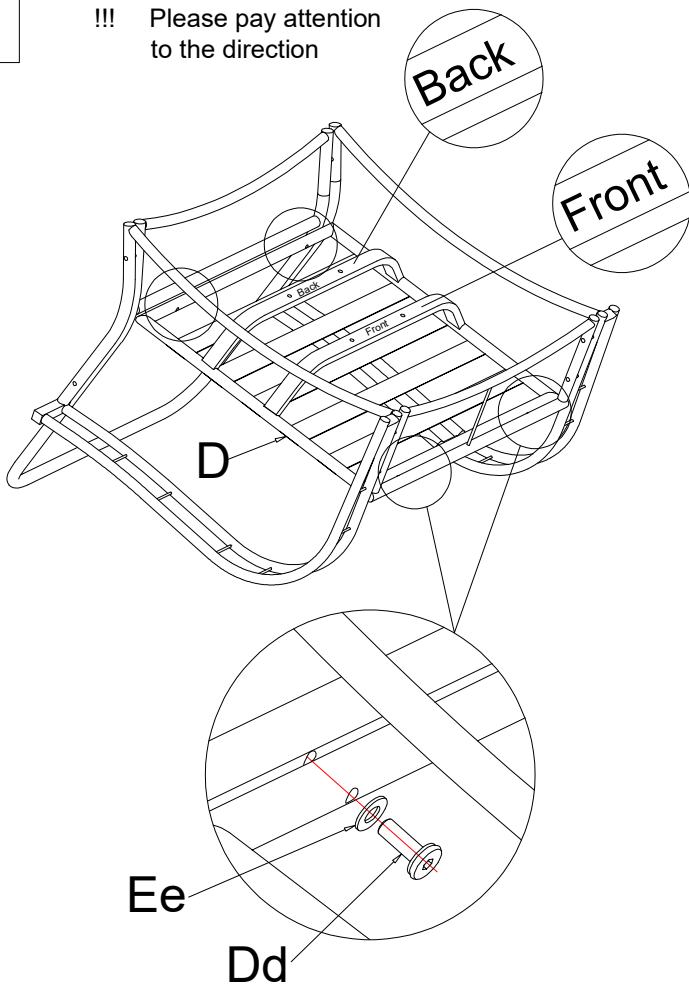

4

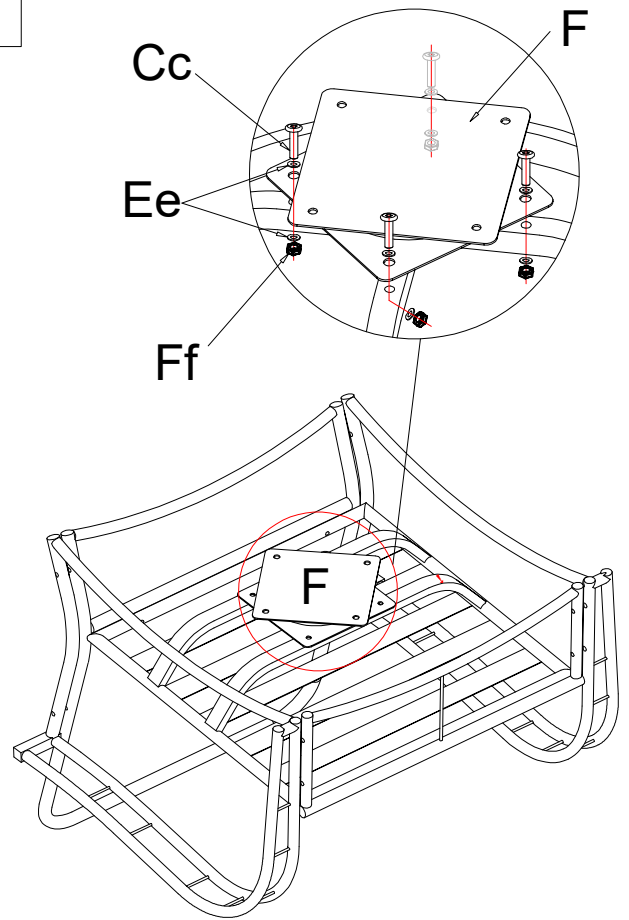

5

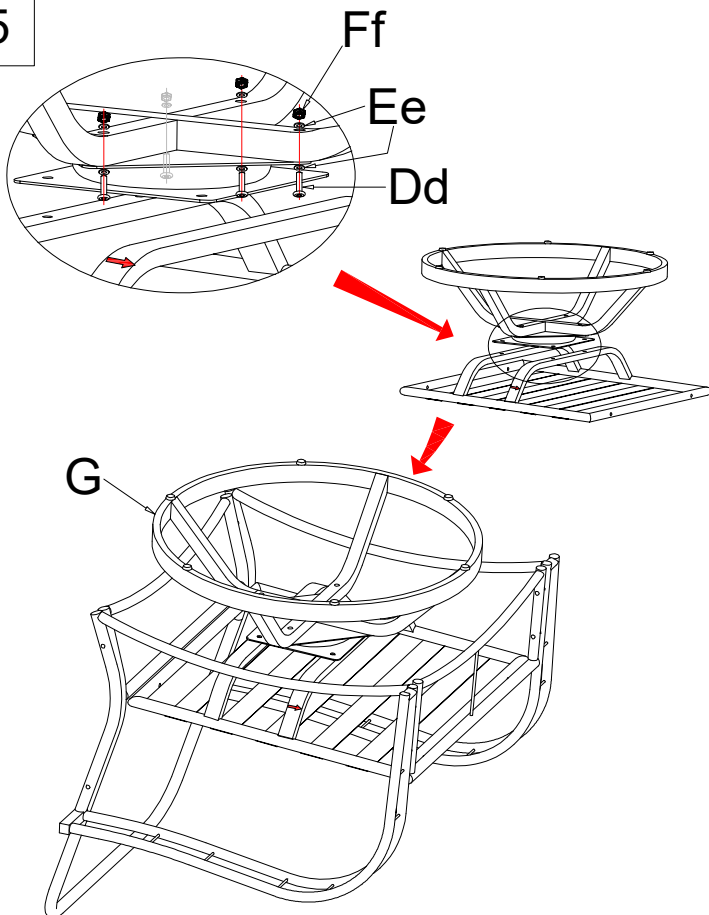

6

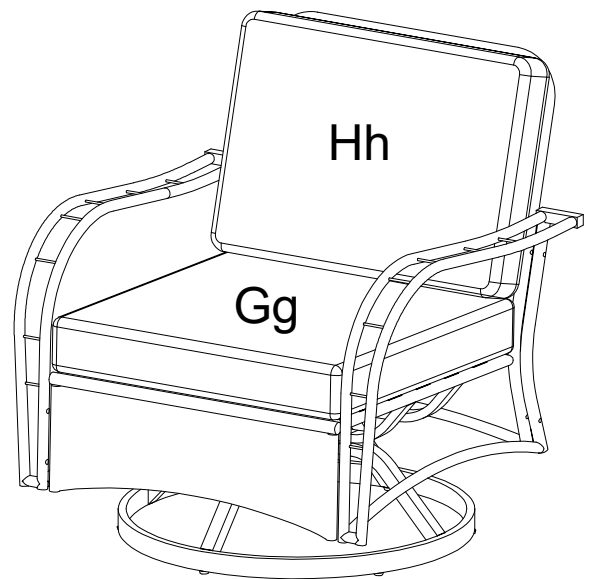

ASSEMBLY INSTRUCTIONS

PF22012

7

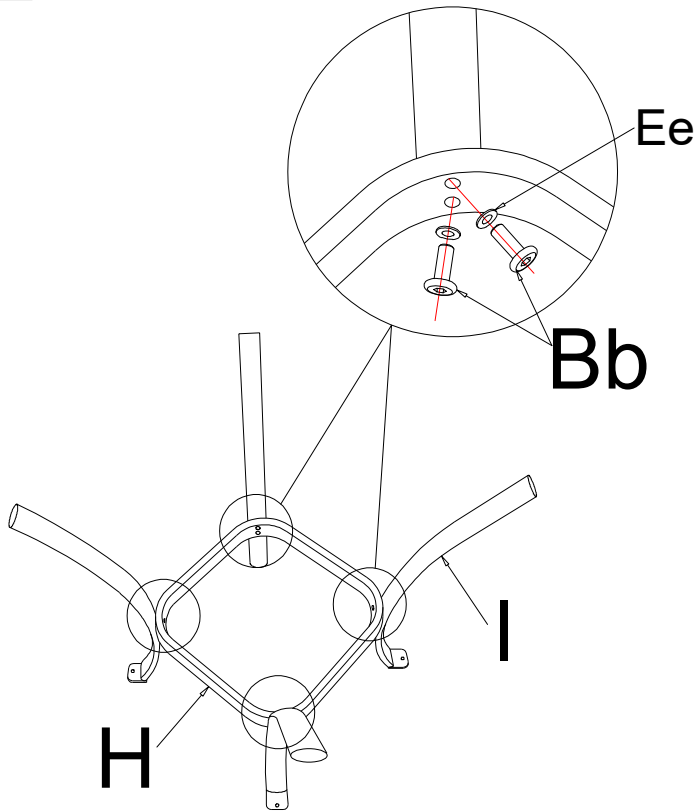

8

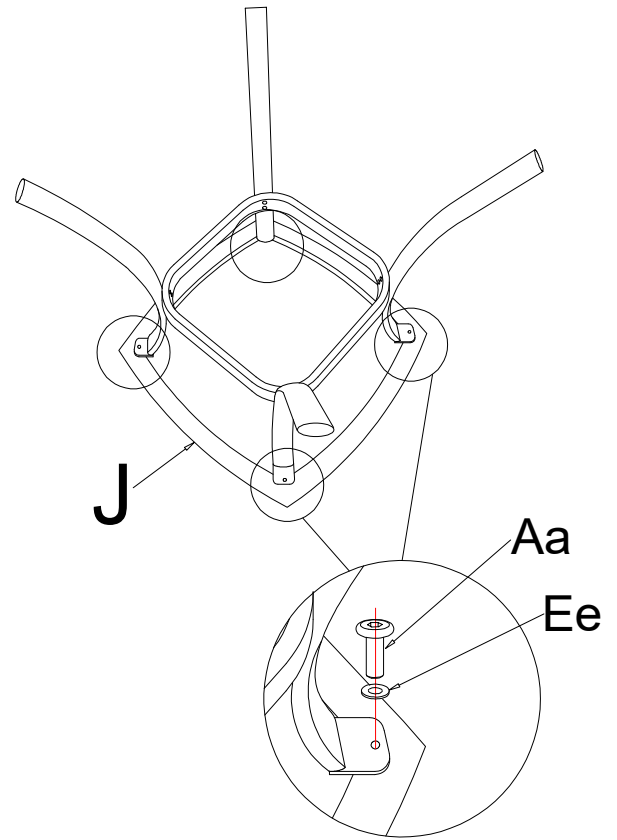

9

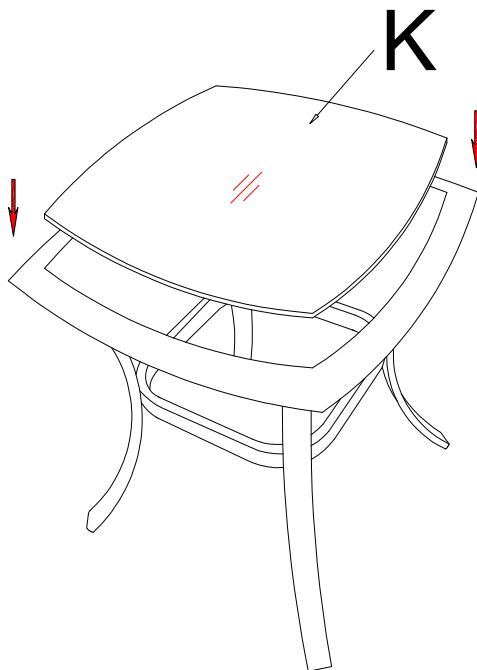

10

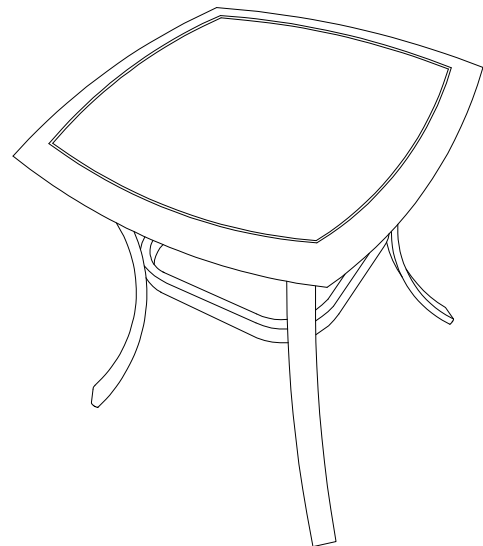

ASSEMBLY TIPS:

Please use the hardware and accessories included in the set. **DO NOT** use other electrical or manual tools. In order to facilitate the assembly and make your final product firm and stable, please tighten by a few rounds each screw one by one. After all screws are connected, then you start to tighten each screw to the end. **DO NOT** tighten any screw to the end before you have connected all screws. The assembly requires minimal level of DIY skills if you follow the instructions carefully. In case you encounter any difficulty or have any questions, feel free to contact the store or manufacturer.



► **Safety and Care Advice**







- Please check and make sure you have all the parts indicated before you start with the assembly.
- Assembly work should be performed on a soft surface to prevent the finish to be scratched during assembly.
- Easy wipe clean with a dry or slightly damp cloth. Do NOT use chemical products.
- Please make sure there's no sharp objects (e.g. garden tools, knives and etc.) careful when sitting on the furniture for your own safety. Such items might tear down fabrics or pierce through resin weave, causing permanent damages.
- We recommend furniture to be covered or put away when not in use, in order to prolong product life.

► **Consejos de seguridad y cuidado**

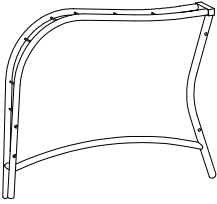
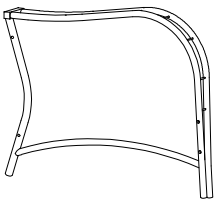
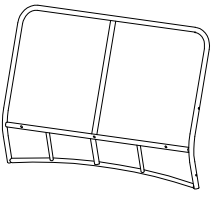
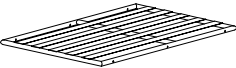
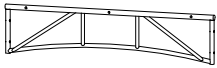
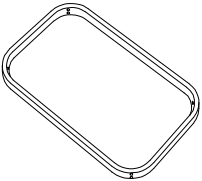
- Antes de comenzar a ensamblar este producto, asegúrese de contar con todas las partes necesarias.
- Es conveniente ensamblar este producto sobre una superficie suave para no raspar el acabado.
- Límpielo con un paño seco o ligeramente húmedo. No utilice productos químicos.
- Debe tenerse cuidado al sentarse sobre el mueble con algún objeto cortante (herramientas de jardinería y cuchillos) en sus bolsillos, ya que pueden desgarrar las telas y penetrar el tejido de resina, lo que lo dañará irreparablemente
- Recomendamos guardar los muebles cuando no estén en uso para prolongar su vida útil

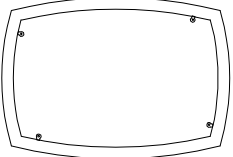
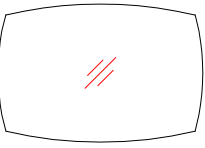
Packing List

PF22014

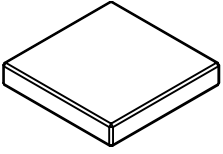
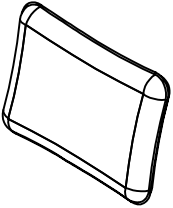
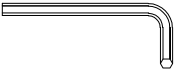
					
L 1pc	M 1pc	O 1pc	P 1pc	Q 1pc	R 1pc
					
S 4pcs	T 1pc	U 1pc	Aa 4+1pcs	Bb 8+2pcs	Dd 14+4pcs
 Φ16*Φ8*1.0					
Ee 26+6pcs	Gg 2pcs	Hh 2pcs	li 1pc		

WARNING:

Cushions must be put away in rainy and windy days in case they are diminished or blown away.







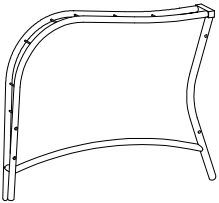
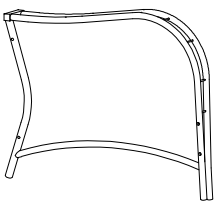
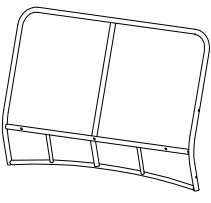
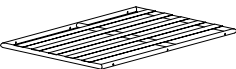
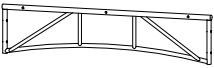
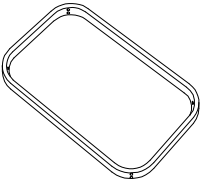

ASSEMBLY TIPS: Please use the hardware and accessories included in the set. DO NOT use other electrical or manual tools. In order to facilitate the assembly and make your final product firm and stable, please tighten by a few rounds each screw one by one. After all screws are connected, then you start to tighten each screw to the end.

DO NOT tighten any screw to the end before you have connected all screws.

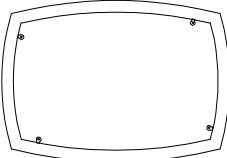
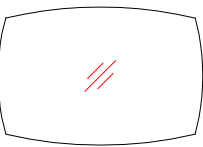
The assembly requires minimal level of DIY skills if you follow the instructions carefully. In case you encounter any difficulty or have any questions, feel free to contact the store or manufacturer.

ASSEMBLY INSTRUCTIONS

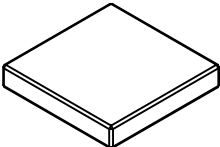
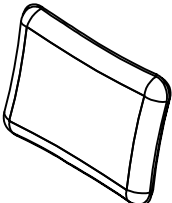
PF22014

					
L 1pc	M 1pc	O 1pc	P 1pc	Q 1pc	R 1pc
					
S 4pcs	T 1pc	U 1pc	Aa 4pcs	Bb 8pcs	Dd 14pcs
					
Φ16*Φ8*1.0 Ee 26pcs	Gg 2pcs	Hh 2pcs	li 1pc		

1

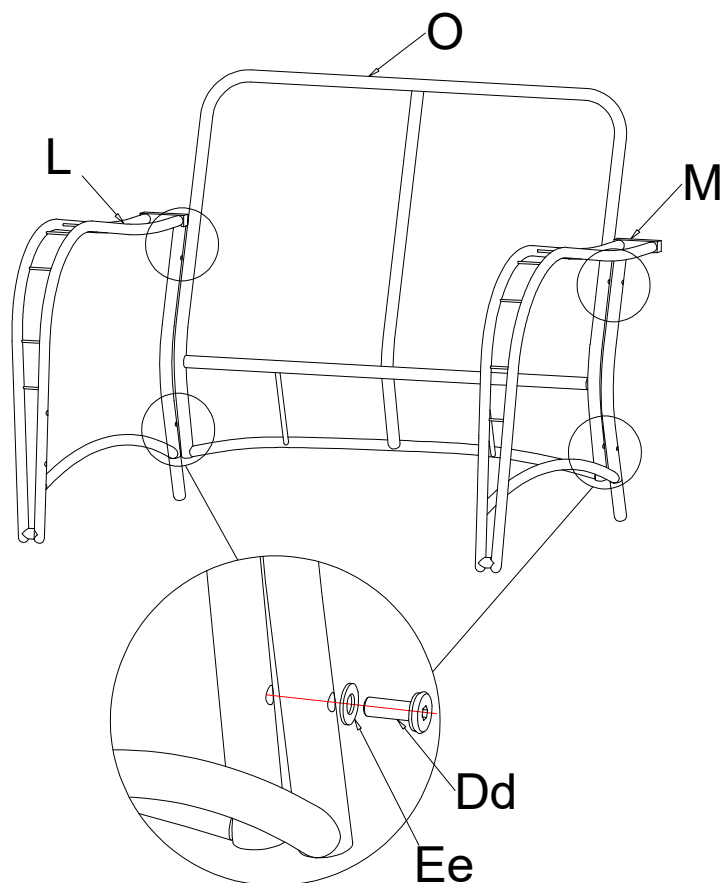

2

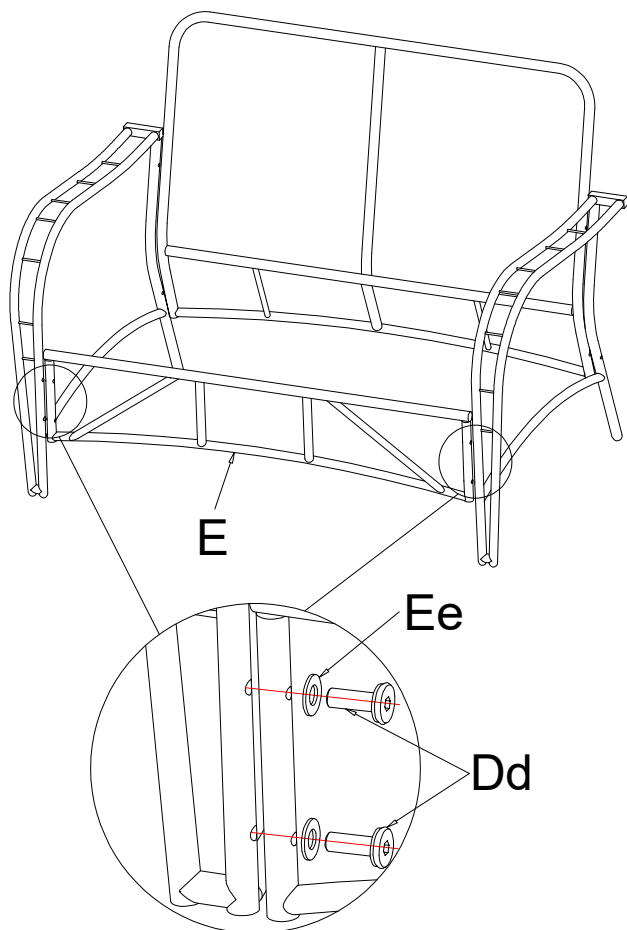

ASSEMBLY INSTRUCTIONS

PF22014

3

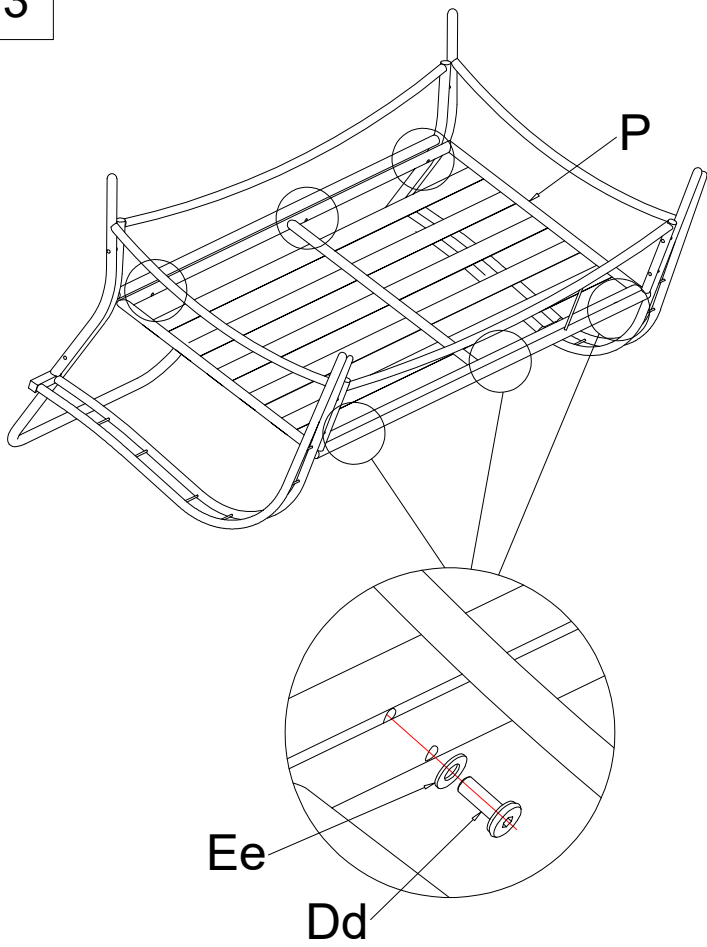

4

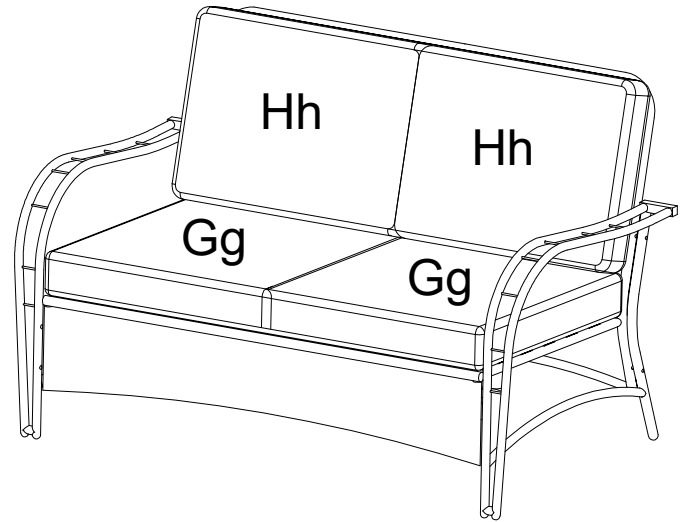

5

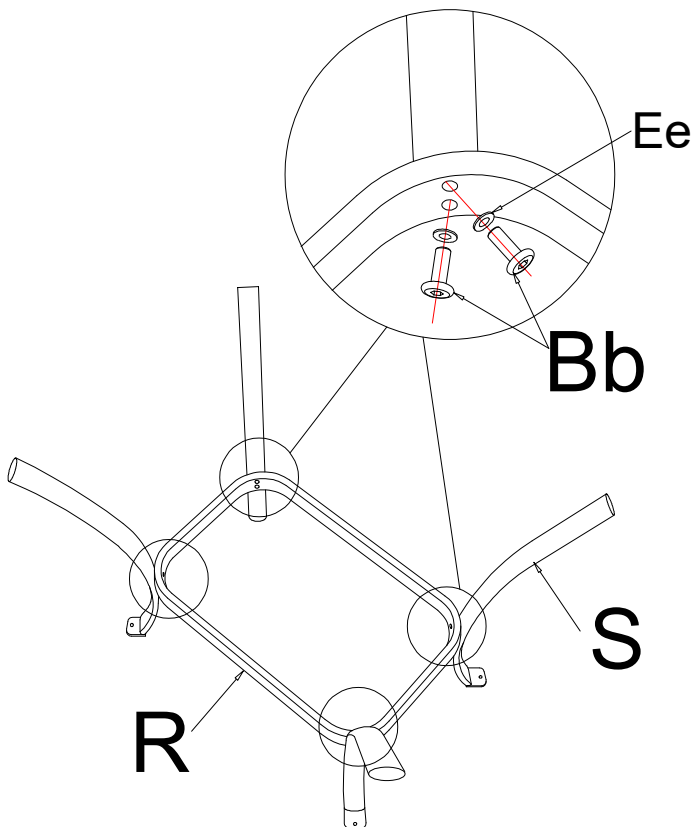

6

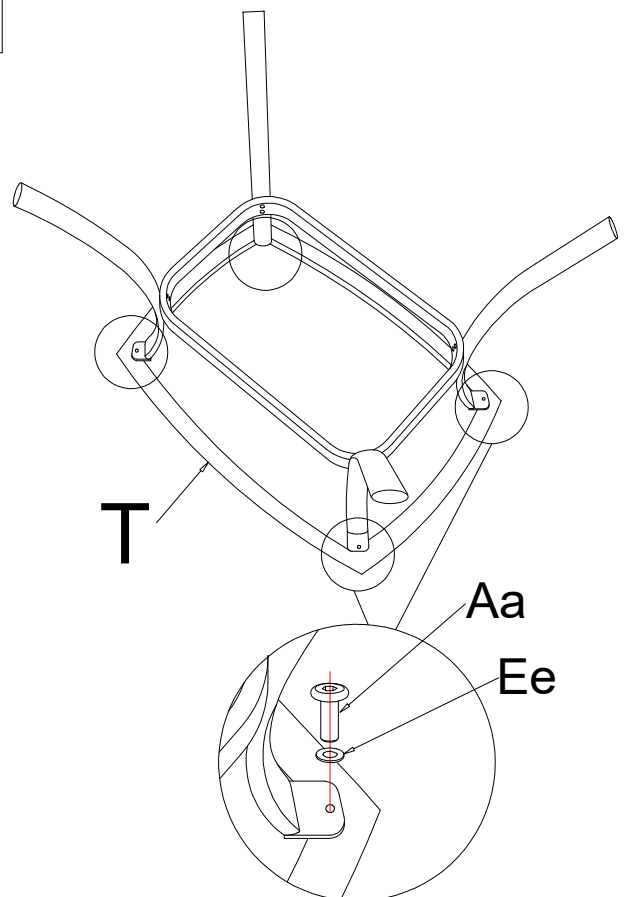

ASSEMBLY INSTRUCTIONS

PF22014

7

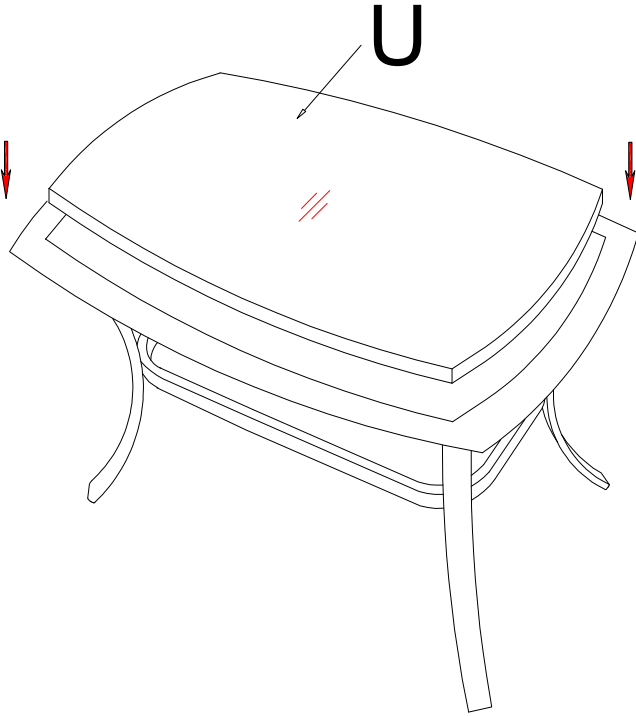

8

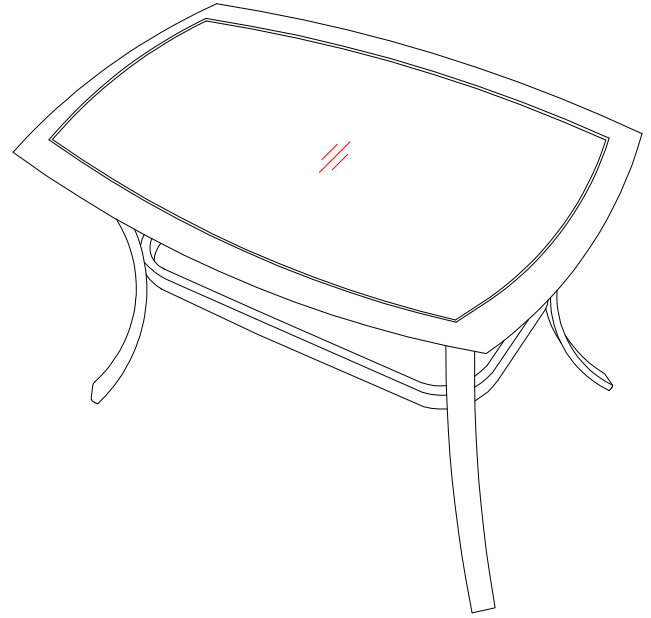

ASSEMBLY TIPS:

Please use the hardware and accessories included in the set. **DO NOT** use other electrical or manual tools. In order to facilitate the assembly and make your final product firm and stable, please tighten by a few rounds each screw one by one. After all screws are connected, then you start to tighten each screw to the end. **DO NOT** tighten any screw to the end before you have connected all screws. The assembly requires minimal level of DIY skills if you follow the instructions carefully. In case you encounter any difficulty or have any questions, feel free to contact the store or manufacturer.