









► **Safety and Care Advice**

- Please check and make sure you have all the parts indicated before you start with the assembly.
- Assembly work should be performed on a soft surface to prevent the finish to be scratched during assembly.
- Easy wipe clean with a dry or slightly damp cloth. Do NOT use chemical products.
- Please make sure there's no sharp objects (e.g. garden tools, knives and etc.) careful when sitting on the furniture for your own safety. Such items might tear down fabrics or pierce through resin weave, causing permanent damages.
- We recommend furniture to be covered or put away when not in use, in order to prolong product life.

► **Consejos de seguridad y cuidado**

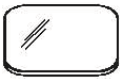
- Antes de comenzar a ensamblar este producto, asegúrese de contar con todas las partes necesarias.
- Es conveniente ensamblar este producto sobre una superficie suave para no raspar el acabado.
- Límpielo con un paño seco o ligeramente húmedo. No utilice productos químicos.
- Debe tenerse cuidado al sentarse sobre el mueble con algún objeto cortante (herramientas de jardinería y cuchillos) en sus bolsillos, ya que pueden desgarrar las telas y penetrar el tejido de resina, lo que lo dañará irreparablemente
- Recomendamos guardar los muebles cuando no estén en uso para prolongar su vida útil

ASSEMBLY INSTRUCTIONS

A	 Table Leg	4PCS
B	 Table Fixed Frame	2PCS
C	 Table Top	1PC
D	 Bolt M6*25	16PCS
E	 Washer	16PCS
F	 Hex Key	1PC
G	 Screw	4PCS

STEP 1

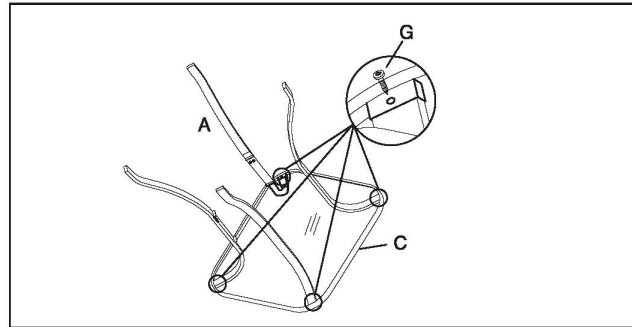

STEP 2

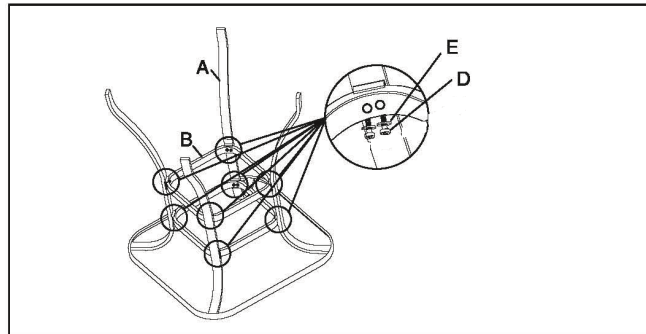







STEP 3

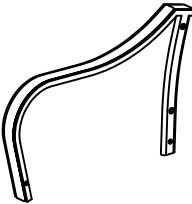
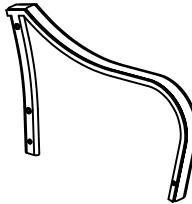
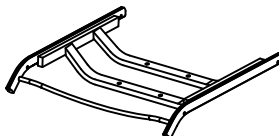
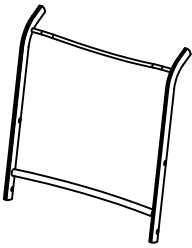
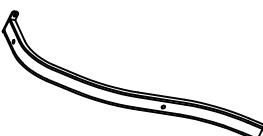
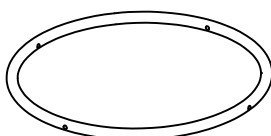

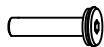
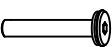
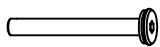
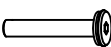
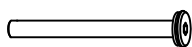
Packing List

PF19273-1-2.0

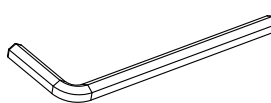
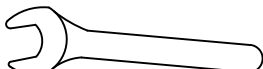
				
A 2pcs	B 2pcs	C 2pcs	D 2pcs	
			 M6*18	
E 8pcs	F 2pcs	G 2pcs	Aa 8+2pcs	
 M6*25	 M6*30	 M6*23	 M6*48	 Ø13*Ø6.5*1.0
Bb 8+2pcs	Cc 16+4pcs	Dd 8+2pcs	Ee 8+2pcs	Ff 48+6pcs
 M6				
Gg 24+6pcs	Hh 32+6pcs	Ii 8+2pcs	Jj 1pc	Kk 1pc

WARNING:











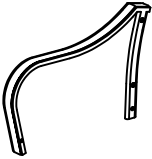
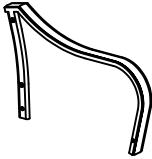

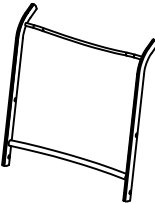
Cushions must be put away in rainy and windy days in case they are diminished or blown away.

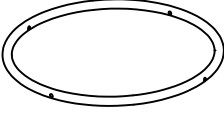
ASSEMBLY TIPS: Please use the hardware and accessories included in the set. DO NOT use other electrical or manual tools. In order to facilitate the assembly and make your final product firm and stable, please tighten by a few rounds each screw one by one. After all screws are connected, then you start to tighten each screw to the end.

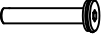
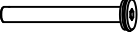
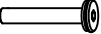
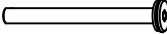
DO NOT tighten any screw to the end before you have connected all screws.

The assembly requires minimal level of DIY skills if you follow the instructions carefully. In case you encounter any difficulty or have any questions, feel free to contact the store or manufacturer.

ASSEMBLY INSTRUCTIONS PF19273-1-2.0

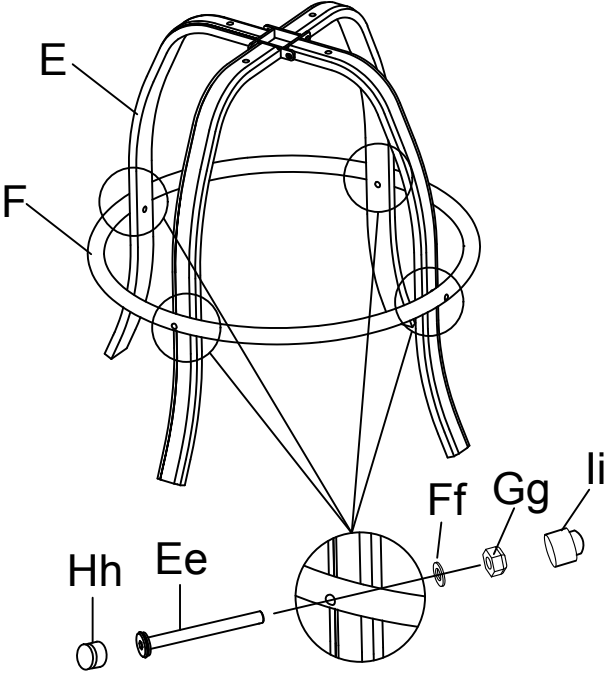
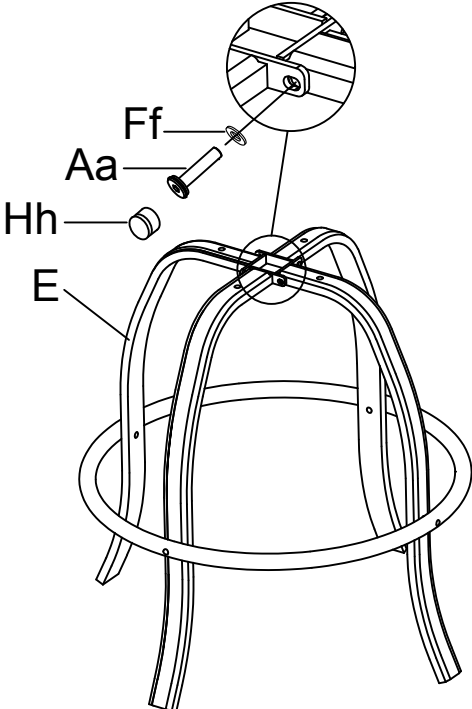
					
A 1pc	B 1pc	C 1pc	D 1pc	E 4pcs	F 1pc
					
G 1pc	Aa 4pcs	Bb 4pcs	Cc 8pcs	Dd 4pcs	Ee 4pcs
 Ø13*Ø6.5*1.0T					
Ff 24pcs	Gg 12pcs	Hh 16pcs	li 4pcs	Jj 1pc	Kk 1pc
1					
2					

ASSEMBLY TIPS:

Please use the hardware and accessories included in the set. DO NOT use other electrical or manual tools. In order to facilitate the assembly and make your final product firm and stable, please tighten by a few rounds each screw one by one. After all screws are connected, then you start to tighten each screw to the end. DO NOT tighten any screw to the end before you have connected all screws. The assembly requires minimal level of DIY skills if you follow the instructions carefully. In case you encounter any difficulty or have any questions, feel free to contact the store or manufacturer.

ASSEMBLY INSTRUCTIONS PF19273-1-2.0

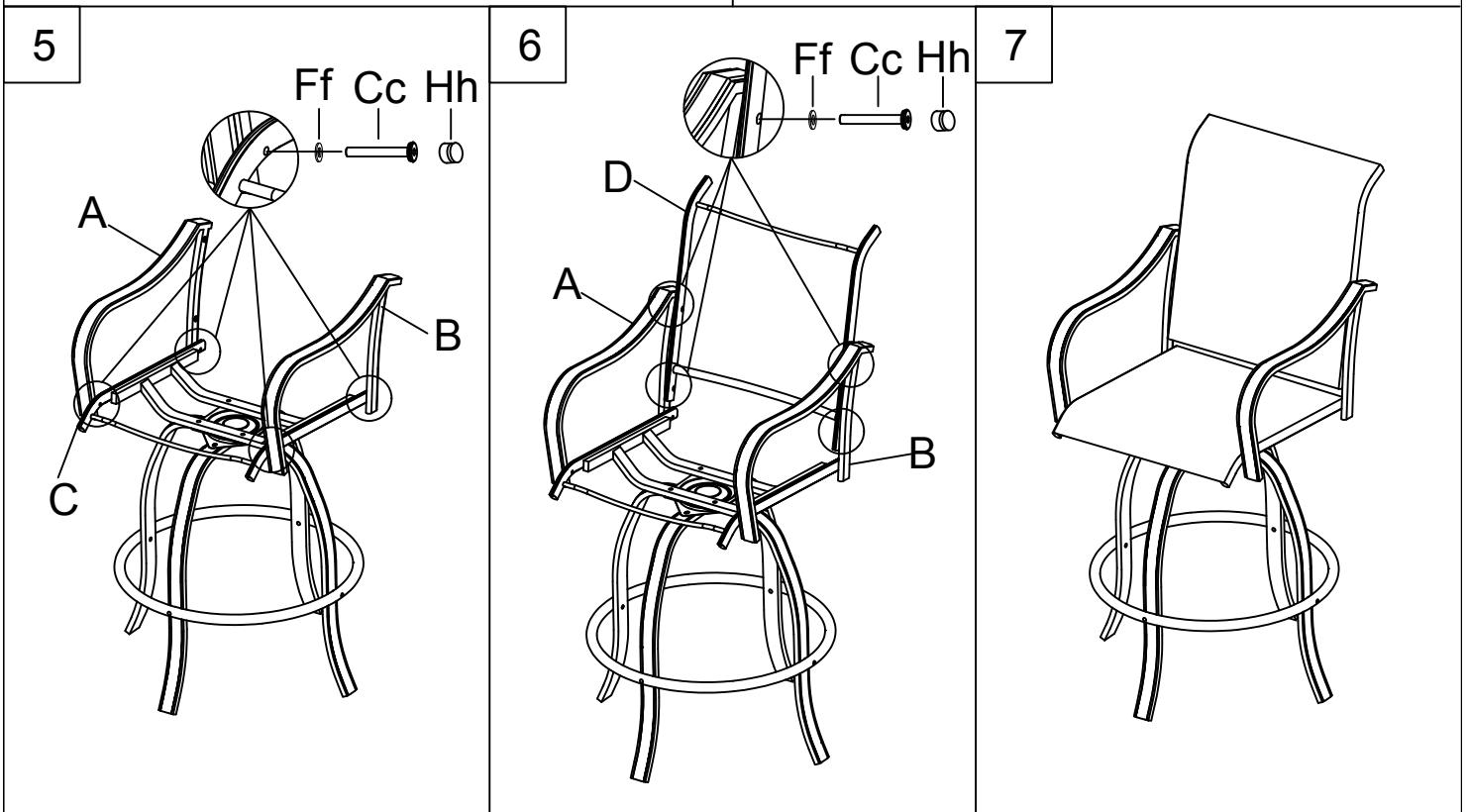
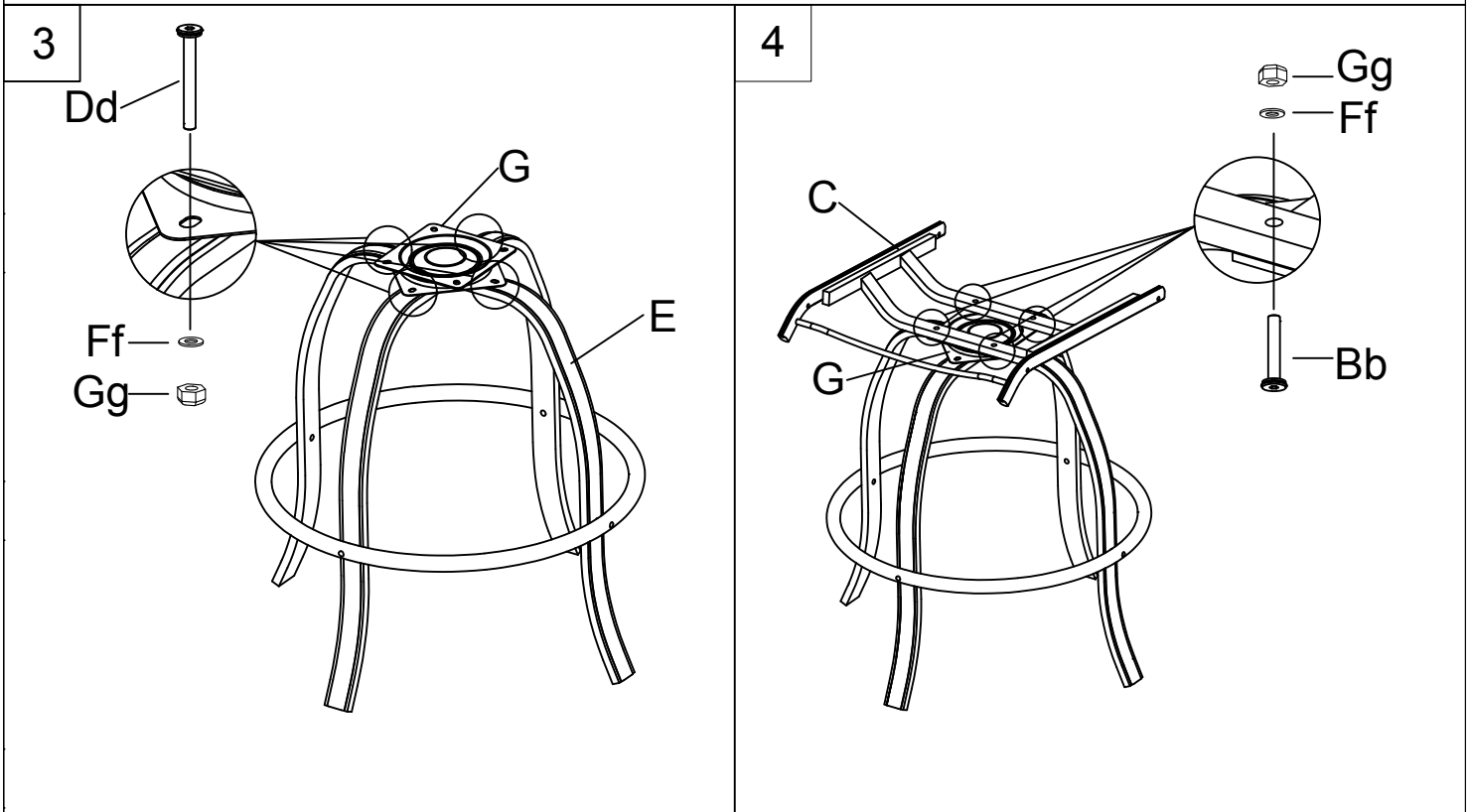

ASSEMBLY TIPS:

Please use the hardware and accessories included in the set. DO NOT use other electrical or manual tools. In order to facilitate the assembly and make your final product firm and stable, please tighten by a few rounds each screw one by one. After all screws are connected, then you start to tighten each screw to the end. DO NOT tighten any screw to the end before you have connected all screws. The assembly requires minimal level of DIY skills if you follow the instructions carefully. In case you encounter any difficulty or have any questions, feel free to contact the store or manufacturer.