

VP Process Inc 2620 Rev A

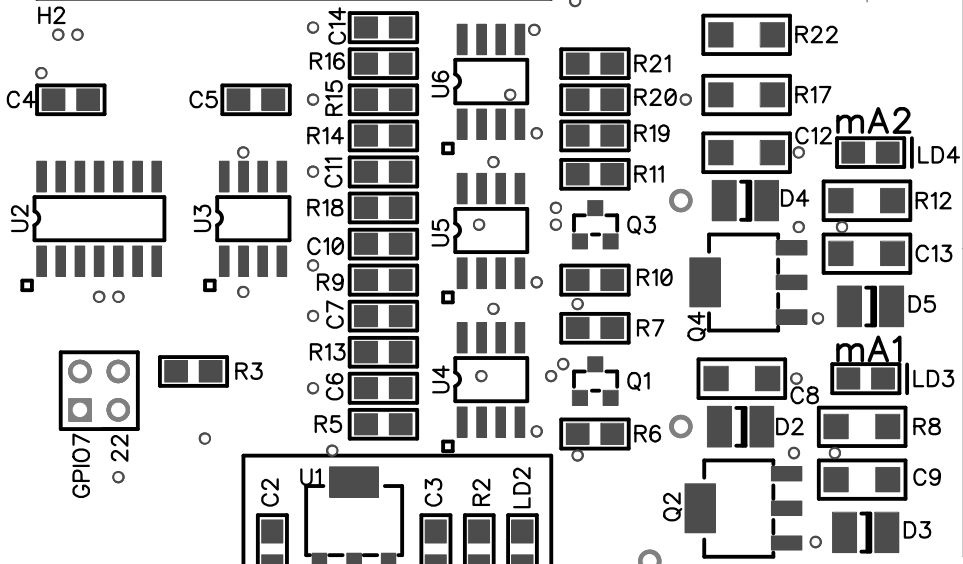

Pi-Spi
2A0 Out

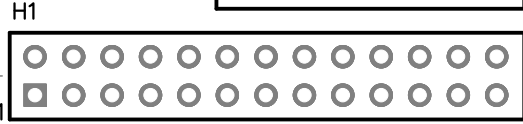
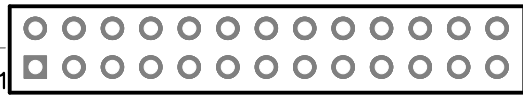
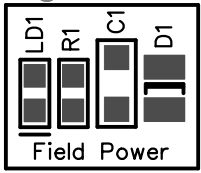
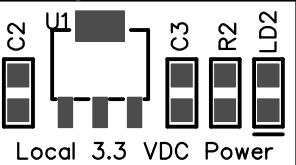
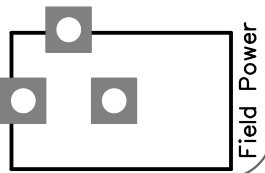
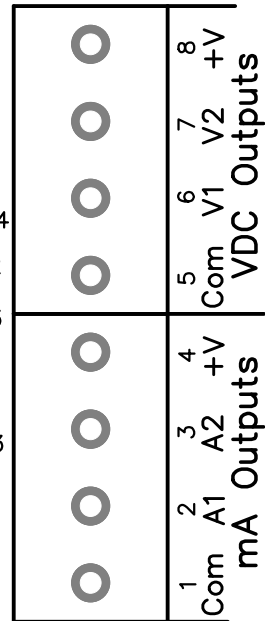

1	2	3	4	5	6	7	8
Com	A1	A2	+V	Com	V1	V2	+V
mA Outputs				VDC Outputs			

Field Power