

Please read this manual carefully before installation and keep it for future reference.

Installation & Owner's Manual



MRCOOL®

COMFORT MADE SIMPLE

U-Shaped Window Unit Air Conditioner Model: MWUC**5

Due to updates and constantly improving performance, the information and instructions within this manual are subject to change without notice. Please visit www.mrcool.com/documentation to ensure you have the latest version of this manual.

Version Date: 7-23-21

Please keep this manual where the operator can easily find it. Inside, you will find helpful hints on how to use and maintain your unit properly.

Contents

!	Safety Precautions	2
	General Warnings	2
	Cautions	4
	Warning Regarding Current Detection Device	5
	Warnings (for using R290/R32 refrigerant only)	6
1	Installation Instructions	12
2	Sounds During Normal Operation	24
3	Air Conditioner Operation & Features	25
4	Care & Cleaning	29
5	Troubleshooting Tips	30

Cooling Operation	Outdoor temp:	64°F-109°F (18°C-43°C)
	Indoor temp:	60°F-90°F (16°C-32°C)

NOTE: This air conditioner is designed to be operated in the conditions in the table below. If the unit is operated outside of these temperatures its performance could be reduced. The relative humidity of the room should be less than 80%. If the unit is operated in an environment with a relative humidity above 80%, there will be condensed water on surface of the unit.

Safety Precautions



Important: Read This Manual Entirely Before Using Incorrect usage may cause serious damage or injury.

This manual is intended to not only assist you with installation of your new air conditioning unit, but also provide you with helpful hints on how to properly use and maintain the air conditioner. By following the tips provided in this manual, you can save a great deal of time and money over the life of your air conditioner. Should you experience any problems, please refer to the troubleshooting section of this manual before you attempt to contact technical support. There you will find the answers or solutions to many common problems that could make contacting technical support unnecessary.

In order to prevent property damage and personal injury, you must follow all of the instructions fully and be aware of all of the warnings, cautions, and notes defined in this manual. Improper or incorrect operation caused by ignoring these could cause harm to yourself and others, as well as property damage.

The seriousness of potential damage or injuries is classified as either a **WARNING** or **CAUTION**.



WARNING

This symbol indicates that ignoring instructions may cause death or serious injury.









CAUTION

This symbol indicates that ignoring instructions may cause moderate injury to your person, damage to your unit, or other property.





This symbol indicates that you should **NEVER** perform the indicated action.

WARNING

- Ensure plug is securely inserted into the outlet. If not, it could cause electrical shock or fire due to excess heat generation
-  **DO NOT** start or stop operation of the unit by inserting or pulling the plug from the outlet. Make sure the unit is switched off before plugging or unplugging it from the outlet, otherwise it could cause electric shock or fire due to heat generation.
-  **DO NOT** modify the length of the power cord or allow any other appliances to share the outlet with the unit. It could cause electric shock or fire due to heat generation.
-  **DO NOT** use a damaged or unspecified power cord. It could cause electric shock or fire. If the power cord is damaged, it must be replaced by the manufacturer or an authorized service center in order to avoid a potential hazard.
- Always install a dedicated power circuit and circuit breaker. Improper or incorrect installation could cause fire and/or electric shock.
-  **DO NOT** operate the unit with wet hands, or in a damp environment in order to avoid the potential of electric shock.
-  **DO NOT** direct airflow directly at room occupants, as this could be harmful to their health.
- Ensure the unit is securely and effectively grounded in order to prevent the potential for electric shock.
-  **DO NOT** allow water to enter the electric parts of the unit, as this could cause electric shock and/or failure of the unit.
-  **DO NOT** open the unit while it is operating, as this could cause electric shock.

WARNING

-  **DO NOT** use a socket that is damaged or loose, as it could cause electric shock.
 - If the unit makes strange or abnormal noises, emits an odor, or smoke begins to appear, stop operation and unplug the unit immediately. It could cause electric shock and/or fire.
-  **DO NOT** allow the power cord to be near heating appliances, or flammable gas and combustibles (ex: gasoline, benzene, thinner, etc.), as these could cause a fire and/or explosion.
 - Always ventilate the room before operating the air conditioner. If there is gas leaking from another appliance, it could cause an explosion, fire, and/or personal injury that could include burns.
-  **DO NOT** disassemble or modify the unit, as this could cause the unit to fail and/or electric shock.

For Your Safety

-  **DO NOT** store or use gasoline, or any other flammable vapors and liquids, in the vicinity of this or any other appliance.



Prevent Accidents

To reduce the risk of fire, electric shock, or personal injury when using the unit, follow these precautions:













- Ensure the electrical service of where the unit is being installed is adequate for the model of air conditioner you are installing. This information can be found on the serial plate of the unit, which is located on the side of the cabinet behind the grille.
- If the unit is to be installed in a window, be sure to clean the area before the installation, and remove the screen if the window is equipped with one.
- When handling the air conditioner, be careful to avoid being cut by the sharp metal fins on the front and rear coils.
- Ensure that this air conditioner has been correctly and securely installed according to the installation instructions contained within this manual. Be sure to save this manual. It may be needed in the future for removing or reinstalling this unit.

Electrical Information

The complete electrical rating information of this unit can be found on the serial plate. Refer to this rating when checking electrical requirements. Follow these requirements:

- Ensure the air conditioner is properly grounded in order to minimize the chance of electric shock and/or fire. The power cord is equipped with a three-prong grounded plug as means of protection against shock hazards.
 - The unit must be used with a properly grounded wall outlet. If the wall outlet to be used is not properly grounded, protected by a time delay fuse, or a circuit breaker, have a qualified electrician install the proper outlet. Also make sure that the receptacle is accessible after the unit installation.
 - Aluminum house wiring may present special problems, please consult a qualified electrician.
-  **DO NOT** operate the unit without the side protective cover in place. Operating the unit without this, could result in mechanical failure within the unit.
 -  **DO NOT use an extension cord or adapter plug.**

CAUTION

-  **DO NOT** touch the metal parts of the unit while the air filter is removed or personal injury could occur.
-  **DO NOT** allow pets or house plants to be exposed to direct airflow from the unit, it could cause harm or injury.
-  **DO NOT** use in a room that is not well ventilated, especially when used in a room with a stove as this could cause an oxygen shortage.
-  **DO NOT** use strong detergent, such as wax or thinner, to clean the unit. These could discolor or scratch the surface of the unit and deteriorate the overall appearance.
-  **DO NOT** clean the unit with water or while the unit is on. Water could enter the unit and degrade the insulation and increase the possibility of injury, electric shock, and/or fire. When the unit is to be cleaned, turn off the unit and turn off the power at the circuit breaker. Use a soft cloth to clean it.
-  **DO NOT** use this air conditioner to preserve precision devices, food, pets, plants, and/or art, as this could deteriorate the quality of those items.
-  **DO NOT** operate the unit during a storm or hurricane. Stop operation and close windows. Operation with windows opened may cause indoor furniture to become saturated with water.
 - Periodically ensure the mounting bracket of the unit is not damaged due to prolonged exposure to the outdoor elements. If the bracket is damaged, it could weaken its capacity and increase the chance of the unit falling.
-  **DO NOT** operate the unit without filters, as this could cause the unit to fail. The filters should be cleaned every two weeks. When installing the filters, ensure they are inserted securely.
-  **DO NOT** remove the plug from an outlet by pulling on the cord. Always grab the head of the plug when removing it from the outlet. Otherwise, it could cause electric shock or damage to the cord.
-  **DO NOT** block the air-inlets or inside of the air outlet of the unit with objects or obstacles. These could cause an accident, or failure of the unit.
-  **DO NOT** allow heavy objects to rest on top of the power cord, and ensure it has not become compressed, as this could cause electric shock and/or fire.
-  **DO NOT** consume any water any water drained from the air conditioner. It contains contaminants that could be harmful to your health.
 - When the unit is not going to be used for an extended period of time, turn off the main power switch.
 - Use caution when unpacking and installing the unit, as the components could have sharp edges which could cause injury.
 - In the event water enters the unit, turn off the unit at the power outlet and switch off the circuit breaker. Remove the power plug and contact a qualified service technician.
 - This appliance is not intended for use by individuals (including children) with reduced physical, sensory or mental capabilities, or a lack of experience and knowledge, unless they are given instruction or supervision concerning the use of the appliance by a person responsible for their safety.
 - Children should be supervised to ensure they are not playing with the appliance.
 - If the power cord is damaged, it must be replaced by the manufacturer, its service agent, or a similarly qualified person in order to avoid a hazard.
 - The appliance should be installed in accordance with national wiring regulations.
-  **DO NOT** operate your air conditioner in a room where it could be exposed to water, such as a bathroom or laundry room.
 - Contact the authorized service technician for repair or maintenance of this unit.



WARNING REGARDING CURRENT DETECTION DEVICE

The power cord of this air conditioner contains a current detection device that is designed to reduce the risk of fire by sensing if there is damage to the cord. In the event that the power supply cord is damaged, it cannot be repaired and it must be replaced with a cord from the product manufacturer.

In order to test this function and the cord, follow these steps:

- 1.) Plug the air conditioner into the wall outlet.
- 2.) The plug head of the power cord will have two buttons, TEST and RESET. Press the TEST button and you will notice a click as the RESET button pops out.
- 3.) Press the RESET button and you will notice a click as the button engages.
- 4.) The power supply cord is now active and supplying power to the unit. Some products may indicate this with a light on the head of the plug.

Please note the following warnings in regards to the use of this device:



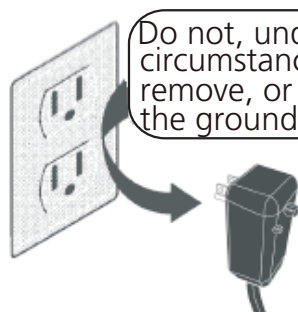

- ⊘ ***DO NOT*** use this device to turn the unit ON or OFF.
 - Always ensure the RESET button is pushed in for correct operation of the device.
 - If the device fails to reset when the TEST button is pushed, or it cannot be reset, the power cord must be replaced. If a new cord is needed, it can be obtained from the product manufacturer.
 - If the power supply cord is damaged, it cannot be repaired. It **MUST** be replaced by one obtained from the product manufacturer.
- ⊘ ***DO NOT*** use an extension cord or an adapter plug in order to avoid electric shock or a fire hazard.
- ⊘ ***DO NOT*** remove any prong from the power cord.

Grounding type wall receptacle



Power supply cord with 3-prong grounding plug and current detection device.

WARNING (for using R290/R32 refrigerant only)

-  **DO NOT** use any other methods to clean or defrost the unit than those recommended by the manufacturer.
 - The appliance should be stored in a room that does not contain continuously operating ignition sources (ex: open flames, an operating electric heater, or an operating gas appliance), and ignition sources (ex: an operating electric heater) close to the appliance.
-  **DO NOT** Pierce or burn.
 - Be aware some refrigerants may not contain an odor, so leakage could be difficult to detect.
 - When working with refrigerant, compliance with local and national gas regulations should be observed.
 - Be sure to keep ventilation openings clear of obstructions.
 - The appliance should be stored in such a way to prevent mechanical damage from occurring. It should also be in a well-ventilated area with a room size that corresponds to the room area specified for operation.
 - Any individual who is involved with working or tapping into a refrigerant circuit should hold a current and valid certificate from an industry-accredited assessment authority, which authorizes their competence to safely handle refrigerants in accordance with an industry recognized assessment.
 - Servicing should only be performed as recommended by the equipment manufacturer. Maintenance and repair requiring the assistance of other skilled personnel shall be carried out under the presence and supervision of the person qualified in the use of flammable refrigerants.
-  **DO NOT** modify the length of the power cord or use an extension cord to power the unit.
-  **DO NOT** share a single outlet with other electrical appliances, as improper power supply could cause electric shock and/or fire.
 - R32 Refrigerant is used within this air conditioner, which is classified as being flammable. Please follow the instructions carefully when handling, installing, clearing, or servicing the air conditioner in order to avoid any damage or potential hazards. When maintaining or disposing of the unit, the refrigerant (R32 or R290) will need to be recovered properly and not directly discharged into the air.
-  **DO NOT** have any open flames or any type of switch, which is capable of generating a spark or arching, near the air conditioner which could ignite the flammable refrigerant within the unit.

IMPORTANT: Read this manual fully before attempting to install or operate this unit. Make sure to save this manual for future reference. For units that use R32/R290 refrigerant, please be aware of the symbols below that will displayed on the unit are to inform and alert you of potential hazards. Please read the descriptions below for further detail.







CAUTION: Risk of fire/flammable materials (Required for R32/R290 units only).



IMPORTANT NOTE: Read this manual carefully before installing or operating this unit. Save this manual for future reference.

Explanation of symbols displayed on the unit (because this unit uses R32/R290)

	WARNING	This symbol shows that this appliance uses a flammable refrigerant. If the refrigerant leaks and is exposed to an external ignition source, there is a risk of fire.
	CAUTION	This symbol shows that the operation manual should be read carefully.
	CAUTION	This symbol shows that service personnel should be handling this equipment while referencing the installation manual.
	CAUTION	This symbol shows that information is available in the operating or installation manual.

WARNING (for using R290/R32 refrigerant only, continued)

1. Transport of equipment containing flammable refrigerants

Refer to transport regulations.

2. Marking of equipment using signs

Refer to local regulations.

3. Disposal of equipment using flammable refrigerants

Refer to national regulations.

4. Storage of equipment/appliances

The storage of equipment should be in accordance with the manufacturer's instructions.

5. Storage of packed (unsold) equipment

Storage packaging should include protection that is constructed in such a way that mechanical damage to the equipment inside the package will not cause a leak of the refrigerant charge. The maximum number of pieces of equipment permitted to be stored together will be determined by local regulations.

6. Information on Servicing

6.1) Check the area: Prior to beginning work on systems containing flammable refrigerants, it is necessary to perform safety checks in order to ensure that the risk of ignition is minimized. When repairing the refrigerating system, the following precautions should be read and followed before performing work on the system.

6.2) Work Procedure: Work should follow procedures in order to minimize the risk of a flammable gas or vapor being present while the work is being performed.

6.3) General Work Area: All maintenance staff and others working in the local area should be informed of the type of work being performed. Performing work in confined spaces should be avoided. Also, ensure that the conditions within the area are safe and free of flammable material.

6.4) Checking For The Presence of Refrigerant: The area where work is being performed should be checked for refrigerant with an appropriate refrigerant detector prior to and during work. This is to ensure the technician is aware if there is any flammable refrigerant in the air around the work area.

6.5) A Fire Extinguisher Should Be On Hand: If any work is performed on the refrigeration equipment, or any associated parts, where heat could be created, an appropriate fire extinguisher (dry powder or CO₂) should be available and adjacent to the charging area.

6.6) No Sources of Ignition: No individual performing work on the refrigeration system, which involves exposing pipe work that contains or has contained flammable refrigerant should not use any sources of ignition in a manner that could lead to an explosion and/or fire. All possible ignition sources (ex: cigarette smoking) should be kept a sufficiently far distance from the site of installation, repair, removal and disposal, during which flammable refrigerant could possibly be released into the atmosphere. Prior to performing any work, the area around the equipment is to be surveyed to ensure there are no flammable hazards or risks of ignition. No smoking signs should be displayed.

6.7) Ventilated Area: Ensure that the work space is in the open or adequately ventilated before beginning work on the system, or performing any work that could generate heat. A degree of ventilation should continue while work is being performed, as it should safely disperse any released refrigerant and preferably expel it into the atmosphere.

6.8) Check the Refrigeration Equipment: When electrical components are being changed, they should be of the correct specification for the unit they are being installed on. The manufacturer's maintenance and service guidelines should be followed at all times. If in doubt, please contact the manufacturer's technical department for assistance. The following checks should be performed to installations using flammable refrigerants:



WARNING (for using R290/R32 refrigerant only, continued)

- The amount of charge is in accordance with the size of the room which the refrigerant containing parts are installed.
- The ventilation machinery and outlets are operating sufficiently and are not obstructed.
- If an indirect refrigerant circuit is being used, the secondary circuit needs to be checked for the presence of refrigerant.
- Markings and signs on the unit are still visible and legible. If they are not, make them visible and legible for future reference.
- Refrigeration piping or components are installed in a location where they are unlikely to be exposed to any corrosive substances that could corrode and damage any of the refrigerant containing components. Unless, the components are constructed of anti-corrosive materials, or are suitably protected from corrosion.

6.9) Check the Electrical Components: Repair and maintenance to electrical components should include initial safety checks and component inspection procedures. If a fault exists, that could compromise safety, then the electrical supply should not be connected to the circuit until the issue has been resolved. If the fault cannot be immediately corrected, but it is necessary to continue operation, an adequate, temporary solution should be used. This should be reported to the owner of the equipment so all parties are aware and advised of the issue. Initial safety checks should include the following:

- All capacitors are discharged: this should be performed in a manner that is safe in order to avoid the possibility of sparking.
- No live electrical components and wiring are exposed during charging, recovering, or purging the system.
- Ensure the system is securely and properly grounded.

7. Repairs to Sealed Components

7.1) During repairs to sealed components, all electrical supplies should be disconnected from the equipment being worked on before removing any sealed covers, etc. If it is necessary to have an electrical supply connected to the equipment during service, then a permanent, continually-operating form of leak detection should be located at the most critical point to warn of any potentially hazardous situations.

7.2) Close attention should be paid to the following when working on electrical components:

- Ensure the casing is not altered in such a way that the level of protection is affected. This includes damage to the cables, excessive number of connections, terminals that do not meet original specification, damage to seals, incorrect fitting of glands, etc.
- Ensure the device is mounted securely.
- Ensure the seals, or sealing materials, have not degraded to the point they no longer have the ability to seal. Replacement parts should be in accordance with the manufacturer's specifications.

NOTE: The use of silicone sealant may inhibit the effectiveness of some types of leak detection equipment. Intrinsically safe components do not have to be isolated prior to working on them.



WARNING (for using R290/R32 refrigerant only, continued)

8. Repair to Intrinsically Safe Components

DO NOT apply any permanent inductive or capacitance loads to the circuit without ensuring that the permissible voltage current permitted for the equipment in use will not be exceeded. Intrinsically safe components are the only types of components that can have worked performed on them while live and in the presence of a flammable atmosphere. The test apparatus should be at the correct rating. Ensure any components that need to be replaced are only replaced with parts specified by the manufacturer. If specified parts are not used, it could result in the ignition of refrigerant from a leak.

9. Cabling

Ensure cabling will not be subject to wear, corrosion, excessive pressure, vibration, sharp edges, or any other adverse environmental effects. You should also take into account the effects of aging or continual vibration from sources such as compressors or fans.

10. Detection of Flammable Refrigerants

DO NOT use potential sources of ignition (ex: halide torch, or any other detector which uses an open flame) while attempting to search for or detect refrigerant leaks.

11. Leak Detection Methods

The following methods of leak detection have been deemed acceptable for systems containing flammable refrigerants. Electronic leak detectors should be used to detect flammable refrigerants, however, the sensitivity may not be adequate, or it could need recalibration. If recalibration is needed, it should be calibrated in a refrigerant-free environment. Ensure the detector is not a potential source of ignition, and is suitable for the type of refrigerant used. Leak detection equipment should be set at a percentage of the LFL of the refrigerant, and should be calibrated to the refrigerant used and the appropriate percentage of gas (25% maximum) is confirmed. Leak detection fluids are suitable for use with most refrigerant, but the use of detergents containing chlorine should be avoided, because the chlorine could react with the refrigerant and cause the copper piping to corrode. If a leak is suspected, any open flames should be removed or extinguished from the area. If a leak is found, which will require brazing, all of the refrigerant should be recovered from the system, or isolated (by shutting off the valves) in a part of the system that is separated from the leak. Oxygen Free Nitrogen (OFN) should then be purged through the system before and during the brazing process.

12. Removal and Evacuation

When it is needed to enter the refrigerant circuit to make repairs, or for any other purpose, conventional procedures should be used. However, it is important to follow the best practice because of the flammable properties of the refrigerant. Opening refrigerant systems should not be completed by brazing. Use the following steps:

- 1.) Remove refrigerant
- 2.) Purge the circuit with inert gas
- 3.) Evacuate the system
- 4.) Purge the circuit again with inert gas
- 5.) Enter the circuit by cutting or brazing

The refrigerant should be recovered into the correct recovery cylinders. The system should be flushed with OFN to render the unit safe. This process may need to be repeated several times.

DO NOT use compressed air or oxygen for this task.



WARNING (for using R290/R32 refrigerant only, continued)

Flushing should be achieved by breaking the vacuum in the system with OFN and continuing to fill until working pressure is achieved. Then, vent it into the atmosphere, before finally pulling down to a vacuum. This process should be repeated until no refrigerant is present in the system. When the final OFN charge is used, the system should be vented down until reaches atmospheric pressure to enable work to be performed. This operation is vital if brazing is needed to make repairs. Ensure that the outlet for the vacuum pump is not close to any potential ignition sources and it has adequate ventilation available.

13. Charging Procedures

In addition to conventional charging procedures, the following requirements should be followed:

- Ensure contaminations of different refrigerants does not occur when using charging equipment.
- Hoses or lines should be as short as possible to minimize the amount of refrigerant contained within them.
- Cylinders should be kept upright.
- Ensure that the refrigeration is grounded prior to charging the system with refrigerant.
- Label the system when charging is complete (if it is not already).
- Extreme care should be taken to not overfill the refrigeration system.
- Prior to recharging the system, it should be pressure tested with OFN. The system should be leak tested upon completion of charging, but prior to decommissioning. A follow up leak test should performed prior to leaving the site.

14. Decommissioning

Before completing the decommissioning process, it is essential that the technician is completely and thoroughly familiar with all aspects of the equipment. It is recommended and good practice to recover all refrigerants safely. Prior to completing this task, an oil and refrigerant sample should be taken in case analysis is required prior to re-use of the reclaimed refrigerant. It is essential that electrical power is available before this task can be completed. Following these steps:

- 1.) Become familiar with the equipment and its operation.
- 2.) Isolate the system electrically.
- 3.) Before attempting this procedure, ensure the following:
 - a.) Mechanical handling equipment is available, if required, for handling refrigerant cylinders.
 - b.) All personal protective equipment is available and being used correctly.
 - c.) The recovery process is supervised at all times by a qualified person.
 - d.) Recovery equipment and cylinders conform to the appropriate standards.
- 4.) Pump down refrigerant system, if possible.
- 5.) If a vacuum is not available, construct a manifold so that the refrigerant can be removed from various parts of the system.
- 6.) Ensure that the cylinder is positioned on the scales before recovery takes place.
- 7.) Start the recovery machine and ensure it is operated in accordance with the manufacturer's instructions.
- 8.) ***DO NOT*** overfill the cylinders (no more than 80% volume liquid charge).
- 9.) ***DO NOT*** exceed the maximum working pressure of the cylinder, not even temporarily.



WARNING (for using R290/R32 refrigerant only, continued)

- 10.) Once the cylinders have been filled correctly and the process has been completed, ensure that the cylinders and equipment are removed from the site promptly, and all isolation valves on the equipment are closed off.
- 11.) The recovered refrigerant should not be charged into another refrigeration system until it has been cleaned and checked.

15. Labeling

Equipment should be labeled to state that it has been decommissioned and emptied of any and all refrigerant. The label should be dated and signed. Ensure that there are still labels on the equipment that states the equipment contains flammable refrigerant.

16. Recovery







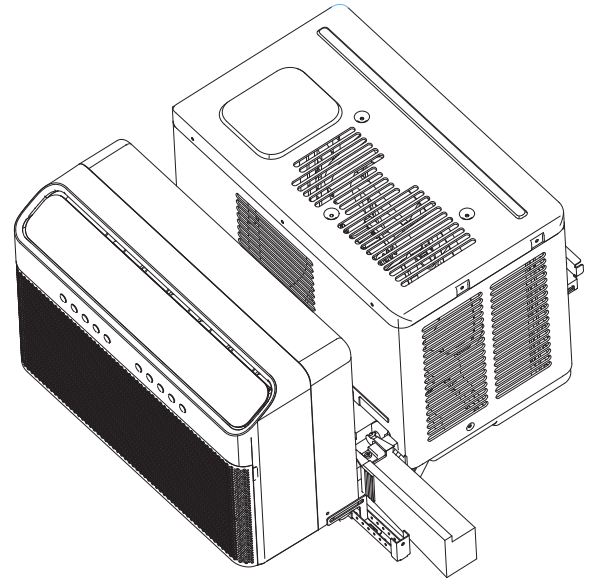
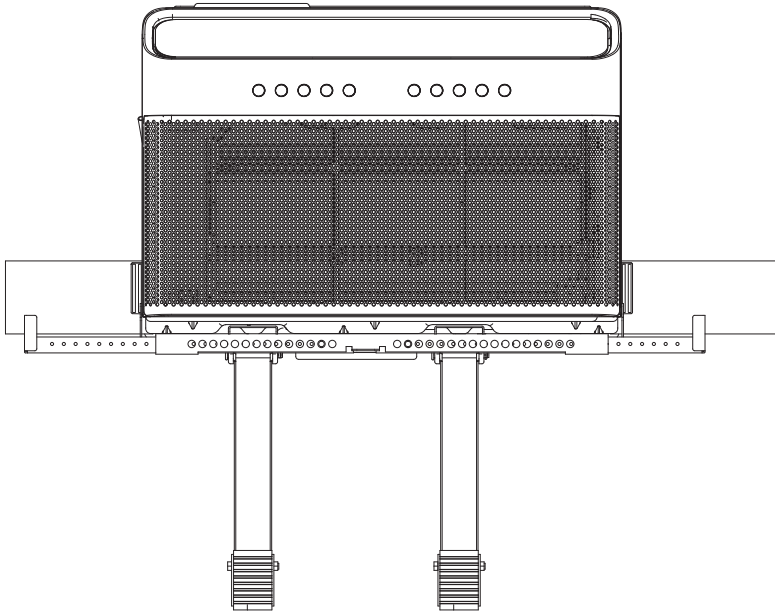







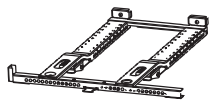

When removing refrigerant from a system, either for servicing or decommissioning, it is recommended, and good practice, to ensure all refrigerants are removed safely. When transferring refrigerant into the cylinders, ensure that only appropriate refrigerant recovery cylinders are used. Also, ensure that the correct number of cylinders, for holding the total system charge, are available. All cylinders to be used are designated for the specific type of refrigerant to be recovered and labeled for that refrigerant (i.e. special cylinders for the recovery of refrigerant). Cylinders should be complete with a pressure relief valve and associated shut-off valves which should be in good working order. Empty recovery cylinders are evacuated and cooled before recovery occurs (if possible).

The recovery equipment should also be in good working order, with a set of instructions concerning the specific equipment that is on hand, and that is suitable for the recovery of flammable refrigerant. In addition, a set of calibrated weighing scales should be available and in good working order. Hoses should be complete with leak-free disconnect couplings and in good condition. Before using the recovery machine, ensure that it is in good working order, has been properly maintained, and that any associated electrical components are sealed (to prevent ignition in the event of a refrigerant release). Consult manufacturer if in doubt.

The recovered refrigerant should be returned to the refrigerant supplier in the correct recovery cylinder, and the relevant Waste Transfer Note arranged. **DO NOT** mix refrigerants in recovery units and especially not in cylinders. If compressors or compressor oils are to be removed, ensure that they have been evacuated to an acceptable level to make certain that flammable refrigerant is not present within the lubricant. The evacuation process should be carried out prior to returning the compressor to the suppliers. Only electric heating to the compressor body should be employed to accelerate this process. When oil is drained from a system, it should be done so safely.

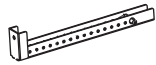

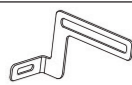
Installation Hardware

	Type B 1/2" Screw	2*		Window Sash Lock	1
	Type B 1/4" Screw	2*		Additional Side Arm Foam	2
	Type A 1/2" Screw	3*		Window Sealing Foam	1
	Type A 1" Screw	2*		Bracket Sealing Foam	1
	Main Bracket	1		Side Arm Foam	2
	Right Extension Arm (For 26"-36" windows)	1		Window Sash Foam	1
	Right Extension Arm - Short (For 22"-26" windows)	1	<p>*Denotes extra hardware provided in separate bag.</p> <p>NOTE: If any piece of hardware is missing, <i>DO NOT</i> INSTALL THE PRODUCT, and call customer service.</p>		
	Main Support Pin	2*			
	Cotter Pin	2*			
	Open Window Bracket - LH	1			
	Open Window Bracket - RH	1			

NOTE: The unit you purchased will look similar to one of the images above. Please note that all of the illustrations in this manual are for explanation purposes only. The air conditioner you have may be slightly different in terms of size and shape.

Installation Instructions



BEFORE YOU BEGIN

Read these instructions completely and carefully.

- **IMPORTANT-** Save these instructions for local inspector's use.
- **IMPORTANT-** Ensure installation follows all local and state codes and ordinances.
- **Note to Installer-** Be sure to leave these instructions with the consumer.
- **Note to consumer- Keep these instructions for future reference.**
- **Skill level-** Installation of this appliance requires basic mechanical skills.
- **Completion time-** Approximately 1 hour.
- **We recommend that two people install this product.**
- **Proper installation is the responsibility of the installer.**
- **Product failure due to improper installation is not covered under the Warranty. You MUST use only the parts supplied, along with proper installation procedures as described in this manual, when installing this air conditioner.**

TOOLS YOU WILL NEED

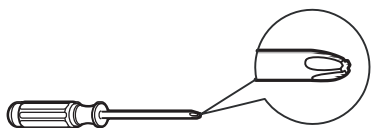

Phillips
Screwdriver



Level



Flat Head
Screwdriver



Pencil

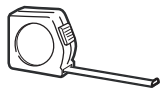

Ruler or tape
measure



Scissors or knife

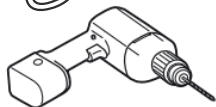

Drill and
1/8" drill bit



Proper PPE



WINDOW REQUIREMENTS

Your air conditioner is designed to install in standard double hung windows, with opening widths of 22 to 36 inches (559 mm to 914 mm) and a window height of 13.5 inches (343 mm). Before you begin the installation, ensure the window you have selected meets this requirement.

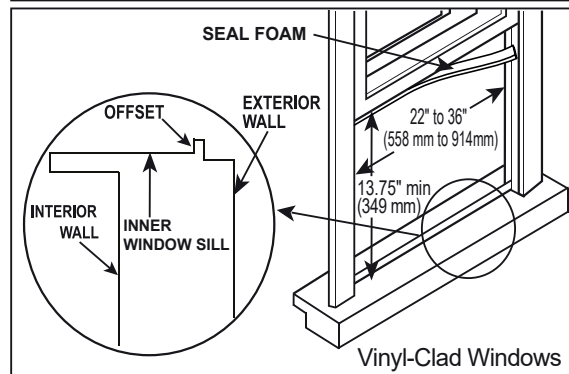
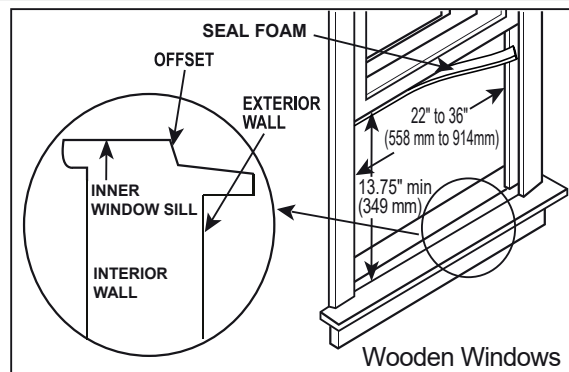

PREPARE THE WINDOW

The lower portion of the window (sash) must be able to open enough to allow a vertical opening of 13.75 inches (349.25 mm). The rear of the A/C and side louvers must have no obstructions and clean air around them to allow enough airflow to flow through the condenser, for heat removal. The rear of the unit must be outdoors, not inside a building or garage. Find the center of your window and lightly mark it with a pencil.

NOTE:

Save the carton/box the air conditioner came in as well as these Installation Instructions for future reference. The carton/box is the best way to store the unit during winter, or when not in use.

Installation Instructions

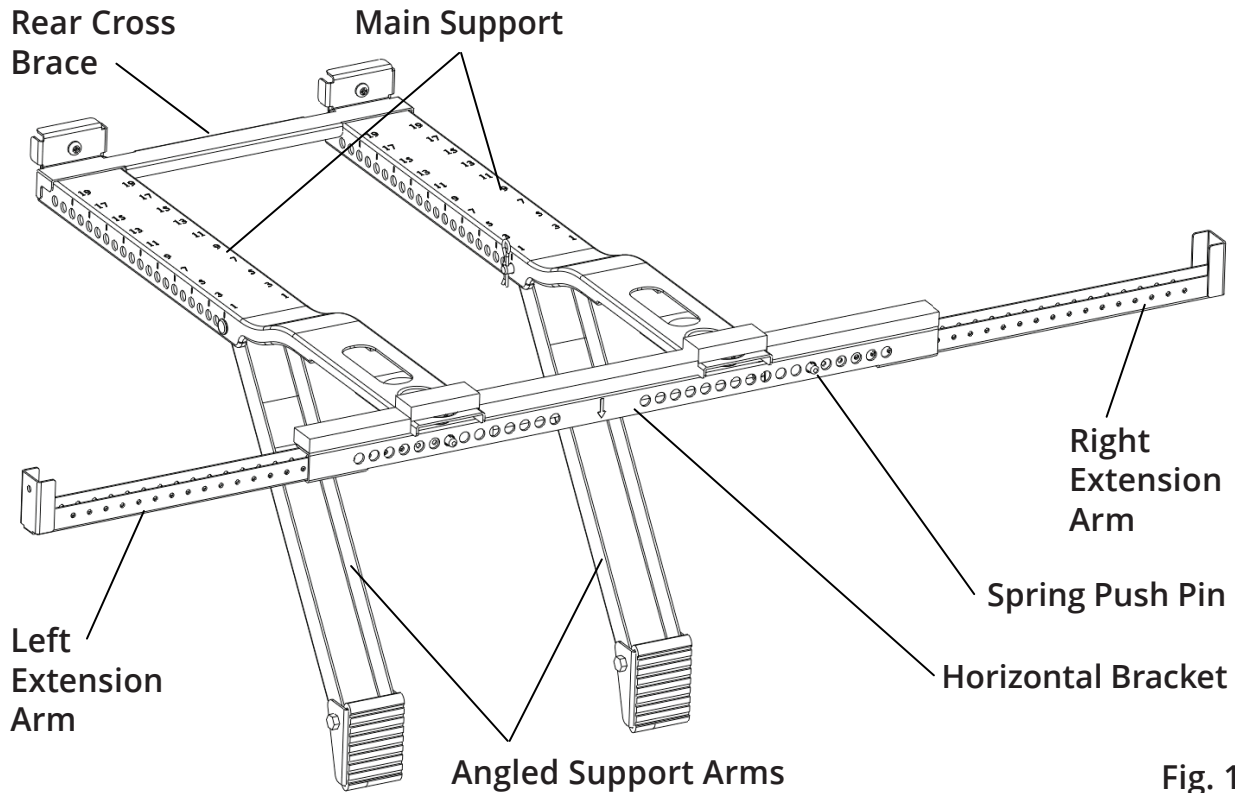

Fig. 1

2 PREPARE THE MOUNTING BRACKET

A. Remove the air conditioner, bracket, and hardware components from the carton and lay them on a flat surface.

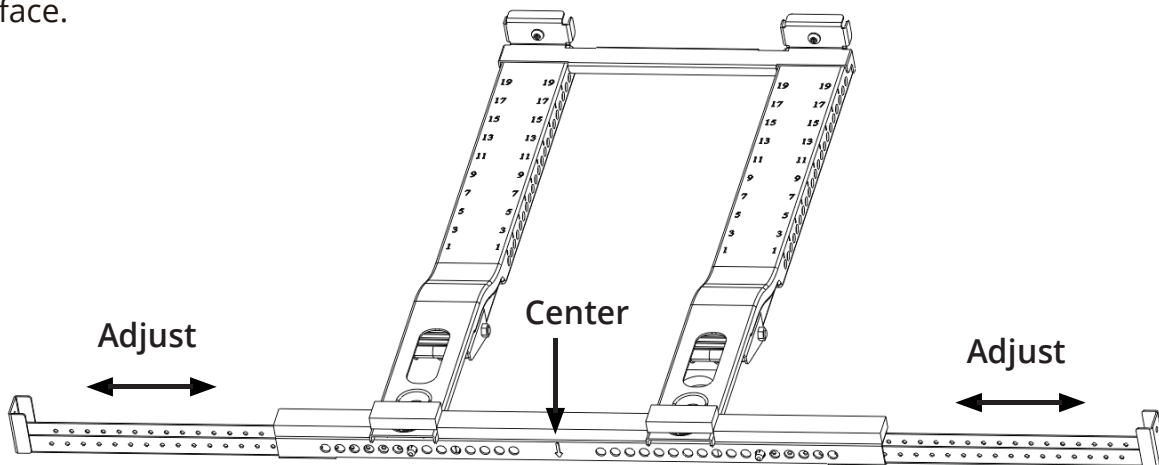

Fig. 2

B. Press spring-loaded push pin of the **Left Extension Arm** located on the **Horizontal Bracket** and adjust the arm outward. Then, install the **Right Extension Arm** into the right side of the **Horizontal Bracket**. Please refer to **Fig. 2**.

C. Now, measure the width of the inner windowsill of the window the unit is to be installed in. Align the mark on the center of the **Horizontal Bracket** with the center of the window you marked with a pencil earlier. Next, adjust the arms of the bracket to the measured width of the windowsill by pressing the spring-loaded push pins to adjust the arms inward or outward. **NOTE: the bracket will be offset to the left when installed.**

Installation Instructions

D. Now, you will apply the supplied **Bracket Sealing Foam** strips to the bottom of the bracket as depicted in **Fig. 3**.

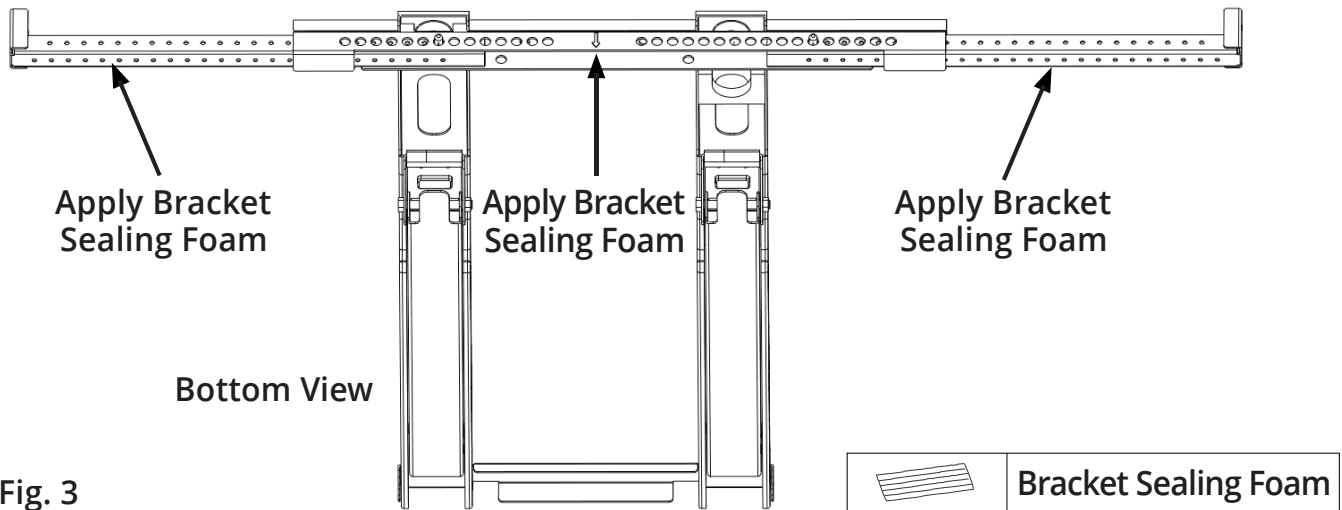

Fig. 3

3 INSTALL SUPPORT BRACKET

A. Install the **Main Support Bracket** into the window opening. Ensure that the **Horizontal Bracket** and the **Left and Right Extension Arms** are located on the indoor side of the window. Please refer to **Fig. 4**.

⚠ WARNING

Maintain control of the bracket until installation is complete.

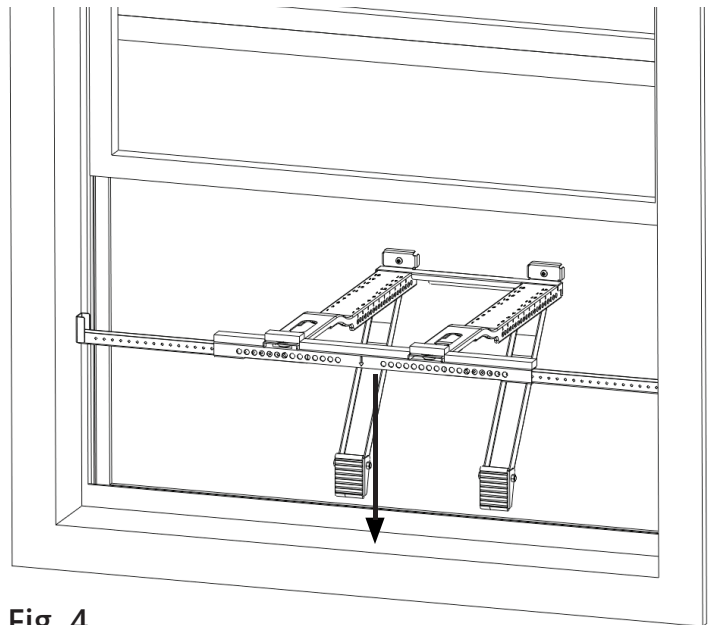

Fig. 4

A1. Depending on the type of window you plan to install the unit in (wooden or vinyl-clad), the bracket will sit differently in the base of the windowsill. Please refer to **Fig. 5**.

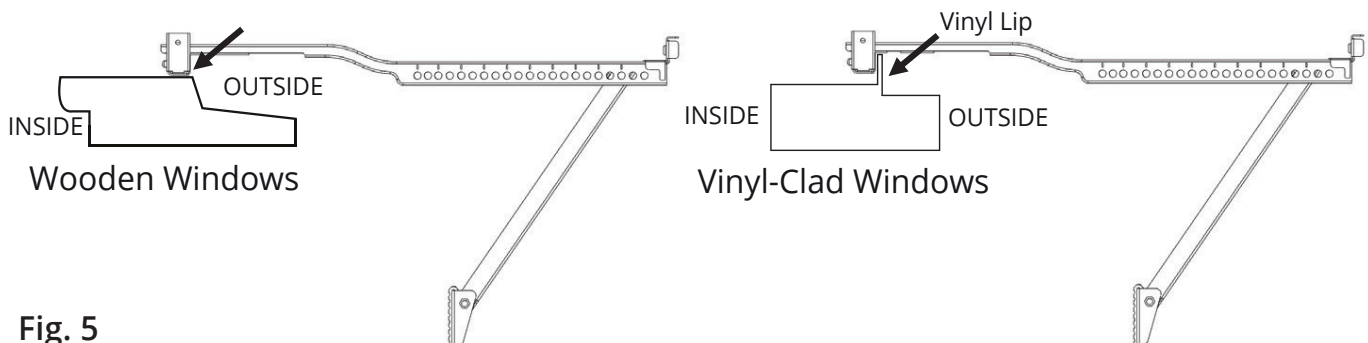
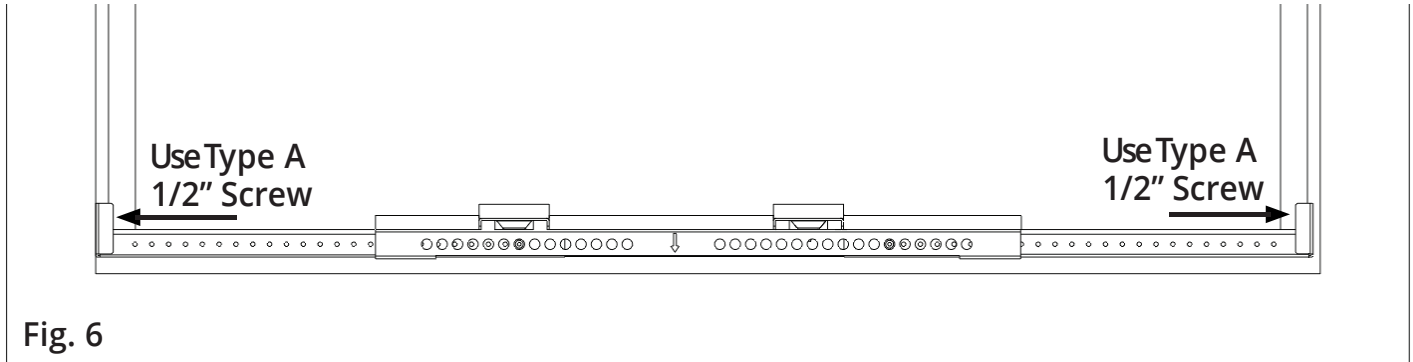

Fig. 5

Installation Instructions

For Vinyl Type Windows with a Lipped Seal

A2. Secure the bracket to the windowsill by drilling 1/8 in (3.175 mm) pilot holes through the holes of the vertical portion of the bracket and into the windowsill, refer to the arrows in the image below. Then, install the supplied **Type A 1/2" screws** (12.7 mm) into the vertical portion of the bracket and windowsill, as shown in **Fig. 6** below.



For Wooden Type Windows with a Flat Seal

A3. Secure the bracket to the windowsill by drilling 1/8 in (3.175 mm) pilot holes through the holes of the bracket and into the windowsill, refer to the arrows in the image below. Then, install the supplied **Type A 1/2" screws** (12.7 mm) into the vertical portion of the bracket and windowsill, and the **Type A 1" screws** (25.4 mm) into the horizontal portion of the bracket and base of the windowsill, as shown in **Fig. 7** below.

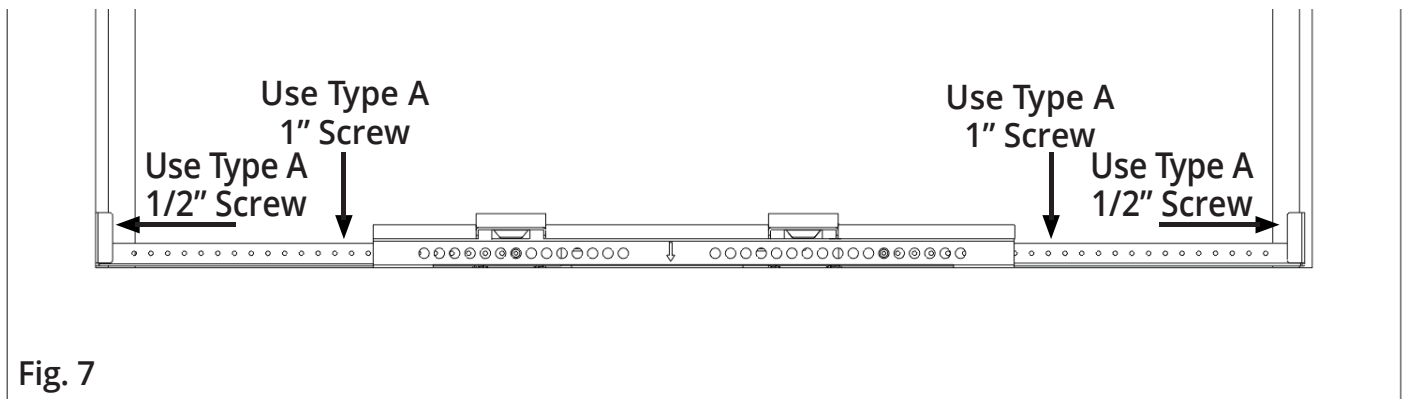

B. Moved the **Angled Support Arms** toward the exterior wall until the feet touch the wall. Place the level on the **Main Supports** of the bracket and adjust the **Support Arms** that it is tilted slightly downward toward the outside of the window. This will allow for proper condensate drainage of the unit. Please refer to **Fig. 8**.

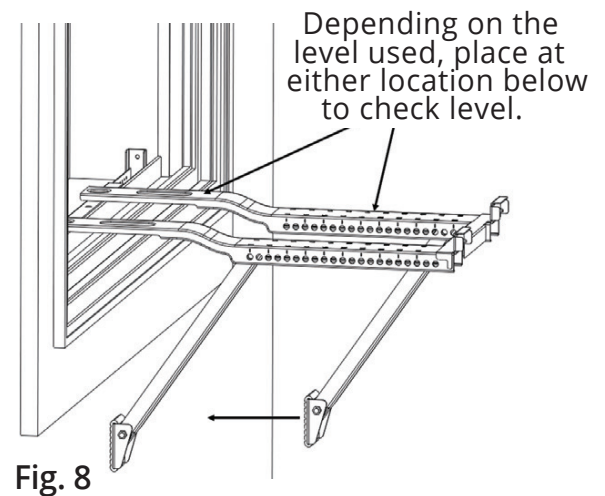
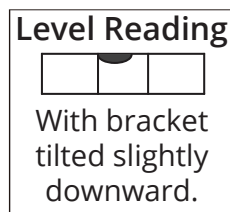

Installation Instructions

C. Once the bracket has been adjusted to desired level, insert the **Main Support Pin** through the holes of the **Main Support** and **Angled Support Arm**. Using the numbers on the **Main Support**, repeat the adjustment for the other **Angled Support Arm** (matching the hole and number from first support arm). Please refer to **Fig. 9**.

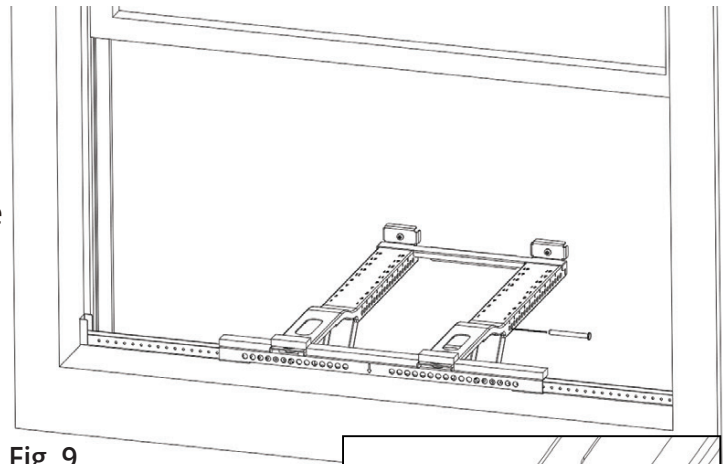
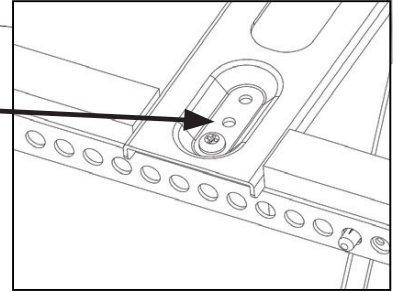

Fig. 9

NOTE: If further adjustment is needed, use the alternate holes where the Main Supports attach to the Horizontal Bracket.



D. Check the level again and ensure the bracket and arms are secure. After making any necessary adjustments, insert the **Cotter Pins** into the holes of the **Main Support Pins**, as shown in **Fig. 10**.

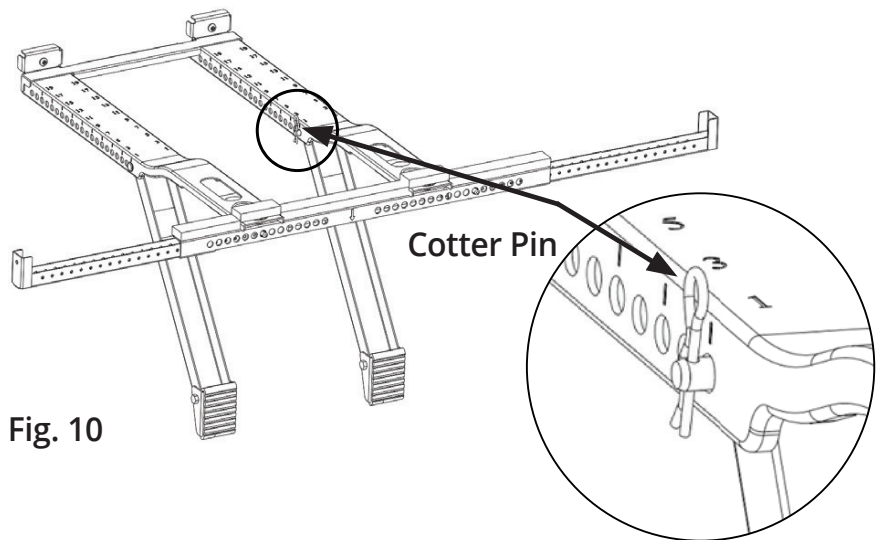

Fig. 10

E. If necessary, cover the holes on the front of the bracket with the **Bracket Sealing Foam**, as shown in **Fig. 11**.

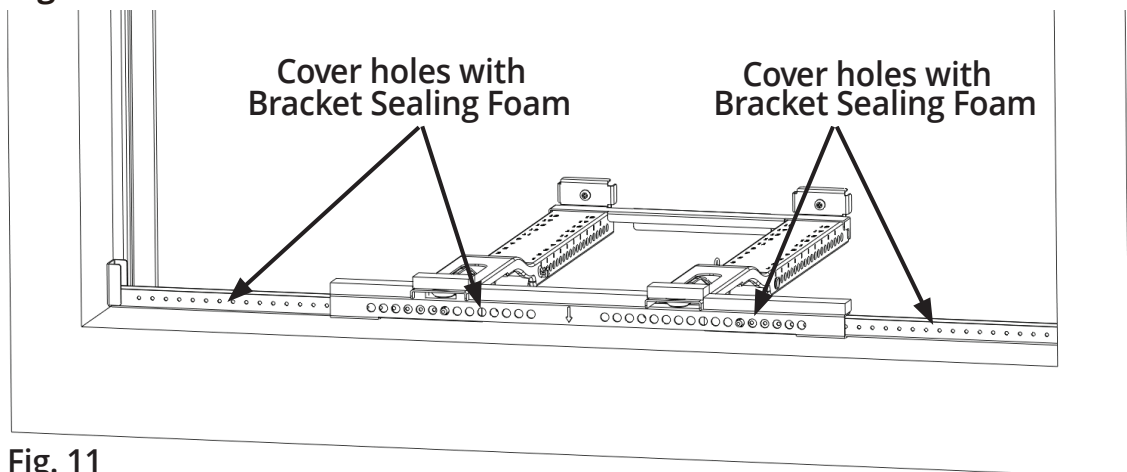

Fig. 11

4 INSTALL AIR CONDITIONER TO BRACKET

! IMPORTANT

Before proceeding to the next step, measure the width of your window track (the vertical track your window slides up and down in) before installing your air conditioner. If it is 1/2 in (12.7 mm) or less, flip the Anti-Tip Bracket so the small end faces out, then continue with the installation. Refer to the image to the right.

! WARNING

DO NOT leave the unit unattended during the installation

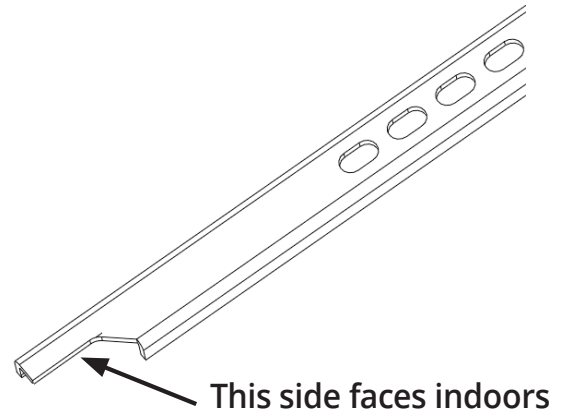

A. Set the air conditioner on top of the support bracket. Ensure the grooves on the bottom of the air conditioner align with the **Main Supports**. Please refer to **Fig. 12 & Fig. 13** below. Using a level, ensure that the unit has the proper amount of tilt towards the outside.

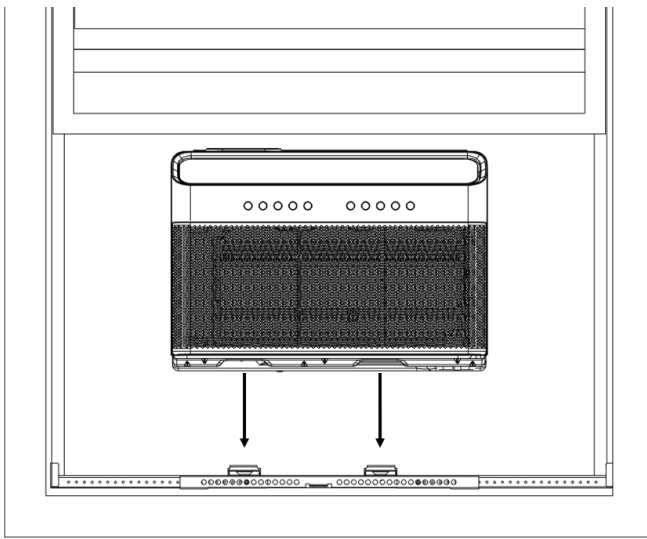

Fig. 12

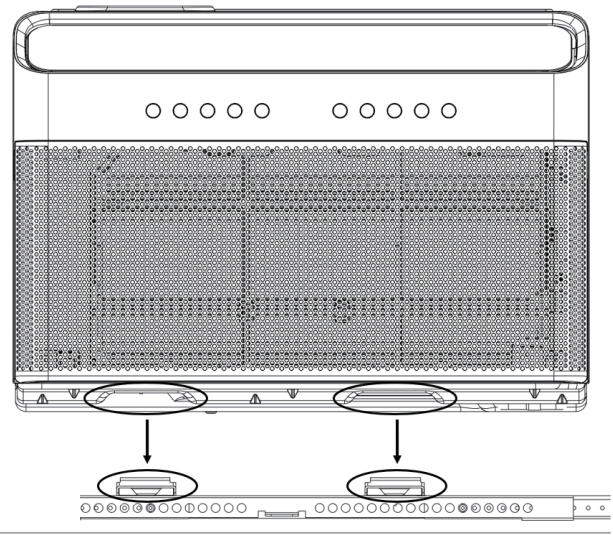

Fig. 13

B. Now, pull the window down into the slot to help align and position the unit into the correct location. Keep the window partially inserted into the window slot to help support the air conditioner during the installation. Then, fold down the **Side Arm Hinges** on both sides of the unit. Please refer to the **Fig. 14 & Fig. 15** below.

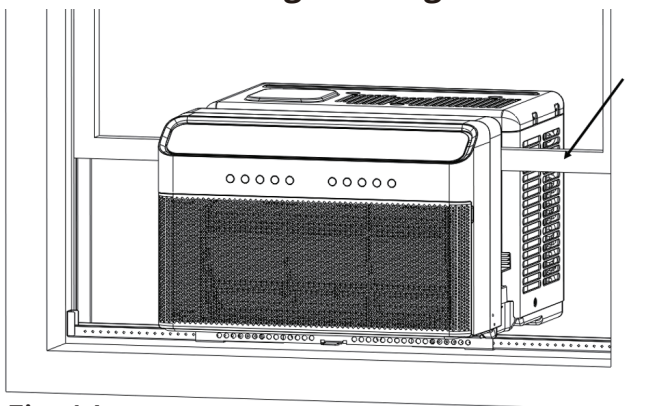

Fig. 14

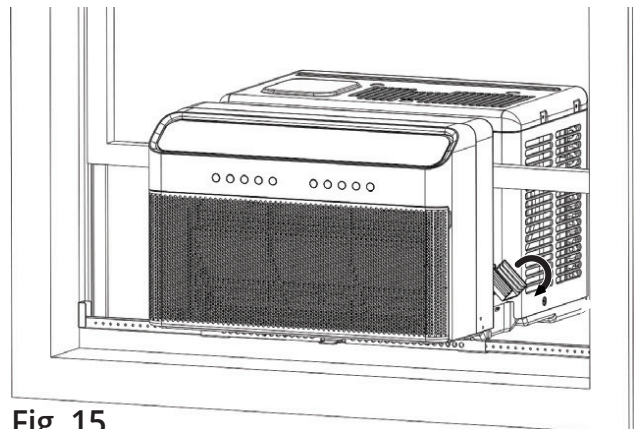

Fig. 15

Installation Instructions

C. Next, you must install the **Open Window Brackets** on each side of the unit. Use the **Type B 1/4" screws** (6.35 mm) for the portion of the bracket that attaches to the **Horizontal Bracket** and the **Type B 1/2" screws** (12.7 mm) for the portion of the bracket that attaches to the unit itself. Please refer to **Fig. 16**.

! WARNING

Failure to install the Open Window Brackets could cause injury or property damage.

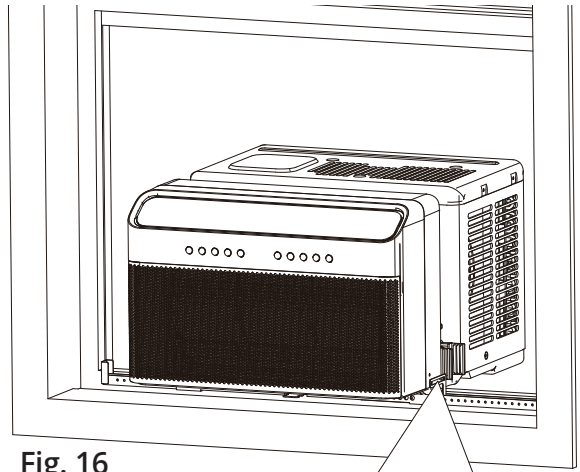
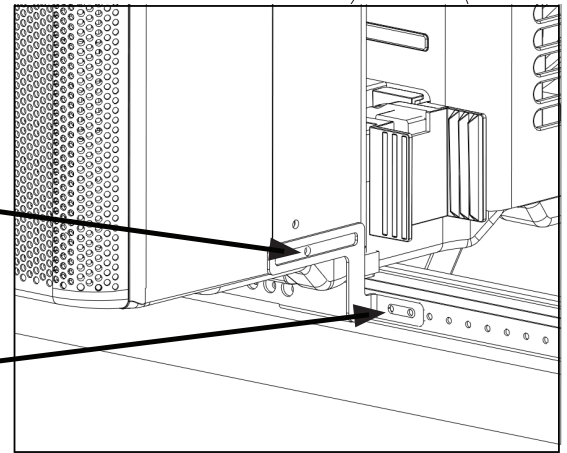

Fig. 16

Use the Type B
1/2" Screw

Use the Type B
1/4" Screw



5 FOAM INSTALLATION

A. Measure the distance between the **Side Arm Hinge** and the closest part of the window frame in line with the **Side Arm**. Please refer to the images to the right. Add 1/4 in (6.35 mm) to this measurement and cut the **Side Arm Foam** to this length. Please refer to **Fig. 17**.

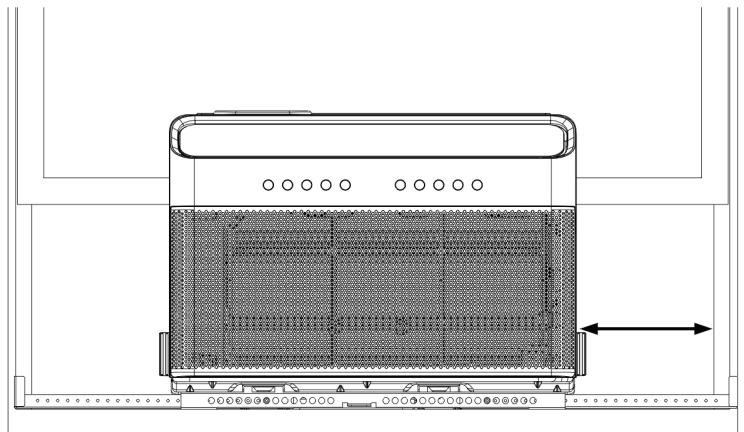
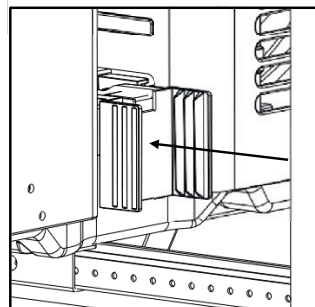

Fig. 17



Installation Instructions

B. In this step, depending on the type of window the unit is being installed in (vinyl or wooden), you will apply **Window Sealing Foam** to the **Side Arm Foam** as shown **Fig.18 & Fig. 19**. Please note that the **Window Sealing Foam** attaches to the side next to the air conditioner.

Vinyl Type Windows with Lipped Sill

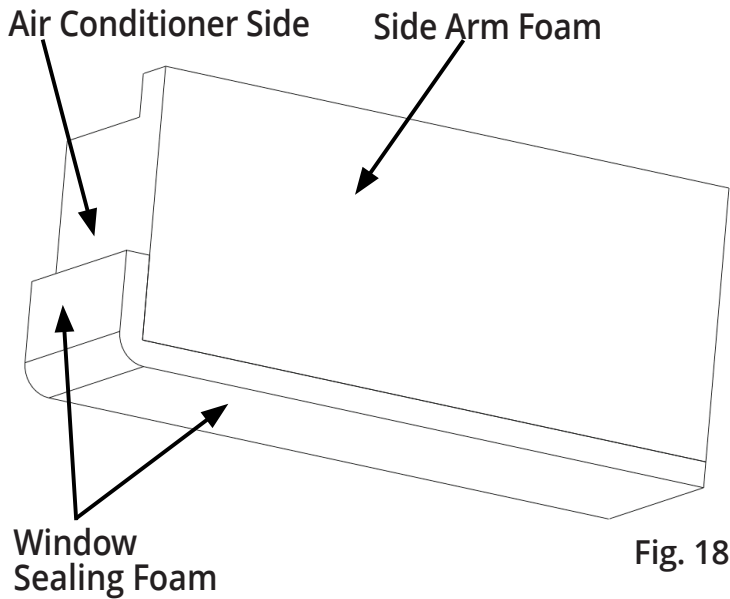

Wooden Type Windows with Flat Sill

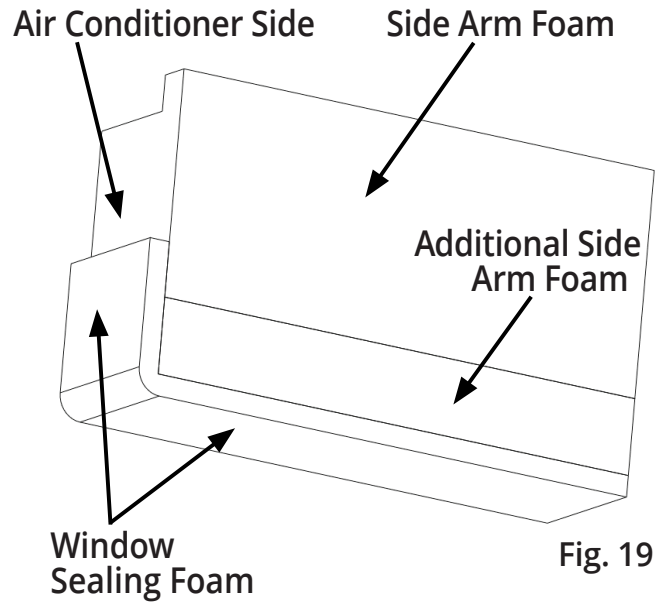

C. Insert the **Side Arm Foam** into **Side Arm Hinge** until the top front of the **Side Arm Foam** is flush with the top of the hinge. Please refer to **Fig. 20** below. Then, repeat these steps for installing the **Side Arm Foam** on the other side of the unit.

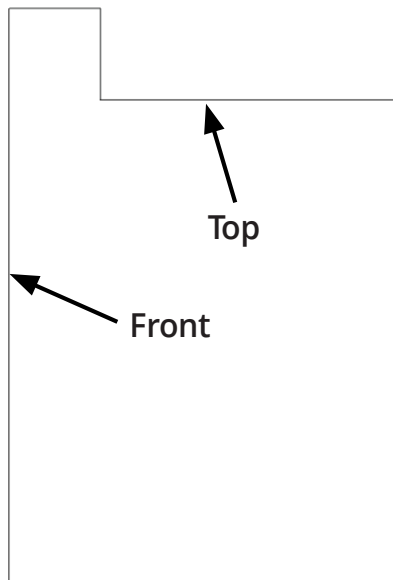

Side View of Side Arm Foam

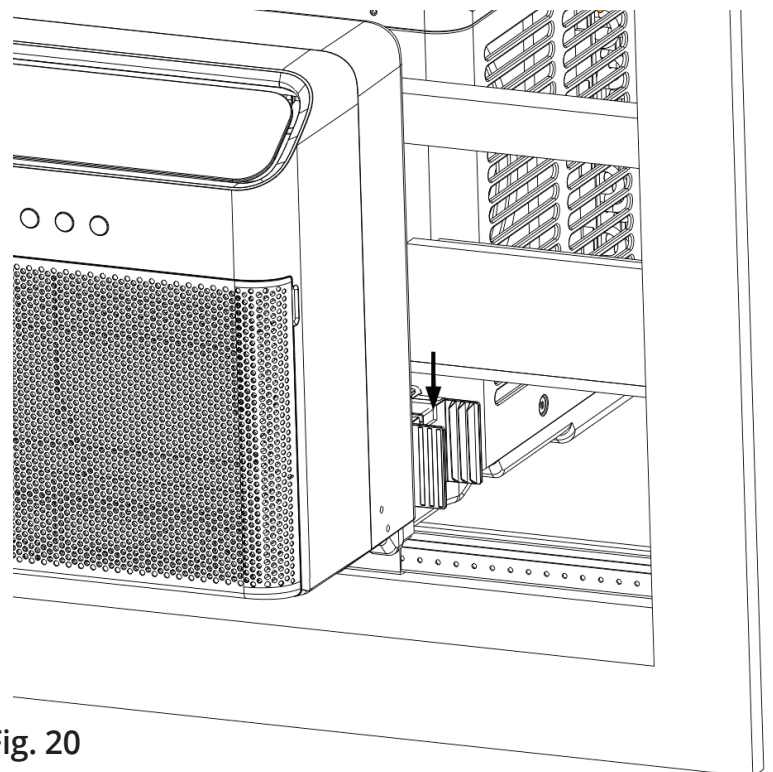

Installation Instructions

D. The **Anti-Tip Brackets** must be extended into the window track opening (the vertical track your window slides up and down in) until it stops and sits against the face of the window track. In order to make this adjustment you must remove the factory-installed 1/2" Phillips head screw from each bracket. Once the adjustments have been made, secure the brackets in place by reinstalling the screws you originally removed. Please refer to the images below.

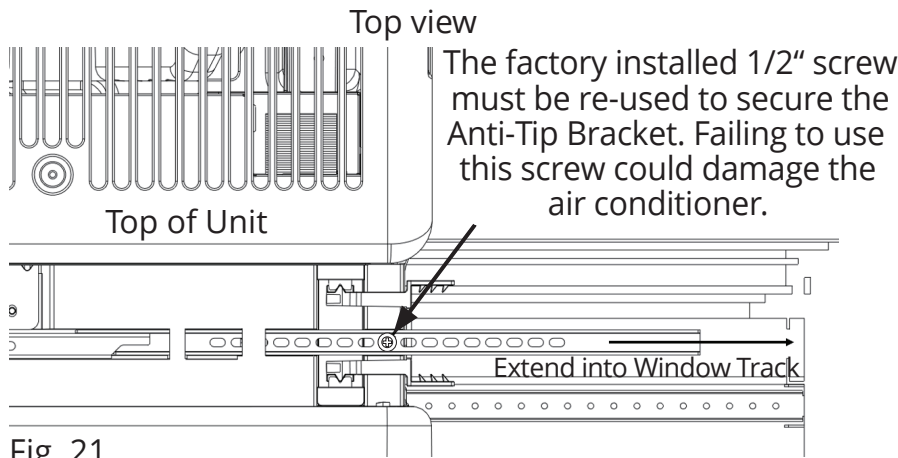

! WARNING

The Anti-Tip Brackets must be extended into the window track opening. Failure to follow this warning could result in serious injury and/or property damage.

Fig. 21

NOTE: Fig. 22 & Fig. 23 below are to show how the Anti-Tip Bracket is to be installed in the window track. Note: the Side Arm Foam installed in the previous steps is not shown in this illustration.

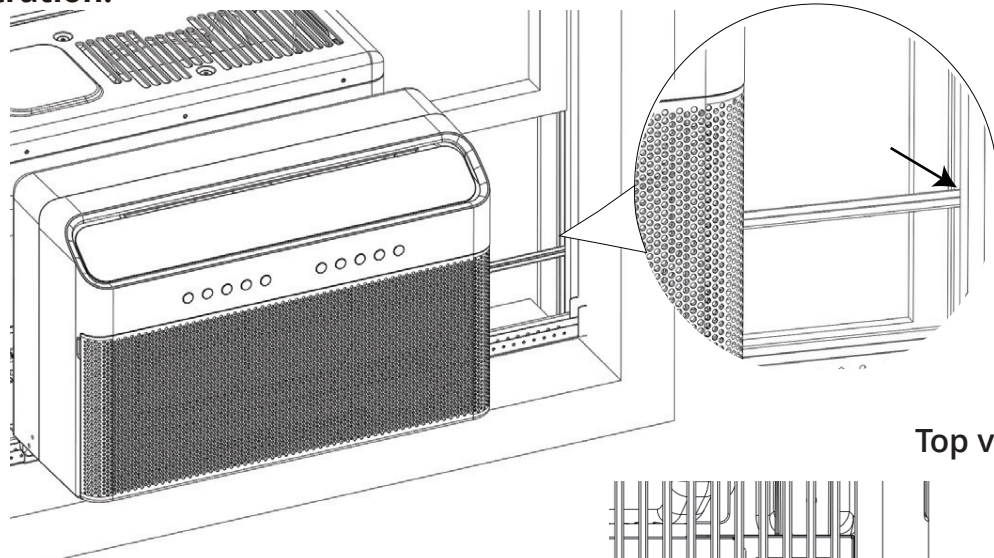

Fig. 22

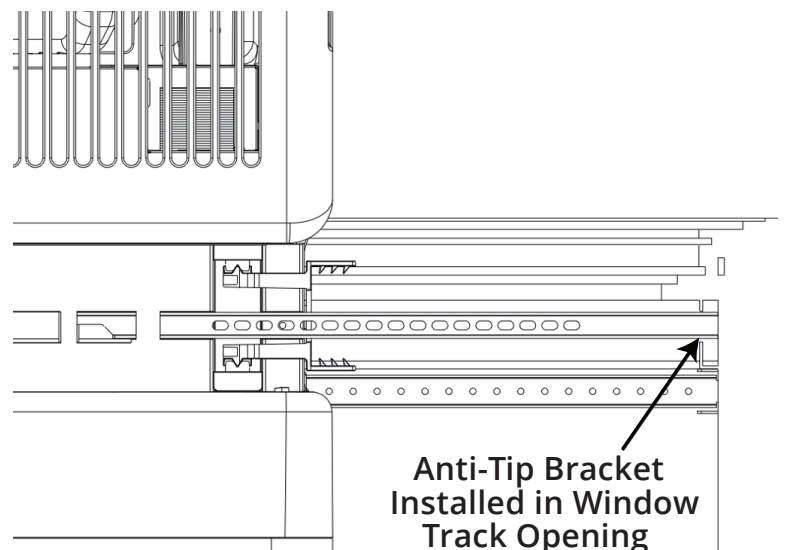

Fig. 23

Installation Instructions

E. Install a strip of **Window Sealing Foam** to the bottom of the lower portion of the window sash (bottom of the window that will lower into the slot of the air conditioner), sealing any small gaps between the window and air conditioner. Then, close the window and check for gaps. Fill any with included foam as needed.

F. Extend the **Integrated Window Locks** (located in the U channel) until they contact the window. Please refer to **Fig. 24**.

NOTE: For additional security, you can install the optional sash lock as shown in Fig. 25 and in step G below.

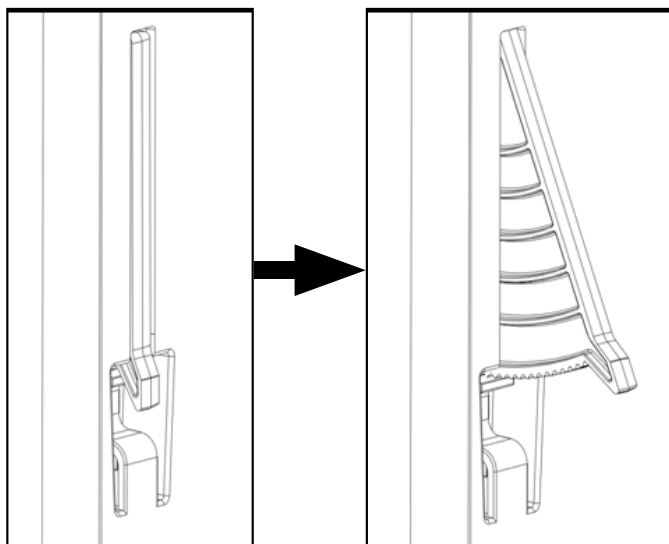

Fig. 24

G. To secure the lower sash in place, attach the **Right Angle Sash Lock** with **Type A 1/2" screws** (12.7 mm) as shown in **Fig. 25**.



Fig. 25

H. Cut the **Window Sash Foam** and insert it in the space between the upper and lower sashes, as shown in **Fig. 26**.

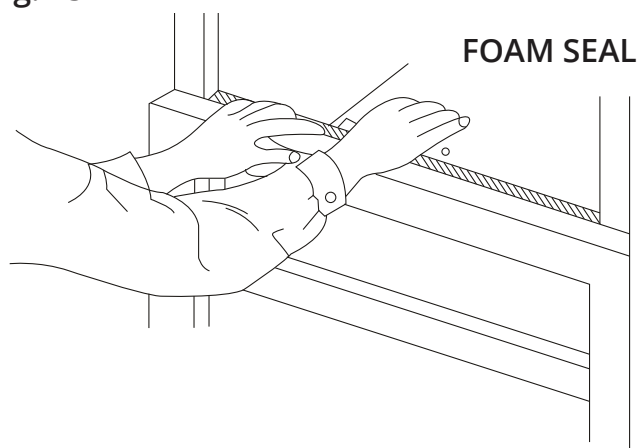

Fig. 26

Installation Instructions

I. Finally, review the installation and check for any gaps or openings to the outside air. If any are found, cover them with the provided foam ensuring no outdoor air will leak inside. Any leaks that are not sealed could affect the performance of the air conditioner. Please refer to **Fig. 27** for the areas to check for leaks/gaps.

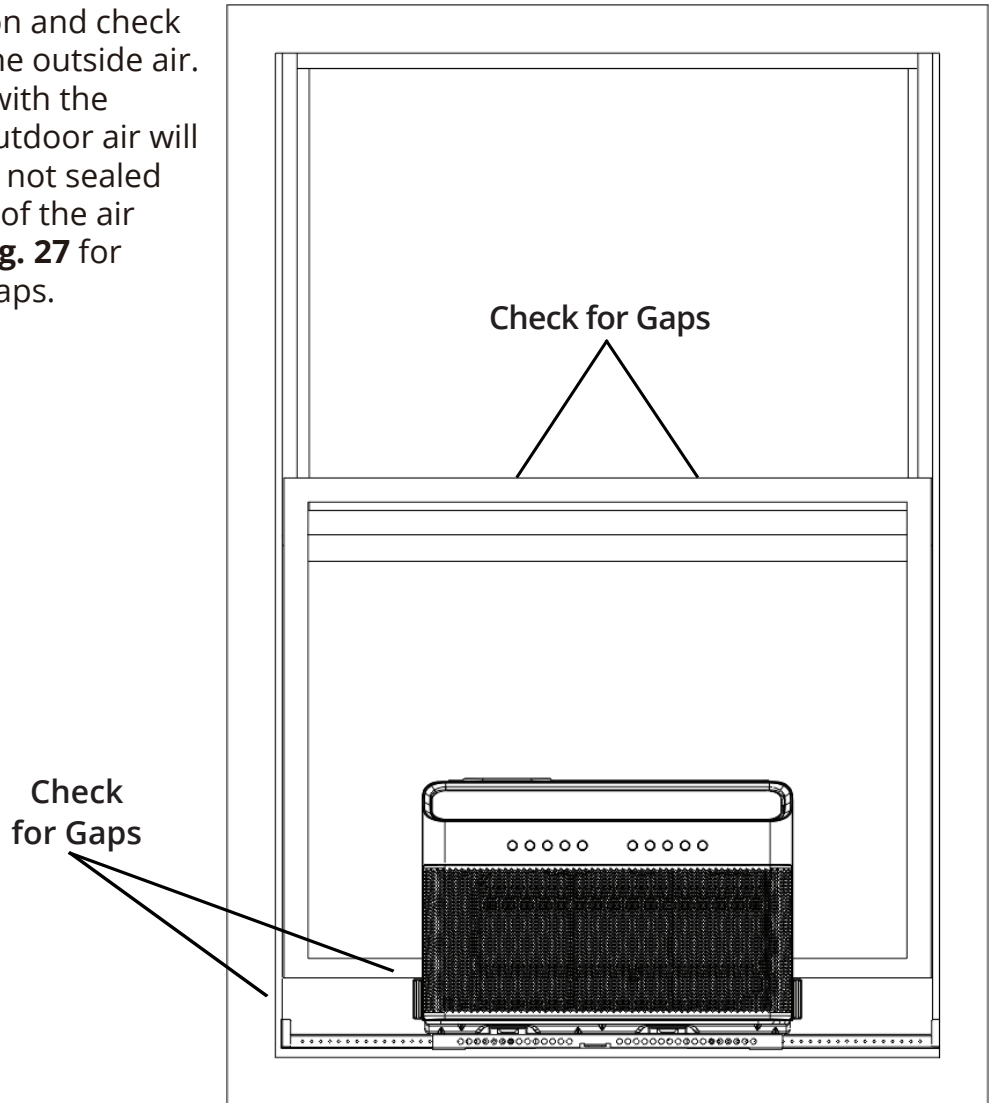

Fig. 27

IF AC IS BLOCKED BY A STORM WINDOW

Add wood as shown in the illustration, or remove storm window before the air conditioner is installed. If the storm window frame must remain, be sure the drain holes or slots are not caulked or painted over. Accumulated rain water or condensation must be allowed to drain freely.

NOTE: If wood is added, you must secure the support bracket to the wood piece using the provided Type A 1" screws (25.4 mm). Refer back to the Open Window Bracket installation step.

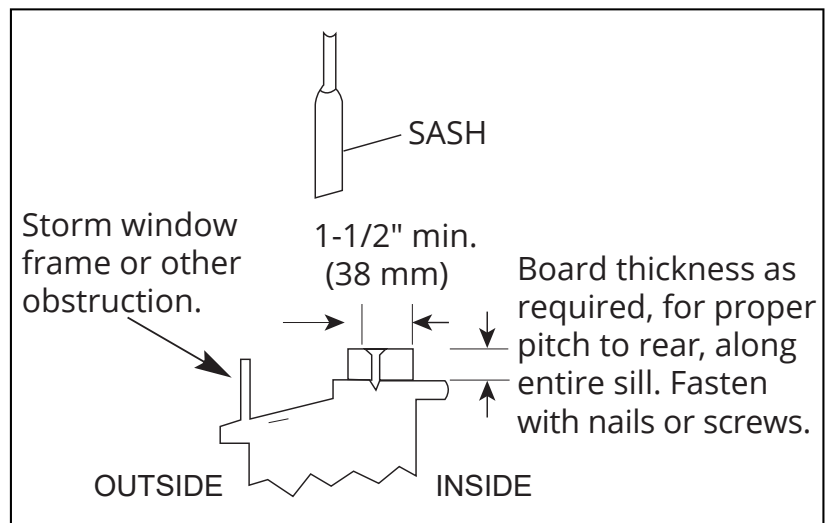

Fig. 28

The following illustration and descriptions represent noises that may be heard from the air conditioner during normal operation. These are normal and do not indicate there is a malfunction. If you should hear noises other than the ones listed, or find the unit is functioning abnormally, discontinue use, and refer to the troubleshooting section of this manual before contacting technical support.

Vibration

The unit may vibrate and make noise because of poor wall or window construction or incorrect installation.

High Pitched Chatter

High efficiency compressors could create a high pitched chatter during the cooling cycle.

Trickling Sound

Droplets of water hitting condenser during normal operation may cause a trickling sound.

Gurgle or Hissing

A "gurgling or hissing" noise may be heard due to refrigerant passing through evaporator during normal operation.

Sound of Rushing Air

The sound of rushing air being moved by the fan may be heard at the front of the unit.

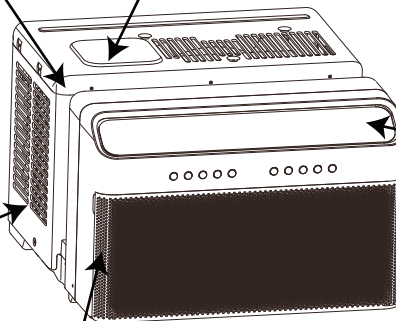

SOUND PERFORMANCE

The following table shows the sound performance data for these window unit air conditioners. Please reference your specific model number to find the rating for your unit.

Model Number	Noise Level, dB(A)*
MWUC08T115	42
MWUC10T115	42
MWUC12T115	42

*per ISO 3744 at low fan speed

NOTE:

All the illustrations in this manual are for explanation purpose only. The actual shape and size of your air conditioner may be slightly different.

⚠️ WARNING

To reduce the risk of fire, electric shock, or personal injury read the **IMPORTANT SAFETY INSTRUCTIONS** before operating this appliance.

⚠️ CAUTION

Always wait at least 3 minutes when turning the unit off then back on again. Also do this when changing from the **COOL** setting to the **FAN** setting and then back to the **COOL** setting. This will prevent the compressor from overheating and possibly tripping the circuit breaker.

Operating the Unit

To begin operating the air conditioner, follow these steps:

1. Plug in the air conditioner into the wall outlet (be sure to follow the directions for the power cord operation).
2. Turn the power on to the air conditioner, using ON/OFF button.
3. Set the thermostat to the highest number (coldest setting).
4. Select the **COOL** mode setting.
5. Adjust the louver for comfortable air flow (see Air Directional Louvers section and illustrations to the right).
6. Once the room has cooled, adjust the thermostat to the setting you find most comfortable.
7. Make sure that the airflow inside and outside are not obstructed by anything.

Air Directional Louvers

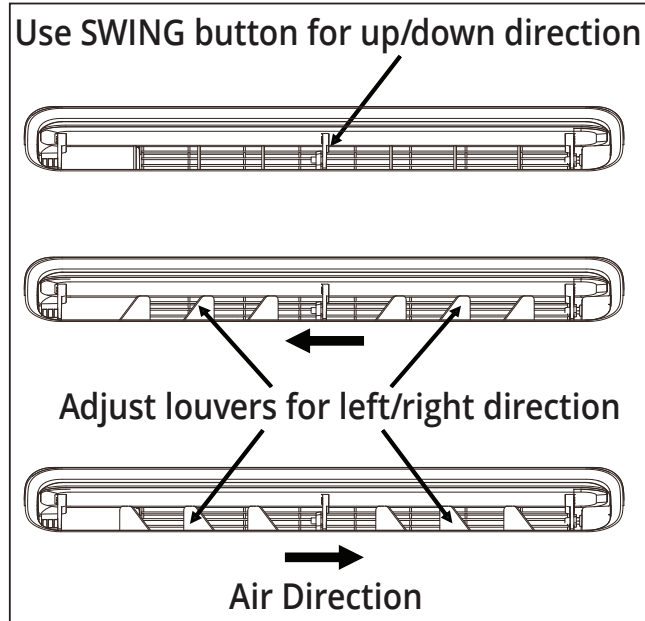

The louvers allow you to direct the airflow Up or Down (on some models) and Left or Right throughout the room as needed. Use the SWING button until the desired up/down direction is obtained. Move the Louver(s) from side to side until the desired Left or Right direction of airflow is obtained.

Operating Temperature Range

Cooling Operation	Outdoor temp:	64°F-109°F (18°C-43°C)
	Indoor temp:	60°F-90°F (16°C-32°C)

NOTE: Performance may be reduced if the unit is operated outside of these temperature ranges.

⚠️ CAUTION

The relative humidity of the room should be less than 80%. If the unit is operated in an environment with a relative humidity above 80%, there will be condensed water on surface of the unit.

Air Conditioner Operation & Features

ELECTRONIC CONTROL OPERATING INSTRUCTIONS

NOTE:

Different models have different control buttons and indicator lights. Not all of the control buttons and indicator lights described below are available on your unit. Please check the control panel of the unit you purchased.

The unit can be controlled by the controls on the unit or with the remote.

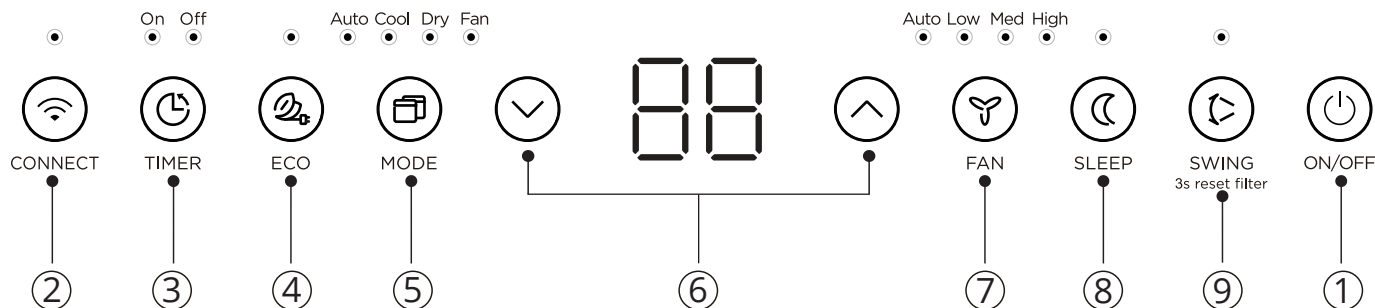

Operation & Function of buttons

- ① **ON/OFF:** Press  ON/OFF button to turn the unit on or off.

NOTE: The Energy Saver function will automatically initiate under COOL, DRY, and AUTO (only Auto-Cooling and Auto-Fan) modes.

- ② **CONNECT** button: When using Wifi function for the first time, press the button for 3 seconds to initiate the Wifi connection mode. The LED DISPLAY will show "AP", to indicate you can set the Wifi connection. If the connection (router) is successful, within 8 minutes, the unit will exit Wifi connection mode automatically and the CONNECT indicator will illuminate. If the connection fails, within 8 minutes, the unit will exit Wifi connection mode automatically. After the Wifi connection is successful, you can press and hold the CONNECT and DOWN (∨) buttons at the same time for 3 seconds to turn off Wifi function. The LED DISPLAY will show "OF" for 3 seconds, then press the CONNECT and UP (∧) buttons at the same time to turn on Wifi function. The LED DISPLAY will then show "ON" for 3 seconds.
- ③ **TIMER** button
- Press Timer button and the TIMER ON or TIMER OFF indicator light will illuminate. This indicates the Auto Start or Auto Stop program has been initiated. For some units, if you keep pressing the Timer button it will cancel the timer settings.
 - Press or hold the UP or DOWN button to change the Auto time by 0.5 hour increments, up to 10 hours, then at 1 hour increments up to 24 hours. The control will count down the time remaining until start.
 - The selected time will register for 5 seconds on the display, and then the display will automatically revert back to the previous temperature setting or room temperature if the unit is on. If the unit is off, there is no display.
 - Turning the unit ON or OFF at any time, or adjusting the timer setting to 0.0, will cancel the Auto Start/Stop timed program.

Air Conditioner Operation & Features

④ **ECO** button

Press ECO button to initiate this function. This function is available on the COOL, DRY, AUTO (only AUTO-COOLING and AUTO-FAN) modes. The fan will continue to run for 3 minutes after the compressor shuts off. The fan then cycles on for 2 minutes, at 10 minute intervals, until the room temperature is above the set temperature, at which time the compressor turns back on and cooling restarts.

⑤ **MODE** button

To select each of the operating modes, press Mode button. Each time you press the button, a mode is selected in a sequence that goes from Auto, Cool, Dry and Fan. The indicator light beside the selected mode will illuminate and remain illuminated once the mode is selected.

NOTE: The Energy Saver function will automatically initiate under COOL, DRY, and AUTO (only Auto-Cooling and Auto-Fan) modes.

1.) Operation of **AUTO** mode:

- When you set the air conditioner in **AUTO** mode, it will automatically select the cooling or fan only operation depending on the selected temperature and the room temperature.
- The air conditioner will control room temperature automatically based on the temperature you have selected.
- In this mode, the fan speed cannot be adjusted and will automatically start at a speed according to the room temperature.

2.) Operation of **COOL** mode:

- Select **COOL** Mode to set the cooling function. Then, using the Up and Down buttons to select the desired temperature. When **COOL** Mode is selected, the fan speed can be adjusted by pressing the fan button.



3.) Operation of **DRY** mode:



- In this mode, the air conditioner will operate in the form of a dehumidifier. Since the conditioned space is a closed or sealed area, some degree of cooling will continue. In **DRY** mode, the fan speed is not adjustable.

4.) To operate **FAN ONLY**:

- Use this function only when cooling is not desired, such as when the need arises for air circulation or as a means to exhaust stale air (on some models). Remember to open the vent during this function, but keep it closed during cooling for maximum cooling efficiency. Any fan speed can be selected in this mode.
- In **FAN ONLY** mode, the temperature setting cannot be adjusted.

⑥ Operation of the buttons:

Press "" or "" button to change temperature setting to desired room temperature.

NOTE: Press or hold either "" or "" button until the desired temperature is shown on the display. This temperature will be automatically maintained anywhere between 60°F (16°C) and 86°F (30°C). If you want the display to read the actual room temperature, please refer to the "To Operate Fan Only" section further in the manual.

⑦ **FAN** button

Press Fan button to select the desired fan speed. The fan speed can be adjusted in four modes; Auto, Low, Med or High. Each time the button is pressed, the fan speed mode is adjusted. On some models, the fan speed cannot be adjusted.

Air Conditioner Operation & Features

⑧ SLEEP button

Pressing the **SLEEP** button will initiate the sleep mode. In this mode, the selected temperature will increase by 2°F from the set temperature 30 minutes after the mode is selected. The temperature will then increase by another 2°F after an additional 30 minutes (total of 4°F). This new temperature will be maintained for 7 hours before it automatically returns to the originally selected temperature. This ends the **SLEEP** mode and the unit will continue to operate as originally programmed. The **SLEEP** mode program can be cancelled at any time during operation by pressing the **SLEEP** button again.

⑨ SWING button

This button is used to initiate the Auto swing feature which adjusts the airflow louvers. The function can be stopped at any time by pressing the SWING button again to stop the louver at the desired angle. Pressing the SWING button for 3 seconds will initiate the filter feature. This function is a reminder to clean the Air Filter for more efficient operation. The LED (the light above the button) will illuminate after 250 hours of operation as reminder to service or replace the filter.

DISPLAYS

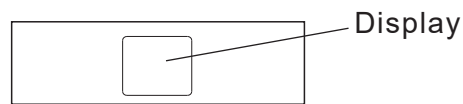

DISPLAYS:

The LED display on the unit shows the set temperature in "C°" or "F°" as well as the Auto-timer settings. While operating in **FAN ONLY** mode, the display will show the room temperature. If the room temperature is too high or low, it will display "HI" or "LO".

Error codes:

Should an error occur, the unit may stop operation or continue to run safely. If an error code should appear in the display, wait for about 10 minutes, as the problem may resolve itself. If this does not resolve the error, disconnect the power, and then reconnect it. Turn the unit on. If the problem persists, disconnect the power and contact your nearest customer service center. Error codes will appear and begin with the letters, listed below, in the window display of indoor unit:

EH(xx), EL(xx), EC(xx), PH(xx), PL(xx), PC(xx)

NOTE: If your problem persists after performing the checks and diagnostics above, turn off your unit immediately and contact an authorized service center.

NOTE:

If the unit turns off unexpectedly due to a power outage, it will restart with the last function setting/selection automatically when the power resumes.

ADDITIONAL THINGS YOU SHOULD KNOW

Now that you are familiar with the operating procedure, there are more features you should become familiar with.

- The Cool circuit has an automatic 3 minute time delay before restarting if the unit is turned off and on quickly. This prevents the compressor from overheating and possibly tripping the circuit breaker. The fan will continue to run during this time.
- The LED display is capable of displaying temperature in Fahrenheit or Celsius. To convert from one reading to the other, press and hold the Up and Down buttons together for 3 seconds.

! CAUTION

Be sure to turn off the unit and unplug it from the outlet before cleaning to prevent electric shock or fire hazards. Clean the unit occasionally to keep it looking new.

Air Filter Cleaning

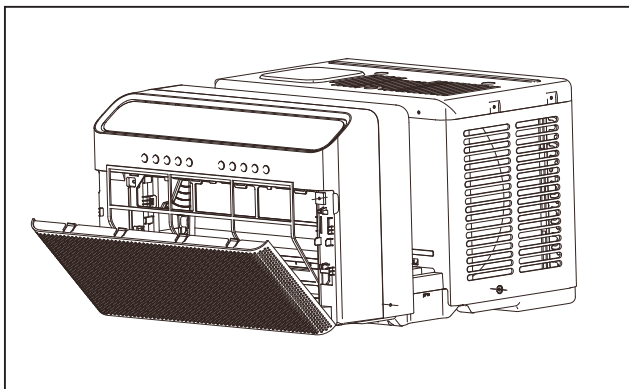

The air filter should be checked at least once a month to see if cleaning is necessary. Trapped particles in the filter can build up and cause an accumulation of frost on the cooling coils. Follow the instructions below for how to gain access to the filter and how to clean it:

- Push the vent handle to the Vent Closed position (where applicable). Then, open the front panel.
- Take the filter by the center, and pull up and out.
- Wash the filter using liquid dishwashing detergent and warm water. Then, rinse the filter thoroughly. Gently shake any excess water from the filter. Ensure the filter is thoroughly dry before replacing. Instead of washing, you could also vacuum the filter clean.

NOTE: Never use hot water, above 104°F (40°C), to clean the air filter. Never attempt to operate the unit without the air filter installed.

Cabinet Cleaning

Be sure to unplug the air conditioner before cleaning the cabinet in order to prevent electric shock or fire hazard. The cabinet and front of the unit may be dusted with an oil-free cloth, or washed with a cloth damp with a solution of warm water and mild liquid dish washing detergent. Rinse thoroughly and then wipe dry. Never use harsh cleaners, wax, or polish on the front of the cabinet. Be sure to wring excess water from the cloth before wiping around the controls. Excess water in or around the controls may cause damage to the air conditioner. Once finished, plug the air conditioner back into the outlet.

Winter Storage

If you plan to store the air conditioner during the winter, remove it carefully from the window according to the installation instructions. Cover it with plastic or return it to the original carton/box.

If your unit is not functioning or operating abnormally, please consult this list of common issues and solutions before contacting technical support. These could save you both time and money.

Problem	Solution
Air conditioner does not start	Power cord plug could be disconnected. Push plug firmly into outlet.
	A fuse could be could be blown or the circuit breaker could be tripped. Replace fuse with a time delay fuse or reset the circuit breaker.
	Plug Current Device Tripped. Press the RESET button on the head of the power plug.
	Power is OFF. Ensure the power is on
Air from unit does not feel cold	Room temperature is below operating range, 60°F (16°C). Cooling may not occur until room temperature rises above 60°F (16°C).
	Temperature sensor behind air filter contacting the cold coil. Keep it from the cold coil.
	Adjust unit to a Lower temperature.
	Compressor stops when changing modes. Wait for 3 minutes after setting to COOL mode.
	Check for potential obstructions blocking the outdoor intake/exhaust. Clear any blockage.
Air conditioner cooling, but room is too warm & ice is forming on coil behind the front cover.	Outdoor temperature is below 64°F (18°C). To defrost coil, set unit to FAN ONLY mode.
	Air filter may be dirty. Clean filter. Refer to Care and Cleaning section. To defrost, set to FAN ONLY mode.
	Thermostat set too cold for night-time cooling. To defrost the coil, set to FAN ONLY mode. Then, set temperature to a higher setting.
Air conditioner cooling, but room is too warm- NO ice is forming on coil behind front cover.	Dirty air filter is causing a restriction. Clean air filter. Refer to Care and Cleaning section.
	Temperature is set too high, set temperature to a lower setting.
	Air directional louvers positioned improperly. Position louvers for better air distribution.
	Front of unit is blocked by drapes, blinds, furniture, etc. - restricting airflow. Clear obstructions in front of unit.
	An open door, window, or register may allow cold air to escape. Close any doors, windows, or registers.
	The room may be too warm. Allow additional time to remove insulated heat stored in walls, ceiling, floor and furniture.
Air conditioner turns on and off rapidly	Dirty air filter causing airflow to be restricted. Clean air filter.
	Outside temperature is extremely hot. Set FAN speed to a higher setting so more air flows through cooling coils.
	Check for potential obstructions blocking the outdoor intake/exhaust. Clear any blockage.
Noise when unit is cooling	Air movement sound- Normal sounds of unit. If too loud, select a slower FAN setting.
	If it is a window vibration, it could be the result of a poor installation. Refer to installation instructions, or check with installer.

Troubleshooting Tips

Problem	Solution
Water dripping INSIDE when unit is cooling.	Improper installation. Tilt air conditioner slightly to the outside to allow water drainage. Refer to installation instructions - check with installer.
Water dripping OUTSIDE when unit is cooling.	Unit is removing large quantities of moisture from humid room. This is normal during excessively humid days.
Remote Sensing Deactivating Prematurely (some models)	Remote control not located within operating range. Use remote control within 20 feet and pointed in the general direction of the air conditioner unit.
	Remote control signal obstructed. Remove obstruction.
Room is too cold	Set temperature too low. Increase set temperature
Noise when unit starts	A slight thumping noise may occur within 30 seconds of the unit being turned on due to the compressor starting (For Inverter type). This is normal.



MRCOOL®

COMFORT MADE SIMPLE

**U-Shaped Window Unit
Air Conditioner
Model: MWUC**5**

The design and specifications of this product and/or manual are subject to change without prior notice.
Consult with the sales agency or manufacturer for details.