

Overview

- Relative pressure measurement from -1 to 200 bar
- Robust ceramic measuring cell
- Stainless steel housing
- Compact design
- Relative pressure and vacuum measurement



Technical data

Performance characteristics

Measuring range	-1 ... 200 bar
Min. measuring span	1.0 bar
Max. measuring span	200 bar
Pressure type	Relative (gauged)
Standard error of measurement (BFSL)	± 0.5 % FSR Including non-linearity, hysteresis and non-repeatability according BFSL
Max. measuring error	± 2.5 % FSR Including zero-point and span error, non-linearity (by terminal base line), hysteresis and non-repeatability (EN 61298-2)
Temperature coefficient	≤ 0.15 % FSR/10 K , measuring span ≤ 0.25 % FSR/10 K , zero point
Compensated temperature range	-10 ... 55 °C
Long term stability	≤ 0.3 % FSR/a
Rise time (10 ... 90 %)	≤ 3 ms

Process conditions

Process pressure	Refer to section "Operating conditions"
Process temperature	-40 ... 100 °C

Process connection

Connection variants	Refer to section "Dimensional drawings"
Wetted parts material, gasket	CR, optional NBR, optional EPDM, optional EPDM O-rings are conform to 3-A Sanitary Standard 18-03 Class II, EPDM gaskets are conform to 3-A Sanitary Standard 18-03 Class I (8% milk fat max.) FKM (Viton®), optional FKM (Viton®) gaskets require a minimum ambient temperature of -20 °C and a minimum medium temperature of -25 °C
Wetted parts material, membrane	Ceramic, 96% AL2O3
Wetted parts material, process connection	AISI 316L (1.4404)

Ambient conditions

Bump (EN 60068-2-27)	100 g / 2 ms, 4000 impulses per axis and direction
Shock (EN 60068-2-27)	50 g / 11 ms, 100 g / 6 ms, 3 impulses per axis and direction
Shock and vibration tests (EN 61373:1999, 2010)	Category 1, class B
Vibration (sinusoidal) (EN 60068-2-6)	1.5 mm p-p (10 ... 55 Hz), 10 g (55 Hz ... 2 kHz), 10 cycles (2.5 h) per axis
Vibration, broad-band random (EN 60068-2-64)	0.1 g ² / Hz, > 10 gRMS (20 Hz ... 1 kHz), 30 min. per axis
Degree of protection (EN 60529)	IP 65
Operating temperature range	-40 ... 85 °C
Storage temperature range	-40 ... 85 °C

Output signal

Current output	4 ... 20 mA , 2-wire
Voltage output	0... 10 V 0.5 ... 4.5 V DC ratiometric 1 ... 5 V
Load resistance	> 5 kΩ, with voltage output R = (U _{ver} - 11 V)/20 mA, with current output
Insulation resistance	> 100 MΩ , 250 V DC
Short circuit protection	Yes

Housing

Overall size	Refer to section "Dimensional drawings"
Style	Compact transmitter
Material	AISI 304 (1.4301)

Electrical connection

Cable outlet	1 m, 3-wire 2 m, 3-wire 5 m, 3-wire
Connector	DIN EN 175301-803 A (DIN 43650 A), 4-pin M12-A, 4-pin

Technical data

Power supply

Voltage supply range 11 ... 30 V DC , with 1 ... 5 V output signal
 11 ... 30 V DC , with 4 ... 20 mA output signal
 15 ... 30 V DC , with 0 ... 10 V output signal
 5 V DC ratiometric , with 0.5 ... 4.5 V output signal

Compliance and approvals

EMC EN 61000-6-2
 EN 61000-6-3
 EN 61326-1
 Pressure directive 97/23/EG

Operating conditions

Measuring range (bar)	Proof pressure (bar)	Burst Pressure (bar)
-1 ... 0	0 ... 1	3
-1 ... 1,5	0 ... 2,5	7
-1 ... 3	0 ... 4	12
-1 ... 5	0 ... 6	18
-1 ... 9	0 ... 10	30
-1 ... 15	0 ... 16	48
-1 ... 24	0 ... 25	75
-1 ... 39	0 ... 40	120
	0 ... 60	180
	0 ... 100	300
	0 ... 160	480
	0 ... 200	480

Dimensional drawings

Housing

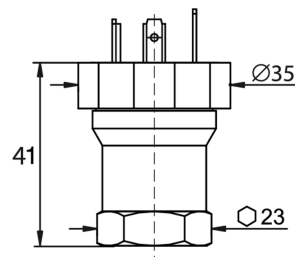
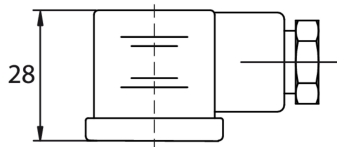

Housing with connector DIN EN 175301-803 A (DIN 43650 A), 4-pin

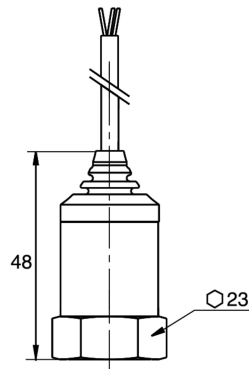

Housing with cable outlet, 3-wire

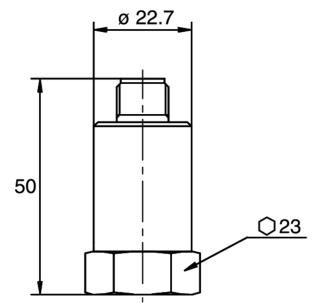

Housing with connector M12-A, 4-pin

Process connection

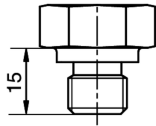

G50-B
G 1/4 A DIN 3852-E (BCID: G50)

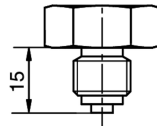

G30-2
G 1/4 B EN 837-1 (BCID: G30)

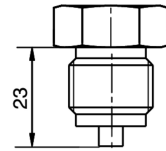

G31-3
G 1/2 B EN 837-1 (BCID: G31)

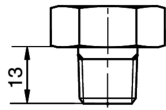

N01-5
1/4-18 NPT (BCID: N01)

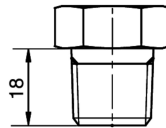

N02-6
1/2-14 NPT (BCID: N02)

Electrical connection

Output signal	Equivalent circuit	Electrical connection	Function	Pin assignment
4 ... 20 mA (2-wire)			+Vs	1
			lout	3
			Frame Ground	Plug thread, 4
0 ... 10 V (3-wire)			n.c.	2
			+Vs	1
			lout	2
			Frame Ground	Grounding lug
			n.c.	3
			+Vs	RD
			lout	BK
			n.c.	WH
0 ... 10 V (3-wire)			+Vs	1
			Uout	2
			GND (0 V)	3
			Frame Ground	Plug thread, 4
			+Vs	1
			Uout	3
			GND (0 V)	2
			Frame Ground	Grounding lug
			+Vs	RD
			Uout	WH
			GND (0 V)	BK

Ordering information

Ordering key - Configuration possibilities see website

	CTX	-	X	.	#	.	#	.	#	###	#	####
Product	CTX											
Housing material Stainless steel, 1.4404 (AISI 316L)		X										
Output signal												
4 ... 20 mA					3							
0 ... 10 V					2							
1 ... 5 V					4							
0,5 ... 4,5 V ratiometric					7							
Process connection												
G 1/4 A DIN 3852-E (G50)									B			
G 1/4 B EN 837-1 (G30)									2			
G 1/2 B EN 837-1 (G31)									3			
1/4-18 NPT (N01)									5			
1/2-14 NPT (N02)									6			
Sealing												
NBR										3		
EPDM										5		
FKM (Viton®)										9		
CR (Neoprene)										4		

Ordering key - Configuration possibilities see website

CTX - X . # . # . # ### # #####

Measuring range

0...1 bar (EN)	B15
0 ... 2.5 bar (EN)	B18
0 ... 4 bar (EN)	B19
-1...39 bar (EN)	B1L
0 ... 6 bar (EN)	B20
0 ... 10 bar (EN)	B22
0 ... 16 bar (EN)	B24
0...25 bar (EN)	B26
0...40 bar (EN)	B27
0...60 bar (EN)	B29
0...100 bar (EN)	B31
0 ... 160 bar (EN)	B33
0...200 bar (EN)	B34
-1...0 bar (EN)	B59
-1...0,6 bar (EN)	B72
-1...1,5 bar (EN)	B74
-1...3 bar (EN)	B76
-1...5 bar (EN)	B77
-1...9 bar (EN)	B79
-1...15 bar (EN)	B81
-1...24 bar (EN)	B82
0...100 kPa (EN)	D15
0...250 kPa (EN)	D18
0...400 kPa (EN)	D19
-100...3900 kPa (EN)	D1L
0...600 kPa (EN)	D20
0...1000 kPa (EN)	D22
0...1600 kPa (EN)	D24
0...2500 kPa (EN)	D26
0...4000 kPa (EN)	D27
0...6000 kPa (EN)	D29
0...10000 kPa (EN)	D31
0...16000 kPa (EN)	D33
0...20000 kPa (EN)	D34
-100...0 kPa (EN)	D59
-100...60 kPa (EN)	D72
-100...150 kPa (EN)	D74
-100...300 kPa (EN)	D76
-100...500 kPa (EN)	D77
-100...900 kPa (EN)	D79
-100...1500 kPa (EN)	D81
-100...2400 kPa (EN)	D82
0...1 kg/cm ² (EN)	F15
0...2,5 kg/cm ² (EN)	F18
0...4 kg/cm ² (EN)	F19
-1...39 kg/cm ²	F1L
0...6 kg/cm ² (EN)	F20
0...10 kg/cm ² (EN)	F22
0...16 kg/cm ² (EN)	F24

Ordering key - Configuration possibilities see website

	CTX	-	X	.	#	.	#	.	#	###	#	####
0...20 kg/cm ² (EN)											F25	
0...25 kg/cm ² (EN)											F26	
0...40 kg/cm ² (EN)											F27	
0...60 kg/cm ² (EN)											F29	
0...100 kg/cm ² (EN)											F31	
0...160 kg/cm ² (EN)											F33	
0...200 kg/cm ² (EN)											F34	
-1...0 kg/cm ² (EN)											F59	
-1...0,6 kg/cm ² (EN)											F72	
-1...1,5 kg/cm ² (EN)											F74	
-1...3 kg/cm ² (EN)											F76	
-1...5 kg/cm ² (EN)											F77	
-1...9 kg/cm ² (EN)											F79	
-1...15 kg/cm ² (EN)											F81	
-1...24 kg/cm ² (EN)											F82	
0...15 psi (ANSI)											H15	
0...30 psi (ANSI)											H17	
0...35 psi (ANSI)											H18	
0...60 psi (ANSI)											H19	
0...20 psi (ANSI)											H1C	
0...100 psi (ANSI)											H21	
0...160 psi (ANSI)											H22	
0...200 psi (ANSI)											H23	
0...250 psi (ANSI)											H24	
0...300 psi (ANSI)											H25	
0...400 psi (ANSI)											H26	
0...600 psi (ANSI)											H27	
0...1000 psi (ANSI)											H30	
0...1500 psi (ANSI)											H31	
0...2000 psi (ANSI)											H32	
Output Connection												
DIN EN 175301-803 A (DIN 43650 A), 4-pin												0
Cable outlet 1 m, 3-wire												1
Cable outlet 2 m, 3-wire												2
Cable outlet 5 m, 3-wire												5
M12-A, 4-pin												A
Signal inversion												
Signal inversion (only for 0 ... -1 bar, 0 bar = 4mA and -1 bar = 20mA)												4780
not selected												&