

SMV

Frequency Inverter



Operating instructions EN



Lenze

Copyright © 2013 - 2006 Lenze AC Tech Corporation

All rights reserved. No part of this manual may be reproduced or transmitted in any form without written permission from Lenze AC Tech Corporation. The information and technical data in this manual are subject to change without notice. Lenze AC Tech Corporation makes no warranty of any kind with respect to this material, including, but not limited to, the implied warranties of its merchantability and fitness for a given purpose. Lenze AC Tech Corporation assumes no responsibility for any errors that may appear in this manual.

All information given in this documentation has been carefully selected and tested for compliance with the hardware and software described. Nevertheless, discrepancies cannot be ruled out. We do not accept any responsibility nor liability for damages that may occur. Any necessary corrections will be implemented in subsequent editions.

This document printed in the United States

About these Instructions	2
1 Safety Information	3
2 Technical Data	7
2.1 Standards and Application Conditions	7
2.2 SMV Type Number Designation	8
2.3 Ratings	9
3 Installation	12
3.1 Dimensions and Mounting	12
3.1.1 NEMA 1 (IP31) Models ≤ 30HP (22kW)	12
3.1.2 NEMA 1 (IP31) Models > 30HP (22kW)	13
3.1.3 NEMA 4X (IP65) Models	14
3.1.4 NEMA 4X (IP65) Models with Disconnect Switch	15
3.2 Electrical Installation	16
3.2.1 Power Connections	16
3.2.1.1 Mains Connection to 120VAC Single-Phase Supply	16
3.2.1.2 Mains Connection to 240VAC Single-Phase Supply	17
3.2.1.3 Mains Connection to Three-Phase Supply	17
3.2.1.4 Motor Connection	17
3.2.1.5 Installation Recommendations for EMC Compliance	18
3.2.1.6 NEMA 4X (IP65) Input Terminal Block	18
3.2.1.7 Dynamic Brake Connections	19
3.2.2 Fuses/Cable Cross-Sections	20
3.2.3 Control Terminals	21
4 Commissioning	23
4.1 Local Keypad & Display	23
4.2 Drive Display and Modes of Operation	25
4.3 Parameter Setting	26
4.4 Electronic Programming Module (EPM)	26
4.5 Parameter Menu	27
4.5.1 Basic Setup Parameters	27
4.5.2 I/O Setup Parameters	31
4.5.3 Advanced Setup Parameters	35
4.5.4 PID Parameters	39
4.5.5 Vector Parameters	41
4.5.6 Network Parameters	43
4.5.7 Diagnostic Parameters	44
4.5.7.1 Terminal & Protection Status Display	45
4.5.7.2 Keypad Status Display	45
4.5.8 Onboard Communications Parameters 15-60HP (11-45kW)	46
4.5.9 Sequencer Parameters	47
4.5.9.1 Sequencer Flow Diagram Left	55
4.5.9.2 Sequencer Flow Diagram Right	56
4.5.9.3 Sequencer Status	57
5 Troubleshooting and Diagnostics	58
5.1 Status/Warning Messages	58
5.2 Drive Configuration Messages	59
5.3 Fault Messages	59
Appendix A	62
A.1 Permissible Cable Lengths	62



About These Instructions

This documentation applies to the SMV frequency inverter and contains important technical data regarding the installation, operation, and commissioning of the inverter.

These instructions are only valid for SMV frequency inverters with software revision 4.23 or higher for version 4.23 software, the drive nameplate illustrated below would show “42” in the “F” location.

Please read these instructions in their entirety before commissioning the drive.

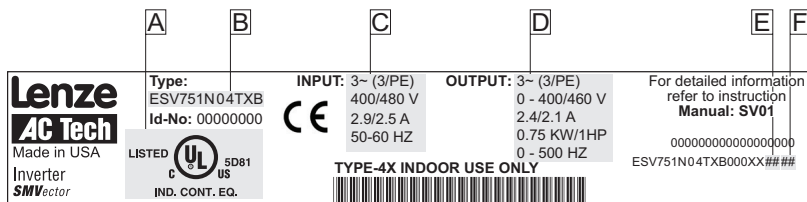

A	B	C	D	E	F
Certifications	Type	Input Ratings	Output Ratings	Hardware Version	Software Version

Scope of delivery	Important
<ul style="list-style-type: none"> • 1 SMV Inverter with EPM installed (see Section 4.4) • 1 Operating Instructions manual 	<p>After receipt of the delivery, check immediately whether the items delivered match the accompanying papers. Lenze AC Tech does not accept any liability for deficiencies claimed subsequently.</p> <p>Claim:</p> <ul style="list-style-type: none"> • visible transport damage immediately to the forwarder. • visible deficiencies /incompleteness immediately to your Lenze AC Tech representative

Related Documents

The documentation listed herein contains information relevant to the operation of the SMVector frequency inverter. To obtain the latest documentation, visit the Technical Library at <http://www.lenzeamericas.com>.

Document #	Description
CMVINS01	SMVector Communications Module Installation Instruction
CMVMB401	SMVector ModBus RTU over RS485 Communications Reference Guide
CMVLC401	SMVector Lecom Communications Reference Guide
CMVCAN01	SMVector CANopen Communications Reference Guide
CMVDVN01	SMVector DeviceNet Communications Reference Guide
CMVETH01	SMVector EtherNet/IP Communications Reference Guide
CMVFPB01	SMVector PROFIBUS Communications Reference Guide
ALSV01	SMVector Additional I/O Module Installation and Operation Manual
DBV01	SMVector Dynamic Braking
PTV01	SMVector Potentiometer Install Instructions
RKV01	SMVector ESVZXK1 Remote Keypad
RKVU01	SMVector ESVZXH0 Remote Keypad (for NEMA 1 15-60HP (11-45kW) Drives)



1 Safety Information

General

Some parts of Lenze AC Tech controllers can be electrically live and some surfaces can be hot. Non-authorized removal of the required cover, inappropriate use, and incorrect installation or operation creates the risk of severe injury to personnel and/or damage to equipment.

All operations concerning transport, installation, and commissioning as well as maintenance must be carried out by qualified, skilled personnel who are familiar with the installation, assembly, commissioning, and operation of variable frequency drives and the application for which it is being used.

Installation

Ensure proper handling and avoid excessive mechanical stress. Do not bend any components and do not change any insulation distances during transport, handling, installation or maintenance. Do not touch any electronic components or contacts. This drive contains electrostatically sensitive components, which can easily be damaged by inappropriate handling. Static control precautions must be adhered to during installation, testing, servicing and repairing of this drive and associated options. Component damage may result if proper procedures are not followed.

To ensure proper operation, do not install the drive where it is subjected to adverse environmental conditions such as combustible, oily, or hazardous vapors; corrosive chemicals; excessive dust, moisture or vibration; direct sunlight or extreme temperatures.

This drive has been tested by Underwriters Laboratory (UL) and is UL Listed in compliance with the UL508C Safety Standard. This drive must be installed and configured in accordance with both national and international standards. Local codes and regulations take precedence over recommendations provided in this and other Lenze AC Tech documentation.

The SMVector drive is considered a component for integration into a machine or process. It is neither a machine nor a device ready for use in accordance with European directives (reference machinery directive and electromagnetic compatibility directive). It is the responsibility of the end user to ensure that the machine meets the applicable standards.

Electrical Connection

When working on live drive controllers, applicable national safety regulations must be observed. The electrical installation must be carried out according to the appropriate regulations (e.g. cable cross-sections, fuses, protective earth [PE] connection). While this document does make recommendations in regards to these items, national and local codes must be adhered to.

The documentation contains information about installation in compliance with EMC (shielding, grounding, filters and cables). These notes must also be observed for CE-marked controllers. The manufacturer of the system or machine is responsible for compliance with the required limit values demanded by EMC legislation.

Application

The drive must not be used as a safety device for machines where there is a risk of personal injury or material damage. Emergency Stops, over-speed protection, acceleration and deceleration limits, etc must be made by other devices to ensure operation under all conditions.

The drive does feature many protection devices that work to protect the drive and the driven equipment by generating a fault and shutting the drive and motor down. Mains power variances can also result in shutdown of the drive. When the fault condition disappears or is cleared, the drive can be configured to automatically restart, it is the responsibility of the user, OEM and/or integrator to ensure that the drive is configured for safe operation.



Safety Information

Explosion Proof Applications

Explosion proof motors that are not rated for inverter use lose their certification when used for variable speed. Due to the many areas of liability that may be encountered when dealing with these applications, the following statement of policy applies:

Lenze AC Tech Corporation inverter products are sold with no warranty of fitness for a particular purpose or warranty of suitability for use with explosion proof motors. Lenze AC Tech Corporation accepts no responsibility for any direct, incidental or consequential loss, cost or damage that may arise through the use of AC inverter products in these applications. The purchaser expressly agrees to assume all risk of any loss, cost or damage that may arise from such application.

Operation

Systems including controllers must be equipped with additional monitoring and protection devices according to the corresponding standards (e.g. technical equipment, regulations for prevention of accidents, etc.). The controller may be adapted to your application as described in this documentation.



DANGER!

- After the controller has been disconnected from the supply voltage, live components and power connection must not be touched immediately, since capacitors could be charged. Please observe the corresponding notes on the controller.
- Close all protective covers and doors prior to and during operation.
- Do not cycle input power to the controller more than once every two minutes.
- For SMVector models that are equipped with a Disconnect Switch (11th character in model number is L or M), the Disconnect Switch is intended as a motor service disconnect and does not provide branch circuit protection to the inverter or motor. When servicing the motor, it is necessary to wait 3 minutes after turning this switch to the off position before working on motor power wiring as the inverter stores electrical power. To service the inverter, it is necessary to remove mains ahead of the drive and wait 3 minutes.

Safety Notifications

All safety information given in these Operating Instructions includes a visual icon, a bold signal word and a description.



Signal Word! (characterizes the severity of the danger)

NOTE (describes the danger and informs on how to proceed)

Icon	Signal Word	Meaning	Consequences if ignored
	DANGER!	Warns of hazardous electrical voltage.	Death or severe injuries.
	WARNING!	Warns of potential, very hazardous situations.	Risk of severe injury to personnel and/or damage to equipment.
	WARNING! Hot Surface	Warns of hot surface and risk of burns. Labels may be on or inside the equipment to alert people that surfaces may reach dangerous temperatures.	Risk of severe injury to personnel.
	STOP!	Warns of potential damage to material and equipment.	Damage to the controller/drive or its environment.
	NOTE	Designates a general, useful note.	None. If observed, then using the controller/drive system is made easier.



Harmonics Notification in accordance with EN 61000-3-2, EN 61000-3-12:

Operation in public supply networks (Limitation of harmonic currents i.a.w. EN 61000-3-2, Electromagnetic Compatibility (EMC) Limits). Limits for harmonic current emissions (equipment input current up to 16A/phase).

Directive	Total Power connected to Mains (public supply)	Additional Measures Required for Compliance ⁽²⁾
EN 61000-3-2	< 0.5kW	with mains choke
	0.5 ... 1kW	with active filter
	> 1kW	complies without additional measures
EN 61000-3-12	16 ... 75amp	Additional measures are required for compliance with the standard

- (1) For compliance with EMC regulations, the permissible cable lengths may change.
(2) The additional measures described only ensure that the controller meets the requirements of the EN 61000-3-2. The machine/system manufacturer is responsible for the machine's compliance with the regulations.

Safety Information in accordance with EN 61800-5-1:



DANGER! - Risk of Electric Shock

Capacitors retain charge for approximately 180 seconds after power is removed. Disconnect incoming power and wait at least 3 minutes before touching the drive.

DANGER! - Risque de choc électrique

Les condensateurs restent sous charge pendant environ 180 secondes après une coupure de courant. Couper l'alimentation et patienter pendant au moins 3 minutes avant de toucher l'entraînement.



WARNING!

- This product can cause a d.c. current in the PE conductor. Where a residual current-operated (RCD) or monitoring (RCM) device is used for protection in case of direct or indirect contact, only an RCD or RCM Type B is allowed on the supply side of this product.
- Leakage Current may exceed 3.5mA AC. The minimum size of the PE conductor shall comply with local safety regulations for high leakage current equipment.
- In a domestic environment, this product may cause radio interference in which case supplementary mitigation measures may be required.



Safety Information

Safety Information in accordance with UL:

Note for UL approved system with integrated controllers: UL warnings are notes which apply to UL systems. The documentation contains special information about UL.



- Integral solid state protection does not provide branch circuit protection. Branch circuit protection must be provided in accordance with the National Electrical Code and any additional local codes. The use of fuses or circuit breakers is the only approved means for branch circuit protection.
- When protected by CC and T Class Fuses, suitable for use on a circuit capable of delivering not more than 200,000 rms symmetrical amperes, at the maximum voltage rating marked on the drive.
- Additionally suitable when protected by a circuit breaker having an interrupting rating not less than 200,000 rms symmetrical amperes, at the maximum voltage rating marked on the drive. (Excludes ESV113xx2T, ESV153xx2T, ESV113xx4T, ESV153xx4T, ESV183xx4T, ESV223xx4T, ESV303xx4T, ESV113xx6T, ESV153xx6T, ESV183xx6T, ESV223xx6T, and ESV303xx6T).
- Use minimum 75°C copper wire only, except for control circuits.
- For control circuits, use wiring suitable for NEC Class 1 circuits only.
- Torque Requirements (in accordance with UL) are listed in section 3.2.1, Power Connections and in 3.2.3, Control terminals
- Shall be installed in a pollution degree 2 macro-environment.
- NEMA 1 (IP31) models shall be installed in a pollution degree 2 macro-environment.
- All models are suitable for installation in a compartment handling Conditioned Air (i.e., plenum rated).



WARNING!

The opening of branch-circuit protective device may be an indication that a fault has been interrupted. To reduce the risk of fire or electric shock, current carrying parts and other components of the controller should be examined and replaced if damaged.



AVERTISSEMENT!

Le déclenchement du dispositif de protection du circuit de dérivation peut être dû à une coupure qui résulte d'un courant de défaut. Pour limiter le risque d'incendie ou de choc électrique, examiner les pièces porteuses de courant et les autres éléments du contrôleur et les remplacer s'ils sont endommagés. En cas de grillage de l'élément traverse par le courant dans un relais de surcharge, le relais tout entier doit être remplacé.



NOTE

Control and communications terminals provide reinforced insulation (i.e. considered SELV or PELV, providing protection in case of direct contact) when the drive is connected to a power system rated up to 300VAC between phase to ground (PE) and the applied voltage on Terminals 16 and 17 is less than 150VAC between phase to ground. Otherwise, control and communications terminals provide basic insulation.



2 Technical Data

2.1 Standards and Application Conditions

Conformity	CE	Low Voltage (2006/95/EC) & EMC (2004/108/EC) Directives
Approvals	UL508C	Underwriters Laboratories -Power Conversion Equipment
Input voltage phase imbalance	≤ 2%	
Supported Power Systems	TT TN	<ul style="list-style-type: none"> – For central grounded systems, operation is permitted without restrictions. – For corner grounded 400/500V systems, operation is possible but reinforced insulation to control circuits is compromised.
Humidity	≤ 95% non-condensing	
Temperature range	Transport	-25 ... +70°C
	Storage	-20 ... +70°C
	Operation	-10 ... +55°C (with 2.5%/°C current derating above +40°C)
Installation height	0 - 4000m a.m.s.l.	(with 5%/1000 m current derating above 1000m a.m.s.l.)
Vibration resistance	acceleration resistant up to 1.0g	
⚠ Earth leakage current	> 3.5 mA to PE	
Max Permissible Cable Length ⁽¹⁾	≤ 4.0 Hp (3.0 kW)	30 meters shielded, 60 meters un-shielded
	> 5.0 Hp (3.7 kW)	50 meters shielded, 100 meters un-shielded.
Enclosure	IP31/NEMA 1	IP65/NEMA 4X
	NEMA 1 and NEMA 4X model enclosures are plenum rated in accordance with UL 508C and are suitable for installation in a compartment handling conditioned air.	
Protection measures against	Earth fault, phase loss, over voltage, under voltage, motor stalling, over temperature motor overload (125% of FLA), short circuit (SCCR=200kA at rated voltage)	
Compliance with EN 61000-3-2 Requirements ⁽²⁾	< 0.5kW	with mains choke
	0.5 ... 1kW	with active filter
	> 1kW	without additional measures
Compliance with EN 61000-3-12 Requirements ⁽²⁾	16 ... 75amp	Additional measures required for compliance with EN 61000-3-12

Operation in public supply networks (Limitation of harmonic currents i.a.w. EN 61000-3-2, Electromagnetic Compatibility (EMC) Limits). Limits for harmonic current emissions (equipment input current up to 16A/phase).

(1) The stated cable lengths are permissible at default carrier frequencies (refer to parameter P166).

(2) The additional measures described only ensure that the controller meets the requirements of the EN 61000-3-2. The machine/system manufacturer is responsible for the machine's compliance with the regulations.



Technical Data

2.2 SMV Type Number Designation

The table herein describes the Type numbering designation for the SMVector Inverter models.

Electrical Products in the SMVector Series	ESV	152	NO	2	T	X	B
Power Rating in kW:							
251 = 0.25kW (0.33HP)		113 = 11.0kW (15HP)					
371 = 0.37kW (0.5HP)		153 = 15.0kW (20HP)					
751 = 0.75kW (1HP)		183 = 18.5kW (25HP)					
112 = 1.1kW (1.5HP)		223 = 22.0kW (30HP)					
152 = 1.5kW (2HP)		303 = 30.0kW (40HP)					
222 = 2.2kW (3HP)		373 = 37.5kW (50HP)					
302 = 3.0kW (4HP)		453 = 45.0kW (60HP)					
402 = 4.0kW (5HP)							
552 = 5.5kW (7.5HP)							
752 = 7.5kW (10HP)							
Installed I/O & Communication Module(s):							
C_ = CANopen (Available all models)		The " _ " blank can be:					
D_ = DeviceNet (Available all models)		0 = Standard Keypad					
E_ = Ethernet/IP, (Available all models)							
R_ = RS-485 / ModBus /Lecom (Avail all models)							
P_ = Profibus-DP (Available all models)							
N_ = No Communications installed							
Input Voltage:							
1 = 120 VAC (doubler output) or 240 VAC							
2 = 240 VAC							
4 = 400/480 VAC							
6 = 600 VAC							
Input Phase:							
S = Single Phase Input only							
Y = Single or Three Phase Input							
T = Three Phase Input only							
Input Line Filter							
F = Integral EMC Filter							
L = Integral EMC Filter and Integrated Disconnect Switch (NEMA 4X/IP65 Models only)							
M = Integrated Disconnect Switch (NEMA 4X/IP65 Models only)							
X = No EMC Filter/ No Disconnect Switch							
Enclosure:							
B = NEMA 1/IP31; Indoor only							
C = NEMA 4X/IP65; Indoor only; Convection cooled							
D = NEMA 4X/IP65; Indoor only; Fan cooled							
E = NEMA 4X/IP65; Indoor/Outdoor; Convection cooled							
F = NEMA 4X/IP65; Indoor/Outdoor; Fan cooled							



NOTE

Prior to installation make sure the enclosure is suitable for the end-use environment

Variables that influence enclosure suitability include (but are not limited to) temperature, airborne contaminants, chemical concentration, mechanical stress and duration of exposure (sunlight, wind, precipitation).



2.3 Ratings

120V / 240VAC Models

Mains = 120V Single Phase (1/N/PE) (90...132V), 240V Single Phase (2/PE) (170...264V); 48...62Hz									
Type	Power		Mains Current		Output Current		Heat Loss (Watts)		
	Hp	kW	120V A	240V A	Cont (I _n) A	Max I %	N1/IP31	N4X/IP65 No filter	N4X/IP65 W/ filter
ESV251--1S--	0.33	0.25	6.8	3.4	1.7	200	24		
ESV371--1S--	0.5	0.37	9.2	4.6	2.4	200	32	32	
ESV751--1S--	1	0.75	16.6	8.3	4.2	200	52	41	
ESV112--1S--	1.5	1.1	20	10.0	6.0	200	74	74	

NOTES:

Output Current: The Output Current Maximum (%) is a percentage of the Output Current Continuous Amps (I_n) rating and is adjustable in parameter P171.

240VAC Models

Mains = 240V Single Phase (2/PE) (170...264V); 48...62Hz									
Type	Power		Mains Current		Output Current		Heat Loss (Watts)		
	Hp	kW	240V A		Cont (I _n) A	Max I %	N1/IP31	N4X/IP65 No filter	N4X/IP65 W/ filter
ESV251--2S--	0.33	0.25	3.4		1.7	200	20		
ESV371--2S--	0.5	0.37	5.1		2.4	200			30
ESV751--2S--	1	0.75	8.8		4.2	200			42
ESV112--2S--	1.5	1.1	12.0		6.0	200			63
ESV152--2S--	2	1.5	13.3		7.0	200			73
ESV222--2S--	3	2.2	17.1		9.6	200			97

240V Single Phase (2/PE) (170...264V), 240V Three Phase (3/PE) (170...264V); 48...62Hz									
Type	Power		Mains Current		Output Current		Heat Loss (Watts)		
	Hp	kW	1- (2/PE) A	3- (3/PE) A	Cont (I _n) A	Max I %	N1/IP31	N4X/IP65 No filter	N4X/IP65 W/ filter
ESV371--2Y--	0.5	0.37	5.1	2.9	2.4	200	27	26	
ESV751--2Y--	1	0.75	8.8	5.0	4.2	200	41	38	
ESV112--2Y--	1.5	1.1	12.0	6.9	6.0	200	64	59	
ESV152--2Y--	2	1.5	13.3	8.1	7.0	200	75	69	
ESV222--2Y--	3	2.2	17.1	10.8	9.6	200	103	93	

240V Three Phase (3/PE) (170...264V); 48...62Hz									
Type	Power		Mains Current		Output Current		Heat Loss (Watts)		
	Hp	kW	240V A		Cont (I _n) A	Max I %	N1/IP31	N4X/IP65 No filter	N4X/IP65 W/ filter



Technical Data

ESV112--2T--	1.5	1.1	6.9	6	200	64		
ESV152--2T--	2	1.5	8.1	7	200	75		
ESV222--2T--	3	2.2	10.8	9.6	200	103		
ESV402--2T--	5	4.0	18.6	16.5	200	154	139	
ESV552--2T--	7.5	5.5	26	23	200	225	167	
ESV752--2T--	10	7.5	33	29	200	274	242	
ESV113--2T--	15	11	48	42	180	485	468	
ESV153--2T--	20	15	59	54	180	614	591	

NOTES:

Output Current: The Output Current Maximum (%) is a percentage of the Output Current Continuous Amps (In) rating and is adjustable in parameter P171.

400...480VAC Models

400 ... 480V Three Phase (3/PE) (400V: 340...440V), (480V: 340...528V); 48...62Hz											
Type	Power		Mains Current		Output Current				Heat Loss (Watts)		
	Hp	kW	400V A	480V A	Cont (I _n) A		Max I %		N1/IP31	N4X/IP65 No filter	N4X/IP65 W/ filter
					400V	480V	400V	480V			
ESV371--4T--	0.5	0.37	1.7	1.5	1.3	1.1	175	200	23	21	25
ESV751--4T--	1	0.75	2.9	2.5	2.4	2.1	175	200	37	33	37
ESV112--4T--	1.5	1.1	4.2	3.6	3.5	3.0	175	200	48	42	46
ESV152--4T--	2	1.5	4.7	4.1	4.0	3.5	175	200	57	50	54
ESV222--4T--	3	2.2	6.1	5.4	5.5	4.8	175	200	87	78	82
ESV302--4T--	4	3.0	8.3	7.0	7.6	6.3	175	200			95
ESV402--4T--	5	4.0	10.6	9.3	9.4	8.2	175	200	128	103	111
ESV552--4T--	7.5	5.5	14.2	12.4	12.6	11.0	175	200	178	157	165
ESV752--4T--	10	7.5	18.1	15.8	16.1	14.0	175	200	208	190	198
ESV113--4T--	15	11	27	24	24	21	155	180	418	388	398
ESV153--4T--	20	15	35	31	31	27	155	180	493	449	459
ESV183--4T--	25	18.5	44	38	39	34	155	180	645	589	600
ESV223--4T--	30	22	52	45	46	40	155	180	709	637	647
ESV303--4T--	40	30	68	59	60	52	155	180	1020		
ESV373--4T--	50	37.5	85	74	75	65	155	180	1275		
ESV453--4T--	60	45	100	87	88	77	155	180	1530		

NOTES:

Output Current: The Output Current Maximum (%) is a percentage of the Output Current Continuous Amps (In) rating and is adjustable in parameter P171.

For 400...480 VAC models, the output current maximum (%) in the 400V column is used when P107 = 0

For 400...480 VAC models, the output current maximum (%) in the 480V column is used when P107 = 1



600VAC Models

600V Three Phase (3/PE) (425...660V); 48...62Hz								
Type	Power		Mains Current	Output Current		Heat Loss (Watts)		
	Hp	kW	A	Cont (I _n) A	Max I %	N1/IP31	N4X/IP65 No filter	N4X/IP65 W/ filter
ESV751--6T--	1	0.75	2	1.7	200	37	31	
ESV152--6T--	2	1.5	3.2	2.7	200	51	43	
ESV222--6T--	3	2.2	4.4	3.9	200	68	57	
ESV402--6T--	5	4	6.8	6.1	200	101	67	
ESV552--6T--	7.5	5.5	10.2	9	200	148	116	
ESV752--6T--	10	7.5	12.4	11	200	172	152	
ESV113--6T--	15	11	19.7	17	180	380	356	
ESV153--6T--	20	15	25	22	180	463	431	
ESV183--6T--	25	18.5	31	27	180	560	519	
ESV223--6T--	30	22	36	32	180	640	592	
ESV303--6T--	40	30	47	41	180	930		
ESV373--6T--	50	37.5	59	52	180	1163		
ESV453--6T--	60	45	71	62	180	1395		

NOTES:

Output Current: The Output Current Maximum (%) is a percentage of the Output Current Continuous Amps (In) rating and is adjustable in parameter P171.



STOP!

- For installations above 1000m a.m.s.l., derate I_n by 5% per 1000m, do not exceed 4000m a.m.s.l.
- Operation above 40°C, derate I_n by 2.5% per °C, do not exceed 55°C.

Output Current (In) derating for Carrier Frequency (P166) for NEMA 1 (IP31) Models:

- If P166=2 (8 kHz), derate I_n to 92% of drive rating
- If P166=3 (10 kHz), derate I_n to 84% of drive rating

Output Current (In) derating for Carrier Frequency (P166) for NEMA 4X (IP65) Models:

- If P166=1 (6 kHz), derate I_n to 92% of drive rating
- If P166=2 (8 kHz), derate I_n to 84% of drive rating
- If P166=3 (10 kHz), derate I_n to 76% of drive rating



Installation

3 Installation

3.1 Dimensions and Mounting



WARNING!

Drives must not be installed where subjected to adverse environmental conditions such as: combustible, oily, or hazardous vapors; corrosive chemicals; excessive dust, moisture or vibration; direct sunlight or extreme temperatures.

3.1.1 NEMA 1 (IP31) Models ≤ 30HP (22kW)

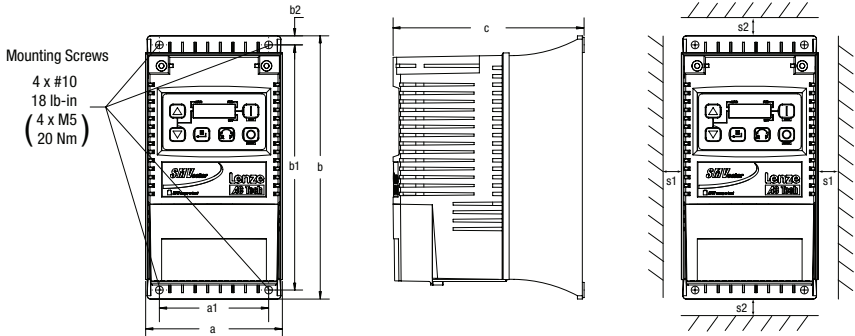

	Type	a in (mm)	a1 in (mm)	b in (mm)	b1 in (mm)	b2 in (mm)	c in (mm)	s1 in (mm)	s2 in (mm)	m lb (kg)
G1	ESV251----B; ESV371 ESV751----B	3.90 (99)	3.12 (79)	7.48 (190)	7.00 (178)	0.24 (6)	4.35 (111)	0.6 (15)	2.0 (50)	2.0 (0.9)
G2	ESV112----B; ESV152 ESV222----B	3.90 (99)	3.12 (79)	7.52 (191)	7.00 (178)	0.26 (7)	5.45 (138)	0.6 (15)	2.0 (50)	2.8 (1.3)
G3	ESV402----B	3.90 (99)	3.12 (79)	7.52 (191)	7.00 (178)	0.30 (8)	5.80 (147)	0.6 (15)	2.0 (50)	3.2 (1.5)
H1	ESV552----B; ESV752----B	5.12 (130)	4.25 (108)	9.83 (250)	9.30 (236)	0.26 (7)	6.30 (160)	0.6 (15)	2.0 (50)	6.0 (2.0)
J1	ESV113----B; ESV153----B ESV183----B; ESV223----B	6.92 (176)	5.75 (146)	12.50 (318)	11.88 (302)	0.31 (8)	8.09 (205)	0.6 (15)	2.0 (50)	13.55 (6.15)

Conduit Hole Dimensions		Type	N in (mm)	P in (mm)	P1 in (mm)	Q in (mm)	S in (mm)
	G1	1.84 (47)	1.93 (49)	.70 (18)	1.00 (25)	.88 (22)	
	G2	1.84 (47)	3.03 (77)	.70 (18)	1.00 (25)	.88 (22)	
	G3	1.84 (47)	3.38 (86)	.70 (18)	1.00 (25)	.88 (22)	
	H1	2.46 (62)	3.55 (90)	.13 (3)	1.38 (35)	1.13 (29) .88 (22)	
	J1	3.32 (84)	4.62 (117)	.73 (19)	1.40 (36)	1.31 (33)	
						.88 (22)	



3.1.2 NEMA 1 (IP31) Models > 30HP (22kW)

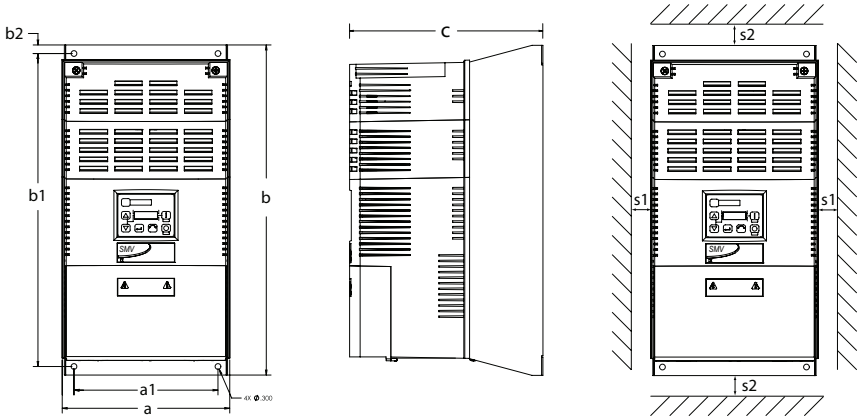

	Type	a in (mm)	a1 in (mm)	b in (mm)	b1 in (mm)	b2 in (mm)	c in (mm)	s1 in (mm)	s2 in (mm)	m lb (kg)
K1	ESV303--4--B; ESV303--6--B	8.72 (221)	7.50 (190)	14.19 (360)	13.30 (338)	0.45 (11.4)	10.07 (256)	0.6 (15)	2.0 (50)	24 (10.9)
K2	ESV373--4--B; ESV373--6--B	8.72 (221)	7.50 (190)	17.19 (436)	16.30 (414)	0.45 (11.4)	10.07 (256)	0.6 (15)	2.0 (50)	31 (14.1)
K3	ESV453--4--B ESV453--6--b	8.72 (221)	7.50 (190)	20.19 (513)	19.30 (490)	0.45 (11.4)	10.07 (256)	0.6 (15)	2.0 (50)	35 (15.9)

	Conduit Hole Dimensions		Type	N in (mm)	P in (mm)	P1 in (mm)	Q in (mm)	S in (mm)	S1 in (mm)
				K1	3.75 (95)	5.42 (137)	1.50 (38.1)	1.75 (44.4)	1.75 (44.4)
			K2	3.75 (95)	5.42 (137)	1.50 (38.1)	1.75 (44.4)	1.75 (44.4)	0.875 (22.2)
			K3	3.75 (95)	5.42 (137)	1.50 (38.1)	1.75 (44.4)	1.75 (44.4)	0.875 (22.2)



Installation

3.1.3 NEMA 4X (IP65) Models

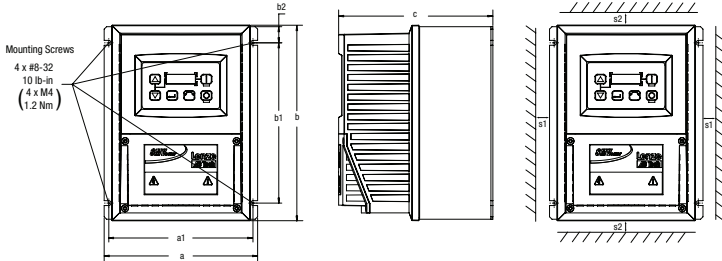

	Type	a in (mm)	a1 in (mm)	b in (mm)	b1 in (mm)	b2 in (mm)	c in (mm)	s1 in (mm)	s2 in (mm)	m lb (kg)
R1	ESV371N01SX_ ; ESV751N01SX_ ; ESV371N02YX_ ; ESV751N02YX_ ; ESV371N04TX_ ; ESV751N04TX_ ; ESV751N06TX_ ; ESV371N02SF_ ; ESV751N02SF_ ; ESV371N04TF_ ; ESV751N04TF_ ;	6.28 (160)	5.90 (150)	8.00 (203)	6.56 (167)	0.66 (17)	4.47 (114)	2.00 (51)	2.00 (51)	3.6 (1.63)
R2	ESV112N01SX_ ; ESV112N02YX_ ; ESV152N02YX_ ; ESV112N04TX_ ; ESV152N04TX_ ; ESV222N04TX_ ; ESV152N06TX_ ; ESV222N06TX_ ; ESV112N02SF_ ; ESV152N02SF_ ; ESV112N04TF_ ; ESV152N04TF_ ; ESV222N04TF_ ; ESV302N04TF_ ;	6.28 (160)	5.90 (150)	8.00 (203)	6.56 (167)	0.66 (17)	6.31 (160)	2.00 (51)	2.00 (51)	5.9 (2.68)
S1	ESV222N02YX_ ; ESV222N02SF_	7.12 (181)	6.74 (171)	8.00 (203)	6.56 (167)	0.66 (17)	6.77 (172)	2.00 (51)	2.00 (51)	7.1 (3.24)
T1	ESV552N02TX_ ; ESV752N02TX_ ; ESV752N04TX_ ; ESV752N06TX_ ; ESV752N04TF_ ;	8.04 (204)	7.56 (192)	10.00 (254)	8.04 (204)	0.92 (23)	8.00 (203)	4.00 (102)	4.00 (102)	10.98 (4.98)
V1	ESV402N02TX_ ; ESV402N04TX_ ; ESV552N04TX_ ; ESV402N06TX_ ; ESV552N06TX_ ; ESV402N04TF_ ; ESV552N04TF_ ;	8.96 (228)	8.48 (215)	10.00 (254)	8.04 (204)	0.92 (23)	8.00 (203)	4.00 (102)	4.00 (102)	11.58 (5.25)
W1	ESV113N02TX_ ; ESV153N02TX_ ; ESV113N04TX_ ; ESV153N04TX_ ; ESV113N04TF_ ; ESV153N04TF_ ; ESV113N06TX_ ; ESV153N06TX_ ; ESV183N04TX_ ; ESV183N04TF_ ; ESV183N06TX_ ;	9.42 (240)	8.94 (228)	14.50 (368)	12.54 (319)	0.92 (24)	9.45 (241)	4.00 (102)	4.00 (102)	22.0 (10.0)
X1	ESV223N04TX_ ; ESV223N04TF_ ; ESV223N06TX_ ;	9.42 (240)	8.94 (228)	18.5 (470)	16.54 (420)	0.92 (24)	9.45 (241)	4.00 (102)	4.00 (102)	25.5 (11.6)

_ = Last digit of part number:

C = N4X Indoor (convection cooled)

E = N4X In/Outdoor (convection cooled)

~ = Last digit of part number: D = N4X Indoor (fan cooled)

F = N4X In/Outdoor (fan cooled)

Conduit Hole Dimensions		Type	N in (mm)	P in (mm)	Q in (mm)	S in (mm)	S1 in (mm)
		R1	3.14 (80)	2.33 (59)	1.50 (38)	.88 (22)	n/a
		R2	3.14 (80)	4.18 (106)	1.50 (38)	.88 (22)	n/a
		S1	3.56 (90)	4.63 (118)	1.50 (38)	.88 (22)	n/a
		T1	4.02 (102)	5.00 (127)	1.85 (47)	1.06 (27)	n/a
		V1	4.48 (114)	5.00 (127)	1.85 (47)	1.06 (27)	n/a
		W1	4.71 (120)	5.70 (145)	2.00 (51)	1.375 (35)	1.125 (28)
		X1	4.71 (120)	5.70 (145)	2.00 (51)	1.375 (35)	1.125 (28)



3.1.4 NEMA 4X (IP65) Models with Disconnect Switch

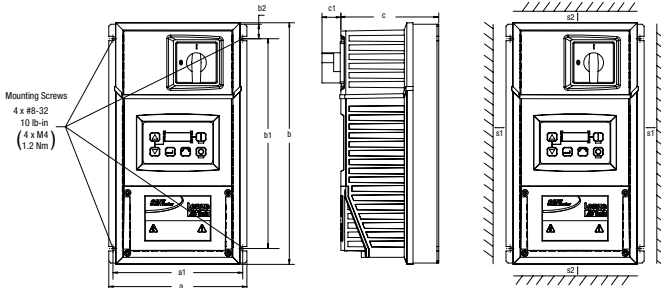

Type	a in (mm)	a1 in (mm)	b in (mm)	b1 in (mm)	b2 in (mm)	c in (mm)	c1 in (mm)	s1 in (mm)	s2 in (mm)	m lb (kg)	
AA1	ESV371N01SM_ ; ESV371N02YM_ ; ESV371N02SL_ ; ESV371N04TM_ ; ESV371N04TL_ ; ESV371N06TM_ ; ESV751N01SM_ ; ESV751N02YM_ ; ESV751N02SL_ ; ESV751N04TM_ ; ESV751N04TL_ ; ESV751N06TM_ ;	6.28 (160)	5.90 (150)	10.99 (279)	9.54 (242)	0.66 (17)	4.47 (114)	.86 (22)	2.00 (51)	2.00 (51)	4.7 (2.13)
AA2	ESV112N01SM_ ; ESV112N02YM_ ; ESV112N02SL_ ; ESV112N04TM_ ; ESV112N04TL_ ; ESV152N02YM_ ; ESV152N02SL_ ; ESV152N04TM_ ; ESV152N04TL_ ; ESV152N06TM_ ; ESV222N04TM_ ; ESV222N04TL_ ; ESV222N06TM_ ; ESV302N04TL_ ;	6.28 (160)	5.90 (150)	10.99 (279)	9.54 (242)	0.66 (17)	6.31 (160)	.86 (22)	2.00 (51)	2.00 (51)	7.9 (3.58)
AD1	ESV222N02SL_ ; ESV222N02YM_ ;	7.12 (181)	6.74 (171)	10.99 (279)	9.54 (242)	0.66 (17)	6.77 (172)	.86 (22)	2.00 (51)	2.00 (51)	9.0 (4.08)
AB1	ESV552N02TM_ ; ESV752N02TM_ ; ESV752N04TM_ ; ESV752N06TM_ ; ESV752N04TL_ ;	8.04 (204)	7.56 (192)	13.00 (330)	11.04 (280)	0.92 (23)	8.00 (203)	.86 (22)	4.00 (102)	4.00 (102)	13.9 (6.32)
AC1	ESV402N02TM_ ; ESV402N04TM_ ; ESV552N04TM_ ; ESV402N06TM_ ; ESV552N06TM_ ; ESV402N04TL_ ; ESV552N04TL_ ;	8.96 (228)	8.48 (215)	13.00 (330)	11.04 (280)	0.92 (23)	8.04 (204)	.86 (22)	4.00 (102)	4.00 (102)	14.7 (6.66)
AE1	ESV113N04TM_ ; ESV153N04TM_ ; ESV113N06TM_ ; ESV153N06TM_ ;	9.42 (240)	8.94 (228)	14.50 (368)	12.54 (319)	0.92 (24)	9.45 (241)	0.73 (19)	4.00 (102)	4.00 (102)	23.0 (10.4)
AF1	ESV113N02TM_ ; ESV153N02TM_ ; ESV113N04TL_ ; ESV153N04TL_ ; ESV183N04TL_ ; ESV223N04TL_ ; ESV183N04TM_ ; ESV223N04TM_ ; ESV183N06TM_ ; ESV223N06TM_ ;	9.42 (240)	8.94 (228)	18.5 (470)	16.54 (420)	0.92 (24)	9.45 (241)	0.73 (19)	4.00 (102)	4.00 (102)	28.5 (12.9)

_ = Last digit of part number: C = N4X Indoor (convection cooled)

~ = Last digit of part number: D = N4X Indoor (fan cooled)

Conduit Hole Dimensions		Type	N in (mm)	P in (mm)	Q in (mm)	S in (mm)	S1 in (mm)
		AA1	3.14 (80)	2.33 (59)	1.50 (38)	.88 (22)	n/a
		AA2	3.14 (80)	4.18 (106)	1.50 (38)	.88 (22)	n/a
		AD1	3.56 (90)	4.63 (118)	1.50 (38)	.88 (22)	n/a
		AB1	4.02 (102)	5.00 (127)	1.85 (47)	1.06 (27)	n/a
		AC1	4.48 (114)	5.00 (127)	1.85 (47)	1.06 (27)	n/a
		AE1	4.71 (120)	5.70 (145)	2.00 (51)	1.375 (35)	1.125 (28)
		AF1	4.71 (120)	5.70 (145)	2.00 (51)	1.375 (35)	1.125 (28)



Installation

3.2 Electrical Installation

Installation After a Long Period of Storage



STOP!

Severe damage to the drive can result if it is operated after a long period of storage or inactivity without reforming the DC bus capacitors.

If input power has not been applied to the drive for a period of time exceeding three years (due to storage, etc), the electrolytic DC bus capacitors within the drive can change internally, resulting in excessive leakage current. This can result in premature failure of the capacitors if the drive is operated after such a long period of inactivity or storage.

In order to reform the capacitors and prepare the drive for operation after a long period of inactivity, apply input power to the drive for 8 hours prior to actually operating the motor.

3.2.1 Power Connections



STOP!

If the kVA rating of the AC supply transformer is greater than 10 times the input kVA rating of the drive(s), an isolation transformer or 2-3% input line reactor must be added to the line side of the drive(s).



DANGER! Hazard of electrical shock!

Circuit potentials up to 600 VAC are possible. Capacitors retain charge after power is removed. Disconnect power and wait at least three minutes before servicing the drive.



STOP!

- Verify mains voltage before connecting to drive.
- Do not connect mains power to the output terminals (U,V,W)! Severe damage to the drive will result.
- Do not cycle mains power more than once every two minutes. Damage to the drive may result.

Mains and Motor Terminations			
Type	Torque	Strip Length	
<5HP	12 lb-in (1.3 Nm)	5/16 in (8mm)	
ESV552xx2T, ESV752xx2T, ESV113xx4/6, ESV153xx4/6, ESV183xx6, ESV223xx6	16 lb-in (1.8 Nm)	5/16 in (8mm)	
ESV552xx4Txx, ESV752xx4Txx, ESV552xx6Txx, ESV752xx6Txx	12 lb-in (1.3Nm)	0.25 in (6mm)	
ESV113xx2xxx, ESV153xx2xxx, ESV183xx4xxx, ESV223xx4xxx, ESV303xx4xxx	24 lb-in (2.7 Nm)	7/16 in (10mm)	
ESV373xx4xxx, ESV453xx4xxx	27 lb-in (3.05 Nm)	0.75 in (19mm)	
Torque: N4X/IP65 Door Screws			
N4X/IP65	6-7 lb-in (0.67-0.79 Nm)	0.25 in (6mm)	

3.2.1.1 Mains Connection to 120VAC Single-Phase Supply

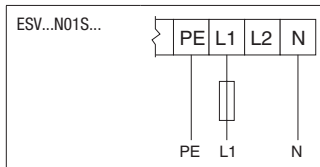



3.2.1.2 Mains Connection to 240VAC Single-Phase Supply

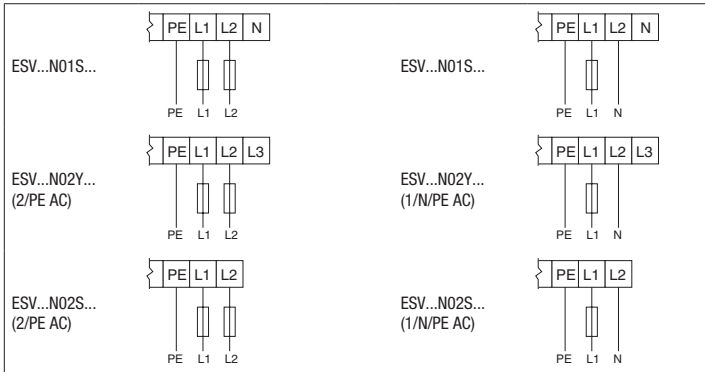

3.2.1.3 Mains Connection to Three-Phase Supply

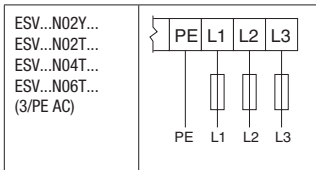

3.2.1.4 Motor Connection

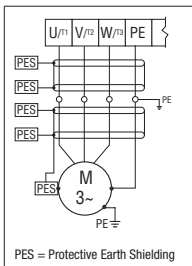

WARNING!

If the cable connection between the drive and the motor has an in-line contactor or circuit breaker then the drive must be stopped prior to opening/closing the contacts. Failure to do so may result in overcurrent trips and/or damage to the inverter.



WARNING!

Leakage current may exceed 3.5 mA AC. The minimum size of the protective earth (PE) conductor shall comply with local safety regulations for high leakage current equipment.



STOP!

In the case of a Spinning Motor:

To bring free-wheeling loads such as fans to a rest before starting the drive, use the DC injection braking function. Starting a drive into a freewheeling motor creates a direct short-circuit and may result in damage to the drive.

Confirm motor suitability for use with DC injection braking.

Consult parameter P110 for starting / restarting into spinning motors.



Installation

3.2.1.5 Installation Recommendations for EMC Compliance

For compliance with EN 61800-3 or other EMC standards, motor cables, line cables and control or communications cables must be shielded with each shield/screen clamped to the drive chassis. This clamp is typically located at the conduit mounting plate.

The EMC requirements apply to the final installation in its entirety, not to the individual components used. Because every installation is different, the recommended installation should follow these guidelines as a minimum. Additional equipment (such as ferrite core absorbers on power conductors) or alternative practices may be required to meet conformance in some installations.

Motor cable should be low capacitance (core/core <75pF/m, core/shield <150pF/m). Filtered drives can meet the class A limits of EN 55011 and EN 61800-3 Category 2 with this type of motor cable up to 10 meters.

NOTE: Refer to Appendix A for recommended cable lengths. Any external line filter should have its chassis connected to the drive chassis by mounting hardware or with the shortest possible wire or braid.

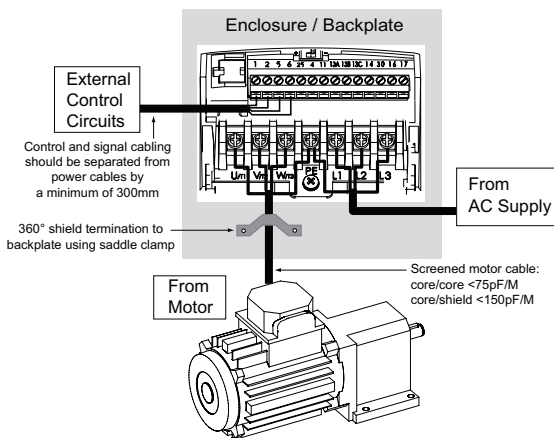

3.2.1.6 NEMA 4X (IP65) Input Terminal Block

For NEMA 4X (IP65) models with integrated EMC filter and/or integrated line disconnect, the input terminal block is located on the right-hand side of the SMV inverter in the NEMA 4 X (IP65) enclosure. The single and three phase models are illustrated herein. Refer to paragraph 3.2.3 Control Terminals for pin out information.

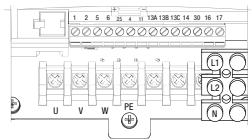

Single Phase (2/PE) 120/240 VAC models (ESVxxN01SMC) with integrated line disconnect

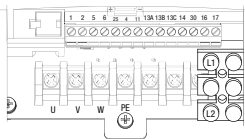

Single Phase (2/PE) 240 VAC models with Filter and/or integrated line disconnect

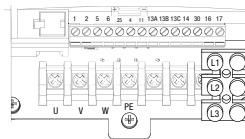

Three Phase (3/PE) models with Filter and/or integrated line disconnect



WARNING

Power remains present for up to 3 minutes on power input terminals (L1, L2 and L3) and output terminals (U, V and W) even when the disconnect switch is in the OFF position. Remove input power ahead of the drive and wait 3 minutes before removing the terminal cover.



3.2.1.7 Dynamic Brake Connections

For NEMA 1 and NEMA 4X Drives rated up to 30HP (22kW) the Dynamic Brake connections are made as illustrated herein. Refer to the SMV Dynamic Brake Instructions (DBV01) for complete information.

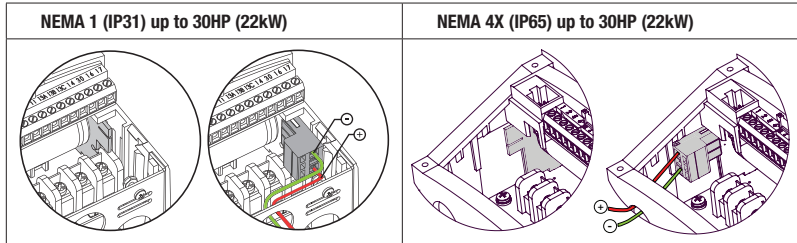

The SMV 40...60Hp (30...45kW) models include a dynamic brake transistor as standard and only require the connection of an external resistor kit for dynamic braking operation. The dynamic brake resistor connections for 40...60 Hp (30...45kW) drives are standard built-in connections as illustrated in the diagram below. In the 40Hp (30kW) model drives, the dynamic brake connector is on the right-hand side of the drive and the terminals from top to bottom are B-, BRAKE and B+. In the 50/60HP (37.5/45 kW) model drives, the dynamic brake connector is on the left-hand side of the drive and the terminals from top to bottom are B+, BRAKE and B-.

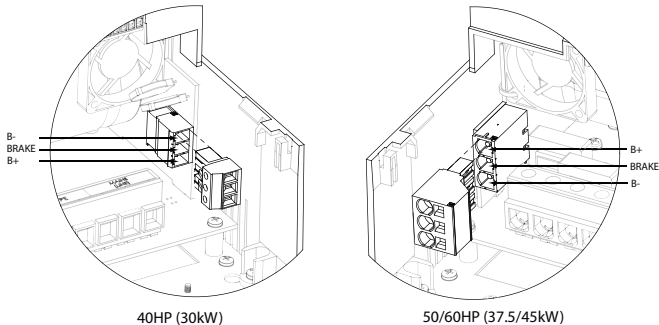

External resistor kits must be connected to terminals B+ and BRAKE (no connection to B-). Refer to the table herein for external resistor kit selection. Refer to parameter P189 for enabling the dynamic brake function in the 40...60Hp (30...45kW) models.

400/480 VAC SMV Inverter			Resistor Kit			
Type	Hp	kW	Resistance (Ω)	Power (W)	Catalog #	SAP#
ESV303**4T**	40	30	23.5	1020	841-013	13317724
ESV373**4T**	50	37	17	1400	841-015	13317626
ESV453**4T**	60	45	17	1400	841-015	13317626
600 VAC SMV Inverter			Resistor Kit			
Type	Hp	kW	Resistance (Ω)	Power (W)	Catalog #	SAP#
ESV303**6T**	40	30	35	1070	841-014	13317624
ESV373**6T**	50	37	24	1560	841-016	13317628
ESV453**6T**	60	45	24	1560	841-016	13317628



Installation

3.2.2 Fuses/Cable Cross-Sections



NOTE: Observe local regulations. Local codes may supersede these recommendations

WARNING: Use a FUSE * for 240V drives requiring > 40A protection and for 400/480/600V drives requiring >32A protection.

Type		Recommendations				
		Fuse	Miniature circuit breaker ⁽¹⁾	Fuse ⁽²⁾ or Breaker ⁽³⁾ (N. America)	Input Power Wiring (L1, L2, L3, PE)	
					[mm ²]	[AWG]
120V 1~ (1/N/PE)	ESV251N01SXB	M10 A	C10 A	10 A	1.5	14
	ESV371N01SXB, ESV371N01SX*	M16 A	C16 A	15 A	2.5	14
	ESV751N01SXB, ESV751N01SX*	M25 A	C25 A	25 A	4	10
	ESV112N01SXB, ESV112N01SX*	M32 A	C32 A	30A	4	10
240V 1~ (2/PE)	ESV251N01SXB, ESV251N02SXB, ESV371N01SXB, ESV371N02YXB, ESV371N02SF*	M10 A	C10 A	10 A	1.5	14
	ESV751N01SXB, ESV751N02YXB, ESV751N02SF*	M16 A	C16 A	15 A	2.5	14
	ESV112N02YXB, ESV112N02SFC, ESV112N01SXB, ESV112N01SX*	M20 A	C20 A	20 A	2.5	12
	ESV152N02YXB, ESV152N02SF*	M25 A	C25 A	25 A	2.5	12
	ESV222N02YXB, ESV222N02SF*	M32 A	C32A	30 A	4	10
	ESV371N02YXB, ESV751N02YXB, ESV371N02Y_*, ESV751N02Y_*	M10 A	C10 A	10 A	1.5	14
240V 3~ (3/PE)	ESV112N02YXB, ESV152N02YXB, ESV112N02TXB, ESV152N02TXB, ESV112N02Y_*, ESV152N02Y_*	M16 A	C16 A	12 A	1.5	14
	ESV222N02YXB, ESV222N02TXB, ESV222N02YX*	M20 A	C20 A	20 A	2.5	12
	ESV402N02TXB, ESV402N02T_*	M32 A	C32 A	30 A	4.0	10
	ESV552N02TXB, ESV552N02T_*	M40 A	C40 A	35 A	6.0	8
	ESV752N02TXB, ESV752N02T_*	M50 A	* use Fuse only	45 A *	10	8
	ESV113N02TXB, ESV113N02TX--, ESV113N02TM--	M80 A	* use Fuse only	80 A *	16	6
	ESV153N02TXB, ESV153N02TX--, ESV153N02TM--	M100 A	* use Fuse only	90 A *	16	4
	ESV371N04TXB ...ESV222N04TXB, ESV371N04T_*, ...ESV222N04T_*, ESV371N04TF* ...ESV222N04TF*	M10 A	C10 A	10 A	1.5	14
	ESV302N04T_*	M16 A	C16 A	15 A	2.5	14
	ESV402N04TXB, ESV402N04T_*	M16 A	C16 A	20 A	2.5	14
400V or 480V 3~(3/PE)	ESV552N04TXB, ESV552N04T_*	M20 A	C20 A	20 A	2.5	14
	ESV752N04TXB, ESV752N04T_*	M25 A	C25 A	25 A	4.0	10
	ESV113N04TXB, ESV113N04T_*	M40 A	* use Fuse only	40 A *	4	8
	ESV153N04TXB, ESV153N04T_*	M50 A	* use Fuse only	50 A *	10	8
	ESV183N04TXB, ESV183N04T_*	M63 A	* use Fuse only	70 A *	10	6
	ESV223N04TXB, ESV223N04T_*	M80 A	* use Fuse only	80 A *	16	6
	ESV303N04TXB	M100 A	* use Fuse only	100 A *	25	4
	ESV373N04TXB	M125 A	* use Fuse only	125 A *	35	2
	ESV453N04TXB	M160 A	* use Fuse only	150 A *	35	1
	600V 3~(3/PE)	ESV751N06TXB ...ESV222N06TXB, ESV751N06T_*, ...ESV222N06T_*	M10 A	C10 A	10 A	1.5
ESV402N06TXB, ESV402N06T_*		M16 A	C16 A	12 A	1.5	14
ESV552N06TXB, ESV552N06T_*		M16 A	C16 A	15 A	2.5	14
ESV752N06TXB, ESV752N06T_*		M20 A	C20 A	20 A	2.5	12
ESV113N06TXB, ESV113N06TX--, ESV113N06TM--		M32 A	C32 A	30 A	4	10
ESV153N06TXB, ESV153N06TX--, ESV153N06TM--		M40 A	* use Fuse only	40 A *	4	8
ESV183N06TXB, ESV183N06TX--, ESV183N06TM--		M50 A	* use Fuse only	50 A *	6	8
ESV223N06TXB, ESV223N06TX--, ESV223N06TM--		M63 A	* use Fuse only	60 A *	10	8
ESV303N06TXB		M80 A	* use Fuse only	70 A *	16	6
ESV373N06TXB		M100 A	* use Fuse only	90 A *	16	4
ESV453N06TXB		M125 A	* use Fuse only	110 A *	25	2



Notes for Fuse and Cable Table:

- (1) Installations with high fault current due to large supply mains may require a type D circuit breaker.
- (2) UL Class CC or T fast-acting current-limiting type fuses, 200,000 AIC, preferred. Bussman KTK-R, J/JN or JJS or equivalent.
- (3) Thermomagnetic type breakers preferred.

- _ 11th digit of part number: F = Integral EMC Filter
 L = Integral EMC Filter and Integrated Disconnect Switch (NEMA 4X/IP65 Models only)
 M = Integrated Disconnect Switch (NEMA 4X/IP65 Models only)
 X = No EMC Filter/ No Disconnect Switch
- * = Last digit of part number: C = N4X Indoor only (convection cooled)
 E = N4X Indoor/Outdoor (convection cooled)
 D = N4X Indoor only (fan cooled)
 F = N4X Indoor/Outdoor (fan cooled)

Observe the following when using Ground Fault Circuit Interrupters (GFCIs):

- Installation of GFCI only between supplying mains and controller.
- The GFCI can be activated by:
 - capacitive leakage currents between the cable screens during operation (especially with long, screened motor cables)
 - connecting several controllers to the mains at the same time
 - RFI filters

3.2.3 Control Terminals

Control Terminal Strip for 0.33 - 10 HP (0.25 - 7.5 kW):

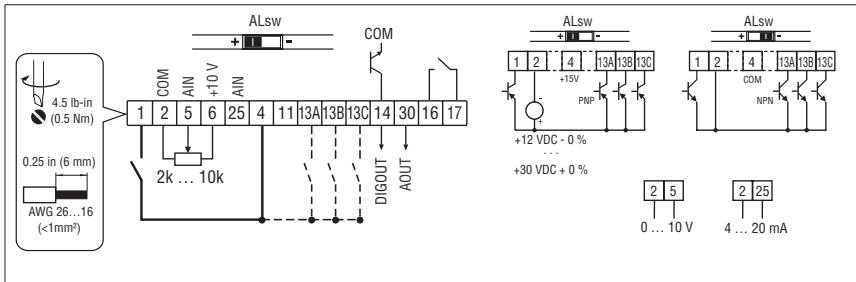

Control Terminal Strip for 15HP (11 kW) and Greater Drives:

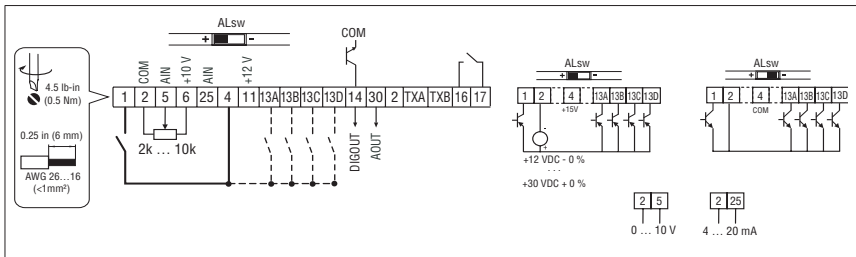

NOTE

Control and communications terminals provide basic insulation when the drive is connected to a power system rated up to 300V between phase to ground (PE) and the applied voltage on terminals 16 and 17 is less than 250 VAC between phase to phase and ground (PE).



Installation

Control Terminal Strip Descriptions

Terminal	Description	Important
1	Digital Input: Start/Stop	input resistance = 4.3k Ω
2	Analog Common	
5	Analog Input: 0...10 VDC	input resistance: >50 k Ω
6	Internal DC supply for speed pot	+10 VDC, max. 10 mA
25	Analog Input: 4...20 mA	input resistance: 250 Ω
4	Digital Reference/Common	+15 VDC / 0 VDC, depending on assertion level
11	Internal DC supply for external devices	+12 VDC, max. 50 mA
13A	Digital Input: Configurable with P121	input resistance = 4.3k Ω
13B	Digital Input: Configurable with P122	
13C	Digital Input: Configurable with P123	
13D*	Digital Input: Configurable with P124	
14	Digital Output: Configurable with P142, P144	DC 24 V / 50 mA; NPN
30	Analog Output: Configurable with P150...P155	0...10 VDC, max. 20 mA
2*	Analog Common	
TXA*	RS485 TxA	
TXB*	RS485 TxB	
16	Relay output: Configurable with P140, P144	AC 250 V / 3 A
17		DC 24 V / 2 A ... 240 V / 0.22 A, non-inductive

* = Terminal is part of the terminal strip for the 15HP (11kW) and higher models only.

Assertion level of digital inputs

The digital inputs can be configured for active-high or active-low by setting the Assertion Level Switch (ALsw) and P120. If wiring to the drive inputs with dry contacts or with PNP solid state switches, set the switch and P120 to "High" (+). If using NPN devices for inputs, set both to "Low" (-). Active-high (+) is the default setting.

HIGH = +12 ... +30 V

LOW = 0 ... +3 V



NOTE

An **F_AL** fault will occur if the Assertion Level switch (ALsw) position does not match the parameter P120 setting and P100 or any of the digital inputs (P121...P124) is set to a value other than 0.



4 Commissioning

4.1 Local Keypad & Display

SMV Models: 0.33-10HP (0.25-7.5kW)	SMV Models: 15HP (11kW) and greater
4-Character Display	4-Character plus CTRL Display

Display	START BUTTON
	In Local Mode (P100 = 0, 4, 6), this button will start the drive.
	STOP BUTTON
	Stops the drive, regardless of which mode the drive is in. WARNING! When JOG is active, the STOP button will not stop the drive!
	ROTATION
	In Local Mode (P100 = 0, 4, 6), this selects the motor rotation direction: <ul style="list-style-type: none"> - The LED for the present rotation direction (FWD or REV) will be on - Press R/F; the LED for the opposite rotation direction will blink - Press M within 4 seconds to confirm the change - The blinking direction LED will turn on, and the other LED will turn off When rotation direction is changed while the drive is running, the commanded direction LED will blink until the drive is controlling the motor in the selected direction. Rotation is set in P112. When P112 = 0, rotation is forward only. When P112 = 1 rotation is forward and reverse.
	MODE
	Used to enter/exit the Parameter Menu when programming the drive and to enter a changed parameter value.
	UP AND DOWN BUTTONS
	Used for programming and can also be used as a reference for speed, PID setpoint, or torque setpoint. When the ▲ and ▼ buttons are the active reference, the middle LED on the left side of the display will be on.



Commissioning

Display	INDICATING LEDs (on 4-character display)		
	FWD LED: Indicate the present rotation direction is forward. Refer to ROTATION description above.		
	REV LED: Indicate the present rotation direction is reverse. Refer to ROTATION description above.		
	AUTO LED: Indicates that the drive has been put into Auto mode from one of the TB13 inputs (P121...P124 set to 1...7). Indicates that PID mode is active (if PID mode is enabled). Indicates that sequencer mode is active (if sequencer mode is enabled).		
	RUN LED: Indicates that the drive is running.		
	▲ ▼ LED: Indicates that the ▲ ▼ are the active reference.		
	NOTE If the keypad is selected as the auto reference (P121...P124 is 6) and the corresponding TB-13 input is closed, the AUTO LED and ▲ ▼ LEDs will both be on.		
FUNCTIONS THAT FOLLOW ARE APPLICABLE TO SMV DRIVES 15HP (11kW) AND HIGHER			
CTRL	CTRL The CTRL pushbutton selects the start and speed reference control sources for the drive. Press mode button to accept the new control mode selection.		
	CTRL LEDS	START CONTROL	REFERENCE CONTROL
	[LOCAL] [MAN]	Keypad	P101 Settings
	[LOCAL] [AUTO]	Keypad	Terminal 13x Settings
	[REMOTE] [MAN]	Terminal Strip	P101 Settings
	[REMOTE] [AUTO]	Terminal Strip	Terminal 13x Settings
If P100 = 6 the CTRL button is used to toggle start control between the terminal strip [REMOTE] and the keypad [LOCAL]		- REM/LOC LED indicating the present start control source is ON - Press [CTRL]; the LED for other start control source will blink - Press [M] within 4 sec to confirm the change - Blinking LED will turn ON (the other LED will turn OFF)	
If P113 = 1 the CTRL button is used to toggle reference control between the TB-13x setup [AUTO] and P101 [MANUAL]		- AUT/MAN LED indicating present reference control is ON - Press [CTRL]; the other reference control will blink - Press [M] within 4 sec to confirm change - Blinking LED will turn ON (the other LED will turn OFF)	
If P100 = 6 and P113 = 1, it is possible to change the start and reference control sources at the same time			



Display	START CONTROL	
	The REMOTE/LOCAL LEDs indicate the current start control source. If the start control source is a remote keypad or the network, then both LEDs will be OFF.	
	REFERENCE CONTROL	
	The AUTO/MANUAL LEDs indicate the current reference control source.	
	IF P113 = 0 or 2, the AUTO/MANUAL LEDs will match the AUTO LED on the 4-character display. IF P113 = 0 and no AUTO reference has been setup on the terminal strip, the MANUAL LED will turn ON and the AUTO LED will turn OFF.	
	IF P113 = 1, the AUTO/MANUAL LEDs show the commanded reference control source as selected by the [CTRL] button. If the [CTRL] button is used to set the reference control source to AUTO but no AUTO reference has been setup on the terminal strip, reference control will follow P101 but the AUTO LED will remain ON.	
	UNITS LEDs	
	HZ: current display value is in Hz	In Speed mode, if P178 = 0 then HZ LED will be ON. If P178 > 0, the Units LEDs follow the setting of P177 when the drive is in run (non-programming) mode. In Torque mode, the HZ LED will be ON when the drive is in run (non-programming) mode. In Pid mode, the Units LEDs follow the setting of P203 when the drive is in run (non-programming) mode. If P179 > 0, the Units LEDs will show the unit of the diagnostic parameter that is being displayed.
	%: current display value is in %	
	RPM: current display value is in RPM	
	AMPS: current display value is in Amps	
	/UNITS current display value is a per unit (i.e./sec, /min, /hr, etc.)	

4.2 Drive Display and Modes of Operation

Speed Mode Display

In the standard mode of operation, the drive frequency output is set directly by the selected reference (keypad, analog reference, etc.). In this mode, the drive display will show the drive's output frequency.

PID Mode Display

When the PID mode is enabled and active, the normal run display shows the actual PID setpoint. When PID mode is not active, the display returns to showing the drive's output frequency.

Torque Mode Display

When the drive is operating in Vector Torque mode, the normal run display shows the drive's output frequency.

Alternate (Run-Screen) Display

When P179 (Run Screen Display) is set to a value other than 0, one of the diagnostic parameters (P501...P599) is displayed. Example: if P179 is set to 1, then diagnostic parameter P501 (Software version) is displayed. If P179 = 2, then P502 (Drive ID) is displayed.



Commissioning

4.3 Parameter Setting

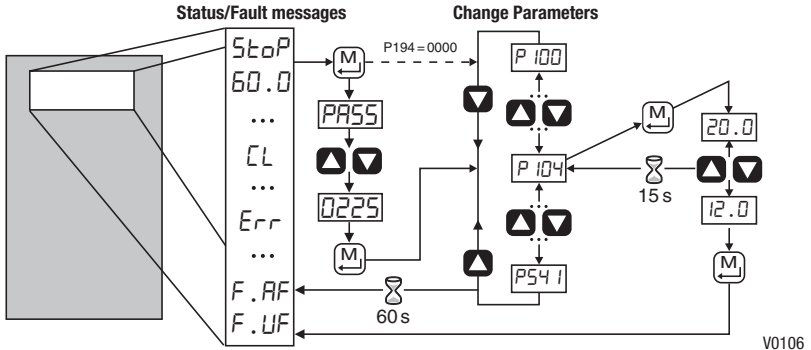

4.4 Electronic Programming Module (EPM)

The EPM contains the drives operational memory. Parameter settings are stored in the EPM and setting changes are made to the "User settings" in the EPM.

An optional EPM Programmer (model EEPROM1RA) is available that allows:

- An EPM to be copied directly to another EPM.
- An EPM to be copied to the memory of the EPM Programmer.
- Stored files can be modified in the EPM Programmer.
- Stored files can be copied to another EPM.

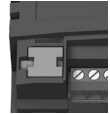

EPM Module
in SMV Drive

As the EPM Programmer is battery operated, parameter settings can be copied to an EPM and inserted into a drive without power being applied to the drive. This means that the drive will be fully operational with the new settings on the next application of power.

Additionally, when the drives parameter settings are burned into an EPM with the EPM Programmer, the settings are saved in two distinct locations; the "User settings" and the "OEM default settings". While the User settings can be modified in the drive, the OEM settings cannot. Thus, the drive can be reset not only to the "factory" drive default settings (shown in this manual), but can be set to the Original Machine settings as programmed by the OEM.

The user area contents of the EPM are what are copied into the OEM space by the EPM programmer. When parameter modifications are made to the drive and then a copy made via the EPM Programmer, these are the settings that will be available by the OEM selections from P199. The EPM Programmer is the only way to load the OEM area of the EPM.

While the EPM can be removed for copying or to use in another drive, it must be installed for the drive to operate (a missing EPM will trigger an F_F I fault)



4.5 Parameter Menu

4.5.1 Basic Setup Parameters

Code		Possible Settings		IMPORTANT
No.	Name	Default	Selection	
P 100	Start Control Source	0	0 Local Keypad	Use RUN button on front of drive to start
			1 Terminal Strip	Use start/stop circuit wired into the terminal strip. Refer to section 3.2.3
			2 Remote Keypad Only	Use RUN button on optional Remote Keypad to start
			3 Network Only	<ul style="list-style-type: none"> Start command must come from network (Modbus, CANopen, etc) SMV models <15HP (11kW) require optional communication module (refer to the network module documentation). Must also set one of the TB-13 inputs to 9 (Network Enable); see P121...P124
			4 Terminal Strip or Local Keypad	Allows start control to be switched between terminal strip and local keypad using one of the TB-13 inputs. See note below.
			5 Terminal Strip or Remote Keypad	Allows start control to be switched between terminal strip and optional remote keypad using one of the TB-13 inputs. See Note below
			6 CTRL button select	Allows start control to be switched between terminal strip and local keypad using the CTRL button. NOTE: P100 Selection 6 is applicable to SMV 15HP (11kW) and higher models only.
			WARNING! P100 = 0 disables TB-1 as a STOP input! STOP circuitry may be disabled if parameters are reset back to defaults (see P199)	
			NOTE <ul style="list-style-type: none"> P100 = 4, 5: To switch between control sources, one of the TB-13 inputs (P121...P124) must be set to 08 (Control Select); TB-13x OPEN (or not configured): Terminal strip control TB-13x CLOSED: Local (P100 = 4) or Remote (P100 = 5) keypad P100 = 0, 1, 4, 6: Network can take control if P121...P124 = 9 and the corresponding TB-13x input is CLOSED. The STOP button on the front of the drive is always active except in JOG mode. TB-1 is an active STOP input if P100 is set to a value other than 0. An F_{RL} fault will occur if the Assertion Level switch (ALsw) position does not match the P120 setting and P100 is set to a value other than 0. 	
P 101	Standard Reference Source	0	0 Keypad (Local or Remote)	Selects the default speed or torque reference when no Auto Reference is selected using the TB-13 inputs.
			1 0-10 VDC	
			2 4-20 mA	
			3 Preset #1 (P131)	
			4 Preset #2 (P132)	
			5 Preset #3 (P133)	
			6 Network	
			7 Preset Sequence Segment #1 (P710)	Selections 7, 8 & 9 are not valid for PID setpoint or torque reference.
			8 Preset Sequence Segment #2 (P715)	
9 Preset Sequence Segment #3 (P720)				





Commissioning

Code		Possible Settings				IMPORTANT
No.	Name	Default	Selection			
P 102	Minimum Frequency	0.0	0.0	{Hz}	P103	<ul style="list-style-type: none"> P102, P103 are active for all speed references When using an analog speed reference, also see P160, P161
P 103	Maximum Frequency	60.0	7.5	{Hz}	500	
			NOTE <ul style="list-style-type: none"> P103 cannot be set below Minimum Frequency (P102) To set P103 above 120 Hz: <ul style="list-style-type: none"> Scroll up to 120 Hz; display shows H Fr (flashing). Release ∇ button and wait one second. Press ∇ button again to continue increasing P103. 			
	WARNING! Consult motor/machine manufacturer before operating above rated frequency. Overspeeding the motor/machine may cause damage to equipment and injury to personnel!					
P 104	Acceleration Time 1	20.0	0.0	{s}	3600	<ul style="list-style-type: none"> P104 = time of frequency change from 0 Hz to P167 (base frequency) P105 = time of frequency change from P167 to 0 Hz For S-ramp accel/decel, adjust P106
P 105	Deceleration Time 1	20.0	0.0	{s}	3600	
	EXAMPLE: IF P103 = 120 Hz, P104 = 20.0 s and P167 (base frequency) = 60 Hz; then the rate of frequency change from 0 Hz to 120 Hz = 40.0 s					
P 106	S-Ramp Integration Time	0.0	0.0	{s}	50.0	<ul style="list-style-type: none"> P106 = 0.0: Linear accel/decel ramp P106 > 0.0: Adjusts S-ramp curve for smoother ramp
P 107 ⁽¹⁾	Line Voltage Selection	1*	0	Low (120, 200, 400, 480VAC)		* The default setting is 1 for all drives except when using "Reset to 50Hz default settings" (Parameter P199, selection 4) with 480V models. In this case, the default setting is 0.
			1	High (120, 240, 480, 600VAC)		
P 108	Motor Overload	100	30	{%}	100	P108 = $\frac{\text{motor current rating}}{\text{SMV output rating}} \times 100$ Example: if motor = 3amps and SMV = 4amps, then P108 = 75%
			NOTE Do not set above rated motor current as listed on the motor dataplate. The motor thermal overload function of the SMV is UL approved as a motor protection device. Cycling power after an overload fault could result in significantly reducing the motor life.			
P 109	Motor Overload Type	0	0	Speed Compensation		
			1	No Speed Compensation Example: Motor is cooled by forced ventilation as apposed to shaft mounted, self cooling fans.		

(1) Any changes to this parameter will not take effect until the drive is stopped.



Code		Possible Settings		IMPORTANT
No.	Name	Default	Selection	
P110	Start Method	0	0 Normal	<p>Drive will automatically start when power is applied.</p> <p>When start command is applied, drive will apply DC braking according to P174, P175 prior to starting the motor</p> <p>Drive will automatically restart after faults, or when power is applied.</p> <p>Combines settings 2 and 3</p> <ul style="list-style-type: none"> • Drive will automatically restart after faults, or when power is applied. • After 3 failed attempts, drive will Auto Restart with DC brake. • P110 = 5, 7: Performs speed search, starting at Max Frequency (P103) • P110 = 6, 8: Performs speed search, starting at the last output frequency prior to faulting or power loss • If P111 = 0, a flying START is performed when a start command is applied. • P110 = 7, 8: Utilizes P280/281 to set Max Current Level and Decel Time for restart
			1 Start on Power-up	
			2 Start with DC Brake	
			3 Auto Restart	
			4 Auto Restart with DC Brake	
			5 Flying Start/Restart - Type 1	
			6 Flying Start/Restart - Type 1	
			7 Flying Start /Restart - Type 2 for 2-pole motors requiring a flying restart	
			8 Flying Start/Restart - Type 2 for 2-pole motors requiring a flying restart	
		 <p>NOTE</p> <ul style="list-style-type: none"> • P110 = 0, 2: Start command must be applied at least 2 seconds after power-up; F_{UF} fault will occur if start command is applied too soon. • P110 = 1, 3...6: For automatic start/restart, the start source must be the terminal strip and the start command must be present. • P110 = 2, 4...6: If P175=999.9, dc braking will be applied for 15s. • P110 = 3...6: Drive will attempt 5 restarts; if all restart attempts fail, drive displays LC (fault lockout) and requires manual reset. • P110 = 5, 6: If drive cannot catch the spinning motor, drive will trip into F_{rF} fault. • P110 = 5, 6: If drive trips into F_{DF} fault, try P110 = 7 or 8. 		
 <p>WARNING! Automatic starting/restarting may cause damage to equipment and/or injury to personnel! Automatic starting/restarting should only be used on equipment that is inaccessible to personnel.</p>				
P111	Stop Method	0	0 Coast	<p>Drive's output will shut off immediately upon a stop command, allowing the motor to coast to a stop</p> <p>The drive's output will shut off and then the DC Brake will activate (refer to P174, P175)</p> <p>The drive will ramp the motor to a stop according to P105 or P126.</p> <p>The drive will ramp the motor to 0 Hz and then the DC Brake will activate (refer to P174, P175)</p>
			1 Coast with DC Brake	
			2 Ramp	
			3 Ramp with DC Brake	
P112	Rotation	0	0 Forward Only	If PID mode is enabled, reverse direction is disabled (except for Jog).
			1 Forward and Reverse	





Commissioning

Code		Possible Settings		IMPORTANT
No.	Name	Default	Selection	
P113	Auto/Manual Control	0	0 Terminal Strip Control	The reference is dictated by the settings and state of the TB-13x terminals. If no AUTO reference has been setup on the terminal strip then reference control is dictated by P101.
			1 Auto/Manual (CTRL button select)	Allows the reference to be switched between auto and manual using the CTRL pushbutton on the drive keypad. If the CTRL pushbutton has selected AUTO reference but no AUTO reference has been setup on the terminal strip, then reference control is dictated by P101.
			2 Manual Control Only	Reference is dictated by P101 regardless of any AUTO source that may be selected by the TB-13x terminals.
			NOTE P113 is applicable to SMV 15HP (11kW) and higher models only.	
P115	MOP Speed Initialization at Power-Up	0	0 Set to last MOP speed at power up	Output frequency at power-up = last MOP speed
			1 Set to 0.0Hz at power up	Output frequency at power-up = 0Hz
			2 Set to Preset #3 (P133) at power up	Output frequency at power-up = P133



4.5.2 I/O Setup Parameters

Code		Possible Settings		IMPORTANT
No.	Name	Default	Selection	
P 120	Assertion Level	2	1 Low	P120 and the Assertion Level switch must both match the desired assertion level unless P100, P121...P124 are all set to 0. Otherwise an F.AL fault will occur.
			2 High	
P 121	TB-13A Digital Input	0	0 None	Disables input
P 122	TB-13B Digital Input (Priority > TB13A) Same as TB13A except: 3 = Preset #2 23 = Seq Seg, #2		1 AUTO Reference: 0-10 VDC	For frequency mode, see P160...P161, For PID mode, see P204...P205, For vector torque mode, see P330
			2 AUTO Reference: 4-20 mA	
P 123	TB-13C Digital Input (Priority > TB13B, A) Same as TB13A except: 3 = Preset #3 23 = Seq Seg, #4		3 AUTO Reference: Preset #1	For frequency mode see P131...P137, For PID mode, see P231...P233, For torque mode see, P331...P333
			* 13D: 3 = Reserved	
P 124	TB-13D* Digital Input (Priority > TB13C, B, A) Same as TB13A except: 3 = Preset #4 23 = Seq Seg, #8		4 AUTO Reference: MOP Up	<ul style="list-style-type: none"> Normally open: Close input to increase or decrease speed, PID or torque setpoint. MOP Up is not active while in STOP
			5 AUTO Reference: MOP Down	
 <p>NOTE: P124 is applicable to SMV 15HP (11kW) and higher models only</p>			6 AUTO Reference: Keypad	Use when P100 = 4, 5 to switch between terminal strip control and local or remote keypad control. Required to start the drive through the network. Open = Forward Closed = Reverse Refer to Note for typical circuit Refer to Note for typical circuit Jog Forward speed = P134 Jog Reverse speed = P135 ⚠ Active even if P112 = 0 Refer to P125, P126 Refer to P174; close input to override P175 Normally closed: Opening input will ramp drive to STOP according to P127, even if P111 is set to Coast (0 or 1). Close to reset fault Normally closed circuit; open to trip Normally open circuit; close to trip Works in Speed Mode only Transition from non-asserted to asserted state
			7 AUTO Reference: Network	
			8 Control Select	
			9 Network Enable	
			10 Reverse Rotation	
			11 Start Forward	
			12 Start Reverse	
			13 Run Forward	
			14 Run Reverse	
			15 Jog Forward	
			16 Jog Reverse	
			17 Accel/Decel #2	
			18 DC Brake	
			19 Auxiliary Ramp to Stop	
20 Clear Fault				
21 External Fault F_EF				
22 Inverse External Fault F_EF				
23 AUTO Ref: Sequence Segment #1				
24 Start Sequence				
25 Step Sequence				
26 Suspend Sequence				
	WARNING Jog overrides all STOP commands! To stop the drive while in Jog mode, the Jog input must be deactivated or a fault condition induced.			
	WARNING If the input defined to "Start Sequence" is opened during a sequence, the drive will exit sequencer mode and will run at the specified standard or alternate speed source (dependent on drive configuration).			



Commissioning

Code		Possible Settings		IMPORTANT																																																								
No.	Name	Default	Selection																																																									
i	NOTE <ul style="list-style-type: none"> When input is activated, settings 1...7 override P101 When TB-13A...TB-13D are configured for Auto References other than MOP, TB-13D overrides TB-13C, TB-13C overrides TB-13B and TB-13B overrides TB-13A. Any other Auto Reference will have priority over MOP. Settings 10...14 are only valid in Terminal Strip mode (P100 = 1, 4, 5, 6) If Start/Run/Jog Forward and Start/Run/Jog Reverse are both activated, drive will STOP If Jog input is activated while drive is running, the drive will enter Jog mode; when Jog input is deactivated, drive will STOP An F_{RL} fault will occur if the Assertion Level switch (ALsw) position does not match the P120 setting and any of the digital inputs (P121...P124) are set to a value other than 0. An F_{IL} fault will occur under the following conditions: <ul style="list-style-type: none"> TB-13A...TB-13D settings are duplicated (each setting, except 0, 3 and 23, can only be used once) One input is set to "MOP Up" and another is not set to "MOP Down", or vice-versa. One input is set to 10 and another input is set to 11...14. One input is set to 11 or 12 and another input is set for 13 or 14. Typical control circuits are shown below: <ul style="list-style-type: none"> If any input is set to 10, 12 or 14, P112 must be set to 1 for Reverse action to function. 																																																											
	<p>Run / Stop with Direction P121 = 10</p>	<p>Start Forward / Start Reverse P121 = 11, P122 = 12</p>	<p>Run Forward / Run Reverse P121 = 13, P122 = 14</p>																																																									
P 125	Acceleration Time 2	20.0	0.0	{s} 3600	<ul style="list-style-type: none"> Selected using TB-13A...TB-13D (P121...P124 = 17) For S-ramp accel/decel, adjust P106 																																																							
P 126	Deceleration Time 2	20.0	0.0	{s} 3600																																																								
P 127	Deceleration Time for Auxiliary Ramp to Stop	20.0	0.0	{s} 3600	<ul style="list-style-type: none"> Selected using TB-13A...TB-13D (P121...P124 = 19). For S-ramp accel/decel, adjust P106 Once executed, this ramp time has priority over P105 and P126. 																																																							
P 129	Automatic Accel/Decel rate switch threshold	0.0	0.0	{Hz} 1000	If Actual Frequency < P129 Use Accel/decel time #2 (P125/P126) If Actual Frequency > P129 Use Accel/decel time #1 (P104/P105)																																																							
P 131	Preset Speed #1	0.0	0.0	{Hz} 500	<table border="1"> <thead> <tr> <th>PRESET SPEED</th> <th>13A</th> <th>13B</th> <th>13C</th> <th>13D</th> </tr> </thead> <tbody> <tr><td>1</td><td>X</td><td>--</td><td>--</td><td>--</td></tr> <tr><td>2</td><td>--</td><td>X</td><td>--</td><td>--</td></tr> <tr><td>3</td><td>--</td><td>--</td><td>X</td><td>--</td></tr> <tr><td>4</td><td>X</td><td>X</td><td>--</td><td>--</td></tr> <tr><td>4 (alternate)</td><td>--</td><td>--</td><td>--</td><td>X</td></tr> <tr><td>5</td><td>X</td><td>--</td><td>X</td><td>--</td></tr> <tr><td>6</td><td>--</td><td>X</td><td>X</td><td>--</td></tr> <tr><td>7</td><td>X</td><td>X</td><td>X</td><td>--</td></tr> <tr><td>8 (alternate)</td><td>--</td><td>X</td><td>--</td><td>X</td></tr> <tr><td>8 (alternate)</td><td>--</td><td>--</td><td>X</td><td>X</td></tr> </tbody> </table>	PRESET SPEED	13A	13B	13C	13D	1	X	--	--	--	2	--	X	--	--	3	--	--	X	--	4	X	X	--	--	4 (alternate)	--	--	--	X	5	X	--	X	--	6	--	X	X	--	7	X	X	X	--	8 (alternate)	--	X	--	X	8 (alternate)	--	--	X	X
PRESET SPEED	13A	13B	13C	13D																																																								
1	X	--	--	--																																																								
2	--	X	--	--																																																								
3	--	--	X	--																																																								
4	X	X	--	--																																																								
4 (alternate)	--	--	--	X																																																								
5	X	--	X	--																																																								
6	--	X	X	--																																																								
7	X	X	X	--																																																								
8 (alternate)	--	X	--	X																																																								
8 (alternate)	--	--	X	X																																																								
P 132	Preset Speed #2	0.0	0.0	{Hz} 500																																																								
P 133	Preset Speed #3	0.0	0.0	{Hz} 500																																																								
P 134	Preset Speed #4	0.0	0.0	{Hz} 500																																																								
P 135	Preset Speed #5	0.0	0.0	{Hz} 500																																																								
P 136	Preset Speed #6	0.0	0.0	{Hz} 500																																																								
P 137	Preset Speed #7	0.0	0.0	{Hz} 500																																																								
P 138	Preset Speed #8	0.0	0.0	{Hz} 500	<ul style="list-style-type: none"> Speed setting is used by P158 13D available on 15HP (11kW) & higher drives. 																																																							

Commissioning



Code		Possible Settings		IMPORTANT
No.	Name	Default	Selection	
P 140	Relay Output TB-16, 17	0	0 None	Disables the output
			1 Run	Energizes when the drive is running
			2 Reverse	Energizes when reverse rotation is active
			3 Fault	De-energizes when the drive trips, or power is removed
			4 Inverse Fault	Energizes when the drive trips
			5 Fault Lockout	P110 = 3...6: De-energizes if all restart attempts fail
			6 At Speed	Energizes when output frequency = commanded frequency
			7 Above Preset Speed #6	Energizes when output frequency > P136
			8 Current Limit	Energizes when motor current = P171
			9 Follower Loss (4-20 mA)	Energizes when 4-20 mA signal is < P164
			10 Loss of Load	Energizes when motor load drops below P145; Refer to P146 also
			11 Local Keypad Control Active	
			12 Terminal Strip Control Active	Energizes when the selected source is active for start control
			13 Remote Keypad Control Active	
			14 Network Control Active	
			15 Standard Reference Active	Energizes when P101 reference is active
			16 Auto Reference Active	Energizes when Auto Reference is activated using TB-13 input; refer to P121...P124
			17 Sleep Mode Active	Refer to P240...P242
			18 PID Feedback < Min. Alarm	Energizes when PID feedback signal < P214
			19 Inverse PID Feedback < Min. Alarm	De-energizes when PID feedback signal < P214
			20 PID Feedback > Max Alarm	Energizes when PID feedback signal > P215
			21 Inverse PID Feedback > Max Alarm	De-energizes when PID feedback signal > P215
			22 PID Feedback within Min/Max Alarm range	Energizes when PID feedback signal is within the Min/Max Alarm range; refer to P214, P215
			23 PID Feedback outside Min/Max Alarm range	Energizes when PID feedback signal is outside the Min/Max Alarm range; refer to P214, P215
			24 Reserved	
			25 Network Controlled	SMV models < 15HP (11kW) require an optional communication module (refer to the network module documentation).
			26 Loss of 0-10V Input	Energizes when 0-10V signal is < P158
			27 Sequencer Controlled	State set in individual sequencer segments
			28 Sequencer Active	
			29 Sequencer Suspended	
			30 Sequence Done	End Sequence
31 Output Frequency = 0.0Hz	Output inactive			
P 142	TB-14 Output	0	0...23 (same as P140)	
			24 Dynamic Braking	For use with Dynamic Braking option
			25...31 (same as P140)	



Commissioning

Code		Possible Settings			IMPORTANT																	
No.	Name	Default	Selection																			
P 144	Digital Output Inversion		<table border="1"> <thead> <tr> <th>P144</th> <th>Invert P142</th> <th>Invert P140</th> </tr> </thead> <tbody> <tr> <td>0</td> <td>NO</td> <td>NO</td> </tr> <tr> <td>1</td> <td>NO</td> <td>YES</td> </tr> <tr> <td>2</td> <td>YES</td> <td>NO</td> </tr> <tr> <td>3</td> <td>YES</td> <td>YES</td> </tr> </tbody> </table>			P144	Invert P142	Invert P140	0	NO	NO	1	NO	YES	2	YES	NO	3	YES	YES	Used to invert the selections for P140 (Relay Output) and P142 (TB-14 Output). EXAMPLE: When P140 = 6 (AT SPEED), the relay is energized when output frequency = commanded frequency. If P144=1 or 3, then P140 is inverted (INVERSE AT SPEED) and the relay is energized when the output frequency does not equal the command frequency.	
			P144	Invert P142	Invert P140																	
			0	NO	NO																	
1	NO	YES																				
2	YES	NO																				
3	YES	YES																				
NOTE Inverting P140 or P142 when the parameter is set to NONE (0) will result in the output being energized continuously.																						
NOTE For SMVector drives rated at 0.33 to 10 HP (0.25 to 7.5 kW), P144 is only available with software versions 3.0 and higher (refer to P501).																						
P 145	Loss of Load Threshold	0	0	{%}	200	P140, P142 = 10: Output will energize if motor load falls below the P145 value longer than the P146 time																
P 146	Loss of Load Delay	0.0	0.0	{s}	240.0																	
P 149	Analog Output Offset	0.0	0	{%}	100	Scaled value. Example: P149 = 10%, Scaled variable = freq, P150 = 1, P152 = 60Hz; then TB30 = 0VDC below 6Hz																
P 150	TB-30 Output	0	0 None			2-10 VDC signal can be converted to 4-20 mA with a total circuit impedance of 500 Ω																
			1 0-10 VDC Output Frequency																			
			2 2-10 VDC Output Frequency																			
			3 0-10 VDC Load																			
			4 2-10 VDC Load																			
			5 0-10 VDC Torque																			
			6 2-10 VDC Torque																			
			7 0-10 VDC Power (kW)																			
			8 2-10 VDC Power (kW)																			
			9 Network Controlled				SMV models < 15HP (11kW) require an optional communication module (refer to the network module documentation).															
10 Sequencer Controlled			Value set in individual sequencer segments																			
P 151	Add Analog Input to TB-30 Output	0	<table border="1"> <thead> <tr> <th>P151</th> <th>Add TB-25 (4-20mA)</th> <th>Add TB-5 (0-10VDC)</th> </tr> </thead> <tbody> <tr> <td>0</td> <td>NO</td> <td>NO</td> </tr> <tr> <td>1</td> <td>NO</td> <td>YES</td> </tr> <tr> <td>2</td> <td>YES</td> <td>NO</td> </tr> <tr> <td>3</td> <td>YES</td> <td>YES</td> </tr> </tbody> </table>			P151	Add TB-25 (4-20mA)	Add TB-5 (0-10VDC)	0	NO	NO	1	NO	YES	2	YES	NO	3	YES	YES	This parameter adds the analog input signal(s) to the TB-30 Output signal. EXAMPLE: If a drive is running at 60Hz with P150 set to 1 (0-10VDC Freq) and P152 set to 240.0Hz, the output at TB-30 would be 2.5VDC. If there is a 2.0VDC signal going into TB-5 and P151 is set to 1 (ADD TB-5), the output at TB-30 would become 4.5VDC.	
			P151	Add TB-25 (4-20mA)	Add TB-5 (0-10VDC)																	
			0	NO	NO																	
			1	NO	YES																	
2	YES	NO																				
3	YES	YES																				
P151																						
Add TB-25 (4-20mA)																						
Add TB-5 (0-10VDC)																						
P 152	TB-30 Scaling: Frequency	60.0	3.0	{Hz}	2000	If P150 = 1 or 2, sets the frequency at which output equals 10 VDC																
P 153	TB-30 Scaling: Load	200	10	{%}	500	If P150 = 3 or 4, sets the Load (as a percent of drive current rating) at which output equals 10 VDC.																
P 154	TB-30 Scaling: Torque	100	10	{%}	1000	If P150 = 5 or 6, sets the Torque (as a percent of motor rated torque) at which output equals 10 VDC																
P 155	TB-30 Scaling: Power (kW)	1.0	0.1	{kW}	200.0	If P150 = 7 or 8, sets the power at which output equals 10 VDC																



4.5.3 Advanced Setup Parameters

Code		Possible Settings			IMPORTANT
No.	Name	Default	Selection		
P 156	Analog Inputs Configuration	0	0 TB5: (0-10 VDC); TB25: (4-20mA) 1 TB5: (0 - 5 VDC); TB25: (4-20mA) 2 TB5: (2 - 10 VDC); TB25: (4-20mA) 4 TB5: (0-10 VDC); TB25: (0-20mA) 5 TB5: (0 - 5 VDC); TB25: (0-20mA) 6 TB5: (2 - 10 VDC); TB25: (0-20mA)		
P 157	TB5 (0-10V) Analog Input Monitoring Action	0	0 No Action 1 If TB5 < P158 - Trip Fault F_FRU 2 If TB5 < P158 - Run Preset #8 3 If TB5 < P158 - Run Preset Seg. #16 4 If TB5 > P158 - Trip Fault F_FRU 5 If TB5 > P158 - Run Preset #8 6 If TB5 > P158 - Run Preset Seg. #16		Selects the reaction to a loss of the 0-10V signal at TB5 500ms is the minimum time above/below Monitoring Level (P158) before triggering the drive to trip or run at a preset speed. For P157 = 3 or 6, the accel/decel time is set in P786. NOTE: P157 has priority over P163 and TB-13 presets/auto references (P121-P124)
P 158	TB5 (0-10V) Analog Input Monitoring Level (ML)	0.0	-10.0	{VDC} 10.0	Negative input voltage is not currently supported.
P 159	0-10V Analog Input Deadband	0.0	0	{VDC} 10.0	Not active if [-10 to +10 VDC] option is selected.
P 160	Speed at Minimum Signal	0.0	-999.0	{Hz} 1000	<p style="text-align: right;">V0111</p>
P 161	Speed at Maximum Signal	60.0	-999.0	{Hz} 1000	
			NOTE <ul style="list-style-type: none"> • P160 sets the output frequency at 0% analog input • P161 sets the output frequency at 100% analog input • P160 or P161 < 0.0 Hz: For scaling purposes only; does not indicate opposite direction! • P160 > P161: Drive will react inversely to analog input signal 		
P 162	Analog Input Filter	0.01	0.00	{s} 10.00	<ul style="list-style-type: none"> • Adjusts the filter on the analog inputs (TB-5 and TB-25) to reduce the effect of signal noise • The P162 delay time will affect the response time of diagnostic parameters (P520-P523).
P 163	TB-25 (4-20mA) Analog Input Monitoring Action	0	0 No Action 1 If TB25 < P164 - Trip Fault F_FaL 2 If TB25 < P164 - Run Preset #7 3 If TB25 < P164 - Run Preset Seg. #15 4 If TB25 ≥ P164 - Trip Fault F_FaL 5 If TB25 ≥ P164 - Run Preset #7 6 If TB25 ≥ P164 - Run Preset Seg. #15		<ul style="list-style-type: none"> • Selects the reaction to a loss of the 4-20 mA signal at TB-25. • Signal is considered lost if it falls below the value set in P164 • Digital outputs can also indicate a loss of 4-20 mA signal; see P140, P142 • For P163 = 3 or 6, the accel/decel time is set in P781. NOTE: P163 has priority over TB-13 presets/auto references (P121-P124)



Commissioning

Code		Possible Settings				IMPORTANT
No.	Name	Default	Selection			
P 164	TB-25 (4-20mA) Analog Input Monitoring Level	2.0	0.0	{mA}	20.0	
P 165	Base Voltage		15	{V}	1000	Valid for V/Hz mode only. Set voltage for bus compensation in V/Hz mode
P 166	Carrier Frequency	See Notes	0 1 2 3	4 kHz 6 kHz 8 kHz 10 kHz		<ul style="list-style-type: none"> As carrier frequency is increased, motor noise is decreased Observe derating in section 2.3 Automatic shift to 4 kHz at 120% load NEMA 4X (IP65) Models: Default = 0 (4kHz) NEMA 1 (IP31) Models: Default = 1 (6kHz)
P 167 ⁽¹⁾	Base Frequency	60.0	10.0	{Hz}	1500	<p style="text-align: right;">V0112</p>
P 168	Fixed Boost		0.0	{%}	40.0	
			NOTE <ul style="list-style-type: none"> P167 = rated motor frequency for standard applications P165, P168 = default setting depends on drive rating 			
P 169	Accel Boost	0.0	0.0	{%}	20.0	Accel Boost is only active during acceleration
P 170	Slip Compensation	0.0	0.0	{%}	40.0	Increase P170 until the motor speed no longer changes between no load and full load conditions.
P 171 ⁽¹⁾	Current Limit	Max I	30	{%}	Max I	<ul style="list-style-type: none"> When the limit is reached, the drive displays CL (Current Limit), and either the acceleration time increases or the output frequency decreases. Digital outputs can also indicate when the limit is reached; see P140, P142. Refer to section 2.3 for the maximum output current Max I (%)
P 172	Current Limit Reduction	0	0 1 2 3	Current Limit Reduction Active - Normal response Current Limit Reduction Active - Fast response Current Limit Reduction Disabled - Normal response Current Limit Reduction Disabled - Fast response		In field weakening, the Current Limit is inversely proportional to the speed.
P 173	Decel Override Time	2.0	0.0	{s}	60.0	Maximum time before drive trips into HF fault.
P 174	DC Brake Voltage	0.0	0.0	{%}	50.0	Setting is a percent of the nominal DC bus voltage.

(1) Any changes to this parameter will not take effect until the drive is stopped.

Commissioning



Code		Possible Settings			IMPORTANT	
No.	Name	Default	Selection			
P 175	DC Brake Time	0.0	0.0	{s}	999.9	<p>NOTE: CONFIRM MOTOR SUITABILITY FOR USE WITH DC BRAKING</p> <p>DC Brake voltage (P174) is applied for the time specified by P175 with the following exceptions:</p> <ul style="list-style-type: none"> If P111=1, 3 and P175=999.9 the brake voltage will be applied continuously until a run or fault condition occurs. If P110=2, 4...6 and P175=999.9, brake voltage will be applied for 15s If P121...P124=18 and the corresponding TB-13 input is CLOSED, brake voltage will be applied until the TB-13 input is OPENED or a fault condition occurs.
P 176	Keypad Setpoint Single Press Increment	0.1	0.1		100.0	Used for run screen setpoint editing only. If P176 > 0.1 then scrolling of keypad setpoint is enabled.
P 177 [Ⓜ]	Speed Units	0	0	Hz		Select the UNITS LED that will be illuminated when the drive is running in speed control mode. For this parameter to be used, P178 must be set to a value other than 0. If P178 is set to 0, the Hz LED will be illuminated regardless of the value set in P177.
			1	RPM		
			2	%		
			3	/UNITS		
4	NONE					
P 178	Display Frequency Multiplier	0.00	0.00		650.00	<ul style="list-style-type: none"> Allows frequency display to be scaled P178 = 0.00: Scaling disabled P178 > 0.00: Display = Actual Frequency X P178
P 179	Run Screen Display	0	0	{Parameter Number}	599	<ul style="list-style-type: none"> 0 = Normal Run Screen, this display depends on mode of operation. Refer to section 4.2. Other selections choose a diagnostic parameter to display (P501...P599). Parameters P560 - P564 are selectable if the sequencer is enabled (P700 is not 0). P560-P564 are not visible until P700 is enabled.
P 180	Oscillation Damping Control	0	0		80	0 = Damping disabled Compensation for resonances within drive
P 181	Skip frequency 1	0.0	0.0	{Hz}	500	<ul style="list-style-type: none"> Drive will not run in the defined skip range; used to skip over frequencies that cause mechanical vibration P181 and P182 define the start of the skip ranges P184 > 0 defines the bandwidth of both ranges.
P 182	Skip frequency 2	0.0	0.0	{Hz}	500	
P 184	Skip frequency bandwidth	0.0	0.0		{Hz}	
P 185	Voltage Midpoint V/Hz characteristic	0	0.0	{V}	P165	Valid only when P300 = 0 or 2. Use with P187 to define midpoint on V/Hz curve.
P 187 [Ⓜ]	Frequency Midpoint V/Hz characteristic	0.0	0.0	{Hz}	P167	Valid only when P300 = 0 or 2. Use with P185 to define midpoint on V/Hz curve.
P 189 [Ⓜ]	Integrated Dynamic Brake	0	Disabled			
			1	Enabled		

(2) Parameter applicable to SMV models 15HP (11kW) and higher.

(3) Parameter applicable to SMV models 40HP (30kW) and higher.



Commissioning

Code		Possible Settings		IMPORTANT
No.	Name	Default	Selection	
P 190	Motor Braking		0 Disabled	Flux brake OFF.
			1 Braking with BUS threshold	When drive is in deceleration and $V_{bus} > V_{deceleration\ brake}$ (114% of the rated V_{bus}), the flux brake will be turned ON.
			2 Braking always on with deceleration	As long as drive is in deceleration, the flux brake will be ON.
			3 Braking with bus regulator	When drive is in deceleration and $V_{bus} > V_{deceleration\ brake}$ (114% of the rated V_{bus}), the motor speed will be increased to reduce the bus voltage. Determined by the value in P191, the speed increment = slip speed * P191(%) / 37.
			4 Special	(Consult factory before using)
		WARNING Flux braking can cause heat in the motor. To avoid damage to the motor, use a PTC to protect the motor. If the flux brake is used too frequently, the drive will trip fault "F_PF".		
P 191	Motor Brake Level	0	0 (%) 75 (flux braking disabled)	Active when P190 > 0 and drive is in deceleration mode. Use to reduce deceleration time on high inertia loads. NOTE: Over usage of P190 can cause frequent 'overload' trips "F.PF" Not active for P300 = 5 (Torque mode)
P 192	Motor Braking Deceleration Reduction Level	0.0	0 P167 (base freq) Raising the value of P191 reduces the drive deceleration rate during flux braking.	Active when P190 > 0 and P192 > 0.0. Drive is in deceleration mode. Use to reduce deceleration time on high inertia loads. NOTE: Usage of P192 can cause the drive to decelerate faster than settings in P105/P127. Not active for P300 = 5 (Torque mode)
P 194	Password	0	0000 9999	<ul style="list-style-type: none"> Must enter password to access parameters P194 = 0000: Disables password
P 197	Clear Fault History	0	0 No Action 1 Clear Fault History	
P 199	Program Selection		0 Operate from User settings	
			1 Operate from OEM settings	Refer to Notes 1, 2 and 3
			2 Reset to OEM default settings	Refer to Note 1
			3 Reset to 60 Hz default settings	<ul style="list-style-type: none"> Refer to Note 4 Parameters are reset to the defaults listed in this manual. For P199=4, the following exceptions apply: <ul style="list-style-type: none"> - P103, P152, P161, P167 = 50.0 Hz - P165 = 400V (400/480V drives only) - P304 = 50 Hz - P305 = 1450 RPM - P107 = 0 (480 V drives only)
			4 Reset to 50 Hz default settings	
			5 Translate	Refer to Note 5
		WARNING! Modification of P199 can affect drive functionality! STOP and EXTERNAL FAULT circuitry may be disabled! Check P100 and P121...P124		
		NOTE 1 If the EPM does not contain valid OEM settings, a flashing GF will be displayed when P199 is set to 1 or 2. NOTE 2 When P199 is set to 1, the drive operates from the OEM settings stored in the EPM Module and no other parameters can be changed (GE will be displayed if attempted). NOTE 3 Auto Calibration is not possible when operating from OEM Settings. NOTES 4 and 5 - on next page.		



Code		Possible Settings		IMPORTANT
No.	Name	Default	Selection	
P199	Program Selection		<p>NOTE 4 Resetting to 50 and 60 Hz default settings will set the Assertion Level (P120) to "2" (High). P120 may need to be reset for the digital input devices being used. An F_{AL} fault may occur if P120 and the Assertion switch are not set identically.</p> <p>NOTE 5 If an EPM that contains data from a previous compatible software version is installed:</p> <ul style="list-style-type: none"> The drive will operate according to the previous data, but parameters cannot be changed (cE will be displayed if attempted) To update the EPM to the current software version, set P199 = 5. The parameters can now be changed but the EPM is incompatible with previous software revisions. 	

4.5.4 PID Parameters

Code		Possible Settings		IMPORTANT	
No.	Name	Default	Selection		
P200	PID Mode	0	0 Disabled 1 Normal-acting 2 Reverse-acting 3 Normal-acting, Bi-directional 4 Reverse-acting, Bi-directional	<ul style="list-style-type: none"> Normal-acting: As feedback increases, motor speed decreases Reverse-acting: As feedback increases, motor speed increases PID mode is disabled in Vector Torque mode (P300 = 5) Selections 3, 4: If P112=1, PID controller output sets the speed, (range -max freq to +max freq) 	
			<p>NOTE To activate PID mode, one of the TB-13 inputs (P121...P124) must be used to select the Auto Reference that matches the desired PID setpoint reference. If the selected PID setpoint reference uses the same analog signal as the PID feedback (P201), an F_L fault will occur. Example: The desired PID setpoint reference is the keypad (▲ and ▼). Set TB-13x = 6 (Auto Reference: Keypad):</p> <ul style="list-style-type: none"> TB-13x = closed: PID mode is active TB-13x = open: PID mode is disabled and the drive speed will be controlled by the reference selected in P101. 		
P201	PID Feedback Source	0	0 4-20 mA (TB-25) 1 0-10 VDC (TB-5) 2 Drive Load (P507) 3 Feedback from Network	Must be set to match the PID feedback signal	
P202	PID Decimal Point	1	0 PID Display = XXXX 1 PID Display = XXX.X 2 PID Display = XX.XX 3 PID Display = X.XXX 4 PID Display = .XXXX	Applies to P204, P205, P214, P215, P231...P233, P242, P522, P523	
P203	PID Units	0	0 % 1 /UNITS 2 AMPS 3 NONE	Select the UNITS LED that will be illuminated when the drive is running in PID control mode	
P204	Feedback at Minimum Signal	0.0	-99.9	3100.0	Set to match the range of the feedback signal being used
P205	Feedback at Maximum Signal	100.0	-99.9	3100.0	Example: Feedback signal is 0 - 300 PSI; P204 = 0.0, P205 = 300.0

(2) Parameter applicable to SMV models 15HP (11kW) and higher.



Commissioning

Code		Possible Settings				IMPORTANT
No.	Name	Default	Selection			
P207	Proportional Gain	5.0	0.0	{%}	1000.0	Used to tune the PID loop: <ul style="list-style-type: none"> • Increase P207 until system becomes unstable, then decrease P207 by 10-15% • Next, increase P208 until feedback matches setpoint • If required, increase P209 to compensate for sudden changes in feedback
P208	Integral Gain	0.0	0.0	{s}	20.0	
P209	Derivative Gain	0.0	0.0	{s}	20.0	
			NOTE <ul style="list-style-type: none"> • Derivative Gain is very sensitive to noise on the feedback signal. Use with care. • Derivative Gain is not normally required in pump and fan applications 			
P210	PID Setpoint Ramp	20.0	0.0	{s}	100.0	<ul style="list-style-type: none"> • time of setpoint change from P204 to P205 or vice versa. • Used to smooth the transition from one PID setpoint to another, such as when using the Preset PID Setpoints (P231...P233)
P214	Minimum Alarm	0.0	P204		P205	Use with P140, P142 = 18...23
P215	Maximum Alarm	0.0	P204		P205	
P231	Preset PID Setpoint #1	0.0	P204		P205	TB-13A activated; P121 = 3 and P200 = 1 or 2
P232	Preset PID Setpoint #2	0.0	P204		P205	TB-13B activated; P122 = 3 and P200 = 1 or 2
P233	Preset PID Setpoint #3	0.0	P204		P205	TB-13C activated; P123 = 3 and P200 = 1 or 2
P234	Preset PID Setpoint #4	0.0	P204		P205	TB-13D activated; P124 = 3 and P200 = 1 or 2
P240	Sleep Threshold	0.0	0.0	{Hz}	500.0	<ul style="list-style-type: none"> • If drive speed < P240 for longer than P241, output frequency = 0.0 Hz; drive display = SLP • P240 = 0.0: Sleep mode is disabled. • P200 = 0...2: Drive will start again when speed command is above P240 • P242 > 0.0: Drive will restart when the PID feedback differs from the setpoint by more than the value of P242 or when the PID loop requires a speed above P240.
P241	Sleep Delay	30.0	0.0	{s}	300.0	
P242	Sleep Bandwidth	0.0	0.0		B_{max}	
			Where: $B_{max} = I(P205 - P204)$			
P243	Feedback Sleep Entry Threshold	0.0	P204		P205	Active only when P244 = 1 or 2
P244	Sleep Entry Mode	0	0 Enter SLEEP if Drive Speed <P240			For time longer than P241
			1 Enter SLEEP if Feedback >P243			For time longer than P241 or same as Sel 0
			2 Enter SLEEP if Feedback <P243			For time longer than P241 or same as Sel 0
P245	Sleep Entry Stop Type	0	0 Coast to Stop			
			1 Ramp to Stop			
			2 Stop with P111 settings			
P246	Feedback Recovery from Sleep Threshold	0.0	P204		P205	Active only when P247 = 1 or 2
P247	Sleep Recovery Mode	0	0 Recovery if Speed Setpoint > P240 or if PID feedback differs from setpoint by more than P242			
			1 Recovery only if Feedback < P246			
			2 Recovery only if Feedback > P246			

(2) Parameter applicable to SMV models 15HP (11kW) and higher.



Code		Possible Settings			IMPORTANT
No.	Name	Default	Selection		
P250	Auto Rinse in Sleep Mode	0	0 Disabled 1 Enabled		Activated in sleep mode only. Sleep Recovery cancels Auto Rinse
P251	Time Delay between Auto Rinses	30.0	0.0 {min}	6553.5	Time delay reset by re/entering sleep mode
P252	Auto Rinse Speed	0.0	-500.0 {Hz}	500.0	If P112 = 1, negative sign = reverse direction
P253	Auto Rinse Time	0.0	0.0 {sec}	6553.5	Does not include time to decel back to speed
			Auto Pump Rinse Setup: P250=1 (Enabled) P251=# minutes between each PumpRinse P252=Hz speed of Pump Rinse P253=# seconds Pump Rinse duration		
P280	Current Level: Flying Restart Type 2	70.0	0.0 {%}	P171	Maximum current during Type 2 flying restart operation
P281	Decel Time: Flying Restart Type 2	3.0	0.0 {sec}	3600.0	Deceleration rate used during Type 2 flying restart operation

4.5.5 Vector Parameters

Code		Possible Settings			IMPORTANT
No.	Name	Default	Selection		
P300 ⁽¹⁾	Drive Mode	0	0 Constant V/Hz		Constant torque V/Hz control for general applications Variable torque V/Hz control for centrifugal pump and fan applications
			1 Variable V/Hz		
			2 Enhanced Constant V/Hz		For single or multiple motor applications that require better performance than settings 0 or 1, but cannot use Vector mode, due to:
			3 Enhanced Variable V/Hz		
			4 Vector Speed		For single-motor applications requiring higher starting torque and speed regulation
			5 Vector Torque		For single-motor applications requiring torque control independent of speed
			NOTE To configure the drive for either Vector mode or Enhanced V/Hz mode: <ul style="list-style-type: none"> P300 = 4, 5: <ul style="list-style-type: none"> - Set P302...P306 according to motor nameplate - Set P399 = 1 or 2 (if option 1 failed or in case of non-standard motor) - Make sure motor is cold (20° - 25° C) and apply a Start command - Display will indicate CAL for about 40 seconds - Once the calibration is complete, the display will indicate StoP; apply another Start command to actually start the motor - If an attempt is made to start the drive in Vector or Enhanced V/Hz mode before performing the Motor Calibration, the drive will display F_n Id and will not operate P300 = 2, 3: Same as above but only need to set P302...P304 		
P302 ⁽¹⁾	Motor Rated Voltage	0	{V}	600	<ul style="list-style-type: none"> • Default setting = drive rating • Set to motor nameplate data
P303 ⁽¹⁾	Motor Rated Current	0.1	{A}	500.0	

(1) Any changes to this parameter will not take effect until the drive is stopped.



Commissioning

Code		Possible Settings				IMPORTANT
No.	Name	Default	Selection			
P304 ⁽¹⁾	Motor Rated Frequency	60	0	{Hz}	1000	Set to motor nameplate data
P305 ⁽¹⁾	Motor Rated Speed	1750	300	{RPM}	65000	
P306 ⁽¹⁾	Motor Cosine Phi	0.80	0.40		0.99	
			NOTE If motor cosine phi is not known, use one of the following formulas: $\cos \phi = \text{motor Watts} / (\text{motor efficiency} \times P302 \times P303 \times 1.732)$ $\cos \phi = \cos [\sin^{-1} (\text{magnetizing current} / \text{motor current})]$			
P310 ⁽¹⁾	Motor Stator Resistance		0.00	{Ω}	64.00	<ul style="list-style-type: none"> P310, 311 default setting depends on drive rating Will be automatically programmed by P399 Changing these settings can adversely affect performance. Contact factory technical support prior to changing
P311 ⁽¹⁾	Motor Stator Inductance		0.0	{mH}	2000	
P315	Dead Time Compensation Factor	0.0	-50.0	{%}	+50.0	<ul style="list-style-type: none"> Adjust dead time correction from internal default Takes effect when P399 = 3.
P330	Torque Limit	100	0	{%}	400	When P300 = 5, sets the maximum output torque.
P331	Preset Torque Setpoint #1	100	0	{%}	400	TB-13A activated; P121 = 3 and P300 = 5
P332	Preset Torque Setpoint #2	100	0	{%}	400	TB-13B activated; P122 = 3 and P300 = 5
P333	Preset Torque Setpoint #3	100	0	{%}	400	TB-13C activated; P123 = 3 and P300 = 5
P334 ⁽²⁾	Preset Torque Setpoint #4	100	0	{%}	400	TB-13D activated; P124 = 3 and P300 = 5
P340 ⁽¹⁾	Current Loop P Gain	0.25	0.00		16.0	Changing these settings can adversely affect performance. Contact factory technical support prior to changing.
P341 ⁽¹⁾	Current Loop I Gain	65	12	{ms}	9990	
P342 ⁽¹⁾	Speed Loop Adjust	0.0	0.0	{%}	20.0	
P343	Slip Compensation Response Filter	99	90	{ms}	9999	Low pass filter time constant for varying the slip compensation response to changes in the motor current.
P399	Motor Auto-calibration	0	0	Calibration Not Done		<ul style="list-style-type: none"> If P300 = 4 or 5, motor calibration must be performed if P399 is not set to 3 (bypass calibration). If P300=2 or 3, motor calibration is recommended. Use option 2 if option 1 failed or in case of non-standard motors An alternating CAL / Err will occur if: <ul style="list-style-type: none"> - attempt motor calibration with P300 = 0 or 1 - motor calibration is attempted before programming motor data
			1	Standard Calibration Enabled		
			2	Advanced Calibration Enabled		
			3	Bypass Calibration, enable operation in vector mode w/o Auto Calibration		
			4	Standard Calibration Complete		
			5	Advanced Calibration Complete		
			NOTE: To run the Auto Calibration: <ul style="list-style-type: none"> - Set P302...P306 according to motor nameplate - Set P399 = 1 or 2 (if option 1 failed or in case of non-standard motor) - Make sure motor is cold (20° - 25° C) - Apply a Start command - Display will indicate CAL for about 40 seconds - Once the calibration is complete, the display will indicate Stop; apply another Start command to actually start the motor - Parameter P399 will now be set to 4 or 5. 			

(1) Any changes to this parameter will not take effect until the drive is stopped.

(2) Parameter applicable to SMV models 15HP (11kW) and higher.



4.5.6 Network Parameters

Code		Possible Settings		IMPORTANT
No.	Name	Default	Selection	
P400	Network Protocol		0 Not Active 1 Remote Keypad 2 Modbus RTU 3 CANopen 4 DeviceNet 5 Ethernet 6 Profibus 7 Lecom-B 8 I/O Module	This parameter setting is based upon the network or I/O module that is installed.
P401	Module Type Installed	0	0 No Module Installed 1 Basic I/O (0x0100, 1.0.0) 2 RS485/Rem. Keypad (0x0200, 2.0.0) 3 CANopen (0x0300, 3.0.0) 11 PROFIBUS (0x1100, 11.0.0) 12 Ethernet (0x1200, 12.0.0)	Module type format: 0xAABC; Drive Display: AA.B.C AA = Module Type B = Major revision C = minor revision
P402	Module Status	0	0 Not Initialized 1 Initialization: Module to EPM 2 Initialization: EPM to Module 3 Online 4 Failed Initialization Error 5 Time-out Error 6 Initialization Failed 7 Initialization Error	Module type mismatch P401 Protocol selection mismatch P400
P403	Module Reset	0	0 No Action 1 Reset parameters to default values	Returns module parameters 401...499 to the default values shown in the manual
P404	Module Timeout Action	3	0 No Fault 1 STOP (see P111) 2 Quick Stop 3 Fault (F_ntF)	Action to be taken in the event of a Module/ Drive Time-out. Time is fixed at 200ms STOP is by the method selected in P111.
P405	Current Network Fault		0 No Fault 1 F.nF1 2 F.nF2 3 F.nF3 4 F.nF4 5 F.nF5 6 F.nF6 7 F.nF7	Netidle Mode Loss of Ethernet I/O connection Network Fault Explicit Message Timeout Overall Network Timeout Overall Explicit Timeout Overall I/O Message Timeout
P406	Proprietary			Manufacturer specific
P407 ... P499		Module Specific Parameters		Refer to the Communications Reference Guide specific to the network or I/O module installed.



Commissioning

4.5.7 Diagnostic Parameters

Code		Display Range (READ ONLY)		IMPORTANT
No.	Name			
P500	Fault History			<ul style="list-style-type: none"> Displays the last 8 faults Format: n.xxx where: n = 1..8, 1 is the newest fault; xxx = fault message (w/o the F.) Refer to section 5.3
P501	Software Version			Format: x.yz
P502	Drive ID			A flashing display indicates that the Drive ID stored in the EPM does not match the drive model it is plugged into.
P503	Internal Code			Alternating Display: xxx-; -yy
P505	DC Bus Voltage	0	{VDC} 1500	
P506	Motor Voltage	0	{VAC} 1000	
P507	Load	0	{%} 255	Motor load as % of drive's output current rating. Refer to section 2.3.
P508	Motor Current	0.0	{A} 1000	Actual motor current
P509	Torque	0	{%} 500	Torque as % of motor rated torque (vector mode only)
PS10	Output Power kW	0.00	{kW} 650.0	
PS11	Total kWh	0.0	{kWh} 9999999	Alternating display: xxx-; yyyy when value exceeds 9999
PS12	Heatsink Temp	0	{°C} 150	Heatsink temperature
P520	0-10 VDC Input	0.0	{VDC} 10.0	Actual value of signal at TB-5 (See P162)
P521	4-20 mA Input	0.0	{mA} 20.0	Actual value of signal at TB-25 (See P162)
P522	TB-5 Feedback	P204	P205	TB-5 signal value scaled to PID feedback units (See P162)
P523	TB-25 Feedback	P204	P205	TB-25 signal value scaled to PID feedback units (See P162)
P524	Network Feedback	P204	P205	Network signal value scaled to PID feedback units
P525	Analog Output	0	{VDC} 10.0	Refer to P150...P155
P527	Actual Output Frequency	0	{Hz} 500.0	
P528	Network Speed Command	0	{Hz} 500.0	Command speed if (Auto: Network) is selected as the speed source
P530	Terminal and Protection Status			Indicates terminal status using segments of the LED display. (Refer to section 4.5.7.1)
P531	Keypad Status			Indicates keypad button status using segments of the LED display. (Refer to section 4.5.7.2)
P540	Total Run Time	0	{h} 9999999	Alternating display: xxx-; yyyy when value exceeds 9999
P541	Total Power On Time	0	{h} 9999999	
P550	Fault History	1	8	<ul style="list-style-type: none"> Displays the last 8 faults Format: n.xxx where: n = 1..8, 1 is the newest fault; xxx = fault message (w/o the F.) Refer to section 5.3
P551	Fault History Time	0	{h} 9999999	Display: "n.hh-" "hhhh" "mm.ss" = fault #, hours, seconds The "hhhh" screen is displayed after hours exceed 999.
P552	Fault History Counter	0	255	Number of sequential occurrences of a fault. For example: 3 external faults occur over a period of time with no other errors occurring. Then P552 will indicate 3, P550 will indicate the error EF and P551 will indicate the time of the first fault occurrence.



Code		Display Range (READ ONLY)		IMPORTANT
No.	Name			
P560	Sequencer: Currently Active Segment	0	17	
P561	Sequencer: Time since Start of Active Segment	0.0 0	{P708} {P708} 6553.5 65535	Unit depends on P708 (0.1sec, sec or minutes)
P562	Sequencer: Time Remaining in Active Segment	0.0 0	{P708} {P708} 6553.5 65535	Unit depends on P708 (0.1sec, sec or minutes)
P563	Sequencer: Number of cycles since start	0	65535	
P564	Sequencer: Number of cycles remaining	0	65535	
		NOTE: Parameters P560-P564 are visible only when P700 > 0 (i.e. the sequencer is enabled)		

4.5.7.1 Terminal & Protection Status Display

Parameter P530 allows monitoring of the control terminal points and common drive conditions:

An illuminated LED segment indicates:

- the protective circuit is active (LED 1)
- the Logic Assertion Switch is set to High (+)
- input terminal is asserted (LED 2)
- output terminal is energized (LED 4)
- the Charge Relay is not a terminal, this segment will be illuminated when the Charge Relay is energized (LED 4).

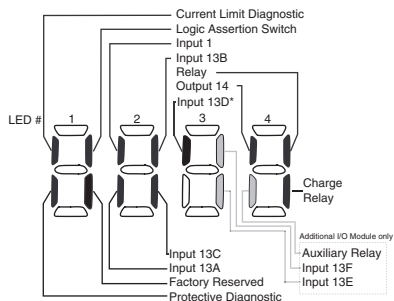

* Input 13D available on 15-60HP (11-45kW) models only

4.5.7.2 Keypad Status Display

Parameter P531 allows monitoring of the keypad pushbuttons:

An illuminated LED segment indicates when the button is depressed.

LED 1 and LED 2 are used to indicate pushbutton presses on a remote keypad that is attached to the drive. LED 3 and LED 4 indicate button presses on the local drive keypad.

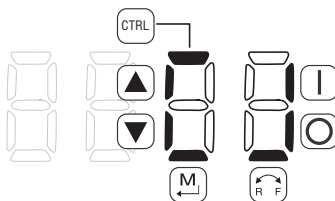



Commissioning

4.5.8 Onboard Communications Parameters 15-60HP (11-45kW)

The P6xx Onboard Communication parameters are applicable to the 15HP (11kW) and higher models only.

Code		Possible Settings		IMPORTANT
No.	Name	Default	Selection	
P600	Network Enable	0	0 Disabled 1 Remote Keypad 2 Modbus 7 Lecom	This parameter enables the onboard network communications. If the onboard communications are disabled, the user will not have access to any of the other P6xx parameters.
			NOTE: Onboard Communications will be disabled if: - P600 = 0, or - P600 = 1 and P400 = 1, or - P600 = 2 and P400 = 2, 3, 4, 5, 6 or 7 - P600 = 7 and P400 = 2, 3, 4, 5, 6 or 7	
P610	Network Address	1	1 - 247	Modbus
		1	1 - 99	Lecom
P611	Network Baud Rate	2	0 2400 bps 2 9600 bps 1 4800 bps 3 19200 bps	Modbus
		0	0 9600 bps 1 4800 bps 2 2400 bps 3 1200 bps 4 19200 bps	Lecom
P612	Network Data Format	0	0 8, N, 2 1 8, N, 1 2 8, E, 1 3 8, O, 1	Modbus Only
P620	Network Control Level	0	0 Monitor Only 1 Parameter Programming 2 Programming and Setpoint Control 3 Full Control	Lecom Only
P624	Network Powerup Start Status	0	0 Quick Stop 1 Controller Inhibit	Lecom Only
P625	Network Timeout	10.0	0.0 - 300.0 seconds	Modbus
		50	0 - 65000 milliseconds	Lecom
P626	Network Timeout Action	4	0 No action 1 Stop (P111) 2 Quick Stop 3 Controller Inhibit 4 Trip Fault, F.nF1	Modbus
		0	0 No action 1 Controller Inhibit 2 Quick Stop 3 Trip Fault, F.nF1	Lecom
P627	Network Messages Received		Read-Only: 0 - 9999 NOTE: When the number of messages exceeds 9999, the counter resets and resumes counting from 0.	Valid network messages received



4.5.9 Sequencer Parameters

The P700 Sequencer parameters are listed herein. Refer to section 4.5.7 for P56x Sequencer Diagnostic Parameters. The sequencer function consists of 16 step segments, each individual step segment can have its own ramp time, time spent in individual segment and output frequency entered. The sequencer has 3 different modes to control how the drive moves through each individual step segment: Timer Transition, Step Sequence or Timer and Step Sequence.

P700= 1 (Timer Transition)

Starting at the segment number entered in the "Start Segment" parameter, the drive will automatically move through each of the segments. The time spent in each segment is determined by the values set in the individual "Time in Current Step" parameters.

P700= 2 (Step Sequence)

Starting at the segment number entered in the "Start Segment" parameter the sequencer will only move to the next segment when a rising edge is applied to the highest priority digital input which is programmed to "Step Sequence" selection "24".

P700= 3 (Timer Transition or Step Sequence)

Starting at the segment number entered in the "Start Segment" parameter, the drive will automatically move through each of the segments. The time spent in each segment is determined by the values set in the individual "Time in Current Step" parameters, however if a rising edge is applied to the highest priority digital input which is programmed to "Step Sequence" selection "24" it will force the sequencer to step into the next segment.

NOTE: A value of "0" in the "Time in current step" parameter (ex: P712), will result in the segment being skipped.

Code		Possible Settings		IMPORTANT
No.	Name	Default	Selection	
P700	Sequencer Mode	0	0 Disabled 1 Enabled: transition on timer only 2 Enabled: transition on rising edge (P121, 122, 123 = 25 step sequence) 3 Enabled: transition on timer or rising edge	If P700 = 0 and no reference (P121, P101) points to any of the sequence segments, then P701-P799 will not be displayed on the local keypad.
P701	Sequencer: TB13A Trigger Segment	1	1 - 16 TB13A = lowest priority	Asserting TB13A with selection #24 (Start Sequence), starts the sequence operation from the segment specified in this parameter.
P702	Sequencer: TB13B Trigger Segment	1	1 - 16 TB13B: higher priority than TB13A	Asserting TB13B with selection #24 (Start Sequence), starts the sequence operation from the segment specified in this parameter.
P703	Sequencer: TB13C Trigger Segment	1	1 - 16 TB13C: higher priority than TB13B, A	Asserting TB13C with selection #24 (Start Sequence), starts the sequence operation from the segment specified in this parameter.
P704 ⁽²⁾	Sequencer: TB13D Trigger Segment	1	1 - 16 TB13D: higher priority than TB13C, B, A	Asserting TB13D with selection #24 (Start Sequence), starts the sequence operation from the segment specified in this parameter.
P706	Sequencer: Action after Stop/Start transition or Fault Restart	0	0 Restart at beginning of sequence 1 Restart at beginning of current seg 2 Start at beginning of prior segment 3 Start at beginning of next segment	Pointed by TB13x
P707	Sequencer: Number of cycles	1	1 65535	1 = single scan; 65535 = continuous loop

(2) Parameter applicable to SMV models 15HP (11kW) and higher.



Commissioning

Code		Possible Settings				IMPORTANT																																				
No.	Name	Default	Selection																																							
P708	Sequencer: Time units/scaling	0	0	0.1	{sec}	6553.5	Setup units/scaling for all sequencer time related parameters																																			
			1	1	{sec}	65535																																				
			2	1	{min}	65535																																				
			NOTE: P708 rescales the following sequencer related parameters: - Segment Times in current step: P712, P717, P722, P727, P732, P737, P742, P747, P752, P757, P762, P767, P772, P777, P782, P787, P792 - Sequence diagnostic/status: P561, P562																																							
Segment #1																																										
P710	Segment #1 Frequency Setpoint	0.0	-500.0	{Hz}	500.0	If P112 = 1, negative sign forces reverse direction																																				
P711	Segment #1 Accel/Decel Time	20.0	0.0	{sec}	3600.0																																					
P712	Segment #1 Time in current step	0.0 0	0.0 0	{P708}	6553.5 65535	Scaling/units depend on P708 Skip segment if time = 0																																				
P713	Segment #1 Digital Output State	0	<table border="1"> <thead> <tr> <th>Value set in P713</th> <th>0</th> <th>1</th> <th>2</th> <th>3</th> <th>4</th> <th>5</th> <th>6</th> <th>7</th> </tr> </thead> <tbody> <tr> <td>Relay (Bit 0)</td> <td>0</td> <td>1</td> <td>0</td> <td>1</td> <td>0</td> <td>1</td> <td>0</td> <td>1</td> </tr> <tr> <td>TB14 (Bit 1)</td> <td>0</td> <td>0</td> <td>1</td> <td>1</td> <td>0</td> <td>0</td> <td>1</td> <td>1</td> </tr> <tr> <td>I/O option Relay (Bit 2)</td> <td>0</td> <td>0</td> <td>0</td> <td>0</td> <td>1</td> <td>1</td> <td>1</td> <td>1</td> </tr> </tbody> </table>			Value set in P713	0	1	2	3	4	5	6	7	Relay (Bit 0)	0	1	0	1	0	1	0	1	TB14 (Bit 1)	0	0	1	1	0	0	1	1	I/O option Relay (Bit 2)	0	0	0	0	1	1	1	1	bit = 0: OFF (De-energized) bit = 1: ON (Energized) The corresponding digital output/relay must be set to accept data from the sequencer: P140, P142, P441 = 27
Value set in P713	0	1	2	3	4	5	6	7																																		
Relay (Bit 0)	0	1	0	1	0	1	0	1																																		
TB14 (Bit 1)	0	0	1	1	0	0	1	1																																		
I/O option Relay (Bit 2)	0	0	0	0	1	1	1	1																																		
P714	Segment #1 TB30 Analog Output Value	0.00	0.00	{VDC}	10.00	TB30 configuration parameter must be set to accept this value: P150 = 10																																				
Segment #2																																										
P715	Segment #2 Frequency Setpoint	0.0	-500.0	{Hz}	500.0	If P112 = 1, negative sign forces reverse direction																																				
P716	Segment #2 Accel/Decel Time	20.0	0.0	{sec}	3600.0																																					
P717	Segment #2 Time in current step	0.0 0	0.0 0	{P708}	6553.5 65535	Scaling/units depend on P708 Skip segment if time = 0																																				
P718	Segment #2 Digital Output State	0	<table border="1"> <thead> <tr> <th>Value set in P718</th> <th>0</th> <th>1</th> <th>2</th> <th>3</th> <th>4</th> <th>5</th> <th>6</th> <th>7</th> </tr> </thead> <tbody> <tr> <td>Relay (Bit 0)</td> <td>0</td> <td>1</td> <td>0</td> <td>1</td> <td>0</td> <td>1</td> <td>0</td> <td>1</td> </tr> <tr> <td>TB14 (Bit 1)</td> <td>0</td> <td>0</td> <td>1</td> <td>1</td> <td>0</td> <td>0</td> <td>1</td> <td>1</td> </tr> <tr> <td>I/O option Relay (Bit 2)</td> <td>0</td> <td>0</td> <td>0</td> <td>0</td> <td>1</td> <td>1</td> <td>1</td> <td>1</td> </tr> </tbody> </table>			Value set in P718	0	1	2	3	4	5	6	7	Relay (Bit 0)	0	1	0	1	0	1	0	1	TB14 (Bit 1)	0	0	1	1	0	0	1	1	I/O option Relay (Bit 2)	0	0	0	0	1	1	1	1	bit = 0: OFF (De-energized) bit = 1: ON (Energized) The corresponding digital output/relay must be set to accept data from the sequencer: P140, P142, P441 = 27
Value set in P718	0	1	2	3	4	5	6	7																																		
Relay (Bit 0)	0	1	0	1	0	1	0	1																																		
TB14 (Bit 1)	0	0	1	1	0	0	1	1																																		
I/O option Relay (Bit 2)	0	0	0	0	1	1	1	1																																		
P719	Segment #2 TB30 Analog Output Value	0.00	0.00	{VDC}	10.00	TB30 configuration parameter must be set to accept this value: P150 = 10																																				

Commissioning



Code		Possible Settings				IMPORTANT																																				
No.	Name	Default	Selection																																							
Segment #3																																										
P120	Segment #3 Frequency Setpoint	0.0	-500.0	{Hz}	500.0	If P112 = 1, negative sign forces reverse direction																																				
P121	Segment #3 Accel/Decel Time	20.0	0.0	{sec}	3600.0																																					
P122	Segment #3 Time in current step	0.0 0	0.0 0	{P708} {P708}	6553.5 65535	Scaling/units depend on P708 Skip segment if time = 0																																				
P123	Segment #3 Digital Output State	0	<table border="1"> <thead> <tr> <th>Value set in P723</th> <th>0</th> <th>1</th> <th>2</th> <th>3</th> <th>4</th> <th>5</th> <th>6</th> <th>7</th> </tr> </thead> <tbody> <tr> <td>Relay (Bit 0)</td> <td>0</td> <td>1</td> <td>0</td> <td>1</td> <td>0</td> <td>1</td> <td>0</td> <td>1</td> </tr> <tr> <td>TB14 (Bit 1)</td> <td>0</td> <td>0</td> <td>1</td> <td>1</td> <td>0</td> <td>0</td> <td>1</td> <td>1</td> </tr> <tr> <td>I/O option Relay (Bit 2)</td> <td>0</td> <td>0</td> <td>0</td> <td>0</td> <td>1</td> <td>1</td> <td>1</td> <td>1</td> </tr> </tbody> </table>			Value set in P723	0	1	2	3	4	5	6	7	Relay (Bit 0)	0	1	0	1	0	1	0	1	TB14 (Bit 1)	0	0	1	1	0	0	1	1	I/O option Relay (Bit 2)	0	0	0	0	1	1	1	1	bit = 0: OFF (De-energized) bit = 1: ON (Energized) The corresponding digital output/relay must be set to accept data from the sequencer: P140, P142, P441 = 27
Value set in P723	0	1	2	3	4	5	6	7																																		
Relay (Bit 0)	0	1	0	1	0	1	0	1																																		
TB14 (Bit 1)	0	0	1	1	0	0	1	1																																		
I/O option Relay (Bit 2)	0	0	0	0	1	1	1	1																																		
P124	Segment #3 TB30 Analog Output Value	0.00	0.00	{VDC}	10.00	TB30 configuration parameter must be set to accept this value: P150 = 10																																				
Segment #4																																										
P125	Segment #4 Frequency Setpoint	0.0	-500.0	{Hz}	500.0	If P112 = 1, negative sign forces reverse direction																																				
P126	Segment #4 Accel/Decel Time	20.0	0.0	{sec}	3600.0																																					
P127	Segment #4 Time in current step	0.0 0	0.0 0	{P708} {P708}	6553.5 65535	Scaling/units depend on P708 Skip segment if time = 0																																				
P128	Segment #4 Digital Output State	0	<table border="1"> <thead> <tr> <th>Value set in P728</th> <th>0</th> <th>1</th> <th>2</th> <th>3</th> <th>4</th> <th>5</th> <th>6</th> <th>7</th> </tr> </thead> <tbody> <tr> <td>Relay (Bit 0)</td> <td>0</td> <td>1</td> <td>0</td> <td>1</td> <td>0</td> <td>1</td> <td>0</td> <td>1</td> </tr> <tr> <td>TB14 (Bit 1)</td> <td>0</td> <td>0</td> <td>1</td> <td>1</td> <td>0</td> <td>0</td> <td>1</td> <td>1</td> </tr> <tr> <td>I/O option Relay (Bit 2)</td> <td>0</td> <td>0</td> <td>0</td> <td>0</td> <td>1</td> <td>1</td> <td>1</td> <td>1</td> </tr> </tbody> </table>			Value set in P728	0	1	2	3	4	5	6	7	Relay (Bit 0)	0	1	0	1	0	1	0	1	TB14 (Bit 1)	0	0	1	1	0	0	1	1	I/O option Relay (Bit 2)	0	0	0	0	1	1	1	1	bit = 0: OFF (De-energized) bit = 1: ON (Energized) The corresponding digital output/relay must be set to accept data from the sequencer: P140, P142, P441 = 27
Value set in P728	0	1	2	3	4	5	6	7																																		
Relay (Bit 0)	0	1	0	1	0	1	0	1																																		
TB14 (Bit 1)	0	0	1	1	0	0	1	1																																		
I/O option Relay (Bit 2)	0	0	0	0	1	1	1	1																																		
P129	Segment #4 TB30 Analog Output Value	0.00	0.00	{VDC}	10.00	TB30 configuration parameter must be set to accept this value: P150 = 10																																				
Segment #5																																										
P130	Segment #5 Frequency Setpoint	0.0	-500.0	{Hz}	500.0	If P112 = 1, negative sign forces reverse direction																																				
P131	Segment #5 Accel/Decel Time	20.0	0.0	{sec}	3600.0																																					
P132	Segment #5 Time in current step	0.0 0	0.0 0	{P708} {P708}	6553.5 65535	Scaling/units depend on P708 Skip segment if time = 0																																				
P133	Segment #5 Digital Output State	0	<table border="1"> <thead> <tr> <th>Value set in P733</th> <th>0</th> <th>1</th> <th>2</th> <th>3</th> <th>4</th> <th>5</th> <th>6</th> <th>7</th> </tr> </thead> <tbody> <tr> <td>Relay (Bit 0)</td> <td>0</td> <td>1</td> <td>0</td> <td>1</td> <td>0</td> <td>1</td> <td>0</td> <td>1</td> </tr> <tr> <td>TB14 (Bit 1)</td> <td>0</td> <td>0</td> <td>1</td> <td>1</td> <td>0</td> <td>0</td> <td>1</td> <td>1</td> </tr> <tr> <td>I/O option Relay (Bit 2)</td> <td>0</td> <td>0</td> <td>0</td> <td>0</td> <td>1</td> <td>1</td> <td>1</td> <td>1</td> </tr> </tbody> </table>			Value set in P733	0	1	2	3	4	5	6	7	Relay (Bit 0)	0	1	0	1	0	1	0	1	TB14 (Bit 1)	0	0	1	1	0	0	1	1	I/O option Relay (Bit 2)	0	0	0	0	1	1	1	1	bit = 0: OFF (De-energized) bit = 1: ON (Energized) The corresponding digital output/relay must be set to accept data from the sequencer: P140, P142, P441 = 27
Value set in P733	0	1	2	3	4	5	6	7																																		
Relay (Bit 0)	0	1	0	1	0	1	0	1																																		
TB14 (Bit 1)	0	0	1	1	0	0	1	1																																		
I/O option Relay (Bit 2)	0	0	0	0	1	1	1	1																																		
P134	Segment #5 TB30 Analog Output Value	0.00	0.00	{VDC}	10.00	TB30 configuration parameter must be set to accept this value: P150 = 10																																				



Commissioning

Code		Possible Settings				IMPORTANT																																				
No.	Name	Default	Selection																																							
Segment #6																																										
P735	Segment #6 Frequency Setpoint	0.0	-500.0	{Hz}	500.0	If P112 = 1, negative sign forces reverse direction																																				
P736	Segment #6 Accel/Decel Time	20.0	0.0	{sec}	3600.0																																					
P737	Segment #6 Time in current step	0.0 0	0.0 0	{P708} {P708}	6553.5 65535	Scaling/units depend on P708 Skip segment if time = 0																																				
P738	Segment #6 Digital Output State	0	<table border="1"> <thead> <tr> <th>Value set in P738</th> <th>0</th> <th>1</th> <th>2</th> <th>3</th> <th>4</th> <th>5</th> <th>6</th> <th>7</th> </tr> </thead> <tbody> <tr> <td>Relay (Bit 0)</td> <td>0</td> <td>1</td> <td>0</td> <td>1</td> <td>0</td> <td>1</td> <td>0</td> <td>1</td> </tr> <tr> <td>TB14 (Bit 1)</td> <td>0</td> <td>0</td> <td>1</td> <td>1</td> <td>0</td> <td>0</td> <td>1</td> <td>1</td> </tr> <tr> <td>I/O option Relay (Bit 2)</td> <td>0</td> <td>0</td> <td>0</td> <td>0</td> <td>1</td> <td>1</td> <td>1</td> <td>1</td> </tr> </tbody> </table>			Value set in P738	0	1	2	3	4	5	6	7	Relay (Bit 0)	0	1	0	1	0	1	0	1	TB14 (Bit 1)	0	0	1	1	0	0	1	1	I/O option Relay (Bit 2)	0	0	0	0	1	1	1	1	bit = 0: OFF (De-energized) bit = 1: ON (Energized) The corresponding digital output/relay must be set to accept data from the sequencer: P140, P142, P441 = 27
Value set in P738	0	1	2	3	4	5	6	7																																		
Relay (Bit 0)	0	1	0	1	0	1	0	1																																		
TB14 (Bit 1)	0	0	1	1	0	0	1	1																																		
I/O option Relay (Bit 2)	0	0	0	0	1	1	1	1																																		
P739	Segment #6 TB30 Analog Output Value	0.00	0.00	{VDC}	10.00	TB30 configuration parameter must be set to accept this value: P150 = 10																																				
Segment #7																																										
P740	Segment #7 Frequency Setpoint	0.0	-500.0	{Hz}	500.0	If P112 = 1, negative sign forces reverse direction																																				
P741	Segment #7 Accel/Decel Time	20.0	0.0	{sec}	3600.0																																					
P742	Segment #7 Time in current step	0.0 0	0.0 0	{P708} {P708}	6553.5 65535	Scaling/units depend on P708 Skip segment if time = 0																																				
P743	Segment #7 Digital Output State	0	<table border="1"> <thead> <tr> <th>Value set in P743</th> <th>0</th> <th>1</th> <th>2</th> <th>3</th> <th>4</th> <th>5</th> <th>6</th> <th>7</th> </tr> </thead> <tbody> <tr> <td>Relay (Bit 0)</td> <td>0</td> <td>1</td> <td>0</td> <td>1</td> <td>0</td> <td>1</td> <td>0</td> <td>1</td> </tr> <tr> <td>TB14 (Bit 1)</td> <td>0</td> <td>0</td> <td>1</td> <td>1</td> <td>0</td> <td>0</td> <td>1</td> <td>1</td> </tr> <tr> <td>I/O option Relay (Bit 2)</td> <td>0</td> <td>0</td> <td>0</td> <td>0</td> <td>1</td> <td>1</td> <td>1</td> <td>1</td> </tr> </tbody> </table>			Value set in P743	0	1	2	3	4	5	6	7	Relay (Bit 0)	0	1	0	1	0	1	0	1	TB14 (Bit 1)	0	0	1	1	0	0	1	1	I/O option Relay (Bit 2)	0	0	0	0	1	1	1	1	bit = 0: OFF (De-energized) bit = 1: ON (Energized) The corresponding digital output/relay must be set to accept data from the sequencer: P140, P142, P441 = 27
Value set in P743	0	1	2	3	4	5	6	7																																		
Relay (Bit 0)	0	1	0	1	0	1	0	1																																		
TB14 (Bit 1)	0	0	1	1	0	0	1	1																																		
I/O option Relay (Bit 2)	0	0	0	0	1	1	1	1																																		
P744	Segment #7 TB30 Analog Output Value	0.00	0.00	{VDC}	10.00	TB30 configuration parameter must be set to accept this value: P150 = 10																																				
Segment #8																																										
P745	Segment #8 Frequency Setpoint	0.0	-500.0	{Hz}	500.0	If P112 = 1, negative sign forces reverse direction																																				
P746	Segment #8 Accel/Decel Time	20.0	0.0	{sec}	3600.0																																					
P747	Segment #8 Time in current step	0.0 0	0.0 0	{P708} {P708}	6553.5 65535	Scaling/units depend on P708 Skip segment if time = 0																																				
P748	Segment #8 Digital Output State	0	<table border="1"> <thead> <tr> <th>Value set in P748</th> <th>0</th> <th>1</th> <th>2</th> <th>3</th> <th>4</th> <th>5</th> <th>6</th> <th>7</th> </tr> </thead> <tbody> <tr> <td>Relay (Bit 0)</td> <td>0</td> <td>1</td> <td>0</td> <td>1</td> <td>0</td> <td>1</td> <td>0</td> <td>1</td> </tr> <tr> <td>TB14 (Bit 1)</td> <td>0</td> <td>0</td> <td>1</td> <td>1</td> <td>0</td> <td>0</td> <td>1</td> <td>1</td> </tr> <tr> <td>I/O option Relay (Bit 2)</td> <td>0</td> <td>0</td> <td>0</td> <td>0</td> <td>1</td> <td>1</td> <td>1</td> <td>1</td> </tr> </tbody> </table>			Value set in P748	0	1	2	3	4	5	6	7	Relay (Bit 0)	0	1	0	1	0	1	0	1	TB14 (Bit 1)	0	0	1	1	0	0	1	1	I/O option Relay (Bit 2)	0	0	0	0	1	1	1	1	bit = 0: OFF (De-energized) bit = 1: ON (Energized) The corresponding digital output/relay must be set to accept data from the sequencer: P140, P142, P441 = 27
Value set in P748	0	1	2	3	4	5	6	7																																		
Relay (Bit 0)	0	1	0	1	0	1	0	1																																		
TB14 (Bit 1)	0	0	1	1	0	0	1	1																																		
I/O option Relay (Bit 2)	0	0	0	0	1	1	1	1																																		
P749	Segment #8 TB30 Analog Output Value	0.00	0.00	{VDC}	10.00	TB30 configuration parameter must be set to accept this value: P150 = 10																																				

Commissioning



Code		Possible Settings				IMPORTANT																																				
No.	Name	Default	Selection																																							
Segment #9																																										
P750	Segment #9 Frequency Setpoint	0.0	-500.0	{Hz}	500.0	If P112 = 1, negative sign forces reverse direction																																				
P751	Segment #9 Accel/Decel Time	20.0	0.0	{sec}	3600.0																																					
P752	Segment #9 Time in current step	0.0 0	0.0 0	{P708} {P708}	6553.5 65535	Scaling/units depend on P708 Skip segment if time = 0																																				
P753	Segment #9 Digital Output State	0	<table border="1"> <thead> <tr> <th>Value set in P753</th> <th>0</th> <th>1</th> <th>2</th> <th>3</th> <th>4</th> <th>5</th> <th>6</th> <th>7</th> </tr> </thead> <tbody> <tr> <td>Relay (Bit 0)</td> <td>0</td> <td>1</td> <td>0</td> <td>1</td> <td>0</td> <td>1</td> <td>0</td> <td>1</td> </tr> <tr> <td>TB14 (Bit 1)</td> <td>0</td> <td>0</td> <td>1</td> <td>1</td> <td>0</td> <td>0</td> <td>1</td> <td>1</td> </tr> <tr> <td>I/O option Relay (Bit 2)</td> <td>0</td> <td>0</td> <td>0</td> <td>0</td> <td>1</td> <td>1</td> <td>1</td> <td>1</td> </tr> </tbody> </table>			Value set in P753	0	1	2	3	4	5	6	7	Relay (Bit 0)	0	1	0	1	0	1	0	1	TB14 (Bit 1)	0	0	1	1	0	0	1	1	I/O option Relay (Bit 2)	0	0	0	0	1	1	1	1	bit = 0: OFF (De-energized) bit = 1: ON (Energized) The corresponding digital output/relay must be set to accept data from the sequencer: P140, P142, P441 = 27
Value set in P753	0	1	2	3	4	5	6	7																																		
Relay (Bit 0)	0	1	0	1	0	1	0	1																																		
TB14 (Bit 1)	0	0	1	1	0	0	1	1																																		
I/O option Relay (Bit 2)	0	0	0	0	1	1	1	1																																		
P754	Segment #9 TB30 Analog Output Value	0.00	0.00	{VDC}	10.00	TB30 configuration parameter must be set to accept this value: P150 = 10																																				
Segment #10																																										
P755	Segment #10 Frequency Setpoint	0.0	-500.0	{Hz}	500.0	If P112 = 1, negative sign forces reverse direction																																				
P756	Segment #10 Accel/Decel Time	20.0	0.0	{sec}	3600.0																																					
P757	Segment #10 Time in current step	0.0 0	0.0 0	{P708} {P708}	6553.5 65535	Scaling/units depend on P708 Skip segment if time = 0																																				
P758	Segment #10 Digital Output State	0	<table border="1"> <thead> <tr> <th>Value set in P758</th> <th>0</th> <th>1</th> <th>2</th> <th>3</th> <th>4</th> <th>5</th> <th>6</th> <th>7</th> </tr> </thead> <tbody> <tr> <td>Relay (Bit 0)</td> <td>0</td> <td>1</td> <td>0</td> <td>1</td> <td>0</td> <td>1</td> <td>0</td> <td>1</td> </tr> <tr> <td>TB14 (Bit 1)</td> <td>0</td> <td>0</td> <td>1</td> <td>1</td> <td>0</td> <td>0</td> <td>1</td> <td>1</td> </tr> <tr> <td>I/O option Relay (Bit 2)</td> <td>0</td> <td>0</td> <td>0</td> <td>0</td> <td>1</td> <td>1</td> <td>1</td> <td>1</td> </tr> </tbody> </table>			Value set in P758	0	1	2	3	4	5	6	7	Relay (Bit 0)	0	1	0	1	0	1	0	1	TB14 (Bit 1)	0	0	1	1	0	0	1	1	I/O option Relay (Bit 2)	0	0	0	0	1	1	1	1	bit = 0: OFF (De-energized) bit = 1: ON (Energized) The corresponding digital output/relay must be set to accept data from the sequencer: P140, P142, P441 = 27
Value set in P758	0	1	2	3	4	5	6	7																																		
Relay (Bit 0)	0	1	0	1	0	1	0	1																																		
TB14 (Bit 1)	0	0	1	1	0	0	1	1																																		
I/O option Relay (Bit 2)	0	0	0	0	1	1	1	1																																		
P759	Segment #10 TB30 Analog Output Value	0.00	0.00	{VDC}	10.00	TB30 configuration parameter must be set to accept this value: P150 = 10																																				
Segment #11																																										
P760	Segment #11 Frequency Setpoint	0.0	-500.0	{Hz}	500.0	If P112 = 1, negative sign forces reverse direction																																				
P761	Segment #11 Accel/Decel Time	20.0	0.0	{sec}	3600.0																																					
P762	Segment #11 Time in current step	0.0 0	0.0 0	{P708} {P708}	6553.5 65535	Scaling/units depend on P708 Skip segment if time = 0																																				
P763	Segment #11 Digital Output State	0	<table border="1"> <thead> <tr> <th>Value set in P763</th> <th>0</th> <th>1</th> <th>2</th> <th>3</th> <th>4</th> <th>5</th> <th>6</th> <th>7</th> </tr> </thead> <tbody> <tr> <td>Relay (Bit 0)</td> <td>0</td> <td>1</td> <td>0</td> <td>1</td> <td>0</td> <td>1</td> <td>0</td> <td>1</td> </tr> <tr> <td>TB14 (Bit 1)</td> <td>0</td> <td>0</td> <td>1</td> <td>1</td> <td>0</td> <td>0</td> <td>1</td> <td>1</td> </tr> <tr> <td>I/O option Relay (Bit 2)</td> <td>0</td> <td>0</td> <td>0</td> <td>0</td> <td>1</td> <td>1</td> <td>1</td> <td>1</td> </tr> </tbody> </table>			Value set in P763	0	1	2	3	4	5	6	7	Relay (Bit 0)	0	1	0	1	0	1	0	1	TB14 (Bit 1)	0	0	1	1	0	0	1	1	I/O option Relay (Bit 2)	0	0	0	0	1	1	1	1	bit = 0: OFF (De-energized) bit = 1: ON (Energized) The corresponding digital output/relay must be set to accept data from the sequencer: P140, P142, P441 = 27
Value set in P763	0	1	2	3	4	5	6	7																																		
Relay (Bit 0)	0	1	0	1	0	1	0	1																																		
TB14 (Bit 1)	0	0	1	1	0	0	1	1																																		
I/O option Relay (Bit 2)	0	0	0	0	1	1	1	1																																		
P764	Segment #11 TB30 Analog Output Value	0.00	0.00	{VDC}	10.00	TB30 configuration parameter must be set to accept this value: P150 = 10																																				



Commissioning

Code		Possible Settings				IMPORTANT																																				
No.	Name	Default	Selection																																							
Segment #12																																										
P165	Segment #12 Frequency Setpoint	0.0	-500.0	{Hz}	500.0	If P112 = 1, negative sign forces reverse direction																																				
P166	Segment #12 Accel/Decel Time	20.0	0.0	{sec}	3600.0																																					
P167	Segment #12 Time in current step	0.0 0	0.0 0	{P708} {P708}	6553.5 65535	Scaling/units depend on P708 Skip segment if time = 0																																				
P168	Segment #12 Digital Output State	0	<table border="1"> <thead> <tr> <th>Value set in P768</th> <th>0</th> <th>1</th> <th>2</th> <th>3</th> <th>4</th> <th>5</th> <th>6</th> <th>7</th> </tr> </thead> <tbody> <tr> <td>Relay (Bit 0)</td> <td>0</td> <td>1</td> <td>0</td> <td>1</td> <td>0</td> <td>1</td> <td>0</td> <td>1</td> </tr> <tr> <td>TB14 (Bit 1)</td> <td>0</td> <td>0</td> <td>1</td> <td>1</td> <td>0</td> <td>0</td> <td>1</td> <td>1</td> </tr> <tr> <td>I/O option Relay (Bit 2)</td> <td>0</td> <td>0</td> <td>0</td> <td>0</td> <td>1</td> <td>1</td> <td>1</td> <td>1</td> </tr> </tbody> </table>			Value set in P768	0	1	2	3	4	5	6	7	Relay (Bit 0)	0	1	0	1	0	1	0	1	TB14 (Bit 1)	0	0	1	1	0	0	1	1	I/O option Relay (Bit 2)	0	0	0	0	1	1	1	1	bit = 0: OFF (De-energized) bit = 1: ON (Energized) The corresponding digital output/relay must be set to accept data from the sequencer: P140, P142, P441 = 27
Value set in P768	0	1	2	3	4	5	6	7																																		
Relay (Bit 0)	0	1	0	1	0	1	0	1																																		
TB14 (Bit 1)	0	0	1	1	0	0	1	1																																		
I/O option Relay (Bit 2)	0	0	0	0	1	1	1	1																																		
P169	Segment #12 TB30 Analog Output Value	0.00	0.00	{VDC}	10.00	TB30 configuration parameter must be set to accept this value: P150 = 10																																				
Segment #13																																										
P170	Segment #13 Frequency Setpoint	0.0	-500.0	{Hz}	500.0	If P112 = 1, negative sign forces reverse direction																																				
P171	Segment #13 Accel/Decel Time	20.0	0.0	{sec}	3600.0																																					
P172	Segment #13 Time in current step	0.0 0	0.0 0	{P708} {P708}	6553.5 65535	Scaling/units depend on P708 Skip segment if time = 0																																				
P173	Segment #13 Digital Output State	0	<table border="1"> <thead> <tr> <th>Value set in P773</th> <th>0</th> <th>1</th> <th>2</th> <th>3</th> <th>4</th> <th>5</th> <th>6</th> <th>7</th> </tr> </thead> <tbody> <tr> <td>Relay (Bit 0)</td> <td>0</td> <td>1</td> <td>0</td> <td>1</td> <td>0</td> <td>1</td> <td>0</td> <td>1</td> </tr> <tr> <td>TB14 (Bit 1)</td> <td>0</td> <td>0</td> <td>1</td> <td>1</td> <td>0</td> <td>0</td> <td>1</td> <td>1</td> </tr> <tr> <td>I/O option Relay (Bit 2)</td> <td>0</td> <td>0</td> <td>0</td> <td>0</td> <td>1</td> <td>1</td> <td>1</td> <td>1</td> </tr> </tbody> </table>			Value set in P773	0	1	2	3	4	5	6	7	Relay (Bit 0)	0	1	0	1	0	1	0	1	TB14 (Bit 1)	0	0	1	1	0	0	1	1	I/O option Relay (Bit 2)	0	0	0	0	1	1	1	1	bit = 0: OFF (De-energized) bit = 1: ON (Energized) The corresponding digital output/relay must be set to accept data from the sequencer: P140, P142, P441 = 27
Value set in P773	0	1	2	3	4	5	6	7																																		
Relay (Bit 0)	0	1	0	1	0	1	0	1																																		
TB14 (Bit 1)	0	0	1	1	0	0	1	1																																		
I/O option Relay (Bit 2)	0	0	0	0	1	1	1	1																																		
P174	Segment #13 TB30 Analog Output Value	0.00	0.00	{VDC}	10.00	TB30 configuration parameter must be set to accept this value: P150 = 10																																				
Segment #14																																										
P175	Segment #14 Frequency Setpoint	0.0	-500.0	{Hz}	500.0	If P112 = 1, negative sign forces reverse direction																																				
P176	Segment #14 Accel/Decel Time	20.0	0.0	{sec}	3600.0																																					
P177	Segment #14 Time in current step	0.0 0	0.0 0	{P708} {P708}	6553.5 65535	Scaling/units depend on P708 Skip segment if time = 0																																				
P178	Segment #14 Digital Output State	0	<table border="1"> <thead> <tr> <th>Value set in P778</th> <th>0</th> <th>1</th> <th>2</th> <th>3</th> <th>4</th> <th>5</th> <th>6</th> <th>7</th> </tr> </thead> <tbody> <tr> <td>Relay (Bit 0)</td> <td>0</td> <td>1</td> <td>0</td> <td>1</td> <td>0</td> <td>1</td> <td>0</td> <td>1</td> </tr> <tr> <td>TB14 (Bit 1)</td> <td>0</td> <td>0</td> <td>1</td> <td>1</td> <td>0</td> <td>0</td> <td>1</td> <td>1</td> </tr> <tr> <td>I/O option Relay (Bit 2)</td> <td>0</td> <td>0</td> <td>0</td> <td>0</td> <td>1</td> <td>1</td> <td>1</td> <td>1</td> </tr> </tbody> </table>			Value set in P778	0	1	2	3	4	5	6	7	Relay (Bit 0)	0	1	0	1	0	1	0	1	TB14 (Bit 1)	0	0	1	1	0	0	1	1	I/O option Relay (Bit 2)	0	0	0	0	1	1	1	1	bit = 0: OFF (De-energized) bit = 1: ON (Energized) The corresponding digital output/relay must be set to accept data from the sequencer: P140, P142, P441 = 27
Value set in P778	0	1	2	3	4	5	6	7																																		
Relay (Bit 0)	0	1	0	1	0	1	0	1																																		
TB14 (Bit 1)	0	0	1	1	0	0	1	1																																		
I/O option Relay (Bit 2)	0	0	0	0	1	1	1	1																																		
P179	Segment #14 TB30 Analog Output Value	0.00	0.00	{VDC}	10.00	TB30 configuration parameter must be set to accept this value: P150 = 10																																				

Commissioning



Code		Possible Settings				IMPORTANT																																				
No.	Name	Default	Selection																																							
Segment #15																																										
P780	Segment #15 Frequency Setpoint	0.0	-500.0	{Hz}	500.0	If P112 = 1, negative sign forces reverse direction																																				
P781	Segment #15 Accel/Decel Time	20.0	0.0	{sec}	3600.0																																					
P782	Segment #15 Time in current step	0.0 0	0.0 0	{P708} {P708}	6553.5 65535	Scaling/units depend on P708 Skip segment if time = 0																																				
P783	Segment #15 Digital Output State	0	<table border="1"> <thead> <tr> <th>Value set in P783</th> <th>0</th> <th>1</th> <th>2</th> <th>3</th> <th>4</th> <th>5</th> <th>6</th> <th>7</th> </tr> </thead> <tbody> <tr> <td>Relay (Bit 0)</td> <td>0</td> <td>1</td> <td>0</td> <td>1</td> <td>0</td> <td>1</td> <td>0</td> <td>1</td> </tr> <tr> <td>TB14 (Bit 1)</td> <td>0</td> <td>0</td> <td>1</td> <td>1</td> <td>0</td> <td>0</td> <td>1</td> <td>1</td> </tr> <tr> <td>I/O option Relay (Bit 2)</td> <td>0</td> <td>0</td> <td>0</td> <td>0</td> <td>1</td> <td>1</td> <td>1</td> <td>1</td> </tr> </tbody> </table>			Value set in P783	0	1	2	3	4	5	6	7	Relay (Bit 0)	0	1	0	1	0	1	0	1	TB14 (Bit 1)	0	0	1	1	0	0	1	1	I/O option Relay (Bit 2)	0	0	0	0	1	1	1	1	bit = 0: OFF (De-energized) bit = 1: ON (Energized) The corresponding digital output/relay must be set to accept data from the sequencer: P140, P142, P441 = 27
Value set in P783	0	1	2	3	4	5	6	7																																		
Relay (Bit 0)	0	1	0	1	0	1	0	1																																		
TB14 (Bit 1)	0	0	1	1	0	0	1	1																																		
I/O option Relay (Bit 2)	0	0	0	0	1	1	1	1																																		
P784	Segment #15 TB30 Analog Output Value	0.00	0.00	{VDC}	10.00	TB30 configuration parameter must be set to accept this value: P150 = 10																																				
Segment #16																																										
P785	Segment #16 Frequency Setpoint	0.0	-500.0	{Hz}	500.0	If P112 = 1, negative sign forces reverse direction																																				
P786	Segment #16 Accel/Decel Time	20.0	0.0	{sec}	3600.0																																					
P787	Segment #16 Time in current step	0.0 0	0.0 0	{P708} {P708}	6553.5 65535	Scaling/units depend on P708 Skip segment if time = 0																																				
P788	Segment #16 Digital Output State	0	<table border="1"> <thead> <tr> <th>Value set in P788</th> <th>0</th> <th>1</th> <th>2</th> <th>3</th> <th>4</th> <th>5</th> <th>6</th> <th>7</th> </tr> </thead> <tbody> <tr> <td>Relay (Bit 0)</td> <td>0</td> <td>1</td> <td>0</td> <td>1</td> <td>0</td> <td>1</td> <td>0</td> <td>1</td> </tr> <tr> <td>TB14 (Bit 1)</td> <td>0</td> <td>0</td> <td>1</td> <td>1</td> <td>0</td> <td>0</td> <td>1</td> <td>1</td> </tr> <tr> <td>I/O option Relay (Bit 2)</td> <td>0</td> <td>0</td> <td>0</td> <td>0</td> <td>1</td> <td>1</td> <td>1</td> <td>1</td> </tr> </tbody> </table>			Value set in P788	0	1	2	3	4	5	6	7	Relay (Bit 0)	0	1	0	1	0	1	0	1	TB14 (Bit 1)	0	0	1	1	0	0	1	1	I/O option Relay (Bit 2)	0	0	0	0	1	1	1	1	bit = 0: OFF (De-energized) bit = 1: ON (Energized) The corresponding digital output/relay must be set to accept data from the sequencer: P140, P142, P441 = 27
Value set in P788	0	1	2	3	4	5	6	7																																		
Relay (Bit 0)	0	1	0	1	0	1	0	1																																		
TB14 (Bit 1)	0	0	1	1	0	0	1	1																																		
I/O option Relay (Bit 2)	0	0	0	0	1	1	1	1																																		
P789	Segment #16 TB30 Analog Output Value	0.00	0.00	{VDC}	10.00	TB30 configuration parameter must be set to accept this value: P150 = 10																																				
End Segment																																										
P790	End Segment: Frequency Setpoint	0.0	-500.0	{Hz}	500.0	If P112 = 1, negative sign forces reverse direction																																				
P791	End Segment: Accel/Decel Time	5.0	0.0	{sec}	3600.0																																					
P792	End Segment: Delay before P793, 794 & 795 activation	0.0 0	0.0 0	{P708} {P708}	6553.5 65535	Scaling/units depend on P708																																				
P793	End Segment: Digital Output State		<table border="1"> <thead> <tr> <th>Value set in P793</th> <th>0</th> <th>1</th> <th>2</th> <th>3</th> <th>4</th> <th>5</th> <th>6</th> <th>7</th> </tr> </thead> <tbody> <tr> <td>Relay (Bit 0)</td> <td>0</td> <td>1</td> <td>0</td> <td>1</td> <td>0</td> <td>1</td> <td>0</td> <td>1</td> </tr> <tr> <td>TB14 (Bit 1)</td> <td>0</td> <td>0</td> <td>1</td> <td>1</td> <td>0</td> <td>0</td> <td>1</td> <td>1</td> </tr> <tr> <td>I/O option Relay (Bit 2)</td> <td>0</td> <td>0</td> <td>0</td> <td>0</td> <td>1</td> <td>1</td> <td>1</td> <td>1</td> </tr> </tbody> </table>			Value set in P793	0	1	2	3	4	5	6	7	Relay (Bit 0)	0	1	0	1	0	1	0	1	TB14 (Bit 1)	0	0	1	1	0	0	1	1	I/O option Relay (Bit 2)	0	0	0	0	1	1	1	1	bit = 0: OFF (De-energized) bit = 1: ON (Energized) The corresponding digital output/relay must be set to accept data from the sequencer: P140, P142, P441 = 27
Value set in P793	0	1	2	3	4	5	6	7																																		
Relay (Bit 0)	0	1	0	1	0	1	0	1																																		
TB14 (Bit 1)	0	0	1	1	0	0	1	1																																		
I/O option Relay (Bit 2)	0	0	0	0	1	1	1	1																																		



Commissioning

Code		Possible Settings			IMPORTANT
No.	Name	Default	Selection		
P794	End Segment: TB30 Analog Output Value	0.00	0.00	{VDC} 10.00	TB30 configuration parameter must be set to accept this value: P150 = 10
P795	End Segment: Drive Action	0	0	Keep Running	Recovery: Toggling the START SEQUENCE will start the cycle from 'end segment Stop' or 'end segment DC Brake'.
			1	Stop (based on P111)	
2	Coast to Stop				
3	Quick Stop (per P127)				
4	Coast with DC Brake				
			5	Ramp with DC Brake	
			WARNING! If P795 = 0 then toggling the start sequence input will also restart the sequencer cycle but in the interim where TB13X is open the drive will ramp to the standard or specified alternate speed source depending on the drive configuration.		



WARNING

If the input defined to "Start Sequence" is opened during a sequence, the drive will exit sequencer mode and will run at the specified standard or alternate speed source (dependent on drive configuration).



4.5.9.1 Sequencer Flow Diagram Left

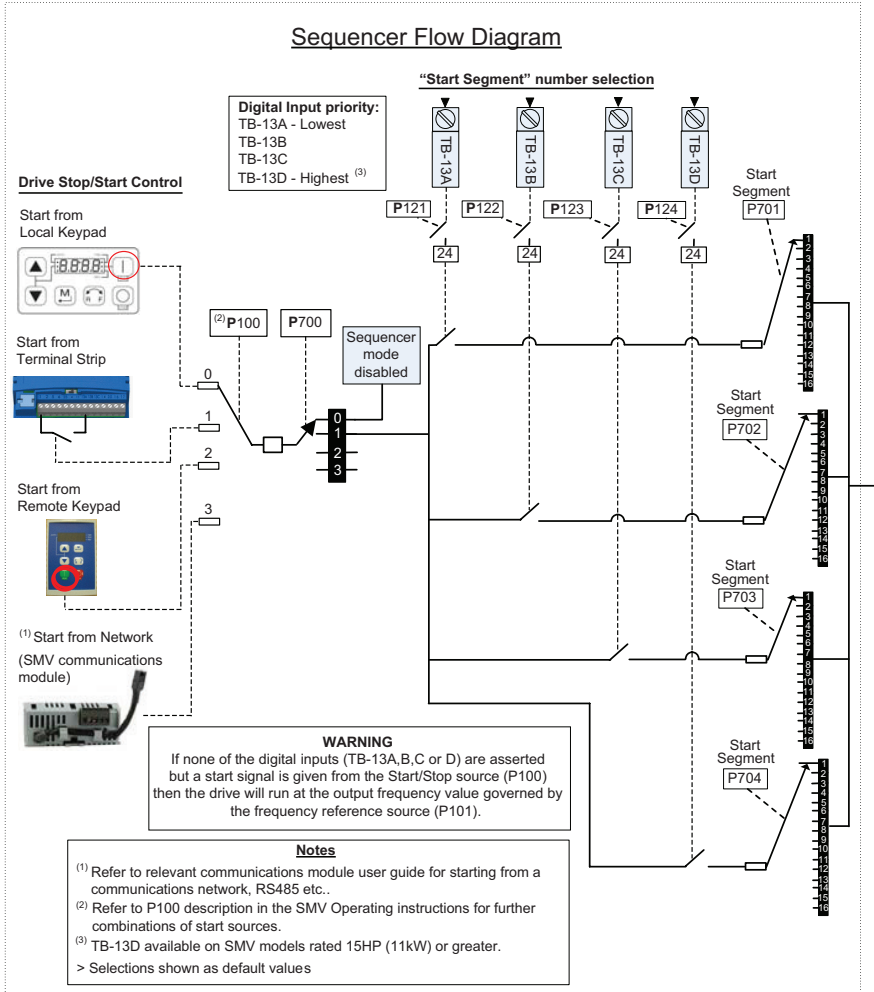

WARNING

If the input defined to "Start Sequence" is opened during a sequence, the drive will exit sequencer mode and will run at the specified standard or alternate speed source (dependent on drive configuration).



Commissioning

4.5.9.2 Sequencer Flow Diagram Right

Action after Stop/Start (P100) transition/digital input (if setup for sequencer mode) transition or restart after trip.	
P706	Action
0	Restart at beginning of sequence (pointed by TB13x)
1	Restart at beginning of current segment
2	Start at beginning of prior segment
3	Start at beginning of next segment

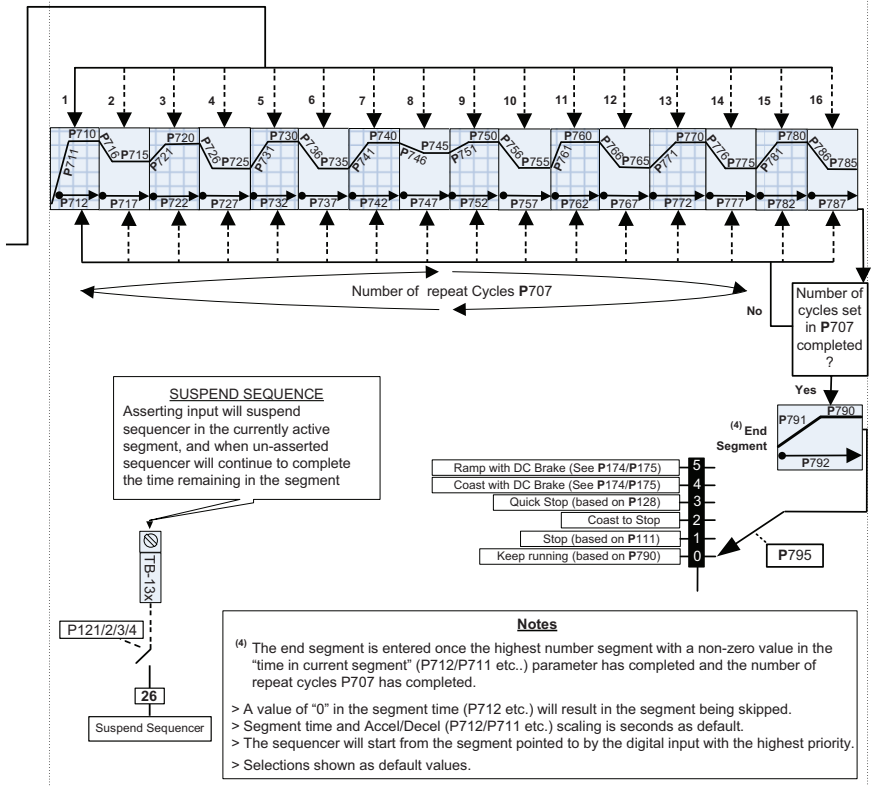

4.5.9.3 Sequencer Status

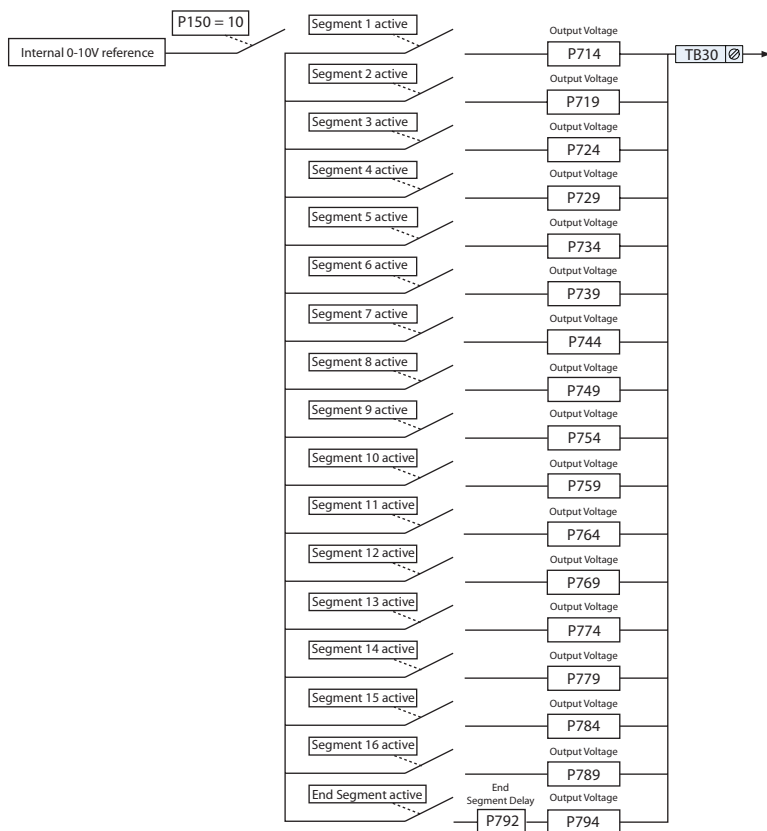

NOTE

On the "End Segment", the output voltage is not present until after the end segment delay P792 has expired. On the other segments the output voltage is present on entry to the segment. The same is true for the digital outputs.

(1) The drive can only be restarted if the error message has been reset.



Troubleshooting and Diagnostics

5 Troubleshooting and Diagnostics

5.1 Status/Warning Messages

Status / Warning	Cause	Remedy
br DC-injection brake active	DC-injection brake activated <ul style="list-style-type: none"> activation of digital input (P121...P124 = 18) automatically (P110 = 2, 4...6) automatically (P111 = 1, 3) 	Deactivate DC-injection brake <ul style="list-style-type: none"> deactivate digital input automatically after P175 time has expired
bF Drive ID warning	The Drive ID (P502) stored on the EPM does not match the drive model.	<ul style="list-style-type: none"> Verify motor data (P302...P306) and perform Auto Calibration. Set drive mode (P300) to 0 or 1 Reset the drive (P199 to 3 or 4) and reprogram.
CAL Motor Auto-calibration active	Refer to P300, P399	Motor Auto-calibration is being performed
cE An EPM that contains valid data from a previous software version has been installed	An attempt was made to change parameter settings	Parameter settings can only be changed after the EPM data is converted to the current version (P199 = 5)
CL Current Limit (P171) reached	Motor overload	<ul style="list-style-type: none"> Increase P171 Verify drive/motor are proper size for application
dEC Decel Override	The drive has stopped decelerating to avoid tripping into HF fault, due to excessive motor regen (2 sec max).	If drive trips into HF fault: <ul style="list-style-type: none"> Increase P105, P126 Install Dynamic Braking option
Err Error	Invalid data was entered, or an invalid command was attempted	
FCL Fast Current Limit	Overload	Verify drive/motor are proper size for application
FSt Flying Restart Attempt after Fault	P110 = 5,6	
GE OEM Settings Operation warning	An attempt was made to change parameter settings while the drive is operating in OEM Settings mode.	In OEM Settings mode (P199 = 1), making changes to parameters is not permitted.
GF OEM Defaults data warning	An attempt was made to use (or reset to) the OEM default settings (P199 = 1 or 2) using an EPM without valid OEM data.	Install an EPM containing valid OEM Defaults data
LC Fault Lockout	The drive attempted 5 restarts after a fault but all attempts were unsuccessful (P110 = 3...6)	<ul style="list-style-type: none"> Drive requires manual reset Check Fault History (P500) and correct fault condition
PdEC PID Deceleration Status	PID setpoint has finished its ramp but the drive is still decelerating to a stop.	
Pi d PID Mode Active	Drive has been put into PID Mode.	Refer to P200
SLP Sleep Mode is active	Refer to P240...P242	
SP Start Pending	The drive has tripped into a fault and will automatically restart (P110 = 3...6)	To disable Auto-Restart, set P110 = 0...2
SPd PID Mode disabled.	Drive has been taken out of PID Mode. Refer to P200.	
StoP Output frequency = 0 Hz (outputs U, V, W inhibited)	Stop has been commanded from the keypad, terminal strip, or network	Apply Start command (Start Control source depends on P100)

(1) The drive can only be restarted if the error message has been reset.



5.2 Drive Configuration Messages

When the Mode button is pressed and held, the drive's display will provide a 4-digit code that indicates how the drive is configured. If the drive is in a Stop state when this is done, the display will also indicate which control source commanded the drive to Stop (the two displays will alternate every second).

Configuration Display			
Format = x.y.zz	x = Control Source: L = Local Keypad t = Terminal Strip r = Remote Keypad n = Network	y = Mode: S = Speed mode P = PID mode t = Torque mode C = Sequencer mode	zz = Reference: CP = Keypad ▲ ▼ EU = 0-10 VDC (TB-5) EI = 4-20 mA (TB-25) JG = Jog nt = Network OP = MOP P L...P7 = Preset 1...7 D L...I6 = Sequencer Segment
Example: L.S.CP = Local Keypad Start control, Speed mode, Keypad speed reference t.P.EU = Terminal Strip Start control, PID mode, 0-10 VDC setpoint reference t.C.I2 = Terminal Strip Start control, Sequencer Operation (Speed mode), Segment #12 n.t.P2 = Network Start control, Vector Torque mode, Preset Torque #2 reference n.S.O3 = Network Start control, Speed mode, Speed reference from Sequencer segment #03			
Stop Source Display			
Format = x.S.tP	L.S.tP = Stop command came from Local Keypad t.S.tP = Stop command came from Terminal Strip r.S.tP = Stop command came from Remote Keypad n.S.tP = Stop command came from Network		

5.3 Fault Messages

The messages below show how they will appear on the display when the drive trips. When looking at the Fault History (P500), the F_ will not appear in the fault message.

Fault	Cause	Remedy ⁽¹⁾
F_AF High Temperature fault	Drive is too hot inside	<ul style="list-style-type: none"> Reduce drive load Improve cooling
F_AL Assertion Level fault	<ul style="list-style-type: none"> Assertion Level switch is changed during operation P120 is changed during operation P100 or P121...P124 are set to a value other than 0 and P120 does not match the Assertion Level Switch. 	<ul style="list-style-type: none"> Make sure the Assertion Level switch and P120 are both set for the type of input devices being used, prior to setting P100 or P121...P124. Refer to 3.2.3 and P120.
F_bF Personality fault	Drive Hardware	<ul style="list-style-type: none"> Cycle Power
F_cF Control fault	An EPM has been installed that is either blank or corrupted	<ul style="list-style-type: none"> Power down and install EPM with valid data Reset the drive back to defaults (P199 = 3, 4) and then re-program
F_cF Incompatible EPM fault	An EPM has been installed that contains data from an incompatible parameter version	<ul style="list-style-type: none"> If problem persists, contact factory technical support
F_cFt Forced Translation fault	An EPM from an old drive put in new drive causes drive to trip F_cFT fault.	Press [M] (mode button) twice to reset



Troubleshooting and Diagnostics

	Fault	Cause	Remedy ⁽¹⁾
F_dbF	Dynamic Braking fault	Dynamic braking resistors are overheating	<ul style="list-style-type: none"> Increase active decel time (P105, P126, P127). Check mains voltage and P107
F_EF	External fault	<ul style="list-style-type: none"> P121...P124 = 21 and that digital input has been opened. P121...P124 = 22 and that digital input has been closed. 	<ul style="list-style-type: none"> Correct the external fault condition Make sure digital input is set properly for NC or NO circuit
F_F I	EPM fault	EPM missing or defective	Power down and replace EPM
F_F2 ... F_F I2	Internal faults		Contact factory technical support
F_Fnr	Control Configuration Fault	The drive is setup for REMOTE KEYPAD control (P100=2 or 5) but is not setup to communicate with a remote keypad	Set P400 = 1, or P600 = 1
		The drive is setup for NETWORK ONLY control (P100=3) but is not setup for network communications	Set P400 or P600 to a valid network communications protocol selection
F_FoL	TB25 (4-20 mA signal) Threshold fault	4-20 mA signal (at TB-25) drops below the value set in P164.	<ul style="list-style-type: none"> Check signal/signal wire Refer to parameters P163 and P164.
F_GF	OEM Defaults data fault	Drive is powered up with P199 = 1 and OEM settings in the EPM are not valid.	Install an EPM containing valid OEM Defaults data or change P199 to 0.
F_HF	High DC Bus Voltage fault	Mains voltage is too high	Check mains voltage and P107
		Decel time is too short, or too much regen from motor	Increase active decel time (P105, P126, P127) or install Dynamic Braking option
F_IL	Digital Input Configuration fault (P121...P124)	More than one digital input set for the same function	Each setting can only be used once (except settings 0 and 3)
		Only one digital input configured for MOP function (Up, Down)	One input must be set to MOP Up, another must be set to MOP Down
		PID mode is entered with setpoint reference and feedback source set to the same analog signal	Change PID setpoint reference (P121...P124) or feedback source (P201).
		One of the digital inputs (P121...P124) is set to 10 and another is set to 11...14.	Reconfigure digital inputs
		One of the digital inputs (P121...P124) is set to 11 or 12 and another is set to 13 or 14.	
		PID enabled in Vector Torque mode (P200 = 1 or 2 and P300 = 5)	PID cannot be used in Vector Torque mode
F_JF	Remote keypad fault	Remote keypad disconnected	Check remote keypad connections
F_LF	Low DC Bus Voltage fault	Mains voltage too low	Check mains voltage
F_nId	No Motor ID fault	An attempt was made to start the drive in Vector or Enhanced V/Hz mode prior to performing the Motor Auto-calibration	Refer to parameters P300...P399 for Drive Mode setup and calibration.
F_nIF	Module communication fault	Communication failure between drive and Network Module.	Check module connections
F_nF I ... F_nF9	Network Faults	Refer to the module documentation. for Causes and Remedies.	



Fault		Cause	Remedy ⁽¹⁾
F_DF	Output fault: Transistor fault	Output short circuit	Check motor/motor cable
		Acceleration time too short	Increase P104, P125
		Severe motor overload, due to: <ul style="list-style-type: none"> • Mechanical problem • Drive/motor too small for application 	<ul style="list-style-type: none"> • Check machine / system • Verify drive/motor are proper size for application
		Boost values too high	Decrease P168, P169
		Excessive capacitive charging current of the motor cable	<ul style="list-style-type: none"> • Use shorter motor cables with lower charging current • Use low capacitance motor cables • Install reactor between motor and drive.
		Failed output transistor	Contact factory technical support
F_DF I	Output fault: Ground fault	Grounded motor phase	Check motor and motor cable
		Excessive capacitive charging current of the motor cable	Use shorter motor cables with lower charging current
F_PF	Motor Overload fault	Excessive motor load for too long	<ul style="list-style-type: none"> • Verify proper setting of P108 • Verify drive and motor are proper size for application
F_rF	Flying Restart fault	Controller was unable to synchronize with the motor during restart attempt; (P110 = 5 or 6)	Check motor / load
F_SF	Single-Phase fault	A mains phase has been lost	Check mains voltage
F_UF	Start fault	Start command was present when power was applied (P110 = 0 or 2).	<ul style="list-style-type: none"> • Must wait at least 2 seconds after power-up to apply Start command • Consider alternate starting method (P110).
F_FAU	TB5 (0-10V signal) Threshold fault	0-10V signal (at TB5) drops below the value set in P158.	<ul style="list-style-type: none"> • Check signal/signal wire • Refer to parameters P157 and P158

(1) The drive can only be restarted if the error message has been reset.



Appendix

Appendix A

A.1 Permissible Cable Lengths

The table herein lists the permissible cable lengths for use with an SMV inverter with an internal EMC filter.



NOTE

This table is intended as a reference guideline only; application results may vary. The values in this table are based on testing with commonly available low-capacitance shielded cable and commonly available AC induction motors. Testing is conducted at worst case speeds and loads.

Maximum Permissible Cable Lengths (Meters) for SMV Model with Internal EMC Filters									
Mains	Model	4 kHz Carrier (P166 = 0)		6 kHz Carrier (P166 = 1)		8 kHz Carrier (P166 = 2)		10 kHz Carrier (P166 = 3)	
		Class A	Class B	Class A	Class B	Class A	Class B	Class A	Class B
240 V, 1-phase (2/PE)	ESV251 $\phi\phi$ 2SF ϕ	38	12	35	10	33	5	30	N/A
	ESV371 $\phi\phi$ 2SF ϕ	38	12	35	10	33	5	30	N/A
	ESV751 $\phi\phi$ 2SF ϕ	38	12	35	10	33	5	30	N/A
	ESV112 $\phi\phi$ 2SF ϕ	38	12	35	10	33	5	30	N/A
	ESV152 $\phi\phi$ 2SF ϕ	38	12	35	10	33	5	30	N/A
	ESV222 $\phi\phi$ 2SF ϕ	38	12	35	10	33	5	30	N/A
400/480 V, 3-phase (3/PE)	ESV371 $\phi\phi$ 4TF ϕ	30	4	25	2	20	N/A	10	N/A
	ESV751 $\phi\phi$ 4TF ϕ	30	4	25	2	20	N/A	10	N/A
	ESV112 $\phi\phi$ 4TF ϕ	30	4	25	2	20	N/A	10	N/A
	ESV152 $\phi\phi$ 4TF ϕ	30	4	25	2	20	N/A	10	N/A
	ESV222 $\phi\phi$ 4TF ϕ	30	4	25	2	20	N/A	10	N/A
	ESV302 $\phi\phi$ 4TF ϕ	30	4	25	2	20	N/A	10	N/A
	ESV402 $\phi\phi$ 4TF ϕ	54	5	48	3	42	2	N/A	N/A
	ESV552 $\phi\phi$ 4TF ϕ	54	5	48	3	42	2	N/A	N/A
	ESV752 $\phi\phi$ 4TF ϕ	54	5	48	3	42	2	N/A	N/A

NOTE: The “ $\phi\phi$ ” and “ ϕ ” symbols are place holders in the Model part number that contain different information depending on the specific configuration of the model. Refer to the SMV Type Number Designation table in section 2.2 for more information.



Lenze SMVector 13465100 EDBSV01 EN v18



Lenze Americas Corporation
630 Douglas Street
Uxbridge, MA 01569
USA

 800 217-9100
 508 278-7873
 marketing@lenzeamericas.com
 www.Lenze.com

Service
Lenze AC Tech Corporation
630 Douglas Street
Uxbridge, MA 01569
USA

 508 278-9100
 508 278-6620
 repair@lenzeamericas.com