

Catalog

## 22 mm Pilot Devices

LED Indicator Lights and Pushbuttons



Ex9IL Series



Ex9PB Series

## NOARK Electric

### Electrical Equipment Manufacturer for Distribution and Control



NOARK Electric is a global manufacturer of electrical distribution and control products that address a variety of customer needs, ranging from components to intelligent system solutions. Our global product lines include: circuit breakers, contactors, relays and intelligent control. Based in Shanghai, China, NOARK Electric was established in 2007 and covers the globe with regional headquarters in North America, Latin America, Europe and Middle East/Africa.

Globally, NOARK Electric serves the industrial, commercial, utility and residential markets. In North America, NOARK Electric focuses primarily on industrial OEMs, users and associated channel partners. Our motto is "Excellent Product...Exceptional Value," which NOARK Electric delivers to our customer by maintaining local inventory, providing local sales, customer service and support and manufacturing quality, aggressively priced products backed by a five-year limited warranty.

#### Quality Product

- Backed by a five-year limited warranty\*



#### Exceptional Value

- Reduce the cost of products
- Improve profitability
- Increase margins

#### Local Support and Local Inventory

- Superb customer service
- Knowledgeable technical support
- Dedicated sales force
- Well-stocked inventory
- North American headquarters

\*Contact NOARK Electric for complete details.

## NOARK Electric

### International Headquarter Locations



## Global reach. Local resources.

The best of both worlds come together when customers count on NOARK as their electrical product manufacturer.



# NOARK Electric

## Table of Contents

### A Ex9IL 22 mm Indicator Lights

Product Overview.....	A3
National and International Standards .....	A4
Product Selection Guide .....	A5
Products	
Ex9IL1 Compacted Flat Lampshade .....	A6
Ex9IL2 Compacted Curve Lampshade .....	A7
Specifications .....	A8
Dimensions .....	A9



### B Ex9PB 22 mm Pushbuttons

Product Overview.....	B11
National and International Standards .....	B12
Specifications .....	B13
Product Guide .....	B14
Non-Illuminated Products	
Ex9PBA Momentary Flush.....	B15
Ex9PBA+Symbol Momentary Flush+Symbol.....	B15
Ex9PBL Momentary Extended .....	B15
Ex9PBC Momentary ø40mm Mushroom Head.....	B16
Ex9PBR Momentary ø60mm Mushroom Head .....	B16
Ex9PBS Push On ø30mm Mushroom Head .....	B17
Ex9PBL8 Momentary Double Head Flush and Extended .....	B17
Ex9PBD Selector Switch - Rotary Knob.....	B18
Ex9PBJ Selector Switch - Rotary Handle.....	B18
Ex9PBG Selector Switch - Key .....	B19
Illuminated Products	
Ex9PBW3 Momentary Flush with Guard.....	B20
Ex9PBV6 Indicator Light.....	B21
Ex9PBW8 Momentary Double Head Flush+Projecting .....	B21
Dimensions .....	B22-23



### C 22 mm Pushbutton Accessories

Accessories Overview .....	C25
Accessories	
Replacement Heads - Non-Illuminated.....	C26-27
Replacement Heads - Illuminated .....	C28
Accessories.....	C29
Contact Blocks .....	C30
LED Lamp Replacements .....	C30
Enclosures.....	C31-33



# 22 MM LED INDICATOR LIGHTS



# Ex9IL

## 22 mm Indicator Lights

### Ex9IL Product Overview

# Features

A

- Metal construction for superior durability and visual appeal
- UL listed and IP 40\* (front) available for protection against dust and water
- Low behind the panel depth
- Operators mount in a round 7/8 in (22.5 mm) hole that is interchangeable with competitor's products
- Field convertible from maintained to momentary (available on maintained pushbuttons only)
- Modular construction makes assembly fast and simplifies stocking of components and complete devices

\* Indicator lights available up to IP 65. Contact a NOARK representative for more information.

## 22 mm Indicator Lights

### Ex9IL National and International Standards

#### Certifications

- UL Listed, File Number E353866
- Certified for Canada according to CSA standards
- IEC/EN 60947
- VDE 0660
- CE Approved
- RoSH Compliant





# 22 mm Indicator Lights

## Ex9IL Product Selection Guide

### Label

A



### Product Selection Guide

<b>Ex9IL</b>	<b>1</b>	<b>A</b>	<b>1</b>
NOARK Ex9IL Series	Lampshade Style	Voltage	Color
	1: Flat	A: 6 V	1: White
	2: Curve	C: 12 V	3: Green
		D: 24 V	4: Red
		E: 36 V	5: Yellow
		F: 48 V	6: Blue
		N: 110/120 V	
		H: 220/240 V	
		K: 380 V	

## 22 mm Indicator Lights

### Ex9IL1 Compacted Flat Lampshade



**Certifications**  
IEC/EN 60947-5-1

CE e (UL) US LISTED

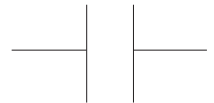

#### Resistance Type

Color	LED Lamp Voltage (Vac/dc)	Product	Part Number
○	6	Ex9IL1A1	1200665
●		Ex9IL1A3	1200666
●		Ex9IL1A4	1200667
●		Ex9IL1A5	1200668
●		Ex9IL1A6	1200669
○		12	Ex9IL1C1
●	Ex9IL1C3		1200671
●	Ex9IL1C4		1200672
●	Ex9IL1C5		1200673
●	Ex9IL1C6		1200674
○	24		Ex9IL1D1
●		Ex9IL1D3	1200676
●		Ex9IL1D4	1200677
●		Ex9IL1D5	1200678
●		Ex9IL1D6	1200679
○		36	Ex9IL1E1
●	Ex9IL1E3		1200681
●	Ex9IL1E4		1200682
●	Ex9IL1E5		1200683
●	Ex9IL1E6		1200684
○	48		Ex9IL1F1
●		Ex9IL1F3	1200686
●		Ex9IL1F4	1200687
●		Ex9IL1F5	1200688
●		Ex9IL1F6	1200689

#### Capacitance Type

Color	LED Lamp Voltage (Vac)	Product	Part Number
○	110/120	Ex9IL1N1	1200690
●		Ex9IL1N3	1200691
●		Ex9IL1N4	1200692
●		Ex9IL1N5	1200693
●		Ex9IL1N6	1200694
○		220/240	Ex9IL1H1
●	Ex9IL1H3		1200696
●	Ex9IL1H4		1200697
●	Ex9IL1H5		1200698
●	Ex9IL1H6		1200699
○	380		Ex9IL1K1
●		Ex9IL1K3	1200701
●		Ex9IL1K4	1200702
●		Ex9IL1K5	1200703
●		Ex9IL1K6	1200704

# 22 mm Indicator Lights

## Ex9IL2 Compacted Curve Lampshade



**Certifications**  
IEC/EN 60947-5-1

CE cULus LISTED



A

### Resistance Type

Color	LED Lamp Voltage (Vac/dc)	Product	Part Number
○	6	Ex9IL2A1	1200705
●		Ex9IL2A3	1200706
●		Ex9IL2A4	1200707
●		Ex9IL2A5	1200708
●		Ex9IL2A6	1200709
○		12	Ex9IL2C1
●	Ex9IL2C3		1200711
●	Ex9IL2C4		1200712
●	Ex9IL2C5		1200713
●	Ex9IL2C6		1200714
○	24		Ex9IL2D1
●		Ex9IL2D3	1200716
●		Ex9IL2D4	1200717
●		Ex9IL2D5	1200718
●		Ex9IL2D6	1200719
○		36	Ex9IL2E1
●	Ex9IL2E3		1200721
●	Ex9IL2E4		1200722
●	Ex9IL2E5		1200723
●	Ex9IL2E6		1200724
○	48		Ex9IL2F1
●		Ex9IL2F3	1200726
●		Ex9IL2F4	1200727
●		Ex9IL2F5	1200728
●		Ex9IL2F6	1200729

### Capacitance Type

Color	LED Lamp Voltage (Vac)	Product	Part Number
○	110/120	Ex9IL2N1	1200730
●		Ex9IL2N3	1200731
●		Ex9IL2N4	1200732
●		Ex9IL2N5	1200733
●		Ex9IL2N6	1200734
○		220/240	Ex9IL2H1
●	Ex9IL2H3		1200736
●	Ex9IL2H4		1200737
●	Ex9IL2H5		1200738
●	Ex9IL2H6		1200739
○	380		Ex9IL2K1
●		Ex9IL2K3	1200741
●		Ex9IL2K4	1200742
●		Ex9IL2K5	1200743
●		Ex9IL2K6	1200744

## 22 mm Indicator Lights

### Ex9IL Specifications

		Ex9IL
Rated Operational Voltage Ue (V)	Vac	110~380
	Vac/dc	6~48
Rated Operational Current (mA)		$I_e \leq 20$
Service Life (h)		$\geq 30,000$
Brightness (cd/m <sup>2</sup> )		$\geq 60$
Basic Colors		

Note: For AC power supply, the limit voltage range is  $0.85U_e \sim 1.1U_e$  between terminals.

# 22 mm Indicator Lights

## Ex9IL Dimensions

### Ex9IL1

Unit: in [mm]

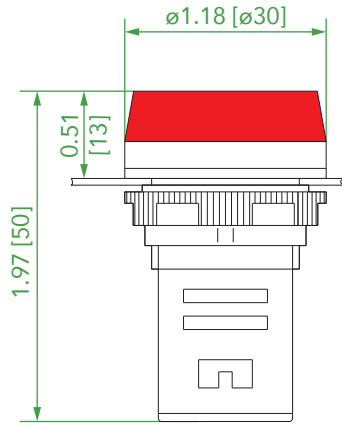

### Ex9IL2

Unit: in [mm]

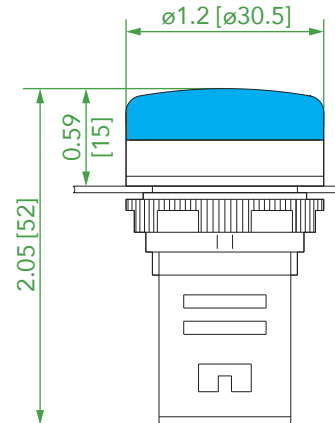

A

# 22 MM PUSHBUTTONS



# Ex9PB

## 22 mm Pushbuttons

### Ex9PB Product Overview

# Features

B

- Metal construction for superior durability and visual appeal
- UL recognized component and labeled IP 40\* (front) for protection against dust and water
- LED replaceable lamps are standard
- Low behind the panel depth
- Operators mount in a round 7/8 in (22.5 mm) hole that is interchangeable with competitor's products
- Field convertible from maintained to momentary (available on maintained pushbuttons only)
- More than one million mechanical operations on momentary and half million on maintained pushbuttons
- Modular construction makes assembly fast and simplifies stocking of components and complete devices

\* Ex9PBA momentary flush pushbuttons available up to IP 65. Contact a NOARK representative for more information.

## 22 mm Pushbuttons

### Ex9PB National and International Standards

#### Certifications

- UL Recognized Component, File Number E353865
- Certified for Canada according to CSA standards
- IEC/EN 60947
- VDE 0660
- CE Approved
- RoSH Compliant





# 22 mm Pushbuttons

## Ex9PB Specifications

### Label

B

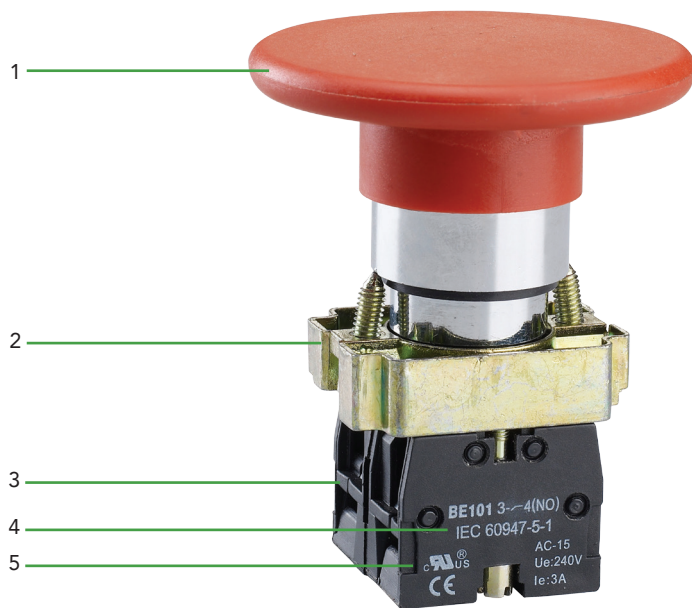

- 1 Head
- 2 Middle Adapter
- 3 Base
- 4 IEC Standard
- 5 UL Recognized Component and CE Mark

### Specifications

		Ex9PB		
Rated Operational Voltage $U_e$ (V)		125	240	415
Rated Operational Current (mA)	15 Vac	-	3	1.9
	13 Vdc	0.55	0.27	-
<b>Illuminated Button Lamp Parameters</b>		<b>Direct Type LED Lamp</b>		<b>Transformer Type 6V LED Lamp</b>
Rated Operational Current $I_e$ (mA)		$I_e \leq 20$		$I_e \leq 20$
Rated Operational Voltage (V)		6~230 Vac/dc		230~380 Vac/dc

Note: 1) Rated insulation voltage  $U_i$ : 415 V  
 2) Conventional thermal current  $I_{th}$ : 10 A

## 22 mm Pushbuttons Ex9PB Product Guide



**Non-Illuminated  
Momentary Flush  
B15**



**Non-Illuminated  
Momentary Flush+Symbol  
B15**

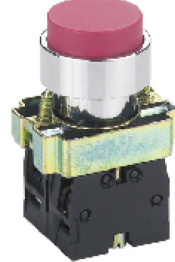

**Non-Illuminated  
Momentary Extended  
B15**



**Non-Illuminated Momentary  
ø40 mm Mushroom Head  
B16**



**Non-Illuminated Momentary  
ø60 mm Mushroom Head  
B16**



**Non-Illuminated Push On/Twist Off  
ø30~60 mm Mushroom Head  
B17**

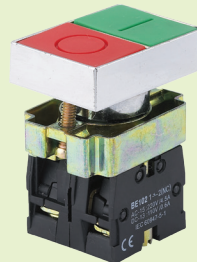

**Non-Illuminated Momentary  
Double Head - Flush  
B17**

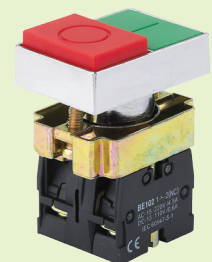

**Non-Illuminated Momentary  
Double Head - Extended  
B17**



**Non-Illuminated  
Selector Switch - Rotary Knob  
B18**



**Non-Illuminated  
Selector Switch - Rotary Handle  
B18**



**Non-Illuminated  
Selector Switch - Key  
B19**



**Illuminated  
Momentary Flush with Guard  
B20**



**Illuminated  
Indicator Light  
B21**



**Illuminated  
Momentary Double Head Flush+Projecting  
B21**

# 22 mm Pushbuttons

## Ex9PBA, Ex9PBA+Symbol and Ex9PBL Non-Illuminated



**Certifications**  
IEC/EN 60947-5-1



B

### Momentary Flush\*

Color	Contacts	Product	Part Number
○	1NO	Ex9PBA11	1200000
●		Ex9PBA21	1200001
●		Ex9PBA31	1200002
●		Ex9PBA41	1200003
●		Ex9PBA51	1200004
●		Ex9PBA61	1200005
○	1NC	Ex9PBA12	1200006
●		Ex9PBA22	1200007
●		Ex9PBA32	1200008
●		Ex9PBA42	1200009
●		Ex9PBA62	1200011
○	2NO	Ex9PBA13	1200012
●		Ex9PBA23	1200013
●		Ex9PBA33	1200014
●		Ex9PBA43	1200015
●		Ex9PBA53	1200016
●		Ex9PBA63	1200017
○	2NC	Ex9PBA14	1200018
●		Ex9PBA24	1200019
●		Ex9PBA34	1200020
●		Ex9PBA44	1200021
●		Ex9PBA54	1200022
●		Ex9PBA64	1200023
○	1NO+1NC	Ex9PBA15	1200024
●		Ex9PBA25	1200025
●		Ex9PBA35	1200026
●		Ex9PBA45	1200027
●		Ex9PBA55	1200028
●		Ex9PBA65	1200029

### Momentary Flush+Symbol\*

Color	Contacts	Product	Part Number
①	1NO	Ex9PBA3311	1200030
②	1NO+1NC	Ex9PBA2365	1200031
③	1NC	Ex9PBA4322	1200032
④	1NO	Ex9PBA2351	1200033
⑤	1NO+1NC	Ex9PBA1345	1200034



### Momentary Extended

Color	Contacts	Product	Part Number
○	1NO+1NC	Ex9PBL15	1200039
●	1NO	Ex9PBL21	1200040
●	1NO	Ex9PBL31	1200036
●	1NC	Ex9PBL42	1200035
●	1NO+1NC	Ex9PBL55	1200037
●	1NO+1NC	Ex9PBL65	1200038

Specifications ..... B13      Dimensions ..... B22      Accessories ..... C26 to 33

\* Ex9PBA momentary flush pushbuttons available up to IP 65. Contact a NOARK representative for more information.

## 22 mm Pushbuttons Ex9PBC and Ex9PBR Non-Illuminated



### Momentary ø40 mm Mushroom Head

Color	Contacts	Product	Part Number
○	1NO	Ex9PBC11	1200378
●		Ex9PBC21	1200379
●		Ex9PBC31	1200380
●		Ex9PBC41	1200381
●		Ex9PBC51	1200382
●		Ex9PBC61	1200383
○	1NC	Ex9PBC12	1200384
●		Ex9PBC22	1200385
●		Ex9PBC32	1200386
●		Ex9PBC42	1200387
●		Ex9PBC52	1200388
●		Ex9PBC62	1200389
○	2NO	Ex9PBC13	1200390
●		Ex9PBC23	1200391
●		Ex9PBC33	1200392
●		Ex9PBC43	1200393
●		Ex9PBC53	1200394
●		Ex9PBC63	1200395
○	2NC	Ex9PBC14	1200396
●		Ex9PBC24	1200397
●		Ex9PBC34	1200398
●		Ex9PBC44	1200399
●		Ex9PBC54	1200400
●		Ex9PBC64	1200401
○	1NO+1NC	Ex9PBC15	1200402
●		Ex9PBC25	1200403
●		Ex9PBC35	1200404
●		Ex9PBC45	1200405
●		Ex9PBC55	1200406
●		Ex9PBC65	1200407

### Momentary ø60 mm Mushroom Head

Color	Contacts	Product	Part Number
○	1NO	Ex9PBR11	1200408
●		Ex9PBR21	1200409
●		Ex9PBR31	1200410
●		Ex9PBR41	1200411
●		Ex9PBR51	1200412
●		Ex9PBR61	1200413
○	1NC	Ex9PBR12	1200414
●		Ex9PBR22	1200415
●		Ex9PBR32	1200416
●		Ex9PBR42	1200417
●		Ex9PBR52	1200418
●		Ex9PBR62	1200419
○	2NO	Ex9PBR13	1200420
●		Ex9PBR23	1200421
●		Ex9PBR33	1200422
●		Ex9PBR43	1200423
●		Ex9PBR53	1200424
●		Ex9PBR63	1200425
○	2NC	Ex9PBR14	1200426
●		Ex9PBR24	1200427
●		Ex9PBR34	1200428
●		Ex9PBR44	1200429
●		Ex9PBR54	1200430
●		Ex9PBR64	1200431
○	1NO+1NC	Ex9PBR15	1200432
●		Ex9PBR25	1200433
●		Ex9PBR35	1200434
●		Ex9PBR45	1200435
●		Ex9PBR55	1200436
●		Ex9PBR65	1200437

# 22 mm Pushbuttons

## Ex9PBS and Ex9PBL8 Non-Illuminated



**Certifications**  
IEC/EN 60947-5-1

CE 

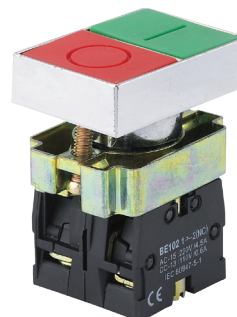

B

### Push On/Twist Off ø30 mm Mushroom Head

Color	Contacts	Product	Part Number
●	1NO	Ex9PBS441	1200448
	1NC	Ex9PBS442	1200449
	2NO	Ex9PBS443	1200450
	2NC	Ex9PBS444	1200451
	1NO+1NC	Ex9PBS445	1200452

### Momentary Double Head - Flush

Color	Contacts	Product	Part Number
● + ●	1NO+1NC	Ex9PBL8325	1200438

### Push On/Twist Off ø40 Mushroom Head

●	1NO	Ex9PBS541	1200453
	1NC	Ex9PBS542	1200454
	2NO	Ex9PBS543	1200455
	2NC	Ex9PBS544	1200456
	1NO+1NC	Ex9PBS545	1200457

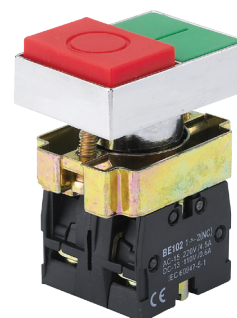

### Push On/Twist Off ø60 Mushroom Head

●	1NO	Ex9PBS641	1200458
	1NC	Ex9PBS642	1200459
	2NO	Ex9PBS643	1200460
	2NC	Ex9PBS644	1200461
	1NO+1NC	Ex9PBS645	1200462

### Momentary Double Head - Extended

Color	Contacts	Product	Part Number
● + ●	1NO+1NC	Ex9PBL8425	1200439

## 22 mm Pushbuttons Ex9PBD and Ex9PBJ Non-Illuminated



### Selector Switch - Rotary Knob

Positions	Contacts	Product	Part Number
<b>2-Position</b>			
	1NO	Ex9PBD21	1200503
	1NC	Ex9PBD22	1200504
	2NO	Ex9PBD23	1200505
	2NC	Ex9PBD24	1200506
	1NO+1NC	Ex9PBD25	1200507
	1NO	Ex9PBD41	1200508
	1NC	Ex9PBD42	1200509
	2NO	Ex9PBD43	1200510
	2NC	Ex9PBD44	1200511
	1NO+1NC	Ex9PBD45	1200512
<b>3-Position</b>			
	2NO	Ex9PBD33	1200538
	2NC	Ex9PBD34	1200539
	1NO+1NC	Ex9PBD35	1200540
	2NO	Ex9PBD53	1200541
	2NC	Ex9PBD54	1200542
	1NO+1NC	Ex9PBD55	1200543

### Selector Switch - Rotary Handle

Positions	Contacts	Product	Part Number
<b>2-Position</b>			
	1NO	Ex9PBJ21	1200513
	1NC	Ex9PBJ22	1200514
	2NO	Ex9PBJ23	1200515
	2NC	Ex9PBJ24	1200516
	1NO+1NC	Ex9PBJ25	1200517
	1NO	Ex9PBJ41	1200518
	1NC	Ex9PBJ42	1200519
	2NO	Ex9PBJ43	1200520
	2NC	Ex9PBJ44	1200521
	1NO+1NC	Ex9PBJ45	1200522
<b>3-Position</b>			
	2NO	Ex9PBJ33	1200544
	2NC	Ex9PBJ34	1200545
	1NO+1NC	Ex9PBJ35	1200546
	2NO	Ex9PBJ53	1200547
	2NC	Ex9PBJ54	1200548
	1NO+1NC	Ex9PBJ55	1200549

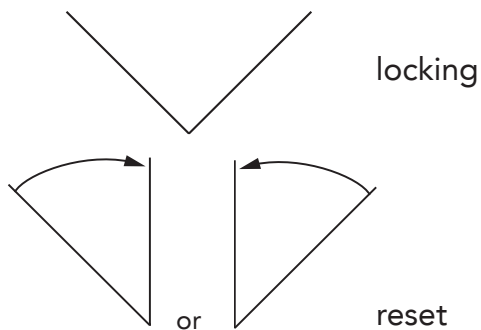

# 22 mm Pushbuttons

## Ex9PBG Non-Illuminated



**Certifications**  
IEC/EN 60947-5-1

CE cRU US

B

### Selector Switch - Key

Positions	Contacts	Product	Part Number
<b>2-Position</b>			
	1NO	Ex9PBG21	1200523
	1NC	Ex9PBG22	1200524
	2NO	Ex9PBG23	1200525
	2NC	Ex9PBG24	1200526
	1NO+1NC	Ex9PBG25	1200527
	1NO	Ex9PBG41	1200533
	1NC	Ex9PBG42	1200534
	2NO	Ex9PBG43	1200535
	2NC	Ex9PBG44	1200536
	1NO+1NC	Ex9PBG45	1200537
	1NO	Ex9PBG21B	1200528
	1NC	Ex9PBG22B	1200529
	2NO	Ex9PBG23B	1200530
	2NC	Ex9PBG24B	1200531
	1NO+1NC	Ex9PBG25B	1200532
<b>3-Position</b>			
	2NO	Ex9PBG33	1200550
	2NC	Ex9PBG34	1200551
	1NO+1NC	Ex9PBG35	1200552
	2NO	Ex9PBG53	1200553
	2NC	Ex9PBG54	1200554
	1NO+1NC	Ex9PBG55	1200555
	2NO	Ex9PBG33D	1200556
	2NC	Ex9PBG34D	1200557
	1NO+1NC	Ex9PBG35D	1200558

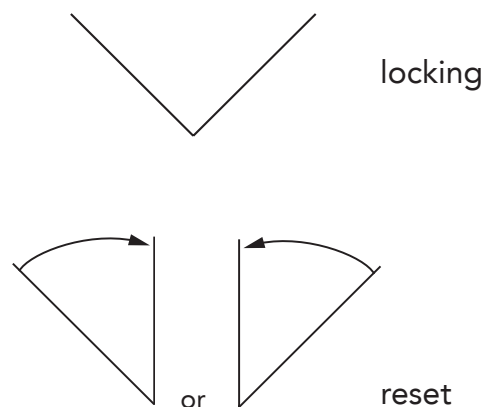

= Key removed at this position only.

## 22 mm Pushbuttons Ex9PBW3 Illuminated



### Momentary Flush with Guard

Color	LED Lamp Voltage Vac/dc	Product		Product		Product		Product		Product	
		1NO	Part Number	1NC	Part Number	2NO	Part Number	2NC	Part Number	1NO+1NC	Part Number
○ ● ● ● ●	6	Ex9PBW3161A	1200153	Ex9PBW3162A	1200193	Ex9PBW3163A	1200233	Ex9PBW3164A	1200273	Ex9PBW3165A	1200313
		Ex9PBW3361A	1200154	Ex9PBW3362A	1200194	Ex9PBW3363A	1200234	Ex9PBW3364A	1200274	Ex9PBW3365A	1200314
		Ex9PBW3461A	1200155	Ex9PBW3462A	1200195	Ex9PBW3463A	1200235	Ex9PBW3464A	1200275	Ex9PBW3465A	1200315
		Ex9PBW3561A	1200156	Ex9PBW3562A	1200196	Ex9PBW3563A	1200236	Ex9PBW3564A	1200276	Ex9PBW3565A	1200316
		Ex9PBW3661A	1200157	Ex9PBW3662A	1200197	Ex9PBW3663A	1200237	Ex9PBW3664A	1200277	Ex9PBW3665A	1200317
○ ● ● ● ●	12	Ex9PBW3161C	1200158	Ex9PBW3162C	1200198	Ex9PBW3163C	1200238	Ex9PBW3164C	1200278	Ex9PBW3165C	1200318
		Ex9PBW3361C	1200159	Ex9PBW3362C	1200199	Ex9PBW3363C	1200239	Ex9PBW3364C	1200279	Ex9PBW3365C	1200319
		Ex9PBW3461C	1200160	Ex9PBW3462C	1200200	Ex9PBW3463C	1200240	Ex9PBW3464C	1200280	Ex9PBW3465C	1200320
		Ex9PBW3561C	1200161	Ex9PBW3562C	1200201	Ex9PBW3563C	1200241	Ex9PBW3564C	1200281	Ex9PBW3565C	1200321
		Ex9PBW3661C	1200162	Ex9PBW3662C	1200202	Ex9PBW3663C	1200242	Ex9PBW3664C	1200282	Ex9PBW3665C	1200322
○ ● ● ● ●	24	Ex9PBW3161D	1200163	Ex9PBW3162D	1200203	Ex9PBW3163D	1200243	Ex9PBW3164D	1200283	Ex9PBW3165D	1200323
		Ex9PBW3361D	1200164	Ex9PBW3362D	1200204	Ex9PBW3363D	1200244	Ex9PBW3364D	1200284	Ex9PBW3365D	1200324
		Ex9PBW3461D	1200165	Ex9PBW3462D	1200205	Ex9PBW3463D	1200245	Ex9PBW3464D	1200285	Ex9PBW3465D	1200325
		Ex9PBW3561D	1200166	Ex9PBW3562D	1200206	Ex9PBW3563D	1200246	Ex9PBW3564D	1200286	Ex9PBW3565D	1200326
		Ex9PBW3661D	1200167	Ex9PBW3662D	1200207	Ex9PBW3663D	1200247	Ex9PBW3664D	1200287	Ex9PBW3665D	1200327
○ ● ● ● ●	36	Ex9PBW3161E	1200168	Ex9PBW3162E	1200208	Ex9PBW3163E	1200248	Ex9PBW3164E	1200288	Ex9PBW3165E	1200328
		Ex9PBW3361E	1200169	Ex9PBW3362E	1200209	Ex9PBW3363E	1200249	Ex9PBW3364E	1200289	Ex9PBW3365E	1200329
		Ex9PBW3461E	1200170	Ex9PBW3462E	1200210	Ex9PBW3463E	1200250	Ex9PBW3464E	1200290	Ex9PBW3465E	1200330
		Ex9PBW3561E	1200171	Ex9PBW3562E	1200211	Ex9PBW3563E	1200251	Ex9PBW3564E	1200291	Ex9PBW3565E	1200331
		Ex9PBW3661E	1200172	Ex9PBW3662E	1200212	Ex9PBW3663E	1200252	Ex9PBW3664E	1200292	Ex9PBW3665E	1200332
○ ● ● ● ●	48	Ex9PBW3161F	1200173	Ex9PBW3162F	1200213	Ex9PBW3163F	1200253	Ex9PBW3164F	1200293	Ex9PBW3165F	1200333
		Ex9PBW3361F	1200174	Ex9PBW3362F	1200214	Ex9PBW3363F	1200254	Ex9PBW3364F	1200294	Ex9PBW3365F	1200334
		Ex9PBW3461F	1200175	Ex9PBW3462F	1200215	Ex9PBW3463F	1200255	Ex9PBW3464F	1200295	Ex9PBW3465F	1200335
		Ex9PBW3561F	1200176	Ex9PBW3562F	1200216	Ex9PBW3563F	1200256	Ex9PBW3564F	1200296	Ex9PBW3565F	1200336
		Ex9PBW3661F	1200177	Ex9PBW3662F	1200217	Ex9PBW3663F	1200257	Ex9PBW3664F	1200297	Ex9PBW3665F	1200337
○ ● ● ● ●	110	Ex9PBW3161N	1200178	Ex9PBW3162N	1200218	Ex9PBW3163N	1200258	Ex9PBW3164N	1200298	Ex9PBW3165N	1200338
		Ex9PBW3361N	1200179	Ex9PBW3362N	1200219	Ex9PBW3363N	1200259	Ex9PBW3364N	1200299	Ex9PBW3365N	1200339
		Ex9PBW3461N	1200180	Ex9PBW3462N	1200220	Ex9PBW3463N	1200260	Ex9PBW3464N	1200300	Ex9PBW3465N	1200340
		Ex9PBW3561N	1200181	Ex9PBW3562N	1200221	Ex9PBW3563N	1200261	Ex9PBW3564N	1200301	Ex9PBW3565N	1200341
		Ex9PBW3661N	1200182	Ex9PBW3662N	1200222	Ex9PBW3663N	1200262	Ex9PBW3664N	1200302	Ex9PBW3665N	1200342
○ ● ● ● ●	230	Ex9PBW3161H	1200183	Ex9PBW3162H	1200223	Ex9PBW3163H	1200263	Ex9PBW3164H	1200303	Ex9PBW3165H	1200343
		Ex9PBW3361H	1200184	Ex9PBW3362H	1200224	Ex9PBW3363H	1200264	Ex9PBW3364H	1200304	Ex9PBW3365H	1200344
		Ex9PBW3461H	1200185	Ex9PBW3462H	1200225	Ex9PBW3463H	1200265	Ex9PBW3464H	1200305	Ex9PBW3465H	1200345
		Ex9PBW3561H	1200186	Ex9PBW3562H	1200226	Ex9PBW3563H	1200266	Ex9PBW3564H	1200306	Ex9PBW3565H	1200346
		Ex9PBW3661H	1200187	Ex9PBW3662H	1200227	Ex9PBW3663H	1200267	Ex9PBW3664H	1200307	Ex9PBW3665H	1200347

Specifications ..... B13

Dimensions ..... B23

Accessories ..... C26 to 33



# 22 mm Pushbuttons

## Ex9PBV6 and Ex9PBW8 Illuminated



**Certifications**  
IEC/EN 60947-5-1

CE cRU US



B

### Indicator Light

Color	LED Lamp Voltage Vac/dc	Product	Part Number
		1NO+1NC	
○ ● ● ● ●	6	Ex9PBV61A	1200463
		Ex9PBV63A	1200464
		Ex9PBV64A	1200465
		Ex9PBV65A	1200466
		Ex9PBV66A	1200467
○ ● ● ● ●	12	Ex9PBV61C	1200468
		Ex9PBV63C	1200469
		Ex9PBV64C	1200470
		Ex9PBV65C	1200471
		Ex9PBV66C	1200472
○ ● ● ● ●	24	Ex9PBV61D	1200473
		Ex9PBV63D	1200474
		Ex9PBV64D	1200475
		Ex9PBV65D	1200476
		Ex9PBV66D	1200477
○ ● ● ● ●	36	Ex9PBV61E	1200478
		Ex9PBV63E	1200479
		Ex9PBV64E	1200480
		Ex9PBV65E	1200481
		Ex9PBV66E	1200482
○ ● ● ● ●	48	Ex9PBV61F	1200483
		Ex9PBV63F	1200484
		Ex9PBV64F	1200485
		Ex9PBV65F	1200486
		Ex9PBV66F	1200487
○ ● ● ● ●	110	Ex9PBV61N	1200488
		Ex9PBV63N	1200489
		Ex9PBV64N	1200490
		Ex9PBV65N	1200491
		Ex9PBV66N	1200492
○ ● ● ● ●	230	Ex9PBV61H	1200493
		Ex9PBV63H	1200494
		Ex9PBV64H	1200495
		Ex9PBV65H	1200496
		Ex9PBV66H	1200497

### Momentary Double Head - Flush+Projecting

Color	Contacts	Product	Part Number
		1NO+1NC	
● + ●	6	Ex9PBW8465A	1200441
	12	Ex9PBW8465C	1200442
	24	Ex9PBW8465D	1200443
	36	Ex9PBW8465E	1200444
	48	Ex9PBW8465F	1200445
	110	Ex9PBW8465N	1200446
	230	Ex9PBW8465H	1200447

## 22 mm Pushbuttons

### Ex9PB Dimensions

#### Ex9PBA

Momentary Flush

Unit: in [mm]

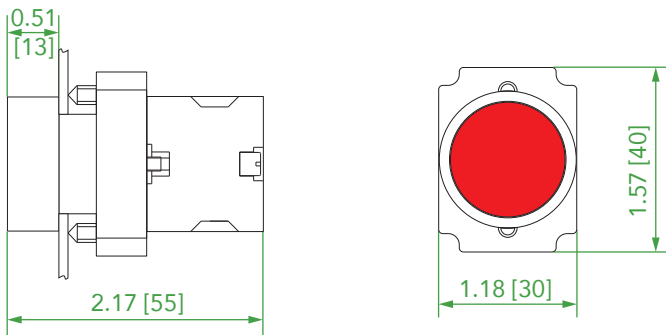

#### Ex9PBC/Ex9PBR

Momentary  $\varnothing 40$  or  $\varnothing 60$  mm Mushroom Head

Unit: in [mm]

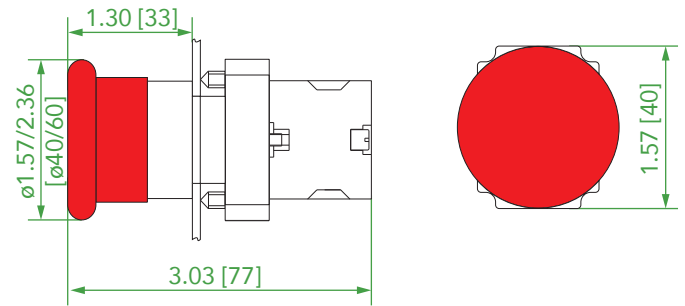

#### Ex9PBA+Symbol

Momentary Flush+Symbol

Unit: in [mm]

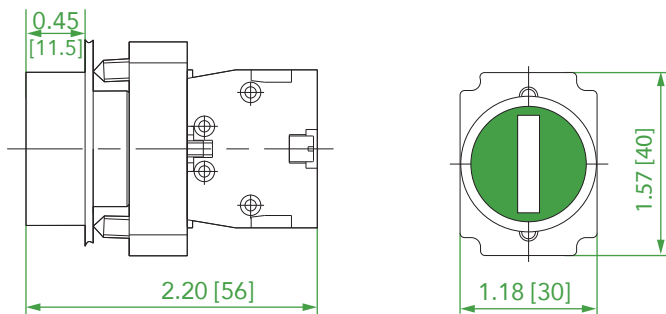

#### Ex9PBS

Push On/Twist Off  $\varnothing 30$  mm Mushroom Head

Unit: in [mm]

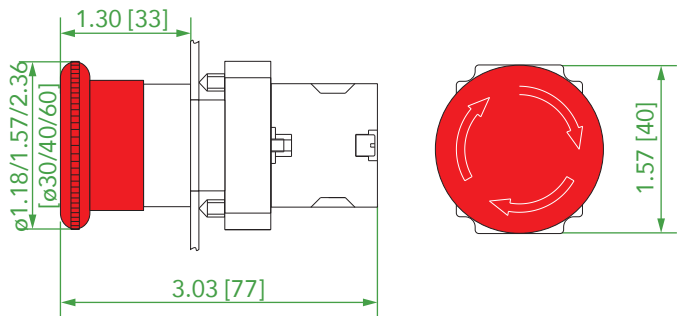

#### Ex9PBL

Momentary Extended

Unit: in [mm]

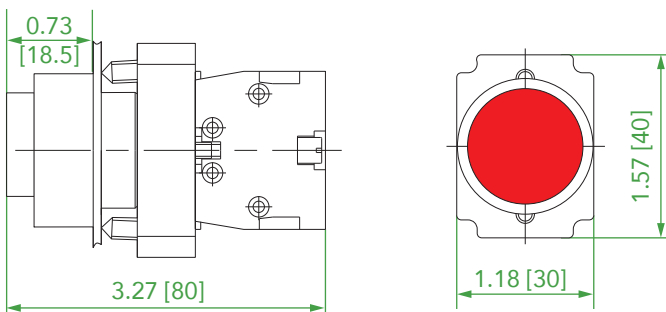

#### Ex9PBL8

Momentary Double Head Flush or Extended

Unit: in [mm]

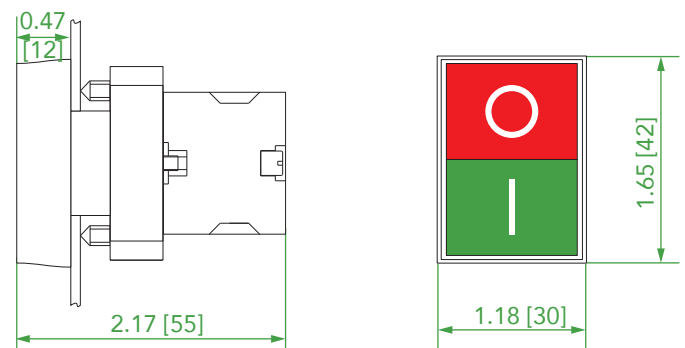

# 22 mm Pushbuttons

## Ex9PB Dimensions

### Ex9PBD

Selector Switch - Rotary Knob

Unit: in [mm]

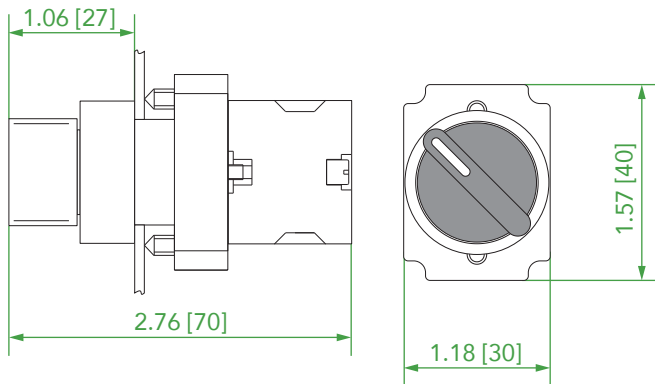

### Ex9PBW3

Momentary Flush with Guard

Unit: in [mm]

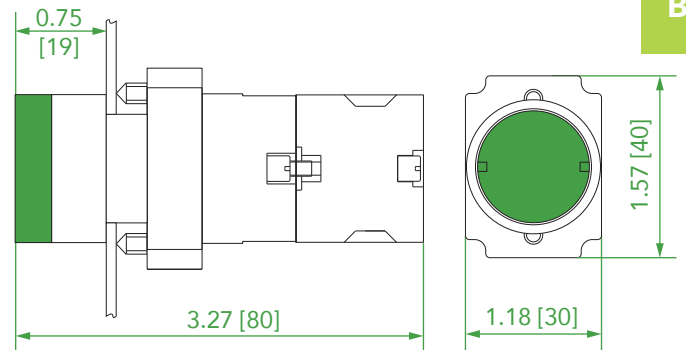

B

### Ex9PBJ

Selector Switch - Rotary Handle

Unit: in [mm]

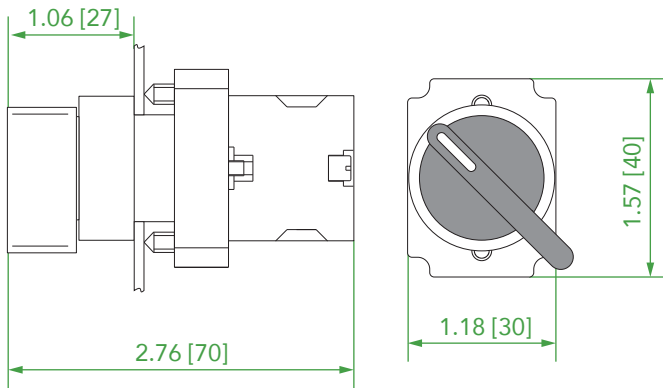

### Ex9PBV6

Indicator Light

Unit: in [mm]

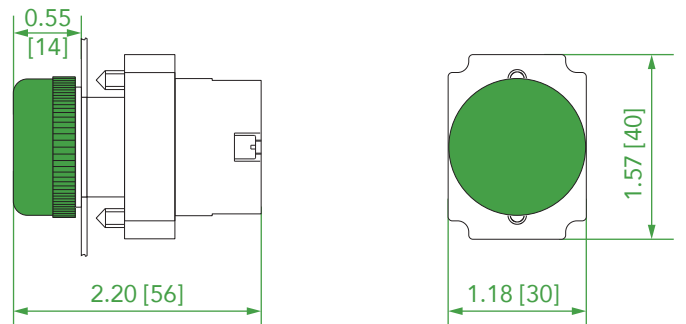

### Ex9PBG

Selector Switch - Key

Unit: in [mm]

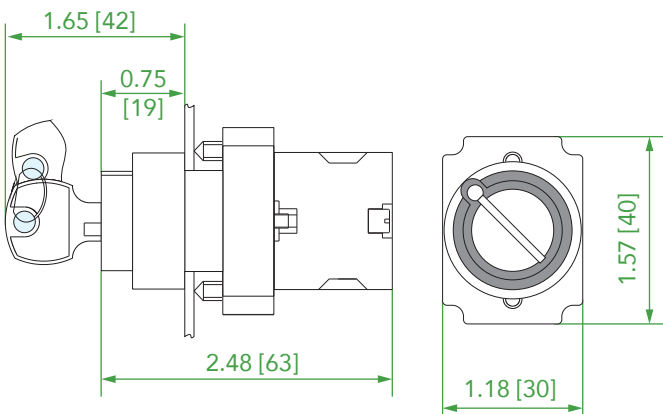

### Ex9PBW8

Momentary Double Head - Flush+Projecting

Unit: in [mm]

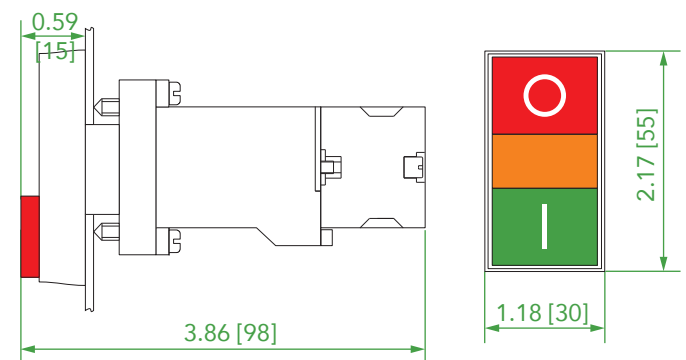

# PUSHBUTTON ACCESSORIES



## 22 mm Pushbuttons Accessories Overview

# Replacement Heads



Non-Illuminated  
Momentary Flush Head



Non-Illuminated  
ø40/60 mm Mushroom Head



Non-Illuminated  
ø30/40/60 mm Mushroom Head



Non-Illuminated  
Flush Double Head



Non-Illuminated  
Flush+Projecting Double Head



Non-Illuminated Selector  
Switch Rotary Knob Head



Non-Illuminated Selector  
Switch Rotary Key Head



Illuminated Momentary Flush  
with Guard Head



Illuminated  
Flush+Projecting Double Head



Illuminated  
Indicator Light Head

# Accessories



Middle Adapter



ø60 mm Warning Label



ø90 mm Warning Label



Name Plate



Waterproof Head Enclosure



Waterproof Head Enclosure



Waterproof Head Enclosure



Waterproof Head Enclosure

# Contacts, Lamps & Enclosures



Contact Blocks



LED Lamp  
Replacements



Enclosures

## 22 mm Pushbuttons

### Ex9PB Replacement Heads: Non-Illuminated



Accessory Description	Color	Product	Part Number
Non-Illuminated Momentary Flush Replacement Head	○	Ex9PBA1	1200559
	●	Ex9PBA2	1200560
	●	Ex9PBA3	1200561
	●	Ex9PBA4	1200562
	●	Ex9PBA5	1200563
	●	Ex9PBA6	1200564



Accessory Description	Color	Product	Part Number	Product	Part Number
		ø40 mm		ø60 mm	
Non-Illuminated Mushroom Replacement Head	○	Ex9PBC1	1200764	Ex9PBR1	1200770
	●	Ex9PBC2	1200765	Ex9PBR2	1200771
	●	Ex9PBC3	1200766	Ex9PBR3	1200772
	●	Ex9PBC4	1200767	Ex9PBR4	1200773
	●	Ex9PBC5	1200768	Ex9PBR5	1200774
	●	Ex9PBC6	1200769	Ex9PBR6	1200775



Accessory Description	Color	Product	Part Number
		ø30 mm	
Non-Illuminated Mushroom Push On/Twist Off Replacement Head (Self Locking)	●	Ex9PBS44	1200776
		ø40 mm	
		Ex9PBS54	1200777
		ø60 mm	
Ex9PBS64	1200778		



Accessory Description	Color	Product	Part Number
Non-Illuminated Flush Double Replacement Head	● + ●	Ex9PBL832	1200570







Accessory Description	Color	Product	Part Number
Non-Illuminated Flush+Projecting Double Replacement Head	● + ●	Ex9PBL842	1200571

# 22 mm Pushbuttons



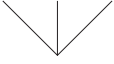

## Ex9PB Replacement Heads: Non-Illuminated



Accessory Description	Positions	Product	Part Number	
		2-Position		
Non-Illuminated Selector Switch - Rotary Knob Replacement Head	Locking 	Ex9PBD2	1200578	
	Reset 	Ex9PBD4	1200580	
	3-Position			
	Locking 	Ex9PBD3	1200579	
	Reset 	Ex9PBD5	1200581	

C

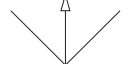

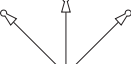
Accessory Description	Positions	Product	Part Number	
		2-Position		
Non-Illuminated Selector Switch - Key Replacement Head	1-Locking 	Ex9PBG2	1200582	
	Reset 	Ex9PBG4	1200586	
	2-Locking 	Ex9PBG2B	1200583	
	3-Position			
	Middle Locking 	Ex9PBG3	1200584	
	Reset 	Ex9PBG5	1200587	
3-Locking 	Ex9PBG3D	1200585		

 = Key removed at this position only.

## 22 mm Pushbuttons

### Ex9PB Replacement Heads: Illuminated



Accessory Description	Color	Product	Part Number
Illuminated LED Momentary Flush Replacement Head	○	Ex9PBW31	1200565
	●	Ex9PBW33	1200566
	●	Ex9PBW34	1200567
	●	Ex9PBW35	1200568
	●	Ex9PBW36	1200569



Accessory Description	Color	Product	Part Number
Illuminated LED Flush+Projecting Double Replacement Head	● + ●	Ex9PBW84	1200572



Accessory Description	Color	Product	Part Number
Illuminated LED Indicator Light Replacement Head	○	Ex9PBV/1	1200573
	●	Ex9PBV/3	1200574
	●	Ex9PBV/4	1200575
	●	Ex9PBV/5	1200576
	●	Ex9PBV/6	1200577



# 22 mm Pushbuttons

## Ex9PB Accessories

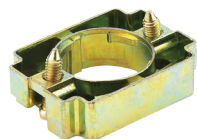

Accessory Description	Color	Product	Part Number
Middle Adapter	Metal	Ex9PBZ009	1200588



Accessory Description	Imprint	Product	Part Number
Warning Label ø60 mm	Blank	Ex9PBY9101	1200589
	Printed	Ex9PBY9330	1200590



Accessory Description	Imprint	Product	Part Number
Warning Label ø90 mm	Blank	Ex9PBY8101	1200591
	Printed	Ex9PBY8330	1200592



Accessory Description	Size	Product	Part Number
Name Plate HxL in (mm)	1,18 x 1,77 (30 x 45)	Ex9PBZ31	1200593



Accessory Description	Compatible With	Product	Part Number
Waterproof Head Enclosure	Ex9PBP	Ex9PBPF	1200594



Accessory Description	Compatible With	Product	Part Number
Waterproof Head Enclosure	Ex9PBA	Ex9PBAF	1200595



Accessory Description	Compatible With	Product	Part Number
Waterproof Head Enclosure	Ex9PBL832	Ex9PBL832F	1200596



Accessory Description	Compatible With	Product	Part Number
Waterproof Head Enclosure	Ex9PBL842	Ex9PBL842F	1200597

## 22 mm Pushbuttons

### Ex9PB Contact Blocks and LED Lamp Replacements





























Accessory Description	Poles	Product	Part Number
Contact Block	NO	Ex9PBE101	1200598

Accessory Description	Poles	Product	Part Number
Contact Block	NC	Ex9PBE102	1200599

Accessory Description	Color	Voltage Vac/dc	Product	Part Number
LED Lamp Replacement	○	6	Ex9PBS1A	1200600
	●		Ex9PBS3A	1200601
	●		Ex9PBS4A	1200602
	●		Ex9PBS5A	1200603
	●		Ex9PBS6A	1200604
	○		12	Ex9PBS1C
	●	Ex9PBS3C		1200606
	●	Ex9PBS4C		1200607
	●	Ex9PBS5C		1200608
	●	Ex9PBS6C		1200609
	○	24		Ex9PBS1D
	●		Ex9PBS3D	1200611
	●		Ex9PBS4D	1200612
	●		Ex9PBS5D	1200613
	●		Ex9PBS6D	1200614
	○		36	Ex9PBS1E
	●	Ex9PBS3E		1200616
	●	Ex9PBS4E		1200617
	●	Ex9PBS5E		1200618
	●	Ex9PBS6E		1200619
	○	48		Ex9PBS1F
	●		Ex9PBS3F	1200621
	●		Ex9PBS4F	1200622
	●		Ex9PBS5F	1200623
●	Ex9PBS6F		1200624	
○	110/120		Ex9PBS1N	1200625
●		Ex9PBS3N	1200626	
●		Ex9PBS4N	1200627	
●		Ex9PBS5N	1200628	
●		Ex9PBS6N	1200629	
○		230/240	Ex9PBS1H	1200630
●	Ex9PBS3H		1200631	
●	Ex9PBS4H		1200632	
●	Ex9PBS5H		1200633	
●	Ex9PBS6H		1200634	

# 22 mm Pushbuttons

## Ex9PB Enclosures

	Accessory Description	Product	Part Number		Accessory Description	Product	Part Number
	Enclosure 1-Hole <i>(Pushbuttons not included)</i>	Ex9PB01	1200635		Enclosure Start/Stop <i>(Pushbuttons included)</i>	Ex9PB211H29	1200650
	Enclosure 2-Hole <i>(Pushbuttons not included)</i>	Ex9PB02	1200636		Enclosure Start/Stop <i>(Pushbuttons included)</i>	Ex9PB213	1200651
	Enclosure 3-Hole <i>(Pushbuttons not included)</i>	Ex9PB03	1200637		Enclosure Start/Stop <i>(Pushbuttons included)</i>	Ex9PB215	1200652
	Enclosure Start <i>(Pushbuttons included)</i>	Ex9PB101H29	1200639		Enclosure Up/Down <i>(Pushbuttons included)</i>	Ex9PB222	1200653
	Enclosure Start <i>(Pushbuttons included)</i>	Ex9PB102	1200640		Enclosure Right/Left <i>(Pushbuttons included)</i>	Ex9PB223	1200654
	Enclosure Start <i>(Pushbuttons included)</i>	Ex9PB103	1200641		Enclosure Forward/Stop/Reverse <i>(Pushbuttons included)</i>	Ex9PB311H29	1200655
	Enclosure Stop <i>(Pushbuttons included)</i>	Ex9PB111H29	1200642		Enclosure Up/Stop/Down <i>(Pushbuttons included)</i>	Ex9PB321H29	1200656
	Enclosure Stop <i>(Pushbuttons included)</i>	Ex9PB112	1200643		Enclosure Up/Stop/Down <i>(Pushbuttons included)</i>	Ex9PB324	1200657
	Enclosure Stop <i>(Pushbuttons included)</i>	Ex9PB114	1200644		Enclosure Right/Stop/Left <i>(Pushbuttons included)</i>	Ex9PB334	1200658
	Enclosure Stop/Start Rotary Handle <i>(Pushbuttons included)</i>	Ex9PB132H29	1200645		Enclosure Start/Stop/Pause <i>(Pushbuttons included)</i>	Ex9PB339	1200659
	Enclosure Stop/Start Rotary Key <i>(Pushbuttons included)</i>	Ex9PB142H29	1200646		Enclosure Close/Stop/Open <i>(Pushbuttons included)</i>	Ex9PB341H29	1200660
	Enclosure Emergency Stop <i>(Pushbuttons included)</i>	Ex9PB164H29	1200647		Enclosure Indicator Light/Start/Stop <i>(Pushbuttons included)</i>	Ex9PB361H29	1200661
					Enclosure Indicator Light/Start/Stop <i>(Pushbuttons included)</i>	Ex9PB363	1200662
					Enclosure Indicator Light/Start/Stop <i>(Pushbuttons included)</i>	Ex9PB366	1200663

Dimensions..... C32 to 33  
All enclosures IP 40.

C

## 22 mm Pushbuttons

### Ex9PB Enclosure Dimensions

#### Enclosure with 1-Hole

Unit: in [mm]

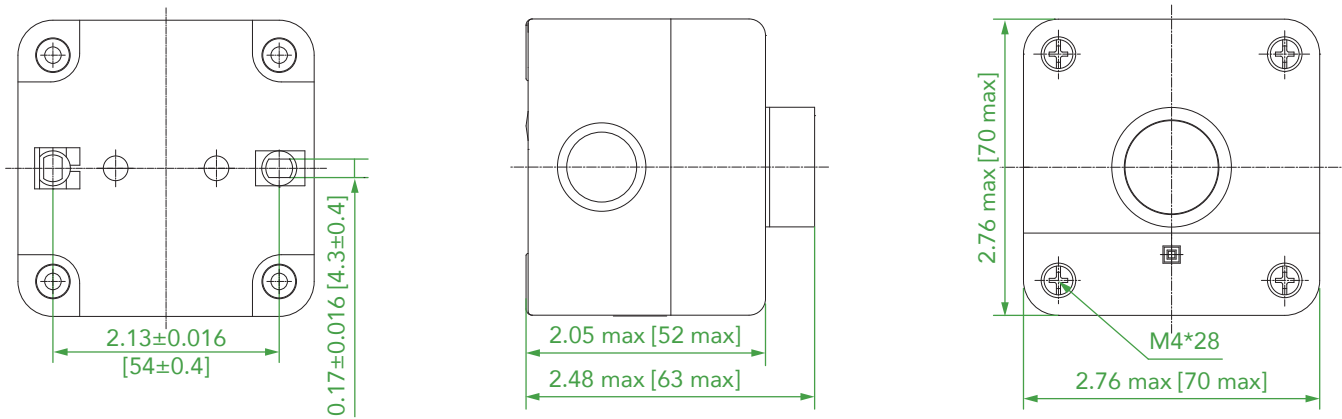

#### Enclosure with 2-Holes

Unit: in [mm]

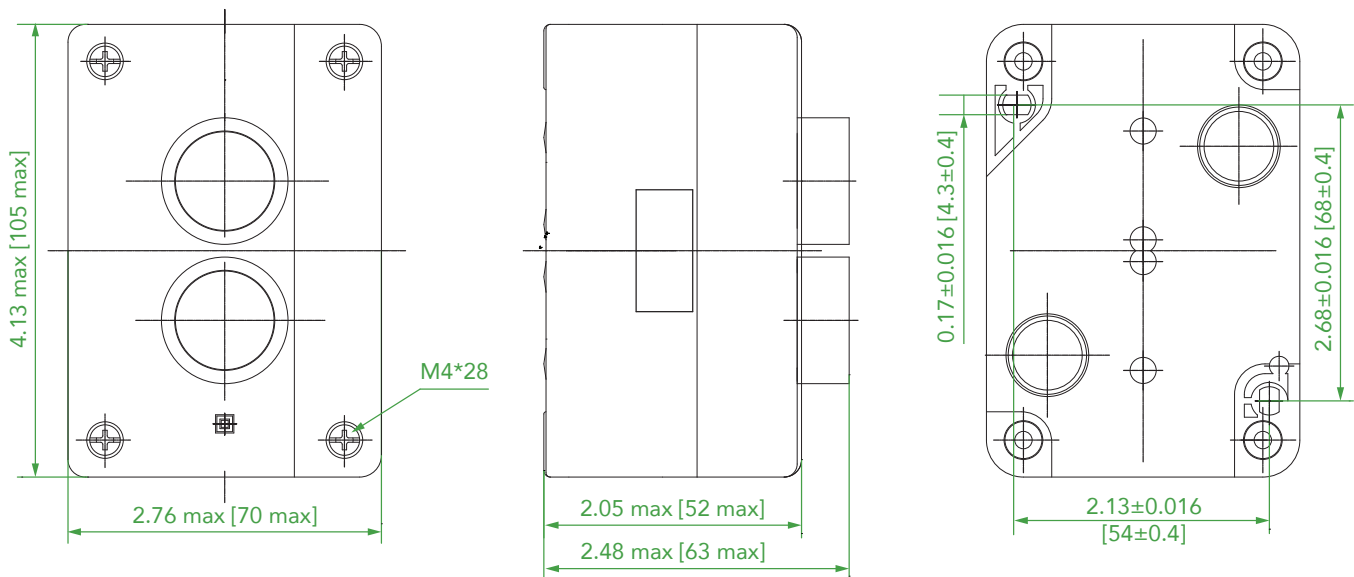

# 22 mm Pushbuttons

## Ex9PB Enclosure Dimensions

### Enclosure with 3-Holes

Unit: in [mm]

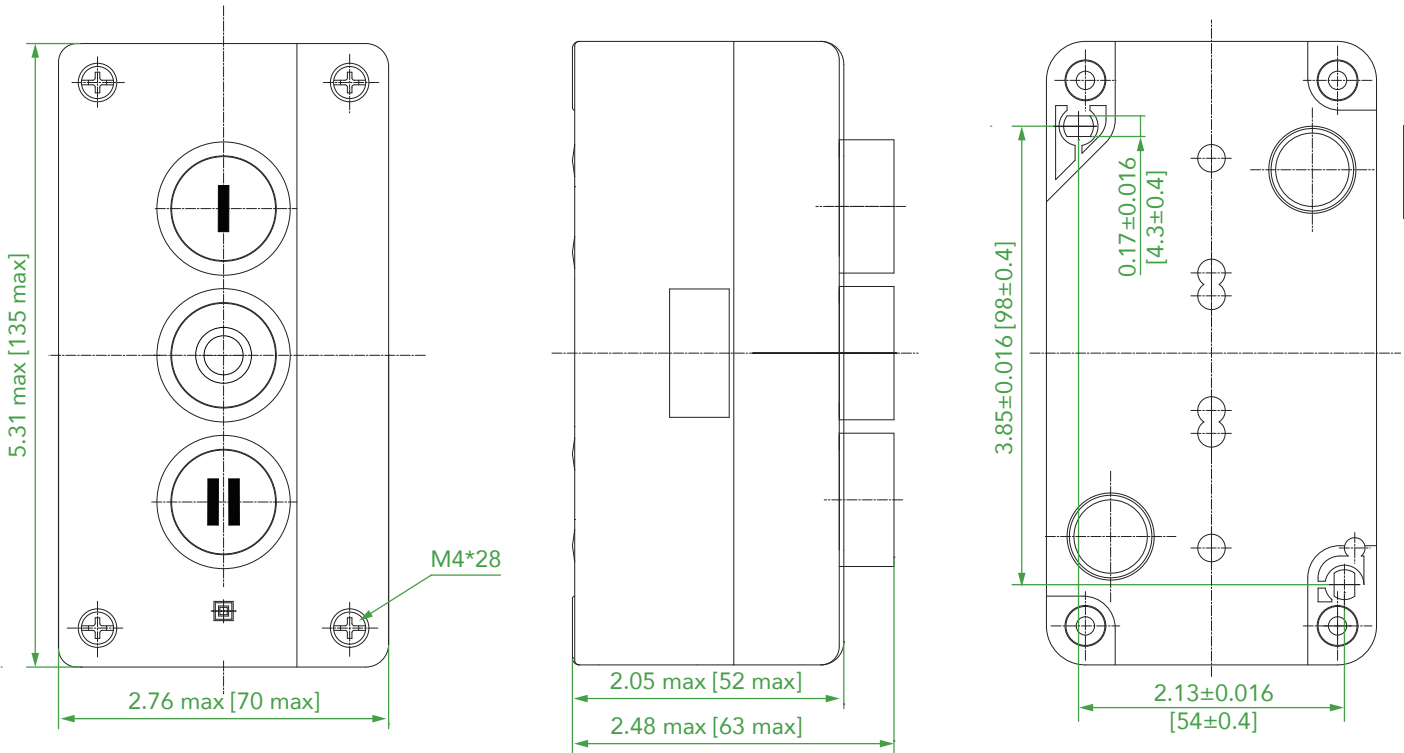

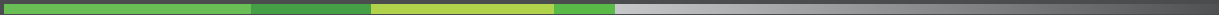



# NOARK®



**NOARK Electric North America**

(626) 330-7007

na.noark-electric.com • nasales@noark-electric.com



**Note:** NOARK Electric reserves the right to make technical changes or modify the contents of this document without prior notice. With regard to purchase orders, the agreed particulars shall prevail. NOARK Electric does not accept any responsibility whatsoever for potential errors or possible lack of information in this document. NOARK Electric reserves all rights in this document and in the subject matter and illustrations contained therein. Any reproduction, disclosure to third parties or utilization of its contents – in whole or in parts – is forbidden without prior written consent of NOARK Electric.