



Installation Guide

Single Phase Inverter with HD-Wave Technology

For Europe and APAC

Version 1.4

Disclaimers

Important Notice

Copyright © SolarEdge Inc. All rights reserved.

No part of this document may be reproduced, stored in a retrieval system or transmitted, in any form or by any means, electronic, mechanical, photographic, magnetic or otherwise, without the prior written permission of SolarEdge Inc.

The material furnished in this document is believed to be accurate and reliable. However, SolarEdge assumes no responsibility for the use of this material. SolarEdge reserves the right to make changes to the material at any time and without notice. You may refer to the SolarEdge web site (www.solaredge.com) for the most updated version.

All company and brand products and service names are trademarks or registered trademarks of their respective holders.

Patent marking notice: see <http://www.solaredge.com/patent>

The general terms and conditions of delivery of SolarEdge shall apply.

The content of these documents is continually reviewed and amended, where necessary. However, discrepancies cannot be excluded. No guarantee is made for the completeness of these documents.

The images contained in this document are for illustrative purposes only and may vary depending on product models.

Emission Compliance

This equipment has been tested and found to comply with the limits applied by the local regulations.

These limits are designed to provide reasonable protection against harmful interference. This equipment generates, uses and can radiate radio frequency energy and, if not installed and used in accordance with the instructions, may cause harmful interference to radio communications. However, there is no guarantee that interference will not occur in a particular installation. If this equipment does cause harmful interference to radio or television reception, which can be determined by turning the equipment off and on, you are encouraged to try to correct the interference by one or more of the following measures:

- Reorient or relocate the receiving antenna.
- Increase the separation between the equipment and the receiver.
- Connect the equipment into an outlet on a circuit different from that to which the receiver is connected.
- Consult the dealer or an experienced radio/TV technician for help.

Changes or modifications not expressly approved by the party responsible for compliance may void the user's authority to operate the equipment.

NOTE



Interference may occur when the Wi-Fi Plug-in and Repeater are installed near other 2.4 GHz emitting devices (such as dual technology PIR detectors used in alarm systems, microwave ovens, etc.). This might degrade/ disable the gateway/ repeater operation. If possible, avoid installation nearby such devices, or consider these interferences when troubleshooting.

CAUTION!

Where EN55011 Class A is deemed applicable, the following requirements apply:

- This equipment is not intended for use in residential environments and may not provide adequate protection to radio reception in such environments.
- ▲ ■ This equipment should be connected to inverters with a rated power > 20 kVA and is intended to be installed in a large photovoltaic power generating system by a professional.
- This equipment should be physically separated from residential environments by a distance greater than 30 m, and can be equipped with additional filtering if necessary.

Simplified EU Declaration of Conformity

SolarEdge Technologies Ltd. hereby declares that its Wireless Communication, Wi-Fi/ZigBee radio equipment is in compliance with Directive 2014/53/EU.

The full text of the EU declaration of conformity is available at:

<https://www.solaredge.com/sites/default/files/se-single-phase-inverter-certificate-ce-conformity.pdf>.

Revision History

Version 1.4 (November 2021)

- Updated the "Installing the Power Optimizers" on page 13 to include the S-Series Power Optimizers.
- Added the part number and extension cable length for S-Series Power Optimizers in "Installation Guidelines" on page 15.
- Added an Image comparing the S-Series Power Optimizer to the P-Series Power Optimizer in "Step 2: Connecting a PV module to a Power Optimizer" on page 17.
- Indicated how to connect S-Series Power Optimizers to each other in strings in "Step 3: Connecting Power Optimizers in Strings" on page 18.

Version 1.3 (July 2021)

- Updated strip length of the internal wire insulation in *Connecting the AC Grid to the Inverter* on page 29
- Added translations of Handling and Safety instructions
- Added Communication Board specifications
- Updated the Optimizer Installation Guidelines in *Installation Guidelines* on page 15.
- Added a requirement to minimize the distance between the positive and negative DC optimizer cables in *Step 3: Connecting Power Optimizers in Strings* on page 18.
- Added the requirement for a special bracket, when installing close to the shoreline in *Mounting the Inverter* on page 25
- Updated the communication board TCP details in *Creating an Ethernet (LAN) Connection* on page 43.
- Changed the cable type required for the RS485 and Ethernet connection to CAT6.

Contents

Disclaimers	1
Important Notice	1
Emission Compliance	2
Simplified EU Declaration of Conformity	3
Revision History	4
HANDLING AND SAFETY INSTRUCTIONS	7
Safety Symbols Information	7
IMPORTANT SAFETY INSTRUCTIONS	8
Chapter 1: Introducing the SolarEdge Power Harvesting System	10
Power Optimizer	10
SolarEdge Inverter	10
Monitoring Platform	11
Designer	11
Installation Equipment List	11
Inverter Transport and Storage	12
Chapter 2: Installing the Power Optimizers	13
Safety	13
Installation Guidelines	15
Step 1: Mounting the Power Optimizers	17
Step 2: Connecting a PV module to a Power Optimizer	17
Step 3: Connecting Power Optimizers in Strings	18
Step 4: Verifying Proper Power Optimizer Connection	19
Chapter 3: Installing the Inverter	21
Inverter Package Contents	21
Identifying the Inverter	21
Inverter Interfaces	22
Mounting the Inverter	25
Chapter 4: Connecting Grid and PV Strings to the Inverter	29
Connecting the AC Grid to the Inverter	29
Connecting the Strings to the Inverter	30
Selecting a Residual Current Device (RCD)	31
Chapter 5: Activating, Commissioning and Configuring the System	33
Step 1: Activating the Installation	33
Step 2: Commissioning and Configuring the Installation	34
Step 3: Verifying Proper Activation and Commissioning	36
Reporting and Monitoring Installation Data	36
Chapter 6: Setting Up Communication with the Monitoring Platform	39

Communication Options	39
Communication Connectors	41
Removing the Inverter Cover	42
Removing the DC Safety Unit Cover (if applicable)	42
Creating an Ethernet (LAN) Connection	43
Creating RS485 Bus Connection	46
RS485 Bus Configuration	49
Verifying the Connection	49
Appendix A: Errors and Troubleshooting	50
Identifying Errors	50
Troubleshooting Communication	51
Power Optimizer Troubleshooting	53
Appendix B: Mechanical Specifications	55
Appendix C: Maintenance and System Components Replacement	56
Replacing an Inverter	56
Replacing the DC Safety Unit	58
Adding, Removing, or Replacing Power Optimizers	59
Appendix D: SafeDC™	61
Technical Specifications - Single Phase Inverters with HD-Wave Technology (Europe & APAC)	62
Technical Specifications - Single Phase Inverters with HD-Wave Technology (Europe & APAC)	66
Technical Specifications - Single Phase Inverters with HD-Wave Technology (Australia)	69
Communication Board - Technical Specifications	73
Support Contact Information	74

HANDLING AND SAFETY INSTRUCTIONS

Safety Symbols Information

The following safety symbols are used in this document. Familiarize yourself with the symbols and their meaning before installing or operating the system.

WARNING!



Denotes a hazard. It calls attention to a procedure that, if not correctly performed or adhered to, could result in **injury or loss of life**. Do not proceed beyond a warning note until the indicated conditions are fully understood and met.

CAUTION!



Denotes a hazard. It calls attention to a procedure that, if not correctly performed or adhered to, could result in **damage or destruction of the product**. Do not proceed beyond a caution sign until the indicated conditions are fully understood and met.



NOTE

Denotes additional information about the current subject.



IMPORTANT SAFETY FEATURE

Denotes information about safety issues.

Disposal requirements under the Waste Electrical and Electronic Equipment (WEEE) regulations:



NOTE

Discard this product according to local regulations or send it back to SolarEdge.

IMPORTANT SAFETY INSTRUCTIONS

SAVE THESE INSTRUCTIONS



Warning!

To reduce the risk of injury, read all instructions in this document.

WARNING!



The inverter cover must be opened only after switching the inverter ON/OFF/P switch located at the bottom of the inverter to OFF. This disables the DC voltage inside the inverter. Wait five minutes before opening the cover. Otherwise, there is a risk of electric shock from energy stored in the capacitors.

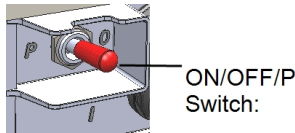

WARNING!



Before operating the inverter, ensure that the inverter AC power cable and wall outlet are grounded properly. This product must be connected to a grounded, metal, permanent wiring system, or an equipment-grounding conductor must be run with the circuit conductors and connected to the equipment grounding terminal or lead on the product.

WARNING!



Opening the inverter and repairing or testing under power must be performed only by qualified service personnel familiar with this inverter.

WARNING!



Do not touch the PV panels or any rail system connected when the inverter switch is ON, unless grounded.

WARNING!

SafeDC complies with IEC60947-3 when installing the system with a worst case SafeDC voltage (under fault conditions) < 120V.



The worst case voltage is defined as: $V_{oc,max} + (\text{String Length} - 1) * 1V$, where:

$V_{oc,max}$ = Maximum Voc (at lowest temperature) of the PV modules in the string (for a string with multiple modules, use the max value)

- String Length = number of power optimizers in the string



CAUTION!



This unit must be operated according to the technical specification datasheet provided with the unit.

 **CAUTION!**
HEAVY OBJECT. To avoid muscle strain or back injury, use proper lifting techniques, and if required - a lifting aid.

 **NOTE**
 Use PV modules rated according to IEC 61730 class A.

 **NOTE**
 The symbol  appears at grounding points on the SolarEdge equipment. This symbol is also used in this manual.



 **NOTE**
 SolarEdge inverters can be installed in sites with an alternative power source such as a generator. SolarEdge requires installing a physical or electronic interlock, which will signal to the inverter when the grid has been disconnected. Interlock procurement, installation, maintenance and support are the responsibility of the installer. Damage to the inverter due to incorrect interlock installation or use of an interlock that is incompatible with the SolarEdge system will render the SolarEdge warranty invalid.

For more information on connecting an alternative power source to SolarEdge inverter, refer to <https://www.solaredge.com/sites/default/files/se-inverter-support-of-voltage-sources.pdf>.



NOTE
 The following warning symbols appear on the inverter warning label:

 Risk of electric shock

   Risk of electric shock from energy stored in the capacitor. Do not remove cover until 5 minutes after disconnecting all sources of supply.

 Hot surface – To reduce the risk of burns, do not touch.

 Caution, risk of danger

Chapter 1: Introducing the SolarEdge Power Harvesting System

The SolarEdge power harvesting solution maximizes the power output from any type of solar photovoltaic (PV) installation while reducing the average cost per watt. The following sections describe each of the system's components.

Power Optimizer

The Power Optimizers are DC-DC converters connected to PV modules to maximize power harvesting by performing independent Maximum Power Point Tracking (MPPT) at the module level.

The Power Optimizers regulate the PV string voltage at a constant level, regardless of PV string length and environmental conditions.

The Power Optimizers include a safety Voltage function that automatically reduces the output of each Power Optimizer to 1 Vdc in the following cases:

- During fault conditions
- The Power Optimizers are disconnected from the inverter
- The inverter ON/OFF/P switch is turned OFF
- The inverter AC breaker is turned OFF
- The Rapid Shutdown (PVRSS) is initiated by one of the following methods:
 - Inverter AC breaker is turned OFF, or AC to the inverter is disconnected by another method (intentionally or as result of a fault)

Each Power Optimizer also transmits module performance data over the DC power line to the inverter.

Two types of Power Optimizers are available:

- Module add-on Power Optimizer – connected to one or more modules
- Smart modules - the Power Optimizer is embedded into a module

SolarEdge Inverter

The SolarEdge inverter efficiently converts DC power from the modules into AC power that can be fed into the main AC service of the site and from there to the grid. The inverter also receives the monitoring data from each power optimizer and transmits it to a central server (the SolarEdge monitoring platform; requires Internet connection).

Monitoring Platform

The monitoring platform enables monitoring the technical and financial performance of one or more SolarEdge sites. It provides past and online information on the system performance, both at the system and PV module levels.

Designer

Designer recommends inverter and Power Optimizer selection per site size and enables report generation. You can create a project in Designer and export the site design with the PV array layout to the monitoring platform.

Installation Equipment List

Standard tools can be used during the installation of the SolarEdge system. The following is a recommendation of the equipment needed for installation:

- Allen screwdriver for 4 mm screw type for the inverter cover, side screws, and DC Safety Unit cover (if applicable)
- Standard flat-head screwdrivers set
- Non-contact voltage detector
- Cordless drill (with a torque clutch) or screwdriver and bits suitable for the surface on which the inverter and optimizers will be installed. Use of an impact driver is *not* allowed.
- Appropriate mounting hardware (for example: stainless bolts, nuts, and washers) for attaching:
 - the inverter mounting bracket to the mounting surface
 - the power optimizer to the racking (not required for smart modules)
- MC4 crimper (if applicable)
- Wire cutters
- Wire strippers
- Voltmeter
- Mobile phone with latest SetApp version

For installing the communication options, you may also need the following:

- For Ethernet:
 - CAT6 twisted pair Ethernet cable with RJ45 connector
 - If using a CAT6 cable spool: RJ45 plug and RJ45 crimper

- For RS485 :
 - Four- or six-wire shielded twisted pair cable
 - Watchmaker precision screwdriver set

Inverter Transport and Storage

Transport the inverter in its original packaging, facing up and without exposing it to unnecessary shocks. If the original package is no longer available, use a similar box that can withstand the weight of the inverter (refer to the inverter weight in the specification datasheet provided with the unit), has a handle system and can be closed fully.

Store the inverter in a dry place where ambient temperatures are -25°C to $+65^{\circ}\text{C}$ / -13°F to 149°F .

Chapter 2: Installing the Power Optimizers

Safety

The following notes and warnings apply when installing the Power Optimizers. Some of the following may not be applicable to smart modules:

WARNING!



When modifying an existing installation, turn OFF the inverter ON/OFF/P switch and the AC circuit breaker on the main AC distribution panel.

CAUTION!



Power Optimizers are IP68/NEMA6P rated. Choose a mounting location where Power Optimizers will not be submerged in water.

CAUTION!



The Power Optimizer must be operated according to the technical specifications provided with the Power Optimizer.

CAUTION!



Cutting the Power Optimizer input or output cable connector is prohibited and will void the warranty.

CAUTION!



All PV modules must be connected to a Power Optimizer.

CAUTION!



If you intend to mount the Power Optimizers directly to the module or module frame, first consult the module manufacturer for guidance regarding the mounting location and the impact, if any, on module warranty. Drilling holes in the module frame should be done according to the module manufacturer instructions.

CAUTION!

Installing a SolarEdge system without ensuring compatibility of the module connectors with the Power Optimizer connectors may be unsafe and could cause functionality problems such as ground faults, resulting in inverter shut down. To ensure mechanical and electrical compatibility of the Power Optimizer connectors with the PV module connectors to which they are connected:

- Use identical connectors from the same manufacturer and of the same type on the Power Optimizers, modules and the inverter DC input; or
- Verify that the connectors are compatible in the following way:
 - The module connector manufacturer should explicitly verify compatibility with the Power Optimizer connectors and the Inverter DC input connectors.
 - A third-party test report by one of the listed external labs (TUV, VDE, Bureau Veritas UL, CSA, InterTek) should be obtained, verifying the compatibility of the connectors.

For more information, refer to

<https://www.solaredge.com/sites/default/files/optimizer-input-connector-compatibility.pdf>

**IMPORTANT SAFETY FEATURE**

Modules with SolarEdge Power Optimizers are safe. They carry only a low safety voltage before the inverter is turned ON. As long as the power optimizers are not connected to the inverter or the inverter is turned OFF, each Power Optimizer will output a safe Voltage of 1V.

Installation Guidelines

- For the minimum and maximum number of Power Optimizers in a PV string (PV string length), see the Power Optimizer datasheets. Refer to the Designer for PV string length verification. The Designer is available on the SolarEdge website at: <https://www.solaredge.com/products/installer-tools/designer#/>.

- Do not use extension cables between a module and a Power Optimizer, between two modules connected to the same Power Optimizer, or between two Power Optimizers other than in the following cases:

Between a Power Optimizer and a module:

- Extension cables of up to 1.8 m are allowed for all Power Optimizers (0.9 m for DC+, and 0.9 m for DC-).
- S-Series Power Optimizers with the 1-type suffix in their part number (Sxxx-1xxxxxx) - extension cables of up to 16 m can be installed per Power Optimizer (8 m for DC+, and 8 m for DC-).
- P-Series Power Optimizers with the 4-type suffix in their part number (Pxxx-4xxxxxx) and the Mxxx-Series - extension cables of up to 16 m can be installed per Power Optimizer (8 m for DC+, and 8 m for DC-).

Between two Power Optimizers or between a Power Optimizer and the inverter:

- Extension cables can be installed between Power Optimizers only from row to row, around obstacles or pathways within a row and from the end of the PV string to the inverter. The total length of the extension cables may not exceed the following values:

Single Phase Inverters	Three Phase Inverters
All - 300 m	SE17K and below - 300 m SE17.5K and above - 700 m

- Frame-mounted Power Optimizers are mounted directly on the module frame, regardless of racking system (rail-less or with rails). For installation of frame-mounted Power Optimizers, refer to http://www.solaredge.com/sites/default/files/installing_frame_mounted_power_optimizers.pdf.

- The Power Optimizer can be placed in any orientation.
- If connecting more modules than Power Optimizer inputs in parallel, use a branch cable. Some commercial Power Optimizer models have a dual input.

- Position the Power Optimizer close enough to its module so that their cables can be connected.
- Make sure to use Power Optimizers that have the required output and input conductor length.
- Completely shaded modules may cause their Power Optimizers to temporarily shut down. This will not affect the performance of the other Power Optimizers in the PV string, as long as the minimum number of unshaded Power Optimizers connected in a PV string of modules is met. If under typical conditions fewer than the minimum Power Optimizers are connected to unshaded modules, add more Power Optimizers to the PV string. To allow for heat dissipation, maintain clearance shown in

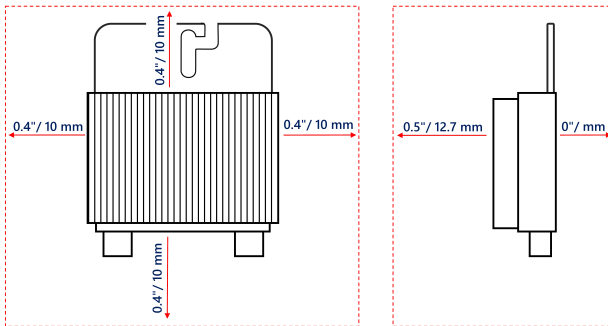



Figure 1: Power Optimizers clearance

- When installing PV modules in a confined space such as Building-integrated photovoltaic (BIPV) modules, ventilation measures may be required to ensure that the Power Optimizers are not exceeding the maximum temperatures stated in their specifications.

Step 1: Mounting the Power Optimizers

For each of the Power Optimizers⁽¹⁾:

1. Determine the Power Optimizer mounting location and use the Power Optimizer mounting brackets to attach the Power Optimizer to the support structure. It is recommended to mount the Power Optimizer in a location protected from direct sunlight. For frame-mounted Power Optimizers follow the instructions supplied with the optimizers, or refer to https://www.solaredge.com/sites/default/files/installing_frame_mounted_power_optimizers.pdf. 
2. If required, mark the mounting hole locations and drill holes.

CAUTION!



Drilling vibrations may damage the Power Optimizer and will void the warranty. Use a torque wrench or an electric drill with adjustable clutch that meets the mounting torque requirements. *Do not* use impact drivers for mounting the Power Optimizer.

Do not drill through the Power Optimizer or through the mounting holes.

3. Attach each Power Optimizer to the rack using M6 or M8 stainless steel bolts, nuts and washers or other mounting hardware. Apply torque of 9-10 N*m.
4. Verify that each Power Optimizer is securely attached to the module support structure.
5. Record Power Optimizer serial numbers and locations, as described in *Reporting and Monitoring Installation Data* on page 36.

Step 2: Connecting a PV module to a Power Optimizer

NOTE



Improper wiring may cause electrical faults in a PV system. To avoid electrical faults, verify proper locking of connectors and avoid cable tension and friction. Proper planning, materials and installation reduce the risk of electric arcs, short-circuits and ground faults in the PV system.

NOTE



Images are for illustration purposes only. Refer to the label on the product to identify the plus and minus input and output connectors.

For each of the Power Optimizers:

⁽¹⁾Not applicable to smart modules.

- Connect the Plus (+) output connector of the module to the Plus (+) input connector of the Power Optimizer.
- Connect the Minus (-) output connector of the module to the Minus (-) input connector of the Power Optimizer.

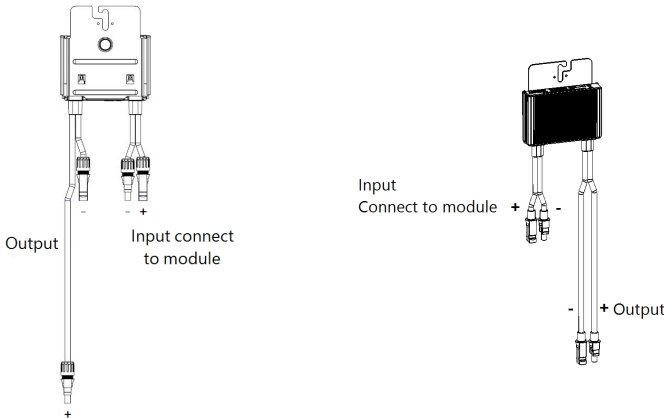

Figure 2: S-Series (left) and P-Series (right) Power Optimizer connectors

Step 3: Connecting Power Optimizers in Strings

You can construct parallel strings of unequal length, that is, the number of power optimizers in each string does not have to be the same. The minimum and maximum string lengths are specified in the power optimizer datasheets. Refer to the [Designer](#) for string length verification.



1. Connect the Minus (-) output connector of the string's first power optimizer to the Plus (+) output connector of the string's second power optimizer. When connecting S-Series Power Optimizers, be sure to connect the short Minus (-) output connector of one Power Optimizer to the long Plus (+) output connector of the next Power Optimizer.
2. To minimize electromagnetic interference (EMI), make sure to minimize the distance between the positive and negative DC cables.

For detailed instructions, see:

<https://www.solaredge.com/sites/default/files/se-emi-performance-application-note.pdf>.



3. Connect the rest of the power optimizers in the string in the same manner.

WARNING!

If using a dual-input power optimizer and some inputs are not used, seal the unused input connectors with the supplied pair of seals.

4. If you intend to monitor the installation, using the monitoring platform, record the physical location of each power optimizer, as described in *Creating Logical and Physical Layout using Installation Information* on page 37

Step 4: Verifying Proper Power Optimizer Connection

When a module is connected to a Power Optimizer, the Power Optimizer outputs a safe voltage of 1V ($\pm 0.1V$). Therefore, the total PV string voltage should equal 1V times the number of Power Optimizers connected in series in the PV string. For example, if 10 Power Optimizers are connected in a PV string, then 10V should be produced.

Make sure the PV modules are exposed to sunlight during this process. The Power Optimizer will only turn ON if the PV module provides at least 2W.

In SolarEdge systems, due to the introduction of Power Optimizers between the PV modules and the inverter, the short circuit current I_{SC} and the open circuit voltage V_{OC} hold different meanings from those in traditional systems.

For more information about the SolarEdge system's PV string Voltage and current, refer to the V_{OC} and I_{SC} in *SolarEdge Systems Technical Note*, available on the SolarEdge website at:

https://www.solaredge.com/sites/default/files/isc_and_voc_in_solaredge_systems_technical_note.pdf



→ To verify proper Power Optimizer connection:

- Measure the voltage of each PV string individually before connecting it to the other PV strings or to the inverter. Verify correct polarity by measuring the PV string polarity with a voltmeter. Use a voltmeter with at least 0.1V measurement accuracy.

**NOTE**

Since the inverter is not yet operating, you may measure the PV string Voltage and verify correct polarity on the DC wires inside the .

For troubleshooting Power Optimizer operation problems, refer to *Power Optimizer Troubleshooting* on page 53.

Proper Power Optimizer connection can also be verified in the Designer application.

For more information, refer to

<https://www.solaredge.com/products/installer-tools/designer#/>.



Chapter 3: Installing the Inverter

Install the inverter either before or after the PV modules and power optimizers have been installed.



CAUTION!

Do not rest the connectors at the bottom of the inverter on the ground, as it may damage them. To rest the inverter on the ground, lay it on its back.

Inverter Package Contents

- One inverter
- Mounting bracket kit
- Warranty card
- Technical Specifications page

Identifying the Inverter

Refer to the sticker on the inverter that specifies its **Serial Number** and its **Electrical Ratings**. Provide the serial number when contacting SolarEdge support. The serial number is also required when opening a new site in the monitoring platform.

Inverter Interfaces

The following figure shows the inverter connectors and components, located at the bottom of the inverter.

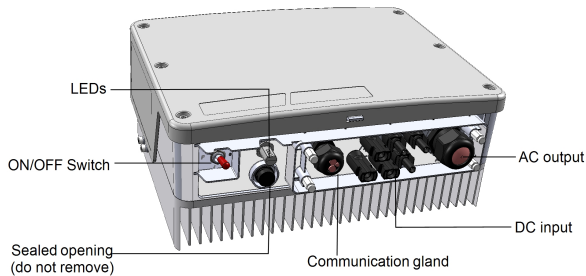

Figure 3: Inverter Interfaces

- **AC output:** AC output gland, AC cable external gauge, M32 (15-21mm diameter) for connection to the grid
- **DC input:** MC4 connector, for connection of the PV installation.
- **Communication gland:** For connection of inverter communication options. Refer to *Setting Up Communication with the Monitoring Platform* on page 39 for more information.
- **Drain valve:** Drains any moisture that may be accumulated in the unit.
- **ON/OFF/P switch:**
 - **ON (1)** - Turning this switch ON (after Power Optimizer pairing) starts the operation of the power optimizers, enables power production and allows the inverter to begin exporting power to the utility grid.
 - **OFF (0)** - Turning this switch OFF reduces the power optimizer voltage to a low safety voltage and inhibits exportation of power. When this switch is OFF, the control circuitry remains powered up.

- P - Moving and releasing the switch allows viewing system information via the LEDs, and performing the following functions:

P Position Duration	Function	Comments
Switch moved to P for 2 seconds , then released.	<ul style="list-style-type: none"> ■ Displays (via LEDs) production information for 5 seconds, or error type indications (if exist) for 5 seconds. ■ Activates the Wi-Fi access point for connecting to the SetApp 	<p>While the switch is in P, all LEDs are ON.</p> <p>When the switch is released all LEDs turn OFF for 0.5 sec and then display the production or error indication.</p>
Switch moved to P for more than 5 seconds , then released.	Starts pairing	Pairing is indicated by all 3 LEDs blinking simultaneously.

- **LEDs:** three LEDs indicate, by color and state (on/ off/ blinking⁽¹⁾/ flickering⁽²⁾/alternating⁽³⁾), different system information, such as errors or performance indications. For more information, refer to <https://www.solaredge.com/leds>.

The main LED indications are:

- Blue ON - the inverter is communicating with the monitoring platform
- Green ON - the system is producing
- Green blinking - AC is connected but the system is not producing
- Red ON - system error



⁽¹⁾Blinking = Turns ON and OFF for the same duration

⁽²⁾Flickering = Turns ON for 100 mS and turns OFF for 5 seconds

⁽³⁾Alternating = alternate LED flashes

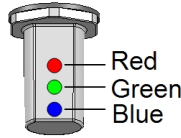

Figure 4: LEDs

The following table describes system performance information by LED color and ON/OFF/P switch position.

Indication	ON/ OFF/ P Switch Position	LED Color			Comment
		Red	Green	Blue	
Power optimizers not paired	ON (1)	OFF	Blinking	S_OK: ON No S_OK: OFF	S_OK: ON communication with the monitoring platform is established.
Pairing		Blinking	Blinking	Blinking	
Wake-up/ Grid Monitoring		OFF	Blinking	Blinking	
System Producing		OFF	ON	S_OK: ON No S_OK: OFF	
Night mode (no production)		OFF	Flickering	S_OK: ON No S_OK: OFF	
Inverter is OFF (Safe DC)	OFF (0)	OFF	Blinking	S_OK: ON No S_OK: OFF	
Inverter is OFF (DC not safe)		Blinking	Blinking	S_OK: ON No S_OK: OFF	
Inverter configuration or reboot	ON / P	ON	ON	ON	

Indication	ON/ OFF/ P Switch Position	LED Color			Comment
		Red	Green	Blue	
Inverter firmware upgrade	ON / P	Alternating	Alternating	Alternating	The upgrade process can take up to 5 minutes
Error	Any	ON	ON/ OFF/ Blinking/ Flickering	ON/ OFF / Blinking	Refer to <i>Errors and Troubleshooting</i> on page 50

The following table describes production percentage of AC information by LED color and ON/OFF/P switch position.

Indication	ON/ OFF/ P Switch Position	LED Color			Comment
		Red	Green	Blue	
Percentage of AC Production: 0 %	ON (1)	OFF	OFF	OFF	This indicates power production as percentage of rated peak AC output power
Percentage of AC Production: 0 - 33 %		OFF	ON	OFF	
Percentage of AC Production: 33 - 66 %		OFF	OFF	ON	
Percentage of AC Production: 66 - 100 %		OFF	ON	ON	

Mounting the Inverter

The inverter is supplied with a mounting bracket kit:

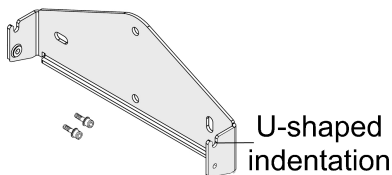

Figure 5: Mounting bracket

NOTE

Make sure the mounting surface or structure can support the weight of the inverter.

CAUTION!

SolarEdge inverters and Power Optimizers can be installed at a minimum distance of 50 m from the shoreline of an ocean or other saline environment, as long as there are no direct salt water splashes on the inverter or Power Optimizer.

For SolarEdge inverters installed at a distance of 200 m or closer to the shoreline, special brackets purchased separately from SolarEdge and SS304 stainless screws are required.

1. Determine the inverter mounting location, on a wall, stud framing or pole. It is recommended to mount the inverter in a location protected from direct sunlight.
2. To allow proper heat dissipation, maintain the following minimum clearance areas between the inverter and other objects:

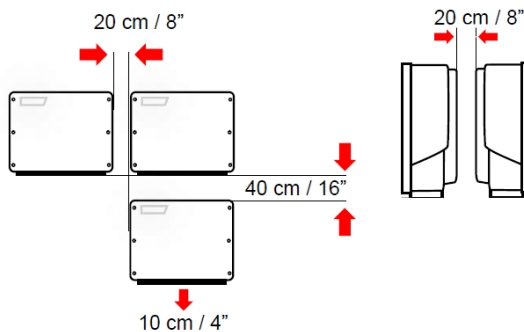

Figure 6: Clearance areas

- If installing a single inverter:
 - 20 cm from the top of the inverter.
 - At least 10 cm from the bottom of the inverter.
 - 10 cm from the right and left of the inverter.
- If installing multiple inverters:
 - When installing inverters side by side, leave at least 20 cm between inverters.
 - When installing inverters one above of the other, leave at least 40 cm between inverters.

3. Position the mounting bracket against the wall/ pole and mark the drilling hole locations (refer to the *Mechanical Specifications* appendix below for inverter and mounting bracket dimensions).
4. Drill the holes and mount the bracket. Verify that the bracket is firmly attached to the mounting surface.
5. Hang the inverter on the bracket:
 - a. Lift the inverter from the sides, or hold it at the top and bottom of the inverter to lift the unit into place.
 - b. Lower the inverter onto the U-shaped indentations, as shown below. Let the inverter lay flat against the wall or pole.
 - c. Insert the two supplied screws through the outer heat sink fin on both sides of the inverter and into the bracket.Tighten the screws with a torque of 4.0 N*m / 2.9 lb.*ft.

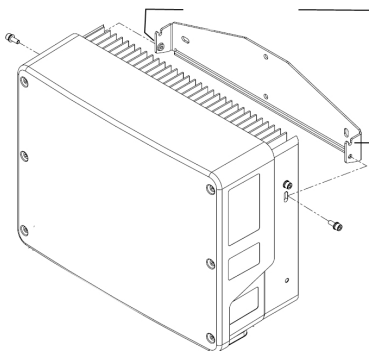

Figure 7: Hanging the inverter on the brackets

6. Optionally, secure the DC Safety Unit bracket to the wall/pole, using 3 screws:



NOTE

In case of inverter replacement with the DC Safety Unit still mounted, it is recommended to use all 3 holes.

- a. Mark the location of the bracket screw for the DC Safety Unit, and optionally the two additional bracket holes.

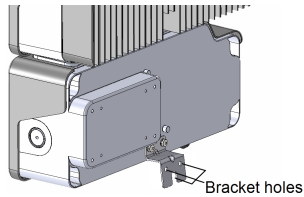

Figure 8: DC Safety Unit bracket

- b. Remove the inverter from the wall/ pole.
 - c. Drill the hole for the DC Safety Unit bracket.
 - d. Hang the inverter on the mounted brackets.
 - e. Fasten the DC Safety Unit bracket using a standard bolt.
7. Insert the screws at the top of the inverter brackets and fasten the brackets together.
 8. Verify that all the brackets are firmly attached to the mounting surface.

Chapter 4: Connecting Grid and PV Strings to the Inverter

This chapter describes how to connect the inverter to the AC grid and to the Power Optimizer of the PV modules on the strings.

Connecting the AC Grid to the Inverter

The AC output gland can fit an AC cable external gauge of PG21 (9-16 mm diameter). The maximum wire size for the input terminal blocks is 16 mm².

For more wiring information, refer to the *SolarEdge Recommended AC Wiring Application Note*, available on the SolarEdge website at <http://www.solaredge.com/files/pdfs/application-note-recommended-wiring.pdf>.



1. Turn OFF the AC circuit breaker.
2. Release the Allen screws of the inverter cover and carefully move the cover horizontally before lowering it.

CAUTION!



When removing the cover, make sure not to damage internal components. SolarEdge will not be held responsible for any components damaged as a result of incautious cover removal.

3. Strip 58 mm of the external cable insulation and strip 10 mm of the internal wire insulation.

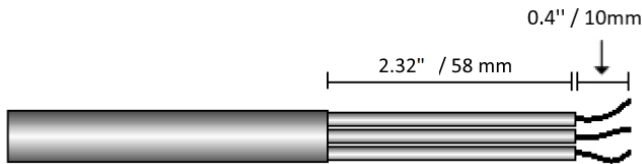

Figure 9: Insulation stripping – AC (3-wire cable)

4. Open the AC cable gland and insert the cable through the gland (see).

WARNING!



Turn OFF the AC before connecting wires to the AC terminals. If connecting equipment grounding wire, connect it before connecting the AC Line and Neutral wires.

5. Connect the AC wires according to the labels on the terminal block.

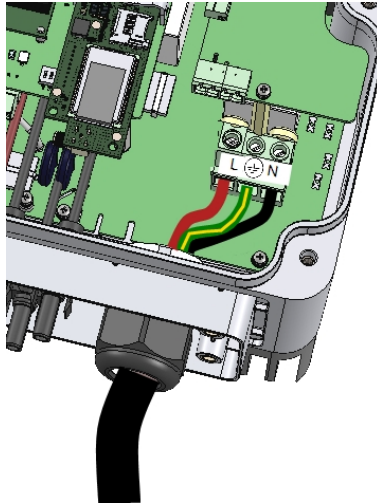

Figure 10: AC connection

6. Tighten the screws of each AC terminal with a torque of 1.2-1.5 N*m.
7. Check that the wires are fully inserted and cannot be pulled out easily.
8. Tighten the AC cable gland with a torque of 2.8-3.3 N*m.
9. Verify that there are no unconnected wires to the inverter and that the unused terminal screws are tightened.

Connecting the Strings to the Inverter

Connect the strings of power optimizers to the inverter's DC input connectors.

If required, connect the strings to an external combiner box. Then, connect the DC cables from the combiner box to the inverter's DC input connectors.

NOTE



Functional electrical earthing of DC-side negative or positive poles is prohibited because the inverter has no transformer. Grounding (earth ground) of module frames and mounting equipment of the PV modules is acceptable.

NOTE



SolarEdge fixed input voltage architecture enables the parallel to be of different lengths. Therefore, they do not need to have the same number of power optimizers, as long as the length of each string is within the permitted range.

Connect the DC connectors of each string to the DC+ and DC- connectors. See *Figure 3*.

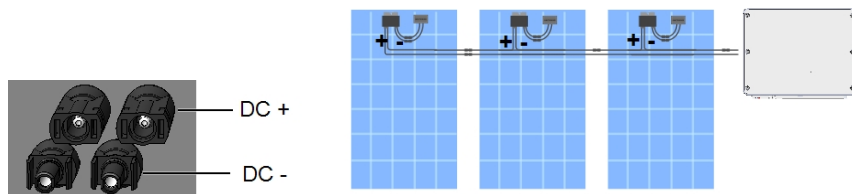

Figure 11: Inverter DC Connections

Selecting a Residual Current Device (RCD)

IMPORTANT SAFETY FEATURE



All SolarEdge inverters incorporate a certified internal Residual Current Device (RCD) in order to protect against possible electrocution and fire hazard in case of a malfunction in the PV array, cables or inverter. There are two trip thresholds for the RCD as required for certification (DIN VDE 0126-1-1). The default value for electrocution protection is 30 mA, and for slow rising current is 300 mA.

If an external RCD is required by local regulations, check which type of RCD is required for the relevant electric code. Install the residual-current device (RCD) in accordance with the applicable local standards and directives. SolarEdge recommends using a type-A RCD. The recommended RCD value is 100 mA or 300 mA unless a lower value is required by the specific local electric codes. When required by local regulations, the use of an RCD type B is permitted.



NOTE

For multiple inverters, an RCD per inverter is required.

In installations where the local electric code requires an RCD with a lower leakage setting, the discharge current might result in nuisance tripping of the external RCD. The following steps are recommended to avoid nuisance tripping of the external RCD:

- Select the appropriate RCD for correct operation of the installation: An RCD with a rating of 30 mA may actually trip at a leakage as low as 15 mA (according to IEC 61008). High quality RCDs will typically trip at a value closer to their rating.
- Configure the trip voltage of the inverter's internal RCD to a lower value than the trip current of the external RCD. The internal RCD will trip if the current is higher than the allowed current, but because the internal inverter RCD automatically resets when the residual currents are low it saves the manual reset.

For detailed information, refer to the *RCD Selection for SolarEdge Inverters Application Note*, available on the SolarEdge website at http://www.solaredge.com/sites/default/files/application_note_ground_fault_rcd.pdf.



Chapter 5: Activating, Commissioning and Configuring the System

After the solar system is installed, it is important to activate and commission the solar system. Activation and commission of the system is performed using the inverter SetApp mobile application.

During the activation and commissioning, the inverter discovers and communicates with all connected components in the solar system, such as: optimizers, peripheral communication devices and other linked inverters. When commissioning is performed, the user is required to set the grid parameters and backup Voltage information (if used).

Before starting the activation and commissioning, verify the all the communication hardware is properly connect. For communication options, refer to: *Setting Up Communication with the Monitoring Platform* on page 39.

Before arriving at the site, download SolarEdge SetApp application to your mobile device from Apple App Store or Google Play .

Before activation and commissioning, download the SetApp application from:



For downloading SetApp, Internet connection, one-time registration and logging are required. No registration is required for using the SetApp.

Step 1: Activating the Installation

During system activation, a Wi-Fi connection is created between the mobile device and the inverter and the system firmware is upgraded.

Before activation

- Download, register (first time only) and login to SetApp on your mobile device. Verify that the application is updated with the latest version.

- If applicable, turn on all devices (battery, Energy Meter) connected to the inverter, so that the devices may be auto-detected.

→ To activate the inverter:

1. Turn-on the AC circuit breaker on the main distribution panel.
2. Open SetApp and follow the on-screen instructions (scan the inverter barcode; move the ON/OFF/P switch to P position for 2 seconds and release).
SetApp creates a Wi-Fi connection, upgrades the inverter firmware and activates the inverter.
3. When the activation is complete, do one of the following:
 - Select **Connect to Another Device** to continue activating additional inverters.
 - Select **Start Commissioning** for pairing and other system configuration.

Step 2: Commissioning and Configuring the Installation

This section describes how to use the SetApp menus for commissioning and configuring the inverter settings.

Menus may vary in your application depending on your system type.

→ To access the Commissioning screen:

Do one of the following:

- During first time installation: Upon activation completion, in the SetApp, tap **Start Commissioning**.
- If the inverter has already been activated and commissioned:
 - If not already ON - turn ON AC to the inverter by turning ON the circuit breaker on the main distribution panel.
 - Open SetApp and follow the on-screen instructions (scan the inverter QR code, move the ON/OFF/P switch to P position for 2 seconds and release).
The mobile device creates a Wi-Fi connection with the inverter and displays the main Commissioning screen.

Setting Country, Grid and Language

The inverter must be configured to the proper settings in order to ensure that it complies with the country grid code and functions. Unless these settings are selected, the inverter will not start production.

1. From the **Commissioning** screen, select **Country & Grid**.
2. From the **Country & Grid** drop-down list, select the required option and tap **Set Country & Grid**.
3. If relevant, from the **Language** drop-down list, select your language and tap **Set Language**.
4. To save the information to a read-only file, tap the **PDF** icon (iOS) or the **JPEG** icon (Android) at the bottom of the screen.

Pairing

1. From the **Commissioning** menu, select **Pairing**.
2. Tap **Start Pairing**.
3. When **Pairing Complete** is displayed, the system startup process begins:
Since the inverter is ON, the Power Optimizers start producing power and the inverter starts converting AC.

WARNING!



When you turn ON the inverter ON/OFF/P switch, the DC cables carry a high Voltage and the Power Optimizers no longer output a safe output.

When the inverter starts converting power after the initial connection to the AC, the inverter enters Wake up mode until its working voltage is reached. This mode is indicated by the flickering green inverter LED.

When working voltage is reached, the inverter enters Production mode and produces power. The steadily lit green inverter LED indicates this mode.

4. Tap **OK** to return to the **Commissioning** menu.

Communication

Communication settings can be configured only after communication connections are complete. Refer to *Setting Up Communication with the Monitoring Platform* on page 39.

- Select **Monitoring Communication** to configure communication with the monitoring platform.
- Select **Site Communication** to configure communication between multiple SolarEdge devices or external non-SolarEdge devices, such as batteries or loggers.

Power Control

Power control options are detailed in the *Power Control Application Note*, available on the SolarEdge website at: https://www.solaredge.com/sites/default/files/application_note_power_control_configuration.pdf.

The Grid Control option may be disabled. Enabling it opens additional options in the menu.

The Energy Manager option is used for setting power export limitation, as described in the *Export Limitation Application Note*, available on the SolarEdge website at: https://www.solaredge.com/sites/default/files/feed-in_limitation_application_note.pdf.

Step 3: Verifying Proper Activation and Commissioning

1. Select **Information** and verify that the correct firmware versions are installed on each inverter.
2. Select **Status** and verify that inverter is operating and producing power.
3. Verify that additional configurations were properly set by viewing the relevant Status screens.
4. Verify that the green inverter LED is steadily lit.

Your SolarEdge power harvesting system is now operational.

Reporting and Monitoring Installation Data

Monitoring the site requires connecting the inverter to the monitoring platform, using any of the wired or wireless options available from SolarEdge. Refer to *Setting Up Communication with the Monitoring Platform* on page 39.

The Monitoring Platform

The monitoring platform provides enhanced PV performance monitoring and inverter yield assurance through immediate fault detection and alerts at the module, PV array and system level.

Using the platform, you can:

- View the latest performance of specific components.
- Find under-performing components, such as modules, by comparing their performance to that of other components of the same type.
- Pinpoint the location of alerted components using the physical layout.

The monitoring platform enables accessing site information, including up-to-date information viewed in a physical or logical view:

- **Logical Layout:** Shows a schematic tree-layout of the components in the system, such as: inverters, Power Optimizers, PV arrays, modules, meters and sensors, as well as their electrical connectivity. This view enables you to see which modules are connected in each PV array, which PV arrays are connected to each inverter, and so on.
- **Physical Layout:** Provides a bird's eye view of the actual placement of modules in the site, and allows pinpoint issues to the exact location of each module on a virtual site map.

If you do not report the mapping of the installed Power Optimizers, the monitoring platform will show the logical layout, indicating which Power Optimizers are connected to which inverter, but will not show PV strings or the physical location of Power Optimizers.

The monitoring platform includes a built-in help system that guides you through the monitoring functionality.

For more information, refer to <https://www.solaredge.com/products/pv-monitoring#/>.



Creating Logical and Physical Layout using Installation Information

To display a logical layout, insert the inverter serial number in the new site created in the monitoring platform. When the communication between the inverter and the monitoring server is established, the logical layout is displayed.

To display a physical layout, you need to map the locations of the installed power optimizers. To map the locations, use one of the methods described in the next sections.

Designer

Designer recommends inverter and Power Optimizer selection per site size and enables report generation. You can create a project in Designer and export the site design with the PV array layout to the monitoring platform.

For more information, refer to

<https://www.solaredge.com/products/installer-tools/designer#/>.



Mapper Application

Use the Mapper smart phone application to scan the Power Optimizer and inverter 2D barcodes and create a virtual map of a PV site for enhanced monitoring and easier maintenance.

The Mapper application is integrated with the Monitoring platform and enables:

- Simple on-site registration of new systems.
- Creating, editing and verifying system physical layout.
- Scanning and assigning the Power Optimizer serial number to the correct module in the system physical layout.

For detailed information, refer to the *Mapper* demo movies:

- [Creating new sites using the Mapper mobile application](#)
- [Mapping existing sites using the Mapper mobile application](#)



Physical Layout Editor

1. If you are a registered installer, access the monitoring platform site creation page at <https://monitoring.solaredge.com/solaredge-web/p/home#createSites>. If you have not yet signed up, go to <https://monitoring.solaredge.com/solaredge-web/p/createSelfNewInstaller>.
2. Fill out all required information in the screen, which includes information about your installation, as well as details about its logical and physical mapping.



Chapter 6: Setting Up Communication with the Monitoring Platform

The inverter sends the following information to the monitoring platform:

- Power Optimizer information received via the DC power lines (the PV output circuit)
- Inverter information
- Information of any other connected devices

This chapter describes how to set up communication between:

- The inverter and the monitoring platform through the Internet (wired/ wireless)
- Multiple inverters for a leader-follower configuration

Communication setup is not required for power harvesting, however it is needed for using the monitoring platform.

CAUTION!



When connecting the communication cables, make sure that the ON/OFF/P switch at the bottom of the inverter is turned OFF, and the AC is turned OFF.

When configuring the communication parameters, make sure that the ON/OFF/P switch (and the switch of the DC Safety Unit if applicable) is OFF, and the AC is turned ON.

Communication Options

The following types of communication can be used to transfer the monitored information from the inverter to the monitoring platform.

Only communication products offered by SolarEdge are supported.

Ethernet

Ethernet is used for a LAN connection.

RS485

RS485 is used for the connection of multiple SolarEdge devices on the same bus in a leader-follower configuration. RS485 can also be used as an interface to external devices, such as meters and third party data loggers.

For connection instructions refer to *Creating RS485 Bus Connection* on page 46.

Wi-Fi

This communication option enables using a Wi-Fi connection for connecting to the monitoring platform.

The Wi-Fi access point is built into the inverter. An antenna is required and available from SolarEdge for connection to the monitoring platform.

Wireless Gateway, Wireless Repeater(s)

The Wireless Gateway collects inverter data using a dedicated Wi-Fi connection and connects to the monitoring platform with the help of a home router. Wireless Repeater(s) extend the Wi-Fi signal range between the Wireless Gateway and inverter. Wireless Gateway and Wireless Repeaters can be purchased separately from SolarEdge. For more information, refer to <https://www.solaredge.com/sites/default/files/se-wireless-gateway-wireless-repeater-installation-guide.pdf>.



Cellular

This wireless communication option enables using a cellular connection to connect one or several devices (depending on the data plan used) to the monitoring platform.

The Cellular Plug-in is provided with a user manual, which should be reviewed prior to connection. Refer to <https://www.solaredge.com/sites/default/files/se-cellular-plug-in-for-inverters-with-setapp-installation-guide.pdf>



ZigBee

This option enables wireless connection to one or several Smart Energy products, which automatically divert PV energy to home appliances.

The Smart Energy ZigBee connections require a ZigBee plug-in and an external antenna, available from SolarEdge.

The ZigBee Plug-in for Smart Energy is provided with an installation guide, which should be reviewed prior to connection. Refer to <https://www.solaredge.com/sites/default/files/se-zigbee-plug-in-for-setapp-installation-guide.pdf>

The Smart Energy products are provided with an installation guide, which should be reviewed prior to connection. Refer to https://www.solaredge.com/products/device-control#.



Communication Connectors

A communication gland with multiple openings is used for connection of the various communication options. The table below describes the functionality of each gland opening. Unused openings should remain sealed.

Opening for cable size (diameter)	Connection type
2.5 - 5 mm	RS485
4.5 - 7 mm, with cut	Ethernet (CAT6)
2 - 4 mm, with cut	Antenna cable for wireless communication

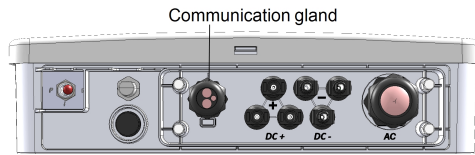

Figure 12: Communication Gland

The communication board has the following connectors:

- Standard RJ45 terminal block for Ethernet connection
- USB
- RS485 connector
- 8-pin connector for power control devices

The SolarEdge Wi-Fi antenna, ZigBee or Cellular Plug-ins can be connected to the communication board for optional wireless connection.

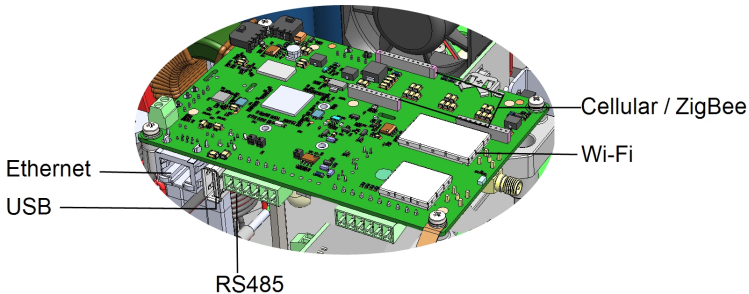

Figure 13: Communication board connectors

Removing the Inverter Cover

→ To remove the inverter cover

1. Switch off the AC circuit breaker on the main distribution panel.
2. Switch off the inverter ON/OFF/P switch and wait 5 minutes for the internal capacitors to discharge.
3. Open the Allen screws of the inverter cover and carefully pull the cover horizontally before lowering it.

CAUTION!



When removing the inverter cover, make sure not to damage the internal components. SolarEdge will not be held responsible for any components damaged as a result of incautious cover removal.

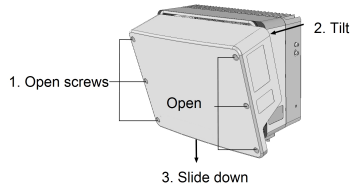

Figure 14: Removing the inverter cover

Removing the DC Safety Unit Cover (if applicable)

1. Switch off the AC circuit breaker on the main distribution panel and the safety switch (if applicable).
2. Open the DC Safety Unit cover: Release the four Allen screws and remove the cover.

CAUTION!



When removing the DC Safety Unit cover, make sure not to damage the internal components. SolarEdge will not be held responsible for any components damaged as a result of incautious cover removal.

Creating an Ethernet (LAN) Connection

This communication option enables using an Ethernet connection to connect the inverter to the monitoring platform through a LAN.

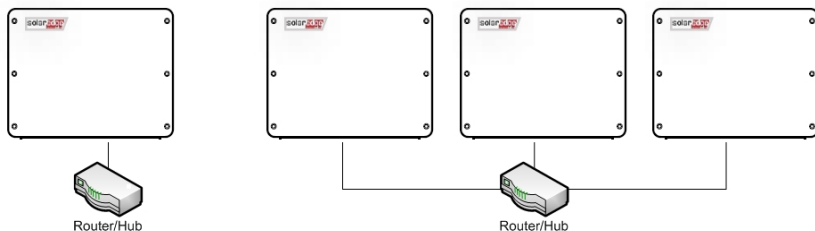

Figure 15: Example of Ethernet connection

Ethernet cable specifications:

- Cable type – a shielded CAT6 Ethernet cable
- Maximum distance between the inverter and the router – 100 m/ 330 ft.

NOTE



If using a cable longer than 10 m / 33 ft in areas where there is a risk of induced voltage surges by lightning, it is recommended to use external surge protection devices.

For details refer to:

http://www.solaredge.com/files/pdfs/lightning_surge_protection.pdf.



→ To connect the Ethernet cable:

1. Remove the inverter cover as described above.
2. Open Communication Gland 1.



CAUTION!

The gland includes a rubber waterproof fitting, which should be used to ensure proper sealing.

3. Remove the plastic seal from one of the large openings.
4. Remove the rubber fitting from the gland and insert the CAT6 cable through the gland and through the gland opening in the inverter.
5. Push the cable into the cut opening of the rubber fitting.

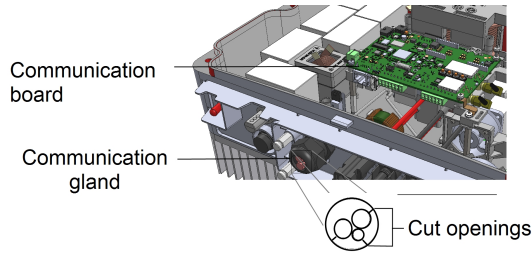

Figure 16: Communication gland and rubber fitting

CAT6 standard cables have eight wires (four twisted pairs), as shown in the diagram below. Wire colors may differ from one cable to another. You can use either wiring standard, as long as both sides of the cable have the same pin-out and color-coding.

RJ45 Pin #	Wire Color ⁽¹⁾		10Base-T Signal 100Base-TX Signal
	T568B	T568A	
1	White/Orange	White/Green	Transmit+
2	Orange	Green	Transmit-
3	White/Green	White/Orange	Receive+
4	Blue	Blue	Reserved
5	White/Blue	White/Blue	Reserved
6	Green	Orange	Received-
7	White/Brown	White/Brown	Reserved
8	Brown	Brown	Reserved

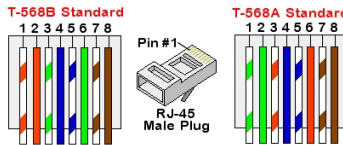

Figure 17: Standard cable wiring

⁽¹⁾The inverter connection does not support RX/TX polarity change. Supporting crossover Ethernet cables depends on the switch capabilities.

6. Use a pre-crimped cable to connect via Communication Gland 1 to the RJ45 plug on the inverter's communication board or, if using a spool of cable, connect as follows:
 - a. Insert the cable through the gland.
 - b. Remove the cable's external insulation using a crimping tool or cable cutter and expose eight wires.
 - c. Insert the eight wires into an RJ45 connector (see *Figure 17*).
 - d. Use a crimping tool to crimp the connector.
 - e. Connect the Ethernet connector to the RJ45 port on the communication board (see *Figure 13*).

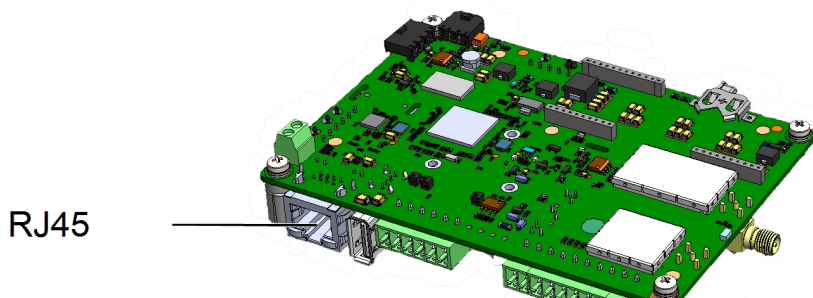

Figure 18: The RJ45 Ethernet connection

7. For the switch/router side, use a pre-crimped cable or use a crimper to prepare an RJ45 communication connector: Insert the eight wires into the RJ45 connector in the same order as above (see *Figure 17*).
8. Connect the cable RJ45 connector to the RJ45 port of the Ethernet switch or router. You can connect more than one inverter to the same switch/router or to different switches/routers, as needed. Each inverter sends its monitored data independently to the SolarEdge monitoring platform.
9. The inverter is configured by default to LAN. If reconfiguration is required:
 - a. Make sure the ON/OFF/P switch is OFF.
 - b. Turn ON the AC to the inverter by turning ON the circuit breaker on the main distribution panel.
 - c. Configure the connection as described in *Communication* on page 35.

NOTE

If your network has a firewall, you may need to configure it to enable the connection to the following address:

- Destination Address: **prodssl.solaredge.com**
- TCP Port: **443** (for incoming and outgoing data)

10. Verify the connection, as described in *Verifying the Connection* on page 49.

Creating RS485 Bus Connection

The RS485 option enables creating a bus of connected inverters, consisting of up to 31 follower inverters and 1 leader inverter. Using this option, inverters are connected to each other in a bus (chain), via their RS485 connectors. The first and last inverters in the chain must be terminated as described on page 48.

RS485 wiring specifications:

- Cable type: CAT6 and higher with shielding protection of the twisted pairs of wires and an outer foil or braided shielding
- Wire cross-section area: 0.2- 1mm²
- Maximum nodes: 32
- Maximum distance between first and last devices: 1000m.

NOTE

If using a cable longer than 10 m/33 ft in areas where there is a risk of induced voltage surges by lightning, it is recommended to use external surge protection devices. For details refer to:

https://www.solaredge.com/sites/default/files/lightning_surge_protection.pdf.



If grounded metal conduits are used for routing the communication wires, a lightning protection device is not required.

If not using surge protection, connect the grounding wire to the first inverter in the RS485 chain; make sure the grounding wire is not in contact with other wires. For inverters with a DC Safety Unit, connect the grounding wire to the grounding bus-bar in the DC Safety Unit.

The following sections describe how to physically connect the RS485 bus and how to configure the bus.

→ To connect the RS485 communication bus:

1. Remove the inverter cover, as described above.
2. Open Communication Gland and insert the cable through one of the openings.
3. Remove the connector, as shown below.

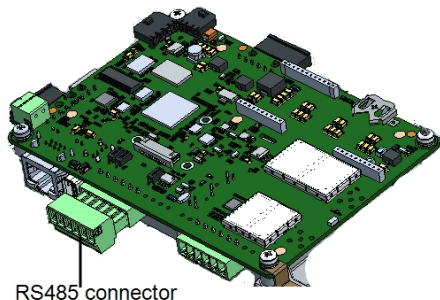

Figure 19: RS485 connector on the communication board

4. Loosen the screws of pins A(+), B(-), and G on the left of the RS485 connector (RS485-1).

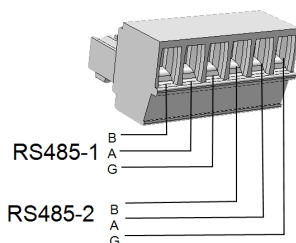
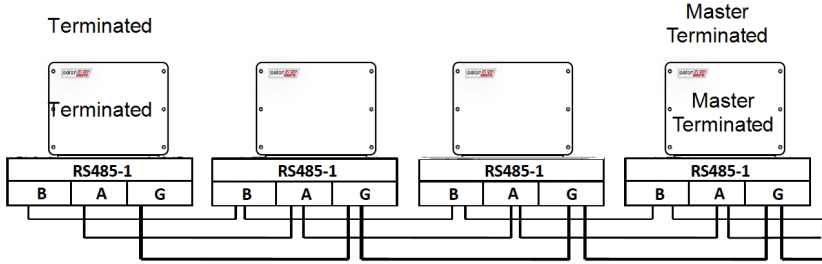

Figure 20: RS485 connector

5. Insert the wire ends into the **B**, **A** and **G** opening on the connector. You can use any color wire for each of the **B**, **A** and **G** connections, as long as:
 - The same color wire is used for all A pins the same color for all B pins and the same color for all G pins
 - The wire for G is not from the same twisted pair as A or B.
6. For creating an RS485 bus, connect all B, A and G pins in all inverters.



NOTE

Do not cross-connect B, A and G wires.

7. Tighten the connector screws.
8. Check that the wires are fully inserted and cannot be pulled out easily.
9. Connect the RS485 connector to the RS485 port on the communication board.
10. Terminate the first and last SolarEdge inverter in the chain. The inverter can be terminated by switching on (up) the left DIP switch on the communication board.

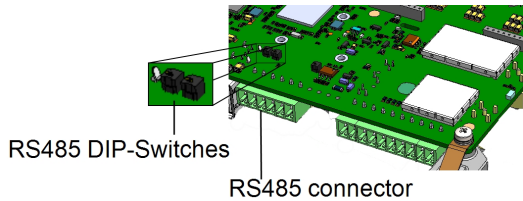

Figure 21: RS485 termination switch

NOTE



Only the first and last SolarEdge inverter in the chain must be terminated. In the other inverters in the chain, the DIP switch must be in the off (down) position.

11. If no surge protection is used, connect the grounding wire to the first inverter in the RS485 chain; make sure the grounding wire is not in contact with other wires. For inverters with a DC Safety Unit, connect the grounding wire to the grounding bus-bar in the DC Safety Unit.

RS485 Bus Configuration

→ To connect to the monitoring platform:

1. Designate a single inverter as the connection point between the RS485 bus and the monitoring platform. This inverter will serve as the leader inverter.
2. Connect the leader to the monitoring platform using Ethernet (refer to *Creating an Ethernet (LAN) Connection* above).

→ To configure the RS485 bus:

All inverters are configured by default as followers. To configure the leader:

1. Make sure the inverter's ON/OFF/P switch is off.
2. Make sure that the AC circuit breaker on the main distribution panel is on.
3. Access SetApp, as described in *Communication* on page 35.
4. From the **Commissioning** screen, select **Site Communication** > **RS485-** > **Protocol** > **SolarEdge** > **SolarEdge Leader**.
5. Return to the **RS485-** screen and select **Follower Detect**.

The system starts automatic detection of the follower inverters connected to the leader inverter. The inverter should report the correct number of followers. If it does not, verify the connections and terminations in all inverters in the chain.

6. To check the follower IDs and last communication time, select **RS485-** > **Follower List**.
7. Verify the connection of the leader to the monitoring platform, as described below.

Verifying the Connection

After connecting and configuring a communication option, perform the following steps to check that the connection to the Monitoring platform has been successfully established.

1. Commission the inverter as describe in "**Activating, Commissioning and Configuring the System**" on page 33.
2. Access SetApp and select **Status** from the **Configuring** screen.
3. In the **Summary** section, under **Server Comm.**, make sure **S_OK** is displayed together with the selected communication option.
4. Scroll down to the **Communication** section and check that the communication options are as required.

Appendix A: Errors and Troubleshooting

This chapter describes how to troubleshoot general system problems. For further assistance, contact SolarEdge Support.

Identifying Errors

Errors may be indicated in various system interfaces: On the inverter bottom panel, a red LED indicates an error. In the monitoring platform and SetApp, errors are displayed with codes.

For more information on the codes displayed for error and warning messages, refer to <http://www.solaredge.com/sites/default/files/se-inverter-installation-guide-error-codes.pdf>. This document describes errors that appear in SetApp, monitoring platform, and LCD (for inverters with LCD). To identify the error types, use the methods described below.



→ To identify the error type using the inverter LEDs:

1. Move the ON/OFF/P switch to **P** position for **2 seconds** and release it.
2. Observe the LED lights and use the following table to identify the error type. For more information, refer to:

<https://www.solaredge.com/leds>



Error Type	Inverter LED Color and State		
	Red	Green	Blue
Arc detected	ON	OFF	OFF
Isolation or RCD problem	Blinking	OFF	OFF
Grid error	OFF	ON	OFF
High temperature	OFF	Blinking	OFF
Pairing failed	OFF	OFF	ON
Other issue	OFF	OFF	Blinking

→ To identify the error type using the monitoring platform:

1. Open the site dashboard and click the **Layout** icon.
2. Right-click the inverter and select **Info** from the menu. The inverter details window is displayed.
3. Click the **Errors** tab. The list is displayed.

Troubleshooting Communication

Troubleshooting Ethernet (LAN) Communication

The possible errors and their troubleshooting are detailed in the following table:

Error Message	Possible Cause and Troubleshooting
LAN cable disconnected	Physical connection fault. Check the cable pin-out assignment and cable connection.
No DHCP	IP settings issue. Check the router and configuration. Consult your network IT.
Configure Static IP or set to DHCP	
Gateway not responding	Ping to router failed. Check the physical connection to the switch/ router. Check that the link LED at the router /switch is lit (indicating phy-link). If OK - contact your network IT, otherwise replace the cable or change it from cross to straight connection.
No Internet connection	Ping to google.com failed. Connect a laptop and check for internet connection. If internet access is unavailable, contact your IT admin or your internet provider. For Wi-Fi networks, ensure that user-name and password are as defined in the internet provider AP/ router.

Troubleshooting RS485 Communication

- If the message **RS485 Leader Not Found** appears in the Status screen, check the connections to the leader device and fix if required.
- If after follower detection the number of followers displayed for the leader under **RS485- > Follower Detect** is lower than the actual number of followers, refer to the following application note to identify missing followers and troubleshoot connectivity problems:
https://www.solaredge.com/sites/default/files/troubleshooting_undetected_RS485_devices.pdf

Additional Troubleshooting

1. Check that the modem or hub/router is functioning properly.
2. Check that the connection to the internal connector on the communication board is properly done.
3. Check that the selected communication option is properly configured.
4. Use a method independent of the SolarEdge device to check whether the network and modem are operating properly. For example, connect a laptop to the Ethernet router and connect to the Internet.
5. Check whether a firewall or another type of network filter is blocking communication.

Power Optimizer Troubleshooting

Malfunction	Possible Cause and Corrective Action
Pairing failed	<p>Power Optimizers are shaded.</p> <p>If you connected the inverter to the monitoring platform, retry pairing remotely (during sunlight). Make sure to leave the inverter ON/OFF/P switch ON and that S_OK appears in the status screen.</p>
PV string Voltage is 0V	<p>Power Optimizer (s) output is disconnected.</p> <p>Connect all Power Optimizer outputs.</p>
PV string voltage not 0V but lower than number of Power Optimizers	<p>Power Optimizer(s) not connected in the PV string.</p> <p>Connect all Power Optimizers.</p>
	<p>Panel(s) not connected properly to Power Optimizer inputs (not applicable to smart modules).</p> <p>Connect the modules to the Power Optimizer inputs.</p>
	<p>PV string reverse polarity.</p> <p>Check PV string polarity using a voltmeter and correct if needed.</p>

Malfunction	Possible Cause and Corrective Action
<p>PV string Voltage is higher than number of Power Optimizers</p> <p>WARNING! If the measured voltage is too high, the installation may not have a safe low voltage. PROCEED WITH CARE! A deviation of $\pm 1\%$ per PV string is reasonable.</p> 	<p>Extra Power Optimizer(s) connected in the PV string (not applicable to smart modules). Check if an extra Power Optimizer is connected in the PV string. If not – proceed to next solution.</p> <p>A module is connected directly to the PV string, without a Power Optimizer (not applicable to smart modules). Verify that only Power Optimizers are connected in the PV string and that no module outputs are connected without a Power Optimizer. If the problem persists, proceed to the next step.</p> <p>Power Optimizer(s) malfunction.</p> <ol style="list-style-type: none"> 1. Disconnect the wires connecting the Power Optimizers in the PV string. 2. Measure the output voltage of each Power Optimizer to locate the Power Optimizer that does not output 1V safety Voltage. If a malfunctioning Power Optimizers located, check its connections, polarity, module, and Voltage. 3. Contact SolarEdge Support. Do not continue before finding the problem and replacing the malfunctioning Power Optimizer. If a malfunction cannot be bypassed or resolved, skip the malfunctioning Power Optimizer, thus connecting a shorter PV string.

Appendix B: Mechanical Specifications

The following figure provides inverter dimensions in mm [in].

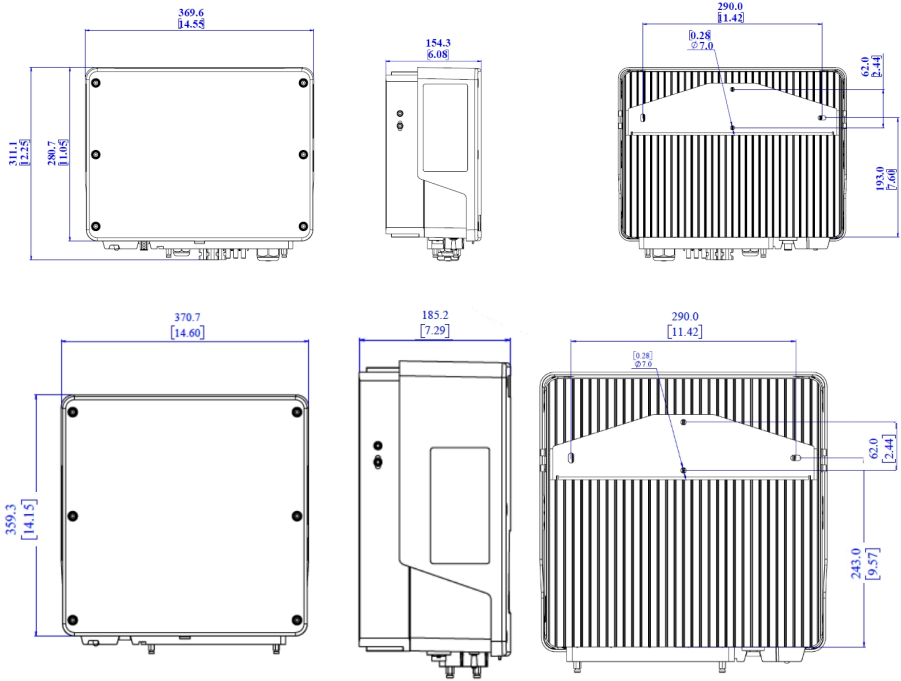

Figure 22: SE10000H-SE11400H inverter dimensions

Appendix C: Maintenance and System Components Replacement

This appendix includes replacement procedures for the SolarEdge system components. Operational settings including grid protection settings may be reviewed periodically as part of a routine maintenance procedure.

NOTE



If you are permanently disassembling the installation or part of it, make sure to use the disposal methods dictated by local regulations.

Replacing an Inverter

1. Turn OFF the inverter ON/OFF/P switch, and wait until the green LED is blinking , indicating that the DC voltage is safe (<50V), or wait five minutes before continuing to the next step.
2. Disconnect the AC to the inverter by turning OFF the AC circuit breaker of the distribution panel.
3. For inverters with a Connection Unit, turn OFF the DC Safety Unit.
4. Open the DC Safety Unit cover (if applicable): Release the four Allen screws and remove the cover.
5. Open the inverter cover as described in *Removing the Inverter Cover* on page 42.
6. Disconnect the DC plugs from the inverter.
7. Disconnect the AC wires from the AC terminal block and remove the ferrite bead.

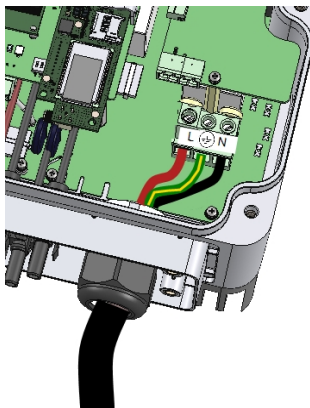

Figure 23: AC connections

8. Disconnect the DC and AC cables from the DC Safety Unit (if applicable).
9. Disconnect the wires connected to the inverter or between the inverter and the DC Safety Unit:
 - Antenna cable from the communication board
 - DC and AC wires in the DC Safety Unit
 - Grounding cable
10. Disconnect the DC Safety Unit from the inverter by opening the two clips securing the DC Safety Unit to the inverter: Carefully place a screwdriver between the clip and the enclosure and pull the clip.

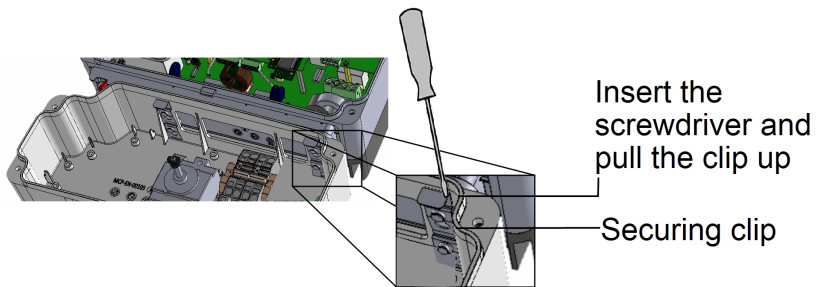

Figure 24: Disconnecting the DC Safety Unit from the inverter

11. Remove the screws securing the inverter to the mounting brackets and lift the inverter from the mounting bracket.

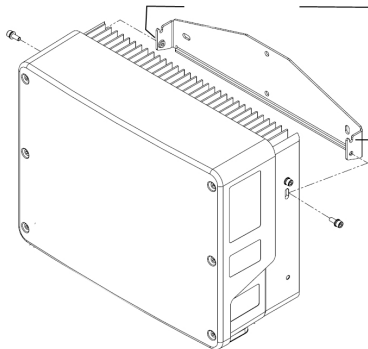

Figure 25: Mounting brackets

**NOTE**

If you remove the old inverter and do not immediately install a new one, use insulation tape to isolate each of the AC and DC wires

12. Place the new inverter on the mounting brackets and secure it using the screws.
13. Insert the wires from the DC Safety Unit into the openings in the inverter and the ferrite bead.
14. Fasten the two clips securing the DC Safety Unit to the inverter.
15. Reconnect the cables: Follow the instructions of .
16. Close the inverter and DC Safety Unit covers.
17. Perform the commissioning steps as described in *Activating, Commissioning and Configuring the System* on page 33.

Replacing the DC Safety Unit

1. Turn OFF the inverter ON/OFF/P switch, and wait until the green LED is blinking, indicating that the DC voltage is safe (<50V), or wait five minutes before continuing to the next step.
2. Turn OFF the AC breaker of the distribution panel and the DC Safety Unit.
3. Open the DC Safety Unit cover: Release the four Allen screws and remove the cover.
4. Open the inverter cover as described in *Removing the Inverter Cover* on page 42.
5. Disconnect the DC wires from the inverter and the AC wires from the DC Safety Unit.
6. Disconnect the wires between the inverter and the DC Safety Unit.
 - Antenna cable from the communication board
 - RS485 and/or Ethernet connection from the communication board
 - Grounding cable
7. Open the DC Safety Unit bracket screws.

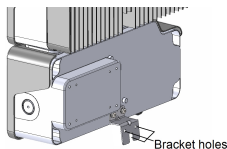

Figure 26: DC Safety Unit bracket

8. Disconnect the DC Safety Unit from the inverter by opening the two clips securing the DC Safety Unit to the inverter: Carefully place a screwdriver between the clip and the enclosure and pull the clip.

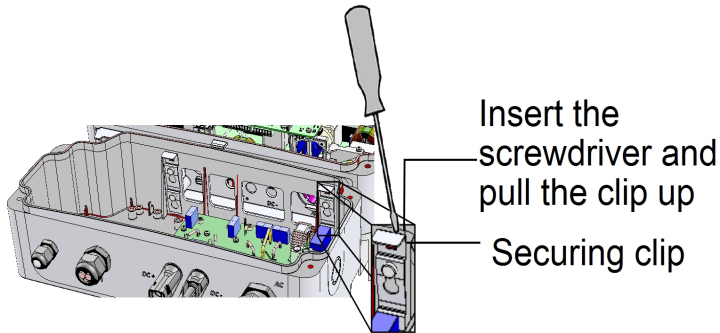

Figure 27: Disconnecting the DC Safety Unit from the inverter

9. Detach the DC Safety Unit from the inverter.
10. Place the new DC Safety Unit and secure it to the inverter using the clips.
11. Insert the wires from the inverter into the openings in the DC Safety Unit and the ferrite bead.
12. Reconnect the cables, as explained in *Installing the Inverter* on page 21.
13. Close the inverter cover.
14. Fasten the Safety Switch bracket using a standard bolt.
15. Perform the commissioning steps as described in *Activating, Commissioning and Configuring the System* on page 33.

Adding, Removing, or Replacing Power Optimizers

1. Turn OFF the inverter ON/OFF/P switch, and wait until the green LED is blinking , indicating that the DC voltage is safe (<50V), or wait five minutes before continuing to the next step.
2. Disconnect the AC to the inverter by turning OFF the circuit breakers on the distribution panel.
3. Turn OFF the DC Safety Unit (if applicable).
4. Disconnect and connect the necessary power optimizers.
5. Perform pairing and other procedures described in *Activating, Commissioning and Configuring the System* on page 33 on all inverters to which power optimizers were added or from which power optimizers were removed.

6. In the monitoring platform, use the **Replace** button in the **logical layout** tab (in site Admin). Replace the serial number of the removed power optimizer with the serial number of the newly installed power optimizer. Refer to <https://www.solaredge.com/sites/default/files/se-monitoring-portal-site-admin.pdf>



Appendix D: SafeDC™

The SolarEdge inverters are certified for compliance with the following standards as disconnection devices for PV generators, meaning that they can replace a DC disconnect:

- IEC 60947-3:1999 + Corrigendum: 1999 + A1:2001 + Corrigendum 1:2001 + A2:2005;
- DIN EN 60947-3
- VDE 0660-107:2006-03
- IEC 60364-7-712:2002-05
- DIN VDE 0100-712:2006-06.

In compliance with these standards, follow the instructions below to disconnect DC power:

1. Move the inverter P/ON/OFF switch to OFF (0) and wait 5 minutes for the capacitors to discharge.
2. Disconnect the AC to the inverter by turning OFF the circuit breakers on the distribution panel.

Technical Specifications - Single Phase Inverters with HD-Wave Technology (Europe & APAC)

	SE2200H	SE3000H	SE3500H	SE3680H	SE4000H	SE5000H	SE6000H	Units
OUTPUT								
Rated AC Power Output	2200	3000	3500	3680	4000	5000 ⁽¹⁾	6000	VA
Maximum AC Power Output	2200	3000	3500	4000	4000	5000 ⁽¹⁾	6000	VA
AC Output Voltage (Nominal)	220 / 230							Vac
AC Output Voltage Range	184 - 264.5							Vac
AC Frequency (Nominal)	50 / 60 ± 5							Hz
Maximum Continuous Output Current	10	14	16	16	18.5	23	27.5	A
Maximum Continuous Overcurrent Protection	10	14	16	16	18.5	23	27.5	A
Residual Current Detector / Residual Current Step Detector	300 / 30							mA
Inrush current AC (Peak/Duration)	2.8 / 20							Aac (rms) / ms
Maximum Output Fault Current	38							A
Power Factor Range	1 (adjustable from -0.9 to +0.9)							
Total Harmonic Distortion	< 3							%
Protective class	Class I							

⁽¹⁾SE5000H is limited to 4600VA in Germany

	SE2200H	SE3000H	SE3500H	SE3680H	SE4000H	SE5000H	SE6000H	Units
Utility Monitoring, Islanding Protection, Country Configurable Thresholds	Yes							
Overvoltage Category	III							
INPUT								
Maximum DC Power	3400	4650	5425	5700	6200	7750 ⁽¹⁾	9300	W
Transformer-less, Ungrounded	Yes							
Maximum Input Voltage	480							Vdc
Nominal DC Input Voltage	380							Vdc
Maximum Input Current	6.5	9	10	10.5	11.5	13.5	16.5	A dc
Maximum Back-feed Current	0							
Reverse-Polarity Protection	Yes							
Ground-Fault Isolation Detection	600kΩ Sensitivity							
Overvoltage Category	II							
Maximum Inverter Efficiency	99.2							%
European Weighted Efficiency	98.3	98.8				99		%
Nighttime Power Consumption	< 2.5							W
ADDITIONAL FEATURES								
Supported Communication Interfaces	RS485, Ethernet, ZigBee (optional), Wi-Fi (optional), Cellular (optional)							
Inverter Commissioning	With the SetApp mobile application using built-in Wi-Fi station for local connection							
Smart Energy Management	Export Limitation							
Arc Fault Protection	Integrated, User Configurable (According to UL1699B)							

⁽¹⁾7130VA in Germany

	SE2200H	SE3000H	SE3500H	SE3680H	SE4000H	SE5000H	SE6000H	Units	
STANDARD COMPLIANCE									
Safety	IEC-62109-1/2, NZ3100								
Grid Connection Standards	IEC61727, IEC62116, EN 50438, VDE-AR-N-4105, VDE 0126-1-1, UTE_C_15-712, G83/2, G59/3, CEI-021, ÖNORM, TF3.2.1, C10-11, NRS 097-2-1								
Emissions	IEC61000-6-2, IEC61000-6-3, IEC61000-3-11, IEC61000-3-12, FCC part15 class B								
RoHS	Yes								
INSTALLATION SPECIFICATIONS									
AC Output - Cable Gland Diameter	9 - 16								mm
AC Supported Wire Cross Section	1 - 13								mm ²
DC Input ⁽¹⁾	1 x MC4 pair				2 x MC4 pairs				
Dimensions (HxWxD)	280 x 370 x 142								mm
Noise	< 25								dBA
Weight	9.5				10.5		11		kg
Cooling	Natural Convection								
Operating Temperature Range ⁽²⁾	-40 to +60								°C
Protection Rating	IP65 - Outdoor and Indoor								

⁽¹⁾Connection of additional strings in parallel to a single input is allowed as long as the cumulative current does not exceed 45A.

⁽²⁾Full power up to at least 50°C / 122°F. For power de-rating information refer to: <https://www.solaredge.com/sites/default/files/se-temperature-derating-note.pdf>

Recommended circuit breaker/ fuse size to use at the connection point of the SolarEdge inverter to the grid:

Inverter	Maximum Output Current (A)	Minimum Fuse Rating (A)	Maximum fuse rating (A)
SE2200H	10	16	50
SE3000H	14	20	50
SE3500H	16	20	50
SE3680H	16	20	50
SE4000H	18.5	25	50
SE5000H	23	32	50
SE6000H	27.5	40	50

Technical Specifications - Single Phase Inverters with HD-Wave Technology (Europe & APAC)

	SE8000H	SE10000H	Units
OUTPUT			
Rated AC Power Output	8000	10000	VA
Maximum AC Power Output	8000	10000	VA
AC Output Voltage (Nominal)	220 / 230		Vac
AC Output Voltage Range	184 - 264.5		Vac
AC Frequency (Nominal)	50 / 60 ± 5		Hz
Maximum Continuous Output Current	36.5	45.5	A
Max. continuous overcurrent protection	36.5	45.5	A
Residual Current Detector / Residual Current Step Detector	300 / 30		mA
Inrush current AC (Peak/Duration)	3.45 / 20		Aac(rms) / ms
Max. output fault current	80		A
Power factor range	1 (adjustable from -0.8 to +0.8)		
Total harmonic distortion	< 3		%
Protective class	Class I		
Utility Monitoring, Islanding Protection, Country Configurable Thresholds	Yes		
Overvoltage category	III		

	SE8000H	SE10000H	Units
INPUT			
Maximum DC Power	12400	15500	W
Transformer-less, Ungrounded		Yes	
Maximum Input Voltage		480	Vdc
Nominal DC Input Voltage		400	Vdc
Maximum Input Current	20.5	25.5	Adc
Maximum back-feed current		0	
Reverse-Polarity Protection		Yes	
Ground-Fault Isolation Detection		600k Ω Sensitivity	
Overvoltage category		II	
Maximum Inverter Efficiency		99.2	%
European Weighted Efficiency		99	%
Nighttime Power Consumption		< 2.5	W
ADDITIONAL FEATURES			
Supported communication interfaces	RS485, Ethernet, ZigBee (optional), Built-in GSM (Optional)		
Inverter commissioning	With the SetApp mobile application using built-in Wi-Fi station for local connection		
Smart Energy Management	Export Limitation		
STANDARD COMPLIANCE			
Safety	IEC-62109-1/2,		
Grid Connection Standards	G83/1, G83/2, G59/3, RD661, RD1699, UTE C15-712		
Emissions	IEC61000-6-2, IEC61000-6-3, IEC61000-3-11, IEC61000-3-12, FCC Part 15 Class B		
RoHS	Yes		

	SE8000H	SE10000H	Units
INSTALLATION SPECIFICATIONS			
AC Output - Cable Gland diameter	9 - 16		mm
AC Supported Wire Cross Section	1 - 13		mm ²
DC Input ⁽¹⁾	3 x MC4 pair		
Dimensions (HxWxD)	360 x 370 x 185		mm
Noise	< 50		dBA
Weight	16.5		kg
Cooling	Natural Convection		
Operating Temperature Range ⁽²⁾	-40 to +60		°C
Protection Rating	IP65 - Outdoor and Indoor		

Recommended circuit breaker/ fuse size to use at the connection point of the SolarEdge inverter to the grid:

Inverter	Maximum Output Current (A)	Minimum Fuse Rating (A)	Maximum fuse rating (A)
SE8000H	36.5	50	80
SE10000H	45.5	63	80

⁽¹⁾Connection of additional strings in parallel to a single input is allowed as long as the cumulative current does not exceed 45A.

⁽²⁾For power de-rating information refer to: <https://www.solaredge.com/sites/default/files/se-temperature-derating-note.pdf>

Technical Specifications - Single Phase Inverters with HD-Wave Technology (Australia)

Applicable to inverters with part number SEXXXXH-AUXXXBXX4

	SE2500H	SE3000	SE4000H	SE5000H	SE6000H	SE8000H	SE8250H	SE10000H	Units
OUTPUT									
Rated AC Power Output	2500	3000	4000	5000	6000	8000	8250	10000	VA
Maximum AC Power Output	2500	3000	4000	5000	6000	8000	8250	10000	VA
AC Output Voltage (Nominal)	220 / 230								Vac
AC Output Voltage Range	184 - 264.5								Vac
AC Frequency (Nominal)	50 / 60 ± 5								Hz
Maximum Continuous Output Current	11.5	14	18.5	21.7	27.5	36.5	37.5	45.5	A
Max. continuous overcurrent protection	11.5	14	18.5	21.7	27.5	36.5	37.5	45.5	A
Residual Current Detector / Residual Current Step Detector	300 / 30								mA
Inrush current AC (Peak / Duration)	2.8 / 20					3.45 / 20			Aac (rms) / ms
Max. output fault current	35			48		80			A
Power factor range	1 (adjustable from -0.8 to +0.8)								
Total harmonic distortion	< 3								%
Protective class	Class I								
Utility Monitoring, Islanding Protection, Country Configurable Thresholds	Yes								
Overvoltage category	III								

	SE2500H	SE3000	SE4000H	SE5000H	SE6000H	SE8000H	SE8250H	SE10000H	Units	
INPUT										
Maximum DC Power	3875	4650	6200	7750	9300	12400	12785	15500	W	
Transformer-less, Ungrounded	Yes									
Maximum Input Voltage	480									
Nominal DC Input Voltage	380					400				Vdc
Maximum Input Current	7.5	9	11.5	13.5	16.5	20.5	22	26	Adc	
Maximum back-feed current	0									
Reverse-Polarity Protection	Yes									
Ground-Fault Isolation Detection	600kΩ Sensitivity									
Overvoltage category	II									
Maximum Inverter Efficiency	99.2									
European Weighted Efficiency	98.3	98.8						99	%	
Nighttime Power Consumption	< 2.5									
ADDITIONAL FEATURES										
Supported Communication Interfaces	RS485, Ethernet, ZigBee (optional), Wi-Fi (Built-in; antenna included), Cellular (Optional)									
Smart Energy Management	Export Limitation									
Arc Fault Protection	Integrated, User Configurable (According to UL1699B)									
Inverter Commissioning	with the SetApp mobile application using built-in Wi-Fi Access-Point for local connection									
STANDARD COMPLIANCE										
Safety	IEC-62109, AS/NZ3100									
Grid Connection Standards	AS/NZ4777:2015									
Emissions	IEC61000-6-2, IEC61000-6-3, IEC61000-3-11, IEC61000-3-12, FCC part15 class B									

	SE2500H	SE3000	SE4000H	SE5000H	SE6000H	SE8000H	SE8250H	SE10000H	Units
RoHS	Yes								
INSTALLATION SPECIFICATIONS									
AC output conduit size / Wire cross section	19-25 mm / 1-13 mm ²								
DC input conduit size / # of strings / Wire cross section	19-25 mm / 1-2 strings / 1-13 mm ²				19-25 mm / 1-3 strings / 1-13 mm ²				
AC Terminal Block Cross Section	1-13								mm ²
Dimensions with Safety Switch (HxWxD)	450 x 370 x 174				540 x 370 x 185				mm
Weight with Safety Switch	10		11.4		11.9		17.6		kg
Cooling	Natural Convection								
Operating Temperature Range ⁽¹⁾	-40 to +60								°C
Noise	< 25				< 50				dBa
Protection Rating	IP65 - Outdoor and Indoor								

Recommended circuit breaker/ fuse size to use at the connection point of the SolarEdge inverter to the grid:

Inverter	Maximum output current (A)	Minimum fuse rating (A)	Maximum fuse rating (A)
SE2500H	12.5	16	50
SE3000H	16	20	50
SE4000H	18.5	25	50
SE5000H	23	32	50
SE6000H	27	40	50
SE8000H	48	63	80

⁽¹⁾ Full power up to at least 50°C. For power de-rating information refer to: <https://www.solaredge.com/sites/default/files/se-temperature-derating-note.pdf>

Inverter	Maximum output current (A)	Minimum fuse rating (A)	Maximum fuse rating (A)
SE8250H	48	63	80
SE10000H	48	63	80

Communication Board - Technical Specifications

Power		
Input voltage	5	Vdc
Connector type	Micro-fit	
Power consumption	<3	W
Operating temperature	-40°C – 105	°C
Communication interfaces		
RS485 interfaces	2 ports	
Ethernet interface	10/100-BaseT	
Wi-Fi interface	802.11b/802.11g/802.11n	
ZigBee interface	O-QSPK	
Power reducer	4/6 pin control, 5V	
ZigBee		
Operating frequencies	2412 – 2462	MHz
Bandwidth	2.25	MHz
Clock frequency	38.4	MHz
Maximum RF power	18.85	dBm
Antenna gain	5	dBi
Wi-Fi		
Operating frequencies	2405 – 2480	MHz
Bandwidth	20	MHz
Clock frequency	26	MHz
Maximum RF power	11.32	dBm
Antenna gain	5	dBi
Ethernet		
Clock frequency	50	MHz
Mode operating	100BASE-TX	

Support Contact Information

If you have technical problems concerning SolarEdge products, please contact us:



<https://www.solaredge.com/service/support>

Before contact, make sure to have the following information at hand:

- Model and serial number of the product in question.
- The error indicated on the SetApp mobile application, on the monitoring platform, or by the LEDs, if there is such an indication.
- System configuration information, including the type and number of modules connected and the number and length of strings.
- The communication method to the SolarEdge server, if the site is connected.
- The product's software version as it appears in the status screen.

The SolarEdge Technologies Ltd. Limited Warranty covers defects in workmanship and materials of the below- listed products for the applicable Warranty Period set out below (the "Products"):

- **Power optimizers:** 25 years commencing on the earlier of: (i) 4 months from the date the power optimizers are shipped from SolarEdge; and (ii) the installation of the power optimizers, provided, however, that for the module embedded power optimizers (CSI and OPJ models), the Warranty Period shall not exceed the maximum of (1) the module product warranty, and (2) the module power warranty periods provided by the applicable module manufacturer.
- **Inverters, Safety & Monitoring Interface (SMI), Auto-transformer, Backup Interface:** 12* years commencing on the earlier of: (i) 4 months from the date the products are shipped from SolarEdge; and (ii) the installation of the products.
- **StorEdge Interface:** 10 years commencing on the earlier of: (i) 4 months from the date the Interfaces are shipped from SolarEdge; and (ii) the installation of the Interfaces.
- **ZigBee Gateway, Commercial Gateway, Firefighter Gateway, Smart Energy products, Wireless Communication Products, RS485 Plug-in, Energy Meter, Smart EV Charger:** 5 years commencing on the earlier of: (i) 4 months from the date the product is shipped from SolarEdge; and (ii) the installation of the product. Warranty duration of wireless communication products is the same whether or not the product is pre-installed in the inverter.

* In some countries, the inverter warranty is limited to 7 years. For a list of these countries, please access http://www.solaredge.com/warranty_exceptions

The Limited Warranty does not apply to components which are separate from the Products, ancillary equipment and consumables, such as, for example, cables, cable holders, fuses, fans, wires and connectors, whether supplied by SolarEdge or others. Some components may carry their own manufacturer warranty. See product datasheet for more details. In addition, for all power optimizers with a part number ending in C, the SolarEdge warranty does not apply to the input connector.

A complete copy of the warranty, including exclusions, limitations and other terms can be accessed at

<https://www.solaredge.com/sites/default/files/solaredge-warranty-may-2021.pdf>

If you prefer a printed copy of the warranty to be sent to you, please contact support@solaredge.com or call our support center and we will gladly provide.

solaredge