

For updates, check:



### Support Contact Information

In case of any technical issues with SolarEdge products, please contact us at: <https://www.solaredge.com/service/support>



MAN-01-00988-1.0

© SolarEdge Technologies, Ltd.  
All rights reserved.  
Version: 1.0, December 2022  
Subject to change without notice.

## What's in the Package

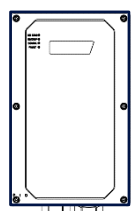

Backup Interface

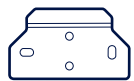

Mounting bracket

## Required Tools



Drill



Phillips screwdriver



Level



Watchmaker flat screwdriver



Torque wrench



CAT6 cable



M4, M5 Allen keys



Pencil



X 3  
Mounting screws and wall plugs

## SAFETY AND HANDLING INSTRUCTIONS

- Read this entire document before installing or operating the Backup Interface (also referred to as BUI). Failure to do so or to follow any of the instructions or warnings in this document can result in electrical shock, serious injury, or death, or may damage the Backup Interface and other property, it can also lead to warranty void.
- Do not discard this document! After installation, keep it adjacent to the Backup Interface for future reference!
- Before operating the Backup Interface and inverter, ensure that they are properly grounded. The Backup Interface and inverter must be connected to a grounded, metal, permanent wiring system, or an equipment-grounding conductor must be run with the circuit conductors and connected to the equipment grounding terminal or lead.
- Opening the Backup Interface and repairing or testing under power must be performed only by qualified service personnel familiar with the Backup Interface.

### WARNINGS!



This symbol on the product or in the accompanying documentation denotes a hazard. It calls attention to a procedure that, if not correctly performed or adhered to, could result in injury or loss of life. Do not proceed beyond a warning note until the indicated conditions are fully understood and met.



This symbol on the product denotes risk of electric shock due to stored energy. Before handling the product, wait for at least 5 seconds after disconnecting it from all sources of energy.



### DANGER!

Before opening the covers and connecting the grid, please make sure that the main CB and the Inverters are OFF.

## Main connection scheme

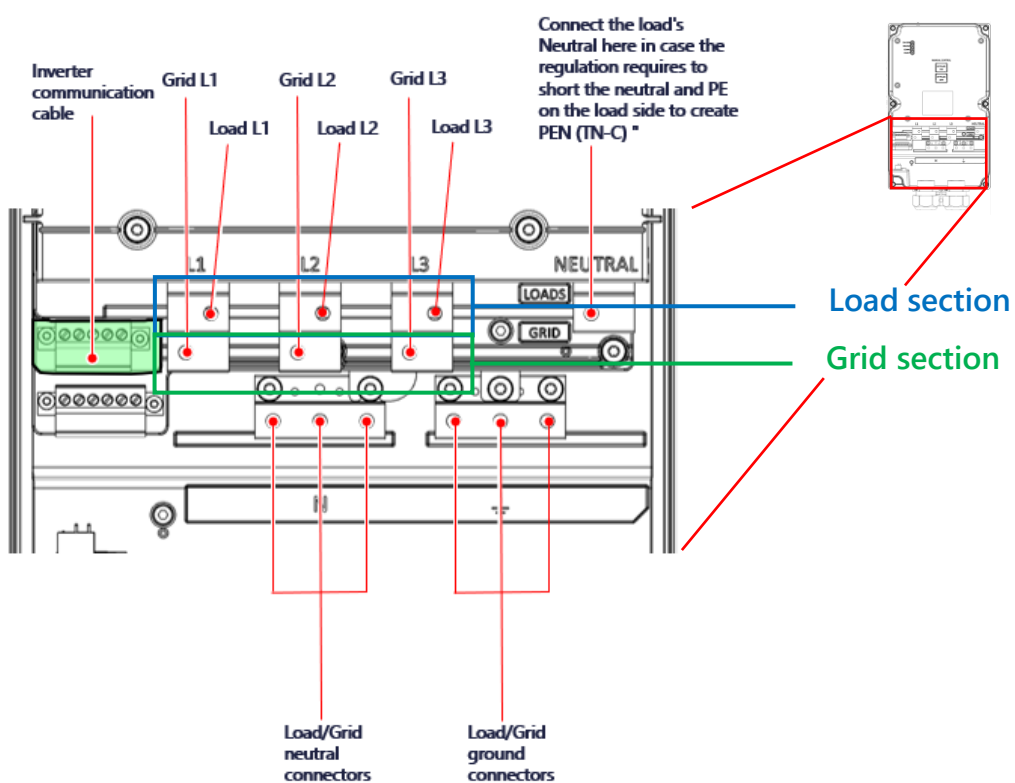

## Bottom interface of the Backup Interface

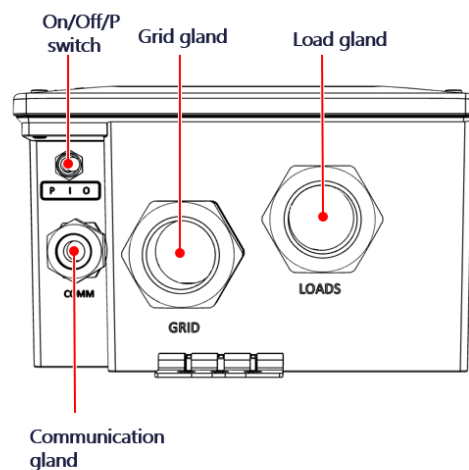

### 1 Mounting the Backup Interface

- Select an installation location. Make sure you have enough space between the Backup Interface and other objects to securely access all its interfaces.
- Install the mounting bracket to the wall and secure it with 2-4 screws. If using only 2 screws, use left and right ones.
- Hang the Backup Interface on the mounting bracket.
- Hang the lower bracket on the hook behind the bottom glands, secure it to the wall with a screw.

### 2 Removing the covers

**WARNING!**  
It is forbidden and dangerous to open the upper section. Only the lower section is for user interface usage.

- Using M5 Allen key, release six screws and remove the Backup Interface front cover.
- Using M4 Allen key, release two screws and remove the Backup Interface internal lower cover.
- Make sure the ON/OFF switch is in the OFF position.

OFF

**Cable**

Outer diameter of 25-32mm

Cable cross section of 6<sup>2</sup>-16<sup>2</sup>mm

For the Home Hub inverter installation guide, scan

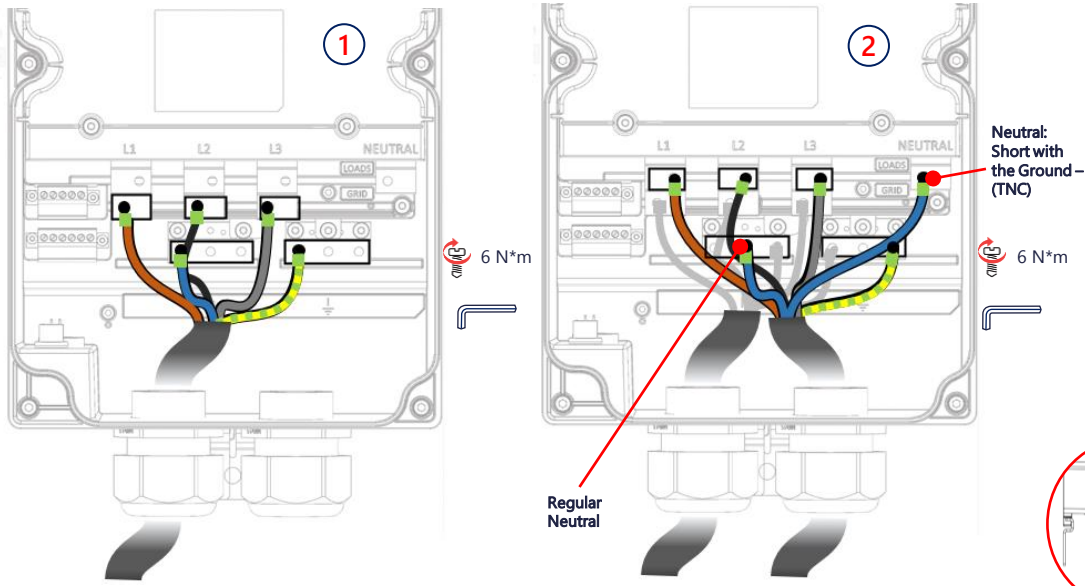

**Connecting the Backup Interface**



**DANGER!**

Before opening the covers and connecting the grid, please make sure that the main CB and the Inverters are OFF. **Note:** If your local regulations require a short between Neutral and Protective earth (e. g. according to TNC), use the upper-right terminal for the Load Neutral (see the figure below and the Main Connection Scheme).

- Strip 100mm around the external **grid** cable and strip 8mm from the internal wire insulation. If needed, crimp the wire ferrules. Open the left gland marked with "Grid" and insert the grid cable. **Connect the ground wire first.** Torque – 6nm. Connect the wires Ground (yellow) ,L1 (brown) ,L2 (black), L3 (gray), and Neutral (blue) to their respective terminals.
- Strip 100mm around the external **load** cable and strip 8mm from the internal wire insulation. If needed, crimp the wire ferrules. Open the right gland marked with "Load" and insert the load cable. **Connect the ground wire first.** Torque – 6nm. Connect the wires Ground (yellow) ,L1 (brown) ,L2 (black), L3 (gray), and Neutral (blue) and to their respective terminals.
- If your system doesn't use solaredge home network, connect the Backup Interface to your inverter using a CAT5 E or a CAT6. Open the communication gland and insert the communication cable, close the gland. Pull out the communication connector and connect the communication cable wires to the G, A, B, and 12V +/- respectively. Please use a twisted pair connection for A and B. Connect the other side of this cable to the inverter.
- Backup Interface includes a built-in meter. If you are using full house backup, you will have to disconnect any other external export/import meter and remove it from SetApp. The internal meter must be configured as import/export. If you are using partial home backup, you will have to connect and define an external meter on the main panel and define it as the import/export meter of the system.

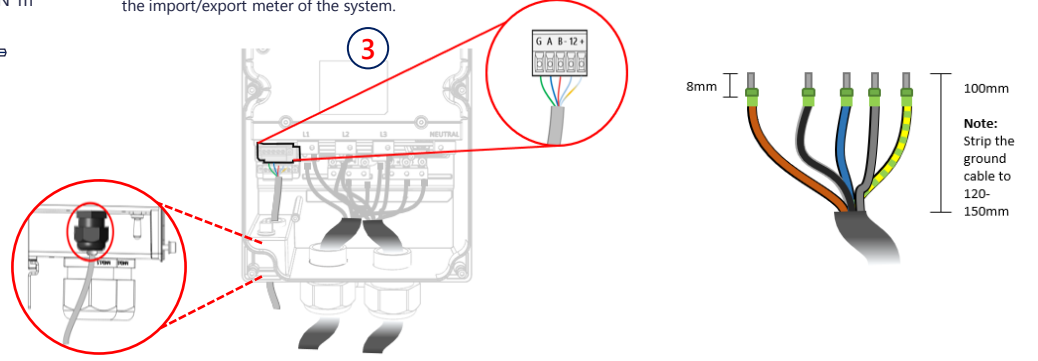

**Closing the Backup Interface**

- Using M4 Allen key, secure Backup Interface internal lower cover with two screws.
- Using M5 Allen key, secure Backup Interface external front cover with six screws.
- Now you can turn on the main CB and the inverter.

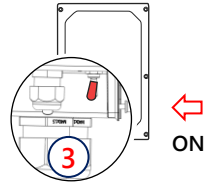
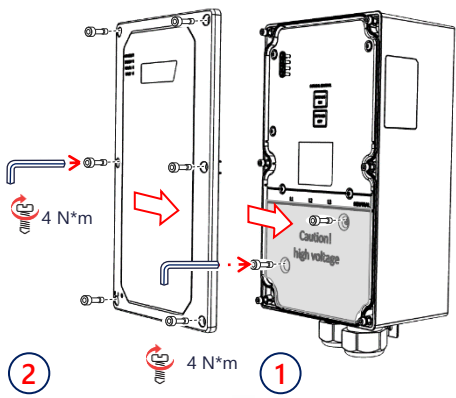

**Configuring Installation**

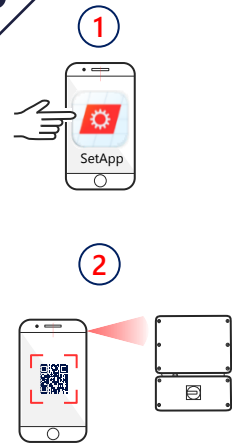

- Commissioning
- Power Control
- Energy Manager
- Backup Configuration
- Backup
- Enable

- Run SetApp.
- Scan the QR code on the inverter.
- Follow the on-screen instructions.
- Configure the import/export meter on SetApp.

**Backup system checkup**

**Note:** Before you start, make sure you have the Inverter system operating and producing with battery at above 20%. Checking the backup operation may cause 2-3 seconds of electricity supply failure to the loads before they are powered up again; if you have a load sensitive to such interruption, please disconnect it from the load backup section. Make sure the loads are evenly distributed between phases and do not exceed your inverter rating per phase.

- Make sure you have power from the grid and your inverter is working.
- Before you start, check that the Battery SoC level is above 20%.
- Make sure the Grid LED is ON and there is no fault detected. Turn OFF the main CB coming from the grid. Immediately after that, all home loads should shut down and the "On grid" LED should turn OFF.
- Wait for a few seconds till all the home loads are powered up again, the LED marked as "Backup" should turn ON.
- After a few minutes of stable operation, turn ON the main CB again.
- "Backup" LED should turn OFF and the "On grid" LED should turn on again.

**Manually Switching to Grid-Connected Mode**

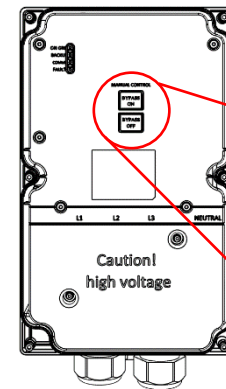

**WARNING!**

Only a certified installer is permitted to perform this operation

In case the grid is back to operation, but, for some reason, the "Backup Interface" LED shows that backup is ON, you can manually connect the grid back to the loads by following the below procedure.

When the system is manually switched to the grid-connected mode, no backup of the loads is possible.

To switch to the grid-connected mode:

- Remove the Backup Interface front cover as shown above.
- Press "Bypass On" on Manual Control panel.
- Close the external cover.

**LED Indications**

Grid	Backup	Comm	Fault	All LEDs OFF
				No power
<b>ON</b> On grid or boot	<b>ON</b> In backup or boot	<b>ON</b> Connected to the network/ received modbus packet/ boot	<b>ON</b> Fault or boot	
<b>OFF</b> Backup mode	<b>OFF</b> On grid	<b>Blinking</b> There is no communication over RF or RS485	<b>OFF</b> No faults	
<b>Blinking</b> Firmware upgrade	<b>Blinking</b> Firmware upgrade	• On RF – not connected or temporarily disconnected	<b>Blinking</b> Firmware upgrade	
<b>Fast blinking</b> Backup interface received request to identify itself	<b>Fast blinking</b> Backup interface received request to identify itself	• On RS485 – no packet received for 30 seconds		
		<b>Flickering</b> Bootloader is upgrading software		
		<b>Fast blinking</b> Device received request to identify itself		

