

Exhaust Air Heat Pump Water Heater



Manual Version 3.2

EcoStore



INTRODUCTION

These instructions are addressed to both the installer and the final user, who respectively must install and use the heat pump water heater. Failure to meet the provisions contained in this manual will result in the cancellation of the warranty.

These instructions include essential and important information for safe and proper installation, and

are an integral part of the product. Consequently, all technical documents must be kept with care and must always accompany the product.

All the data and instructions contained in this manual refer to the current technological level.

Please always refer to the instructions contained in this manual when installing the equipment.

The operations described in these instructions require specialized knowledge, achievable through a comprehensive and proven professional training in system installation.

As a consequence, we recommend that you only perform the installation operations described herein if you meet the technical requirements to install such system.

The instructions are provided in schematic form; due to possible writing/printing errors, and to possible technical changes, we decline all responsibility as to the correctness of the contents.

The diagrams used are purely **INDICATIVE**, have no pretense of completeness and are not intended to replace the design.

INDEX

1	GENERAL NOTICE	03
1.1	FIELD OF USE	04
1.2	PRODUCT NAME	06
1.3	SAFETY INFORMATION	06
1.4	CERTIFICATIONS AND MARKINGS	07
1.5	MEANING OF THE SYMBOLS USED HEREIN	07
1.6	DELIVERY AND PACKAGING	07
1.7	TRANSPORT	08
1.8	MEASURING	08
1.9	TEMPERATURE UNIT SHIFT	08
2	TECHNICAL AND DIMENSIONAL SPECIFICATIONS	08
2.1	OPERATING PRINCIPLE	08
2.2	ENERGY EFFICIENCY	09
2.3	HOT WATER TEMPERATURE	09
2.4	MAIN COMPONENTS	10
2.4.1	TANK	10
2.4.2	HEAT PUMP UNIT	10
2.4.3	ANTI-CORROSION PROTECTION	10
2.4.4	THERMAL INSULATION AND COATING	10
2.5	DIMENSIONAL CHARACTERISTICS	11
	TECHNICAL DATA TABLE	12
3	INSTALLATION AND FIRST START-UP	13
3.1	HYDRAULIC CONNECTION	14
3.1.1	HYDRAULIC SAFETY UNIT	15
3.1.2	PRESSURE REDUCER	15
3.1.3	EXPANSION TANK	15
3.2	UNIT FILLING	15
3.3	DUCT	17
3.4	ELECTRICAL CONNECTION	17
4	USAGE INSTRUCTIONS	18
4.1	SWITCH-ON	18
4.2	ELECTRONIC CONTROL	19
4.2.1	DISPLAY	19
4.3	OPERATIVE INSTRUCTION	20
4.3.1	OPERATIONS BEFORE TURNING ON THE PRODUCT	20
4.3.2	MODE	20
4.3.3	HEAT SOURCE SHIFT	21
4.4	BASIC FUNCTION	21

4.4.1	WEEKLY DISINFECT FUNCTION.....	22
4.4.2	VACATION MODE	22
4.4.3	POWER ON AND POWER OFF.....	22
4.4.4	LOCK AND UNLOCK.....	22
4.4.5	QUERY FUNCTION	22
4.5	SETTING.....	23
4.5.1	TEMPERATURE SETTING.....	23
4.5.2	CLOCK SETTING.....	23
4.5.3	TIMER SETTING.....	23
4.5.4	CANCEL.....	25
4.5.5	DISINFECT MODE.....	26
4.5.6	VACATION MODE.....	27
4.6	COMBINATION BUTTON	27
4.7	AUTO-RESTART.....	27
4.8	SCREEN AUTO LOCK.....	27
4.9	ERROR.....	28
4.9.1	ERROR CODE TROUBLE SHOOTING TABLE.....	28
4.10	FAQ.....	29
4.11	HYDRAULIC SAFETY UNIT EFFICIENCY CHECK.....	31
4.12	UNIT EMPTYING	31
4.13	RESTART AFTER A LONG TERM STOP.....	31
5	MAINTENANCE INSTRUCTIONS	32
5.1	GENERAL.....	32
5.2	FALSE ERRORS OF OPERATION	32
5.3	VISUALIZED TEMPERATURE	32
5.4	HEAT PUMP UNIT MAINTENANCE	33
5.5	CLEANING THE ASPIRATION AIR FILTER.....	33
5.6	WATER CIRCUIT / CONDENSATE DISCHARGE	33
5.7	AIR CIRCUIT SUPPLY.....	34
5.8	DESCALING AND LIMESCALE DEPOSIT REMOVAL.....	34
5.9	ANODE VERIFICATION.....	34
5.10	REPLACE AND/OR CONTROL THE ELECTRICAL RESISTANCE.....	36
5.11	OUTSIDE CLEANING.....	36
5.12	GENERAL NOTES.....	36
5.13	AFTER-SALE SERVICE.....	36
6	MEASURES TO BE ADOPTED IN CASE OF MALFUNCTIONS	37
7	ILLUSTRATIONS.....	37

1 GENERAL NOTICE

1.1 Field of use

The heat pump water heater for the production of hot water is only intended to be used for sanitary water heating, without exceeding the usage restrictions specified herein. To this purpose it must be hydraulically connected to a sanitary water delivery network. It requires a power supply to operate. Never use the heat pump for any purposes other than those specified herein. Any other use is to be deemed as inappropriate and forbidden.

The manufacturer cannot be held responsible for any installation errors and inappropriate equipment use.

1.2 Product nameplate – EcoStore CE-ES200 / CE-ES300

1.3 Safety Precautions

The purchaser shall take care of the installation. The manufacturer shall not be liable for any damages caused by wrong installation and / or non-compliance with the instructions contained in this use and maintenance booklet, and in particular with those prescribing that:

- the electrical connection must comply with the provisions specified in the relevant paragraph.
- the supplied nylon electrical protectors must be properly installed.
- “the hydraulic safety unit” must be properly installed, intact and in good working order.
- installation and maintenance must be performed by qualified personnel, in compliance with the building regulations in force.
- before starting any maintenance or repair operations on components containing any cooling fluid, a qualified technician must remove an appropriate amount of the latter, to ensure the risk-free execution of the operations in question. The refrigerant must be handled and disposed of in compliance with the relevant regulations and must not be dispersed into the environment! (The R134a refrigerant is CFC-free, not flammable and not harmful for the ozone layer);
- the maintenance regulations must be observed.
- the equipment must be installed in an appropriate room (to avoid being exposed to frost)
- the maximum overpressure, when using the tank, must be respected.
- the maximum temperature, when using the tank, must be respected.



CAUTION! FAILURE TO COMPLY WITH THE ABOVE PROVISIONS WILL RESULT IN THE CANCELLATION OF ANY WARRANTY RIGHT.


This equipment complies with the provisions contained in the EEC Directives in force.

1.4 Certifications and Markings

The verification has been performed with reference to the following technical standards:

- ✓ UNI EN 16147;
- ✓ EN 12102;
- ✓ EN 60335-1;
- ✓ EN 60335-2-21;
- ✓ EN 60335-2-40;
- ✓ EN 55014-1;
- ✓ EN 55014-2;
- ✓ EN 61000-3-2;
- ✓ EN 61000-3-3;
- ✓ EN 50366.

1.5 Meaning of the symbols used herein

Symbol	Meaning
	Failure to comply with the provision in question may result in injuries and/or damages to people, objects, plants or animals .

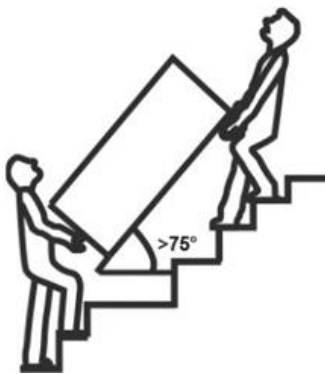
1.6 Delivery and packaging

The heat pump water heater is supplied in an environment-friendly and easy to handle cardboard packaging with protective inserts. Make sure that the packaging material is disposed of properly in compliance with the environment-related regulations in force.

Should the heat pump for sanitary water show any clear damages, absolutely avoid mounting or installing it. Immediately inform the supplier.

1.7 Transport

When storing and transporting it, always keep the heat pump water heater vertical (straight) in its original packaging. For short stretches it can be inclined by 45°, provided utmost care is taken when transporting it.

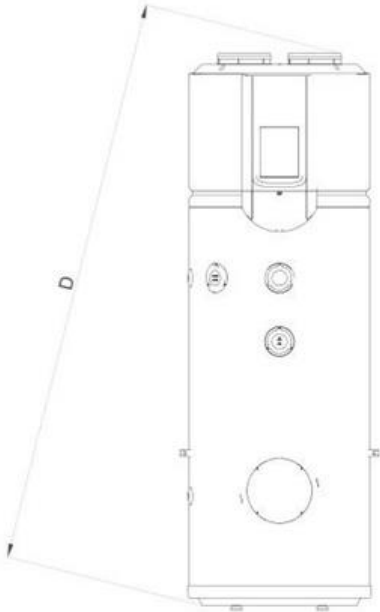


Due to the forward inclination, when using forklift trucks or other means of transport proceed slowly and fasten the equipment to prevent it from tipping.

After transporting the equipment in inclined position, before starting it you need to wait for about 3 hours, to ensure the appropriate settling of the lubricating oil in the cooling circuit and avoid damages.

When manually carrying and putting into position the heat pump, after removing the packaging you need to use the auxiliary equipment/the bracket supplied for transportation.

For short moves use the special handles situated on the side part of the product.



Model	Unit	H
EcoStore CE-ES200	mm	1664
EcoStore CE-ES300		2107

1.8 Measuring

The measuring units used in this manual for the relevant physical magnitudes are those of the International System (SI).

1.9 Temperature unit shift

Press **ENTER** for 3 seconds to unlock the buttons.

Long pressing the **E-HEATER** key for 10 seconds they can shift the temperature from display unit from '°F' to '°C' or from '°C' to '°F'

The default is '°C'. When it is shifted to display '°F', it still will display '°C' while it operates spot check.

2 TECHNICAL AND DIMENSIONAL SPECIFICATIONS

2.1 Operating principle

The all in one air to water heat pump uses the energy of the air existing in the environment. The air required for the proper operation of the heat pump can be drawn from the outside through a window (minimum temperature -20°C) / from the surrounding environment or from other environments through ducts. The air drawn from the environment is sucked through a fan and the heat existing in the air is absorbed during the passage in a heat exchanger (evaporator). In the evaporator the heat taken from the air is caused to evaporate at low pressure by the refrigerant (the working fluid in the refrigerant circuit, as in a household fridge). The vaporized refrigerant is drawn through a compressor and raised to a higher level of pressure and temperature. In a second heat exchanger (condenser) the higher temperature heat is absorbed and transferred to the water; this way the vaporized refrigerant fluid condenses back to the liquid state as a consequence of thermal dissipation. The liquid refrigerant, flowing through a choking component (expansion valve), undergoes a low-pressure expansion (dilatation) and, after returning to the evaporator, it can again draw heat from the surrounding environment.

The hot water heat pump operates at ambient temperatures ranging between -20°C and $+43^{\circ}\text{C}$.

The hot water heat pump is a connection-ready equipment whose function is heating drinkable water; it basically consists of the water tank and of the refrigerant, air and water circuit components, as well as of all the control, adjustment and monitoring devices required for automatic operation.

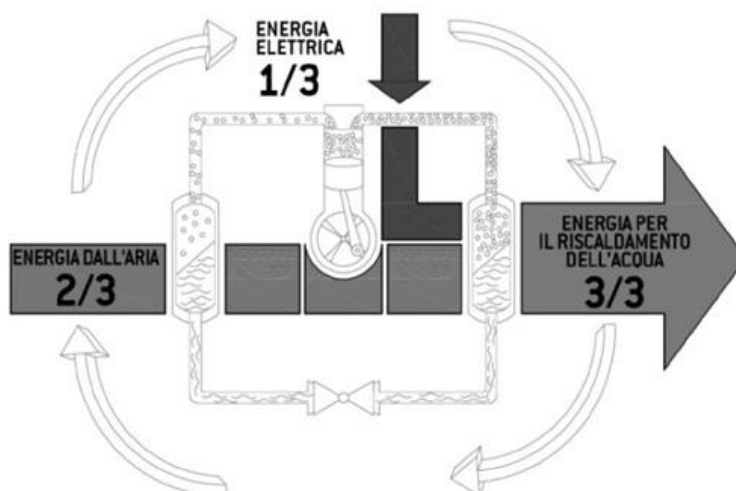
> *Use of the environment energy*

Refrigerators, washing machines, heating systems and other equipment/electric appliances generate heat that in most cases is not reused. Instead of being dispersed into the environment, generating pollution, the hot air in question can suitably be used to heat sanitary water: a sensible and environment-friendly solution.

An important benefit is the air dehumidification resulting from heat suction, decreasing the degree of humidity in cellars and laundries.

This has two beneficial effects: environment protection and production of cheap hot sanitary water.

2.2 Energy efficiency



> *Free energy*

The necessary energy for the heating of sanitary water comes for 2/3 from the air and 1/3 from the electric power supply.

> *Cooling through the heat pump for hot sanitary water*

After heat subtraction, the lower-temperature output air can be used during summer to cool the environment where the heat pump is installed.

This provides a double benefit, while ensuring optimum energy efficiency.

> *Industrial use of energy*

The heat pump for hot sanitary water can be beneficially installed in stores and workshops (hairdressers, bakers, butchers, kitchens, factories), to get hot sanitary water and, if needed, cooled air.

2.3 Hot water temperature

Setting water temperature target range: 38-65°C.

Using renewable energies and ensuring optimum energy efficiency, the heat pump for sanitary water provides an environment-friendly and cheap solution to heat water all over the year.

2.4 Main components

2.4.1 Tank

The tank consists of a water-tight unvented cylindrical inner vessel. Cylinder material inox AISI316L.

2.4.2 Heat pump unit

The refrigerant circuit is located in the upper section of the water heater and consist of:

- Refrigerant fluid R134a;
- Rotary compressor;
- Thermostatic expansion valve;
- Solenoid valve for the de-frosting cycle;
- Combined filter, drier and collector of the refrigerating circuit;
- High-power blade evaporator;
- Electronic axial fan;
- Average-sized Cu cooling pipes;
- Thermal exchanger cooper pipe wounded around the inner vessel (in this way a contact between the refrigerant gas and the drinkable water is impossible);
- Condensation drain plastic pipe.

2.4.3 Anti-corrosion protection

The protection against corrosion is performed by an integrated electronic anode.

Data:

Electronic

- Feeding 90 - 253Vac 50 - 60Hz
- Maximal absorption 3W
- Maximal output voltage 20Vdc
- Maximal output current 15mAdc
- Working temperature -10 – 85°C. • Protection level IP44
- Size 85x55x26mm

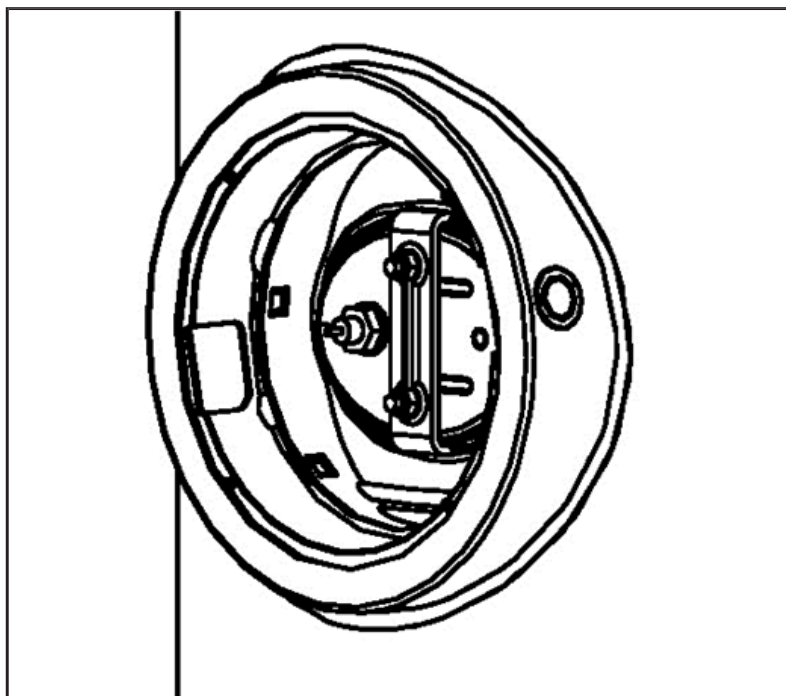
Electrode

- Protection electrode activated titanium diam. 3mm
- Fastening 1/2"
- Screwing up max. 25 Nm
- Working temperature -10 – 100°C.

Connection

- Power cable double insulation cable tmax 105°C.
- Protection cable flat cable 2x0,50mm red/black (red cable: electrode)
- electrode connection bush diam. 3mm
- tank connection eyelet diam. 5mm.

Positioning



- All fastenings connections and maintenance operations must be performed when the device is not powered or in use.
- Be sure that the device is properly positioned, far away from water, direct heat sources, etc.
- Do not open the cover of the device, there are no serviceable parts.
- Do not invert the electrical connections to the electrode.

2.4.4 Thermal insulation and coating

Thermal insulation is ensured by a highly biological, CFC-free rigid polyurethane foam (PUR) coating. The full compressed foam coating allows to minimize energy losses. The external coating is made of a soft PVC material.

2.5 Dimensional characteristics


The technical and dimensional characteristics of the equipment are indicated in Fig. 1. The electrical characteristic data of each model can be found on the equipment itself.

Model	Diameter Ø	Height	Weight
EcoStore 200	650mm	1586mm	101kg
EcoStore 300		2107mm	118kg

Heating exchanger surface:

Model	Unit	Lower heating exchanger
EcoStore 200	m ²	0.6
EcoStore 300		1.3

Technical data table

Model		EcoStore 200	EcoStore 300
Type		Exhaust Air Heat Pump	
Use		Water Heater	
Hot Water Temperature Range	JH	Standard 55°C (Minimum 38°C – Maximum 65°C)	
Storage material		(DIN 4753) AISI 316 / EN 1.4404	
Storage size	Litr	200	300
Insulation thickness	mm	50	
Power supply	V	1 – 230 – 50	
Ambient temperature	JH	-20°C min / max. +43°C	
Noise level	dB(A)	52.7	
Refrigerant type / quantity	R /	R134a/1.02	R134a/1.2
Refrigerant design pressure	MPa	3.0/1.2	
Tank design pressure	MPa	0.6	
Control		Electronic Expansion	
Program Functions		Economy / E-Heater / Holiday / Disinfect	
Protection		TCO1, TCO2, de-frosting automatic	
Air flow	M3/h	414	
Compressor Oil Type		PAG	
Heating up time	h:min	4:10	6:21
Heating up energy input	kW	2.48	3.7
Standby power input	W	32	32
Total useful energy (Q _{lp})	kWh	11.6	19.1
Total energy consumption (W _{el-p})	kWh	3.55	5.26
Reference Hot Water (θ _{wh})	°C	53.34	53.3
Rated Heat Pump Output	kW	1.527	1.527
COP _{DHW} (Tapping Cycle 20-55c from EN16147)		3.28	3.63
ErP Test Profile		L	XL
Erp Energy Class		A+	
Fan	W	68	
	r/min	620/530/465	
Water pipe	BSP	1"	
	BSP	1"	
Condenser	Diameter	Copper 0 8x0,5	
E-heater	No.	1	
	Material	Incoloy 800	
	kW	0.9	
Tank protection		Electronic Anode (DIN 4753)	
Rated Electrical Input	kW	1.1	
Rated Heat Pump Input Power	Amps	4.78	
Maximum Heat Pump Starting Current	Amps	8.69	
Maximum Input Heat Pump + Element	Amps	10	
Electrical protection	IP Rating	21	
Electrical Standards	EMC	EN6100-3-2 / EN6100-3-3	

FICHE ACCORDING TO REGULATION (EU) No 812/2013			
MODELS		EcoStore 200	EcoStore 300
Declared load profile		L	XL
Water heating energy efficiency class		A+	A+
Water heating energy efficiency	Indoor air +20°C	108%	114%
	under warmer climate condition (+14°C)	101%	106%
	under average climate conditions (+7°C)	95%	100%
	under colder climate conditions(+2°C)	92%	97%
Annual energy consumption in terms of final energy	Indoor air +20°C	944 kWh	898 kWh
	under warmer climate condition (+14°C)	1011 kWh	962 kWh
	under average climate conditions (+7°C)	1075 kWh	1022 kWh
	under colder climate conditions(+2°C)	1110 kWh	1055 kWh
Thermostat temperature settings		55°C	55°C
Sound power level, indoor L _{wa}		59 dB(A)	59 dB(A)
Precautions for installation and maintenance		Read precautions for installation and maintenance at specific chapters on user's and installation's manual.	

TECHNICAL PARAMETERS ACCORDING TO REGULATION (EU) No 814/2013			
MODELS		EcoStore 200	EcoStore 300
Daily electricity consumption Q _{elec}	Indoor air +20°C	4.36kWh	4.15kWh
	under warmer climate condition (+14°C)	4.66kWh	4.44kWh
	under average climate conditions (+7°C)	4.95 kWh	4.71 kWh
	under colder climate conditions (+2°C)	5.13 kWh	4.87 kWh
Declared load profile		L	XL
Sound power level, Indoor L _{wa}		59 dB(A)	59 dB(A)
Mixed water 40°C V40		235 l	315 l
Water heating energy efficiency	Indoor air +20°C	108%	114%
	under warmer climate condition (+14°C)	101%	106%
	under average climate conditions (+7°C)	95%	100%
	under colder climate conditions (+2°C)	92%	97%

3 INSTALLATION AND FIRST START-UP

(Qualified personnel only)

Preliminary Checks

1. The flooring beneath the unit must be able to support the weight of the unit when filled with water.
2. The unit must be sited in order to minimize noise and vibration. Care must be taken to ensure its level and the heat pump unit in free air and not able to vibrate against walls or pipework when in operation.
3. Located indoors (such as a basement, utility room or garage) and in a vertical position. Sheltered from freezing temperatures.
4. Condensate drainpipe installed and piped to an adequate drain.
5. Sufficient room to maintain the unit.
6. Sufficient air for the heat pump to function, the unit must be located in a space $>15\text{m}^3$ and must have unrestricted airflow.
7. The unit cannot be placed into any type of closet or small enclosure.
8. The site location must be free from any corrosive elements in the atmosphere such as sulfur, fluorine, and chlorine.
These elements are found in aerosol sprays, detergents, bleaches, cleaning solvents, air fresheners, paint, and varnish removers, refrigerants, and many other commercial and household products. In addition, excessive dust and lint may affect the operation of the unit and require more frequent cleaning.
9. The external air temperature must be above -7°C and below 43°C . If the external air temperature falls outside these upper and lower limits the electrical element will be activated to meet the hot water demand.
10. DHW safety valve properly installed with a discharge pipe run to an adequate drain and sheltered from freezing.
11. Filter for water coming from water mains present and accessible for maintenance
12. Water temperature limit valve or mixer tap (recommended) installed per manufacturer's instructions.
13. All piping properly installed and free of leaks.
14. Water system filled, pressurized, and drained
15. Expansion tank checked / filled with nitrogen
16. Condensate and safety valve drainage
17. Condensate drain line installation must be located with access
18. Condensate drain lines installed and piped to an adequate drain
19. The unit requires 220-240 VAC for proper operation.
20. Wiring size and connections comply with all local applicable regulations and the requirements of this manual.
21. The unit and electrical supply are properly grounded.
22. Proper overload fuse or circuit breaker protection installed.

**CAUTION!**

- **The equipment must be installed in compliance with current building regulations.**
- **Engineers installing the hot water heat pump must be qualified to do so.**
- **Observe the safety regulations.**
- **The installation environment and the electrical and hydraulic systems the equipment shall be connected to must comply with the regulations in force.**
- **You need to install the equipment at the prescribed distance from the room walls and ceiling, to ensure proper operation and for easy maintenance**
- **The floor on which the equipment is to be installed must be able to bear its weight.**
- **The equipment ventilation openings must not be obstructed.**
- **The chosen environment must be suitable for the equipment IP degree, in accordance with the regulations in force.**
- **If possible, install the equipment in a room allowing to exploit the excess heat generated by tumble-driers, refrigerators, freezers, etc.**
- **Air must be neither excessively purified nor too contaminated with dust.**
- **There must be a black water drain, with a syphon to eliminate condensation.**



CAUTION! The equipment is not intended to be used by any persons (including children) having reduced sensory or mental faculties, or lacking experience or knowledge, unless they are under the supervision of a person in charge of their safety, or they have received proper instructions regarding equipment usage.

3.1 Hydraulic connections

The assembly of the safety valves must be done in conformity to the G3 regulations in force. We recommend the integration of a filter in the cold-water supply pipes.

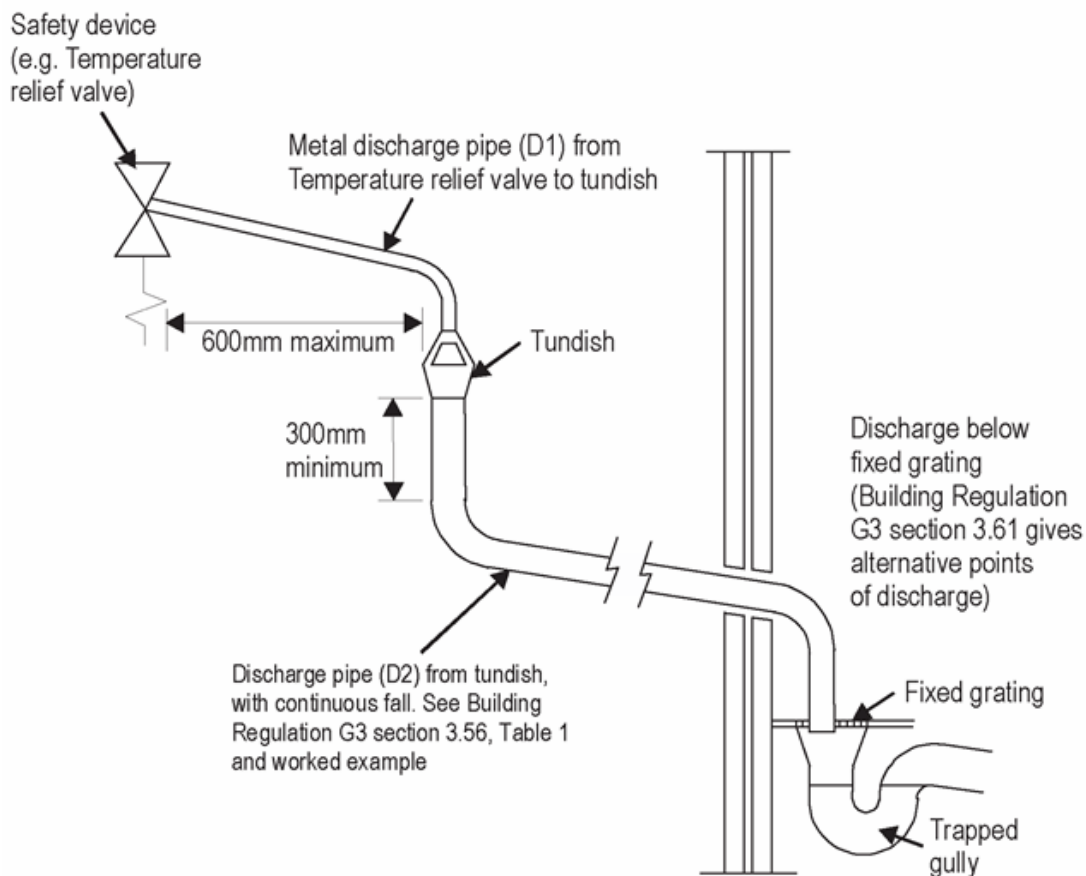
We recommend that you install the equipment close to the main hot water draw off point, to prevent heat dispersions along pipe work, and if possible, near a drain, for easier emptying and condensate discharge.

3.1.1 Hydraulic safety unit (mandatory)

You must install all **safety components supplied in the G3 kit** to comply with Building regulation G3 or with equivalent standards in force including:

- Multiblock Pressure reducing / check / safety valve
- Temperature & Pressure relief valve to cylinder
- Expansion vessel
- Tundish

The above components are required to safely run the supplied equipment. The rated calibration pressure of the temperature and pressure relief valve must be of 0.6 MPa (6 bar). Pay attention while installing the safety components, avoiding forcing or alteration. You need to install a discharge pipe, with a constant downward slope, in a condensate- and ice-free area. There must be no obstructions in the pipe, to avoid overpressures.



3.1.2 Pressure reducer

Should the network pressure exceed 0.6 MPa (6 bar), you need to install an appropriate pressure reducer upstream of the hydraulic safety unit, ensuring the indicated operating range.

3.1.3 Expansion tank

To prevent any overpressures that might damage the equipment, frequently triggering the safety unit and causing water dripping, **it is mandatory** that you install an adequate expansion vessel. Install it in accordance with the instructions provided by the manufacturer. The expansion tank is required to keep pressure constant and avoid harmful pressure shocks or accidental overpressures.

3.2 Unit filling



WARNING: Switching on the equipment when it is not filled with water will seriously damage the refrigerating units and the electrical heating element.



WARNING: In the presence of water with a hardness degree >20°TH (where 1°TH=French degree=10mg CaCo3/l) it is mandatory that you install a softener to reduce limestone scaling inside the boiler and keep the electrical resistance and the hydraulic safety unit in good working order.

To fill the equipment, you need to:

- open the main water supply valve.
- open a hot water tap (e.g. bathroom, wash basin, etc.) to allow the water to flow out; when the water outflow from the tap is constant the equipment will be full;

Check that there are no leaks from the hot / cold water system.

We recommend that you flush the pipes before connecting the unit.

Only proceed with the electrical connection after performing this operation

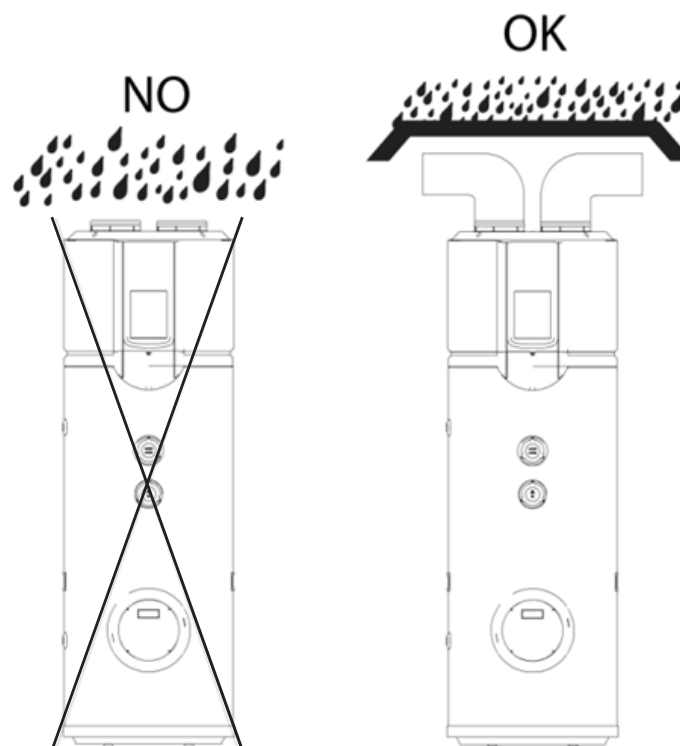
3.3 Duct

DUCT	ROUND DUCT	RECTANGLE DUCT
Dimension (mm)	0190	190x190
Straight-line pressure drop (Pa/m)	≤2	≤2
Straight-line length (m)	≤5	≤5
Bent pressure drop (Pa/m)	≤2	≤2
Bent's qty.	≤5	≤5

- The resistance of duct will decrease air-flowrate, which will lead to capacity of unit decreased.
- For the case of unit with canvas, of the duct total length should be no more than 5m or the maximum static pressure should be within 25Pa, and the quantity of bending should be no more than 3.
- For unit air outlet with duct, when unit operating, condensate will be generated around outside of duct. please pay attention to the drainage work, we suggest wrapping the thermal insulated layer around outside of the duct.
- It is recommended to install the unit in an indoor space, it is not allowed to install the unit where it can be rained on.



WARNING: In case of rain entering to internal components of the unit, the component might be damaged or causing physical danger. In terms of the unit connect with duct reaching to outdoor, a reliable water-resistant measure must be conduct on the duct, to prevent water from dropping into internal of the unit.



3.4 Electrical connection



WARNING: The equipment is already factory-wired and is equipped with a 3-core flex for the connection to an outlet having appropriate electrical characteristics.
Verify that the mains voltage complies with the value specified in the label applied on the equipment, and that the mains can supply the specified power.

To disconnect the equipment from the mains you need to use a two-pole switch complying with the EN standards (contact opening 3mm, preferably equipped with fuses). The connection must be established by inserting the plug into the appropriate outlet or hard wired to a switch. Connections must comply with **BS7671:2018** or the regulations in force.



WARNING: Switching on the equipment when it is not filled with water will seriously damage the refrigerating units and the electrical element.



WARNING: If the supply cable is damaged, it must be replaced by the manufacturer or by its technical support service, or by a person having a similar qualification, to prevent any risk or danger.

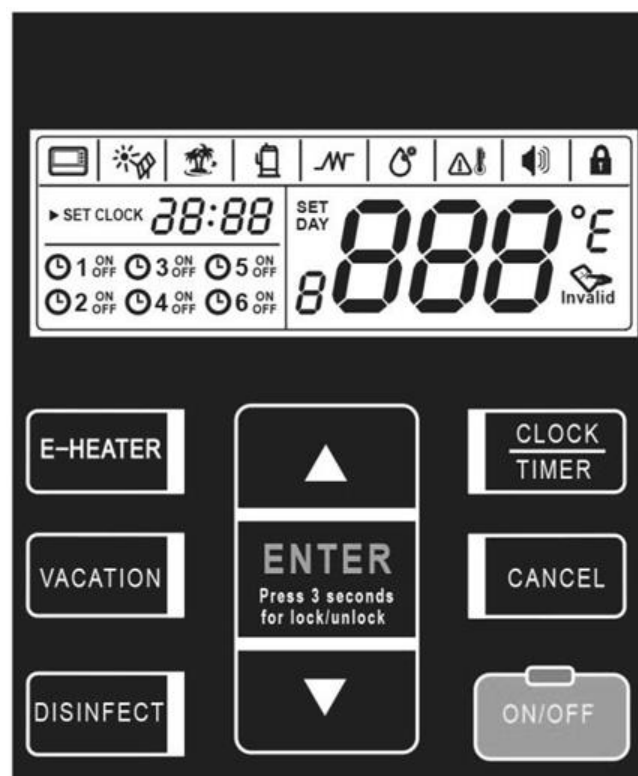
4 USER INSTRUCTIONS

4.1 Switch-on

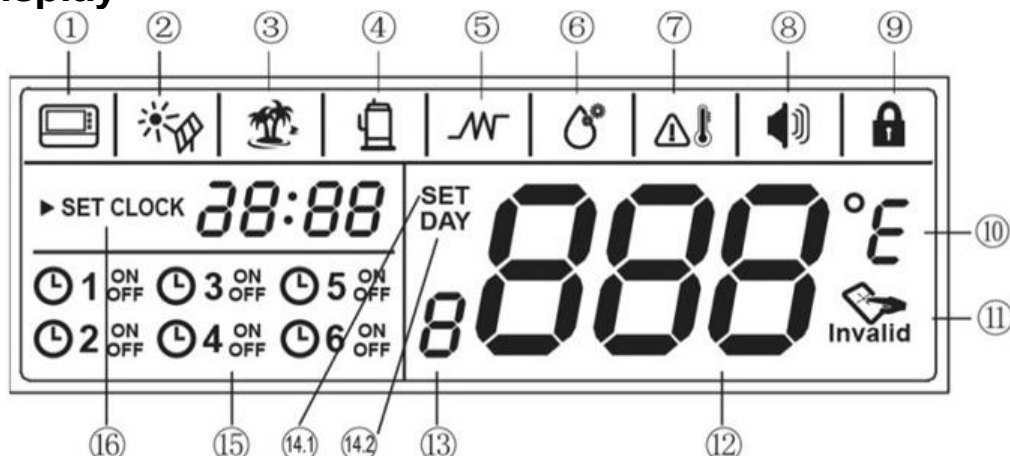
⚠ WARNING: Before switching on the equipment, always verify the electrical connections are correct; also check that the tank is filled with water, to avoid seriously damaging the refrigerating unit and the electrical heating elements.













4.2 Electronic control


The heat pump water heater is equipped with an electronic control system for the management of the temperature and of the supplementary E-Heater.



4.2.1 Display



N.	ICON	DESCRIPTION
1		Wire controller If connected a wire controller, it will be lightened; otherwise it will be extinguished.
2		Outside solar heat source If an outside solar heat source has been connected to the unit, it will flash with 1 Hz frequency; otherwise it will be extinguished.
3		Vacation mode It will be lightened if the unit is under vacation mode, otherwise it will be extinguished; it will flash with 2Hz frequency when setting
4		Compressor Icon will be lightened when compressor is running, otherwise will be extinguished.
5		E-heater It will be lightened if e-heater is activated, otherwise it will be extinguished. If e-heater is automatically activated by unit, it will be lightened; If e-heater is manually activated, it will flash with 1Hz frequency.
6		Disinfect It will be lightened when the unit is under disinfect mode, otherwise it will be extinguished. It will be lightened if disinfect mode is automatically activated by unit; It will flash with 1Hz frequency, if disinfect mode is manually activated. It will flash with 2Hz frequency when setting disinfect mode or setting
7		High temp. Alarm If setting water temp. is higher than 50°C, it will be lightened, otherwise it will be extinguished.
8		Alarm When unit is under protection/error, it will flash with 5Hz frequency as well as buzzer will sound 3 times every 1 minute until protection/error eliminated or press CANCEL for 1 second.
9		Lock If button is locked, will be lightened, otherwise it will be extinguished.
10		Temperature unit If setting temperature unit as Celsius, °C will be lightened, 888 will show Celsius degree. If setting temperature unit as Fahrenheit, will be lightened, 888 will show
11		If button is under lock mode, press any button except unlock button, it will be lightened;
12		It will be lightened if screen is unlocked. It shows water temperature on normal mode. It shows remaining vacation days on vacation mode; It shows setting temperature under setting

		It shows unit setting/running parameters, error/protection code under query mode.
13	8	Reserved
14.1	SET	Water Temperature setting It will be lightened when setting water temperature or setting days for vacation.
14.2	DAY	Date setting: It will be lightened when setting days for vacation; It will be lightened when under vacation mode.
15		Timer: 6 timers may be set. If any timer was set, the correspondent icon will turn on when the display is unblocked. If no timer was set, the icons are off. If the timer is set, the correspondent icon flashes with a frequency of 2 Hz as well as the timer that was set.
16	▶ SET CLOCK 28:88	Clock and clock setting It shows the clock. Whenever there is any setting for clock, SET CLOCK will be lightened.

4.3 Operating instructions

4.3.1 Operations before turning on the product

- When the product is turned on for the first time, all indicators on the UI will turn on for 3 seconds, and at the same time an acoustic sound will be heard. After a minute without any other operation, all buttons are blocked apart from UNLOCK button. Press it for 3 seconds to unlock the buttons.
- When the tank is filled and all the settings set, press the ON/OFF button and start the equipment.
- When the equipment is working, if no keys are pressed and there is no malfunction for 30 seconds, the display will be locked apart from the error codes and alarm lights. Press any button to unlock the display.

4.3.2 Mode

Modes will be automatically selected by unit. Manually mode selection is unavailable. Setting water temperature target range: 38÷65°C.



E-heater running ambient temperature range: -20÷45°C.

Heat pump running ambient temperature range: -7÷45°C.



Ambient Temp.	TA<-7	-7≤TA<-2	-2≤TA<2	2≤TA<7	7≤TA<35	35≤TA<43
Max. Temp. (Heat pump)	-	42	47	55	65	60
Max. Temp. (E-heater)	65	65	65	65	65	65

4.3.3 Heat source shift

The default heating source is the heat pump.

- If ambient is range out of heat pump, heat pump will stop running, the unit will shift automatically to activate E-heater and show the icon LA (L ); on the display, then if the ambient temperature goes into the running range of heat pump again, it will stop E-heater and shift automatically to heat pump again, and the icon LA(L  will be extinguished.
- If the target setting water temperature is higher than Max. temp(Heat pump), the unit will activate the heat pump firstly to the Max. temperature, then stop heat pump, activate E-heater to continually heat water to the target temperature.
- If manually activate the E-heater running mode when heat pump running, E-heater and heat pump will work together until the water temperature gets to target temperature. So, if want to heat quickly, please manually activate E-heater.

NOTE: E-heater will be activated once for the current heating progress, if want to apply E-heater again, please push **E-HEATER**.



- If system occurs some malfunctions, error code "E7" and  will be shown on the display, then heat pump will stop running, and the unit will activate automatically E-heater as the backup heat source, but the code "E7" and  will be shown until power off.

Note: If only the electric element is used as a heating source, only one part of the cylinders content will be heated; the water temperature must be set at a higher value that the one for the running of the heat pump.

- Defrosting during water-heating.
In the heat pump running period, if the evaporator frosted in lower ambient temperature, the system would defrost automatically to keep effective performance (circa 3~10 min.). At defrosting time, the fan motor will stop, but compressor will still run.
- COP
The COP (Coefficient of Performance) varies when the environmental temperature varies. Normally, lower is the environmental temperature, higher will be the water heating.
- When the environmental temperature is inferior to 2°C, the heat pump and the electric element work together order to reach the planned temperature (see the chart).

4.4 Basic function


4.4.1 Weekly disinfect function

Under disinfection mode unit immediately start to heat water up to 65°C to kill the potential legionella bacteria inside water of tank, " icon will light on the display screen during disinfection; Unit will quit disinfection mode if water temperature is higher than 65°C and extinguish " icon.

4.4.2 Vacation mode:

After pressing "Vacation" button, Unit will automatically heat water to 15°C for the purpose of energy saving during vacation days.

4.4.3 Power On and power Off

Press "ON/OFF" () button after all the above have finished and the system will run as the setting. And simply press the same button to stop it.



4.4.4 Lock and unlock

In order to prevent wrong operation, a special lock function has been design. If there is no operation for 1 minute, the unit will be locked automatically, and display the lock sign (Lock indicator lights up). When the unit is locked, no keys can be operated.



4.4.5 Query function

For the convenience of maintenance and debugging, the query function is available by Pressing 2 buttons together. **E-HEATER** + **DISINFECT**, then system running parameters will be shown one by one with following sequence by each pushing of "▲" or "▼" button.

N.				TEMP./DASYS	EXPLENATION
1	t	5	U	Temp.	T5U
2	t	5	L	Temp.	T5L
3		t	3	Temp.	T3
4		t	4	Temp.	T4
5		t	P	Temp.	Tp
6		t	h	Temp.	Th
7		C	E	Current	Compressor
8	1				Last error
9	2				Previous 1st error or protection code
10	3				Previous 2st error or protection code
11					Software number



4.5 Setting

4.5.1 Temperature setting

The temperature displayed is the water temperature in the upper part of tank.

Method for temperature set:



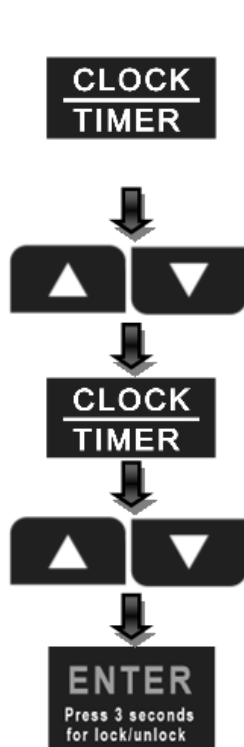
Press the  button to increase the temperature, press the  button to decrease.



Confirm setting.

4.5.2 Clock setting

The clock is for a 24-hour system and the initial time is 00:00. To make a better use of this unit, it is recommended to set the time for accurate local time. Every time powered off, the clock will be reset to initial time 00:00.

Method for time set:



Press button  for 5 sec to enter clock setting. Then icon  SET CLOCK will be lightened and the hour value of clock will flash slowly

Set the hour value of clock.

Confirm the hour setting. Then the minute value of clock will flash slowly.

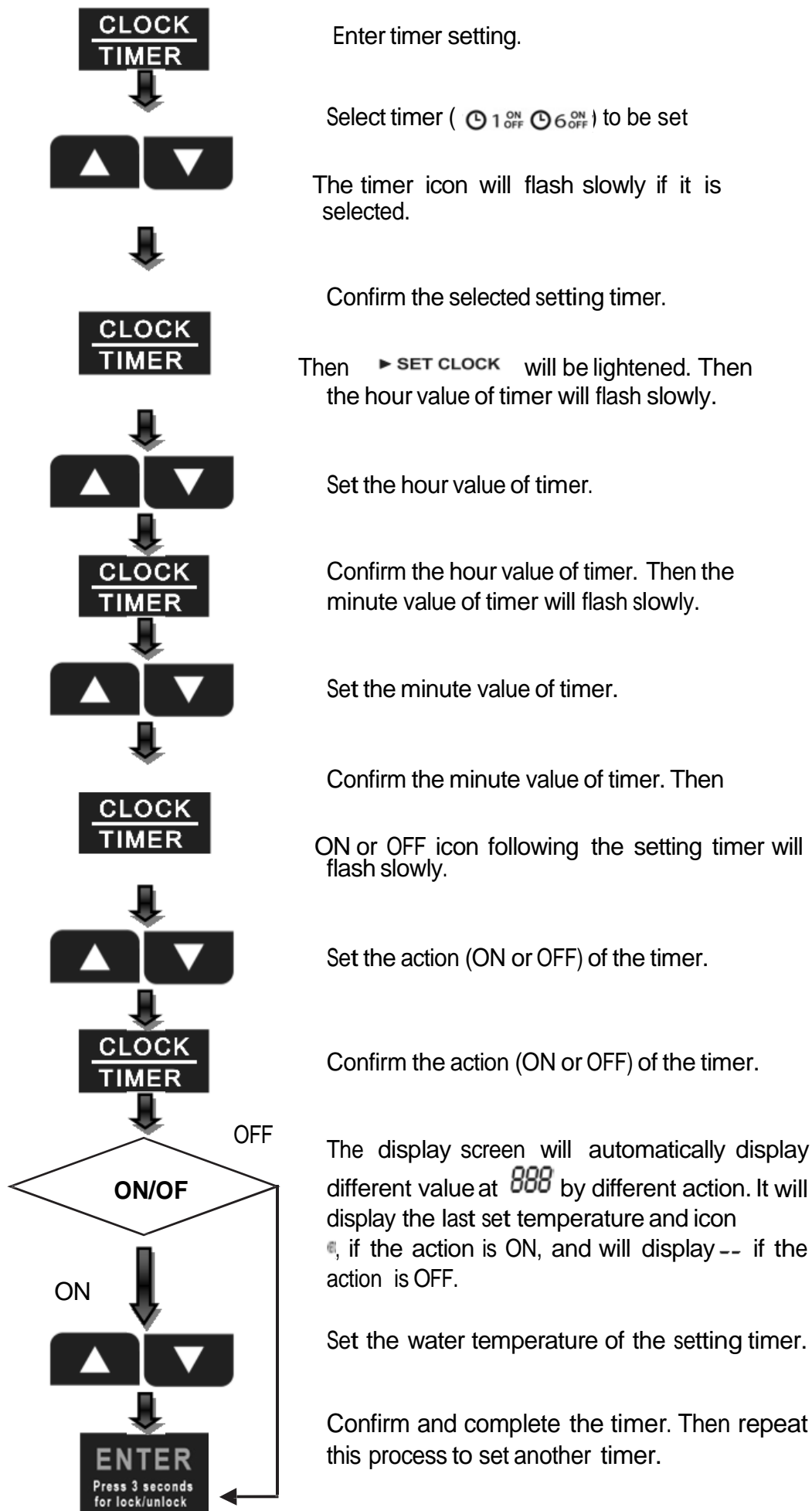
Set the minute value of clock.

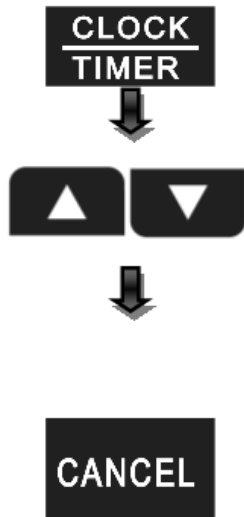
Confirm the minute setting and quit clock setting.

4.5.3 Timer setting

User can set up running start time and stop time on a specifically by the timer function. The lowest setting of timer is 10 minutes.

Method for timer setting:




Method for cancel timer setting:

Enter timer setting.

Select the timer (🕒 1 ON OFF 🕒 6 ON OFF) which needs to be cancelled. The timer icon will flash slowly if it is selected.

Confirm to cancel the timer. Then repeat selecting timer and cancelling. If the timer has not been set, when press button **CANCEL** the

display will show  Invalid. After complete cancelling timer, press button **CANCEL** for 3sec to quit timer cancelling.

Method for check timer setting:

Select time (🕒 1 ON OFF 🕒 6 ON OFF) which needs to be checked. The timer icon will flash slowly if it is selected, and the timer action (ON or OFF) and set clock will be shown. If the action is ON, target temperature will be shown. And if the action is OFF, icon -- will be shown.

Press button **CANCEL** for 3sec or no button pressing for 30sec to quit timer checking.

If there is conflict between Timer Setting and Manual On Setting:

1. The moment of Manual ON has priority.
2. The moment of timer OFF has priority.

4.5.4 Cancel

To cancel setting, quit setting, clear alarm, etc. press **CANCEL** button. To clear alarm buzzer, need to press same button for 1sec.

4.5.5 Disinfect mode

Manually turn on disinfect function:

DISINFECT



Icon  will flash

↓
ENTER
Press 3 seconds
for lock/unlock

Confirm manually activate disinfection function, then the unit will heat up water to 65°C at least for disinfection.

Disinfect Clock Setting:

DISINFECT

Press button **DISINFECT** for 3 sec. To enter in the hour settings of Disinfect modality. The icon  flashes, the icon  **SET CLOCK** lightens and the hour indicator starts to flash slowly.

↓
↑ ↓

Set the hour value of clock.

↓
CLOCK
TIMER


Confirm the hour setting. Then the minute value of clock will flash slowly.

↓
↑ ↓

Set the minute value of clock.

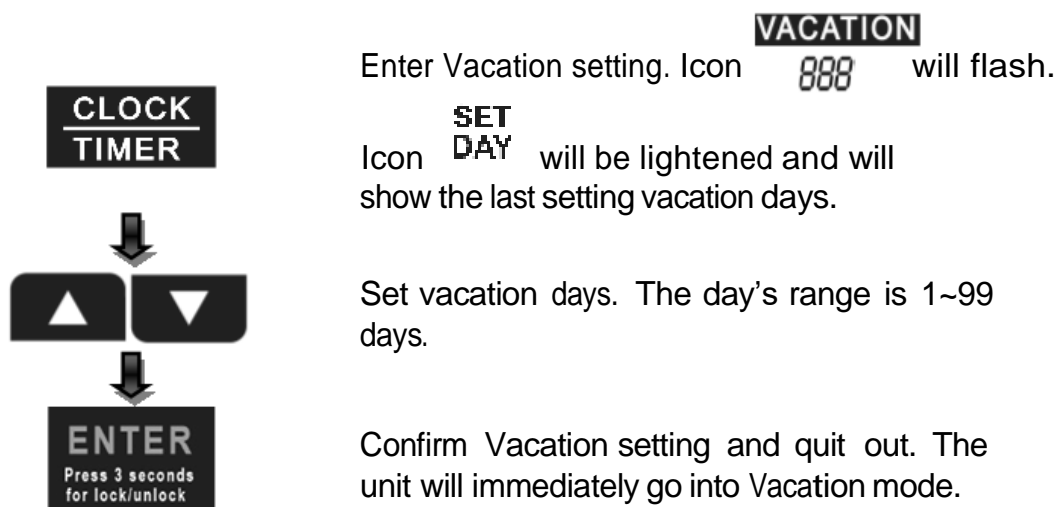
↓
ENTER
Press 3 seconds
for lock/unlock


Confirm the disinfect clock setting and quit out.

Unit will automatically start dis-infect function at the above-set clock every 7 days. If user does not set dis-infect clock, unit will automatically start dis-infect function at 23:00 every 7 days. If unit is OFF or under disinfect mode, press **DISINFECT** will lead to show  **Invalid** on the display.







4.5.6 Vacation mode

Method for Vacation mode setting:



In vacation mode, the setting target water temperature is 15°C as default and *888* will show the remaining vacation days. On the last day of vacation, unit will automatically start dis-infect function, and automatically reset the target temperature to the last one before vacation. If unit has already been under vacation mode or OFF, press **VACATION** will lead to show invalid icon  on the display.

4.6 Combination button

	ICON	DESCRIPTION
Clear error code	 + 	Press the two buttons at the same time to clear all stored error & protect codes, and the buzzer will buzz one time.
Query mode	 + 	Press the two buttons at the same time for 1sec to go into query mode. Under query mode user can check unit setting & running parameters by pressing   circulatory. Press button for 1s or no button CANCEL operation for 30s, then quit query mode.

4.7 Auto-restart

If electricity power fails, unit can memorize all setting parameters, unit will be back to the previous setting when power recover.

4.8 Screen auto lock

If there is no operation of buttons for 30s, screen will be locked (extinguished) except for error code and alarm light.

Press any button will unlock the screen(lighten).

4.9 Error

If some errors happen, the buzzer will buzz 3 times every other minute. Press **CANCEL** for 1 sec to stop the buzzer but the alarm icon will keep blinking.

When an error is verified, although in some conditions it may function, it cannot reach the expected efficiency. Please contact the supplier.

4.9.1 Error code shooting table

DISPLAY	MALFUNCTION DESCRIPTION	CORRECTIVE ACTION
E0	Error of sensor T5U(upper water temperature sensor)	Maybe the connection between sensor and PCB has released or sensor has been broken. Contact a qualified person to service the unit.
E1	Error of sensor T5L(lower water temperature sensor)	Maybe the connection between sensor and PCB has released or sensor has been broken. Contact a qualified person to service the unit.
E2	Tank and Wired Controller communication error	Maybe the connection between controller and PCB has released or PCB has been broken. Contact a qualified person to service the unit.
E4	Evaporator temperature sensor T3 error	Maybe the connection between sensor and PCB has released or sensor has been broken. Contact a qualified person to service the unit.
E5	Ambient temperature sensor T4 error	Maybe the connection between sensor and PCB has released or sensor has been broken. Contact a qualified person to service the unit.
E6	Compressor discharge temperature sensor TP error	Maybe the connection between sensor and PCB has released or sensor has been broken. Contact a qualified person to service the unit.
E7	Heat Pump system error If any of P3/P4/P2/P1 continuously appear 3 times within single heating cycle, system will consider it as "Heat Pump system error"	Contact a qualified person to service the unit.

E8	Electric leakage error If PCB current induction circuit check the current difference between L,N 14mA, system consider it as "electric leakage error"	Maybe some wires have been broken or bad wire connection. Contact a qualified person to service the unit.
E9	Compressor suction temperature sensor TH error	Maybe the connection between sensor and PCB has released or sensor has been broken. Contact a qualified person to service the unit.
EE	E-heater open-circuit error IEH (Current difference E-heater on & e-heater off <1A)	Maybe the E-heater has been broken or bad wire connection after repair.
EF	Clock chip error	Maybe the chip has been broken, but unit can work well without clock-memory, so it is needed to reset clock when power put on again. If necessary, contact a qualified person to service the unit.
Ed	E-EEPROM chip error	Contact a qualified person to service the unit.
P1	System high pressure protection: • ≥ 2.76 MPa, active. • ≤ 2.07 MPa, inactive.	Maybe because of system blocked, air or water or more refrigerant in system (after repair), water temperature sensor malfunction, etc. Contact a qualified person to service the unit.
P2	High discharge temperature protection • $T_p > 115$ °C, protection active. • $T_p < 90$ °C, protection inactive.	Maybe because of system blocked, air or water or less refrigerant(leakage) in system (after repair), water temperature sensor malfunction, etc. Contact a qualified person to service the unit.
P3	Compressor abnormally stopped protection. The discharge temperature is not so higher than evaporator temperature after compressor running a term.	Maybe because of compressor broken or bad connection between PCB and compressor. Contact a qualified person to service the unit.
P4	Compressor overloaded protection (10 sec. after compressor startup, Current checking starts: • an only compressor running if it is $>10A$, the compressor will be stopped and protected. • Compressor + e-heater opened if it is $>IEH+10$, the compressor will be stopped and protected.)	Maybe because of compressor broken, system blocked, air or water or more refrigerant in system (after repair), water temperature sensor malfunction, etc.

LA	<p>When the ambient temp T4 is out of Heat Pump running range (-7~43 °C) Heat Pump will stop, unit will show LA on the position of clock on display until T4 back to (-7~ 43 °C).</p> <p>Only valid for the unit without e-heater. Unit with e-heater will never show "LA".</p>	It is normal, and no necessary to repair.
----	---	---



CAUTION: The diagnostic codes listed above are the most common. If a diagnostic code not listed above is displayed, contact technical support for assistance referencing the number on the this manual.

4.10 F A Q

D. Why compressor can't start immediately after setting?

R. Unit will wait for 3 min to balance the pressure of system before start compressor again, it is a self-protection logic of unit.

D. Why sometimes the temperature shown on the display panel decreased while unit is running?

R. When the upper tank temperature is much higher than the bottom part, upper part hot water will be mixed by the bottom cold water which is continually flow from inlet tap water so that will decrease the upper part temperature.

D. Why sometimes the temperature shown on the display decreased but unit still keep closed?

R. To avoid unit ON/OFF frequently, unit will activate heat source only when bottom tank temperature is lower than setting temperature for at least 5 °C.

D. Why sometimes the temperature shown on the display will decreased dramatically?

R. Because tank is pressure-bearable type, if there is massive hot demand, hot water will quickly tapped out from upper part of tank as well as cold water will quickly tapped into bottom part of tank, if the cold water surface emerge the upper temperature sensor, temperature shown on the display will decreased dramatically.


D. Why sometimes unit shows "LA" on display?

R. The heat pump available running ambient range is -7÷43°C, if ambient temperature is out of range, system will show abovementioned signal to let user notice it.

D. Perché a volte il display non mostra niente?

R. Per preservare la durata del display, se non è stato premuto nessun pulsante da 30 sec, il display si spegnerà.

D. Why something there is nothing shown on the display?

R. If there is no operation on panel for 1 min, unit will lock the panel, shows . To unlock the panel, please press the **ENTER** button for 3 seconds.

4.11 Hydraulic safety unit efficiency check

The hydraulic unit efficiency is very important to prevent any overpressures inside the tank (that would damage it), and allows the user to safely operate the equipment. Periodically check the efficiency of the hydraulic safety unit, according to the instructions provided by the manufacturer. Follow the instructions provided by the manufacturer.

4.12 Unit emptying

Should the unit be going to remain unused for a prolonged time, we recommend that you empty it. In this case proceed as follows:

- cut off the power supply and the main water supply.
- open a hot water tap to allow air to flow in.
- turn the drain valve at the lowest point to the open position.

4.13 Restart after a long term stop

When the unit is restarted after a long term shutdown (trail running included), it is normal that outlet water is unclean. Keep the tap on until the water runs clean and free of debris.

5 MAINTENANCE INSTRUCTIONS

(Qualified personnel only)



WARNING: the repair and / or maintenance operations must only be performed by qualified personnel, exclusively using genuine spare parts. Before performing any maintenance operations, disconnect the equipment from the mains.
Before performing any maintenance operations we recommend that you purchase any spare parts from the authorized dealers or directly from the Manufacturer.

5.1 General

- Check the connection between the supply plug and or wiring.
- In some cold areas (under 0°), if the system is not used for a long period, empty the tank / system to prevent freezing.
- It is advised to regularly clean the inside part of the tank and the electric resistance element in order to preserve the efficiency.
- Check anode and change if needed.
- Clean the air filters each month in order to preserve the heating performance.
- Before turning off the system for a long period you must:
 - Isolate the power and water supply.
 - Drain all the water from the tank and the pipes.
 - Close all valves.

5.2 False errors of operation

- Due to a start caused by a voltage drop, you must wait 3 minutes before the reactivation of the compressor, in order to preserve its integrity.
- If the auto protection is activated and the system stops, control that:
 - When the supply indicator is on if the system is being forced to function even without the normal operative conditions; if the in-out air flow is blocked or if a strong wind blows towards the air exit.
- De-frosting
When there is humidity and cold, the condenser must be thawed and the efficiency of the air heating is lower: the system will stop the water heating, carry out an auto defrost and then will restart heating.
- During the defrosting, the compressor continues to work, while the fan stops.
- The defrosting time varies between 3 and 10 minutes accordingly to the environmental temperature and frosting.

5.3 Visualized temperature

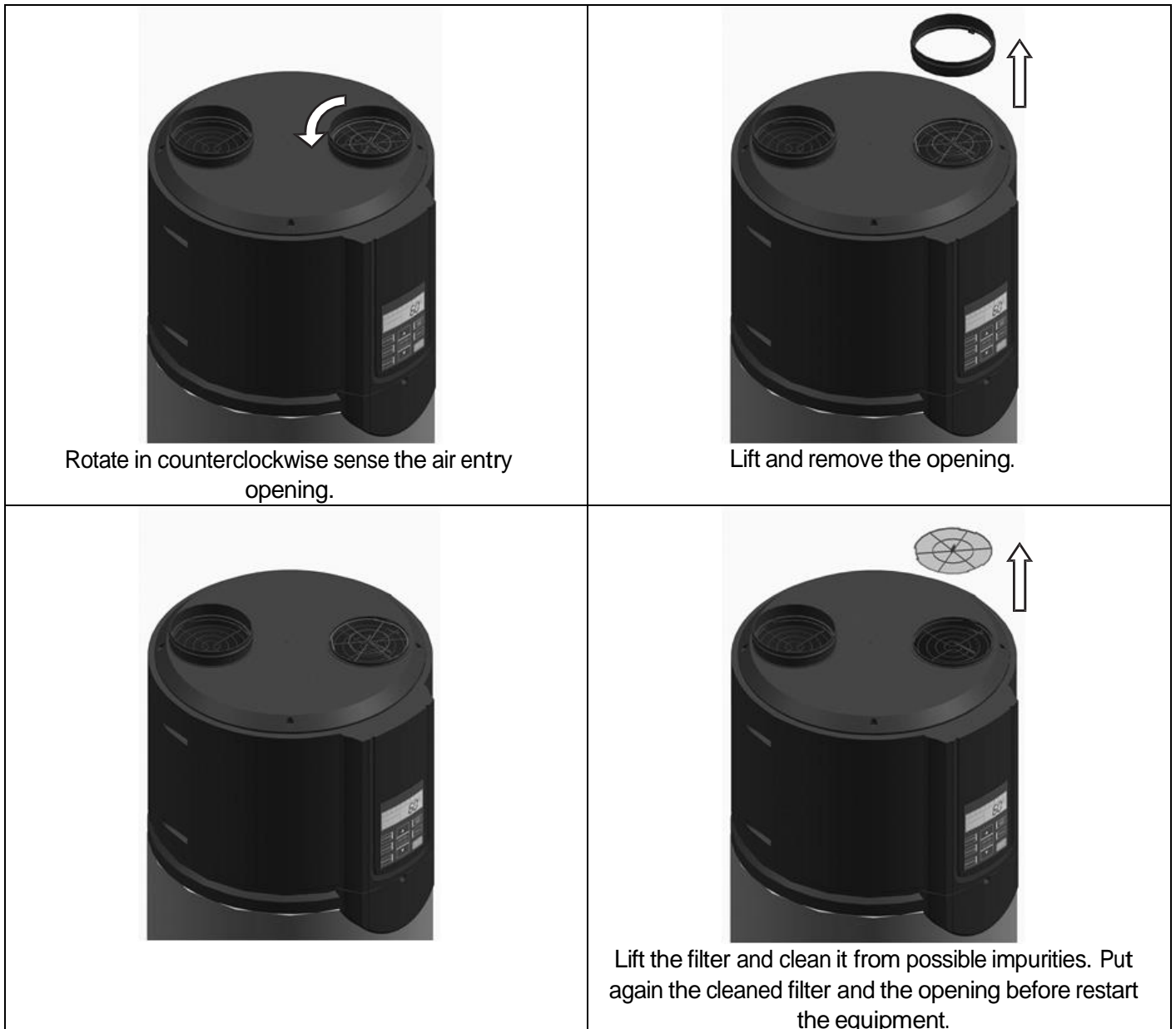
- When the system is stopped, a reduction of the temperature is normal due to the loss of heat. When it goes below a few degrees, the system is automatically activated.
- During the heating, the water temperature could continue to decrease or could not increase because of the exchange water heating. When the whole tank will get to the temperature the system will stop automatically.

5.4 Refrigerating unit maintenance

The refrigerating circuit requires no maintenance.
Components are cleaned during the anode and tank maintenance.

5.5 Cleaning the aspiration air filter

Periodically the filter placed in the air entry opening is removed and cleaned in order not to damage the system efficiency.



5.6 Water circuit / Condensate discharge

The water circuit check is limited to the integrated filter installed by the customer (if any; in this case follow the instructions provided by the valve manufacturer); also check the tightness of the valves, and of the screw connections, etc.; should they be loose, have them tightened by technicians.

As to the condensate drain, you have to check its operation, the condensate elimination (transparent plastic pipe), the tightness and the presence of any impurities at the pipe ends, cleaning them if needed.

5.7 Air circuit supply

Maintenance operations only include the cleaning of the evaporator, when needed or at the end of each shift, when checking the protective anode.



WARNING: Danger of injuries due to the presence of sharp edge blades. The blades must not be deformed or damaged – (comb blades of the condenser).

5.8 Descaling and limestone deposit removal (periodic)

Since almost anywhere deposits of limestone can be formed, verify the infiltrations of dirty water and for hygienic motives, the inside tank should be controlled and checked by a qualified person at least after the first 2 years of use, but however when the production of hot water decreases.

The limestone deposits reduce the tank volume, so also the transmission capacity of the heat exchanger and the production of hot water are reduced.

Maintenance must be done by qualified personnel.

For an accurate and competent maintenance of the inner tank it is necessary to have free access to the flange in order to control and clean the inner tank.

5.9 Anode verification (periodic)

The device is protected against corrosion by an electronic anticorrosion anode for protection against the effects of spurious currents that could damage it.

The control is performed **without** clearing out the tank.



L1 Blue	L2 Green	Signaling
OFF	OFF	Not powered device
ON/lightening	ON/lightening	Working device / right protection
lightening	lightening	Short circuit electrode (simultaneous lightening)
lightening	lightening	Disconnected electrode / no water (alternate lightening)

You must replace the anode in case of wrong working.



CAUTION: a wrong functionality of the anode reduces the last of the device.

In case of necessary substitution of the anode please do the following operations:



Procedure:

- Switch off the device.
- Disconnect the device from electrical supply
- Drain the device (see par. 4.12) until the water level is lower than the height of anode junction.
- Unscrew the screws and remove the plastic cover.
- Disconnect the earth wire
- Disconnect the protection cable from the anode.
- Remove and replace the anode.
- Disconnect the electronic control from power connections.
- Remove and replace the electronic control.
- Restore the connection between electronic control and power.
- Restore the earth wire connection.
- Restore the connection of the protection cable with the anode.
- Replace and fix the plastic cover.
- Re-fill the tank.
- Verify that there is no water leakage from joints.
- Restore the connection to the electrical supply.
- Switch on the device.

5.10 Replace and / or control the electrical resistance element

If the replacement of the electric resistance of integration is needed, follow the procedure here described.

**Procedure:**

- Turn off the appliance.
- Disconnect appliance from the electrical supply
- Empty the tank (see par. 4.12) until the water level is lower than the place where the electric resistance element is installed.
- Unscrew the and remove the plastic cap.
- Disconnect the cable from the electric resistance element.
- Remove and replace the electric resistance element.
- Check that there are no water leaks from the fitting.
- Re-connect electrical cable.
- Replace the plastic cap.
- Fill the tank.
- Restore the electrical supply to appliance.
- Restart the heat pump system.

5.11 Outside cleaning

For the cleaning of the outer shell only use soapy solutions, avoiding abrasive products containing organic thinners (alcohol, benzine, etc.).

5.12 General notes

Always use tools that are appropriate for the intended purpose.

Always replace the gaskets and/or the O-rings to ensure the hydraulic sealing remains intact when replacing components. Only use genuine spare parts.

When installing spare parts make sure that:

- the resistance element is properly housed, and the sealing gaskets are correctly installed.
- the safety and regulation devices (thermostats) are properly installed inside their housings.
- before reconnecting the equipment to the electrical supply, ensure tank is filled (referring to the appropriate section) and check that there are no water leaks.

5.13 After-sale service

In case of errors or malfunctions, switch off the equipment and disconnect the power supply. Then contact the technical support and the installer in the first instance.

6 MEASURES TO BE ADOPTED IN CASE OF MALFUNCTIONS

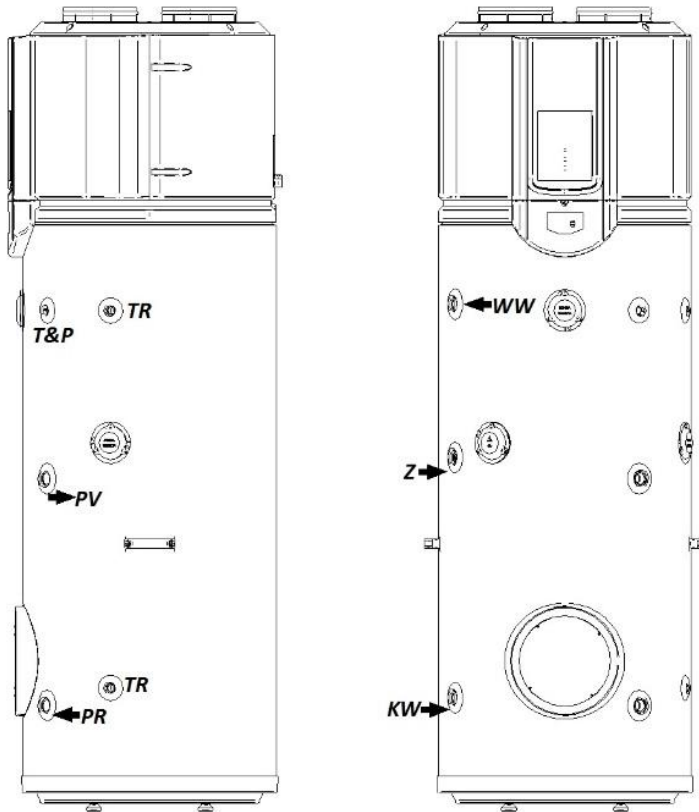
MALFUNCTIONS	POSSIBLE CAUSE	SOLUTION AND EXPLANATIONS
The water is cold, and the display is turned off.	Bad connection to the electrical supply.	Re-connect the supply.
	The water temperature is set too low.	Set the water temperature at a higher value.
	The temperature control is damaged	Call for assistance.
	The temperature sensor is damaged.	
Water does not come out.	The water supply was isolated.	When the water supply will be restored, it will turn to normal.
	The water pressure is too low.	Use the system when the pressure returns to normal.
	The entry water valve is closed.	Open the entry water valve.
Water loss.	The hydraulic connections are not well sealed.	Control and seal all hydraulic connections.
The electrical resistance element makes noises.	Hard water grade is anomalous. Water with lot of limestone.	The limestone deposits on the resistance cause an irregular and violent thermic change in those places where the limestone is scraped. A final solution is to install a water softener.



WARNING: All the operations must be performed with the equipment disconnected from the mains supply.

7 Illustrations

Fig. 1 - Dimension



LEGEND

KW cold water inlet
WW hot water outlet

mod. Ecostore

PV heat exchanger inlet
PR heat exchanger outlet

Z recirculation
K condensate drain pipe

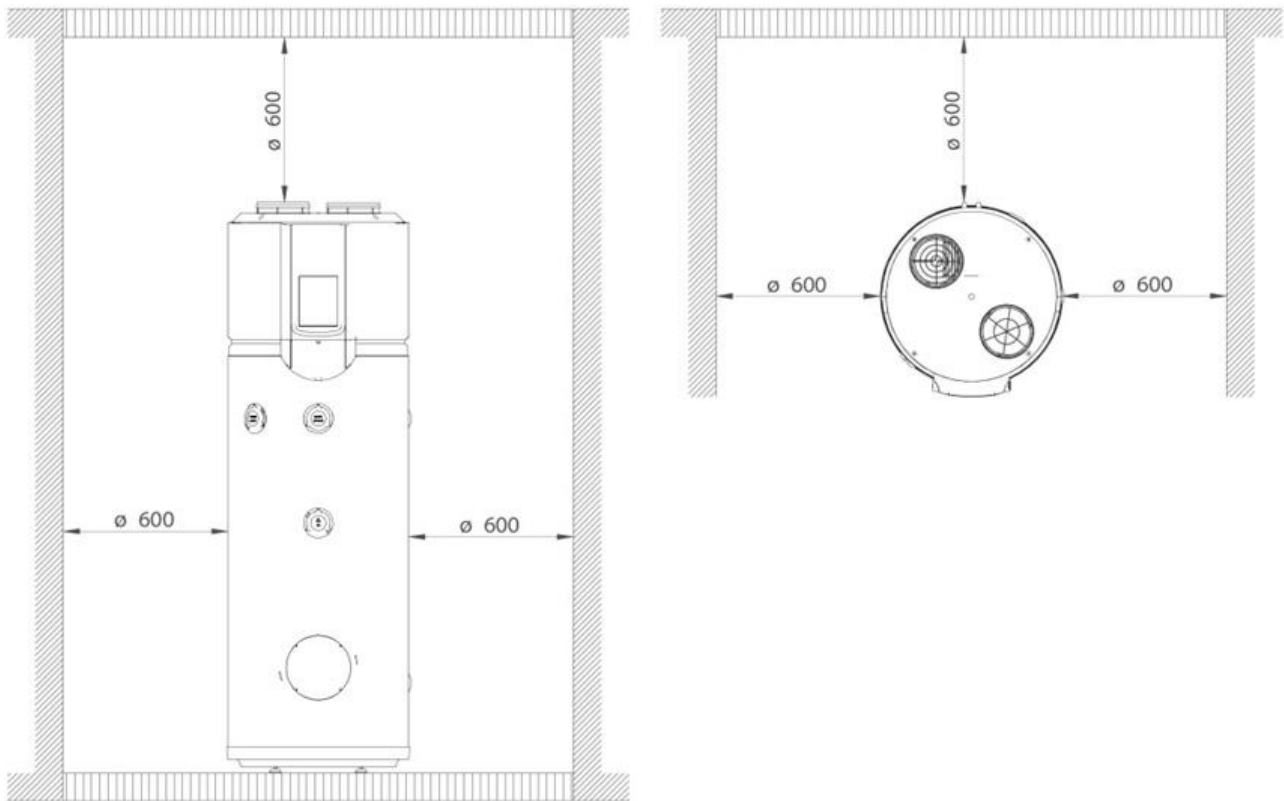
Fig. 2 – Maintenance space requirements (unit: mm)**Recommended**

Fig. 4 - Hydraulic connection diagram – Second Heat Source

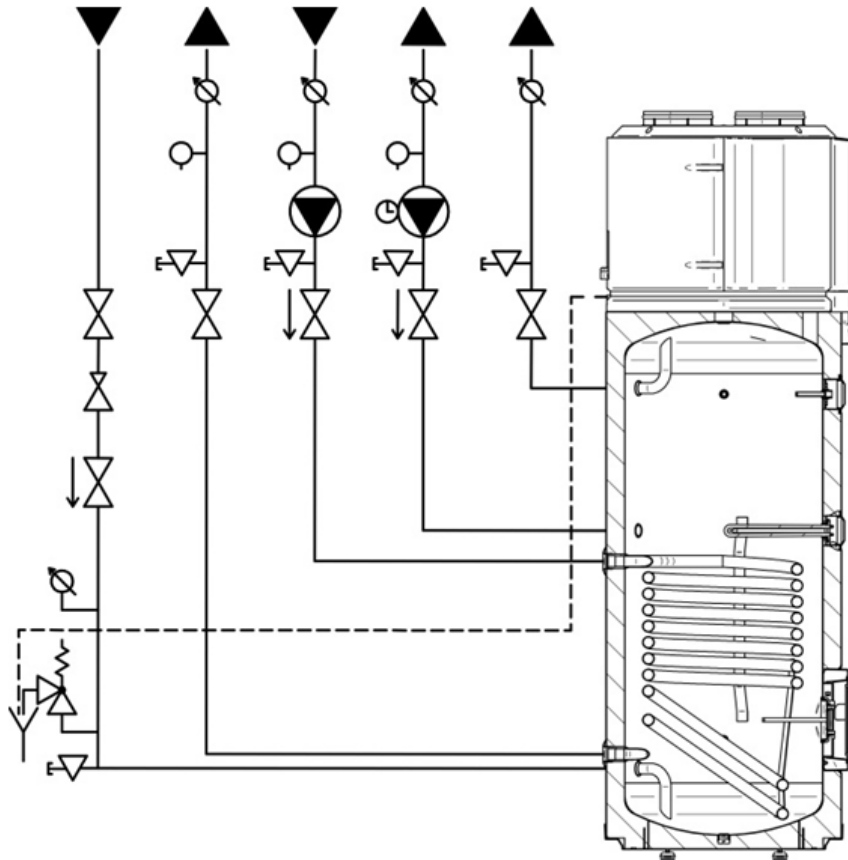
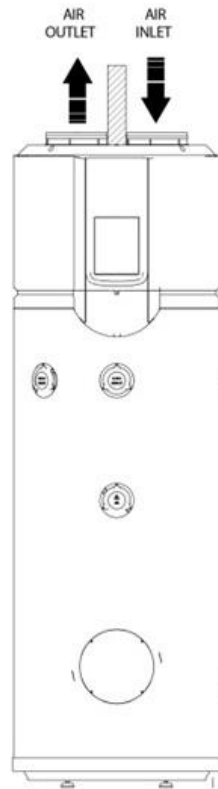


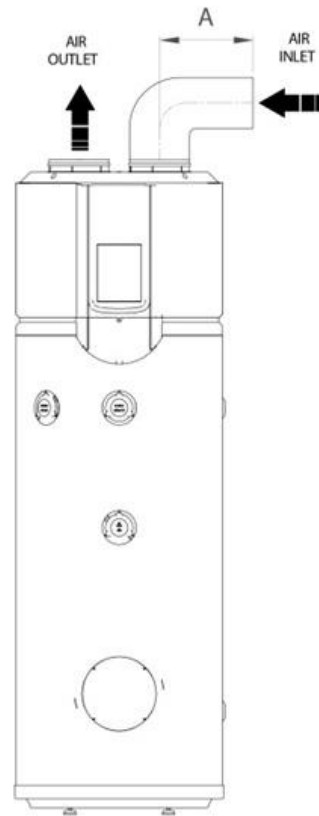
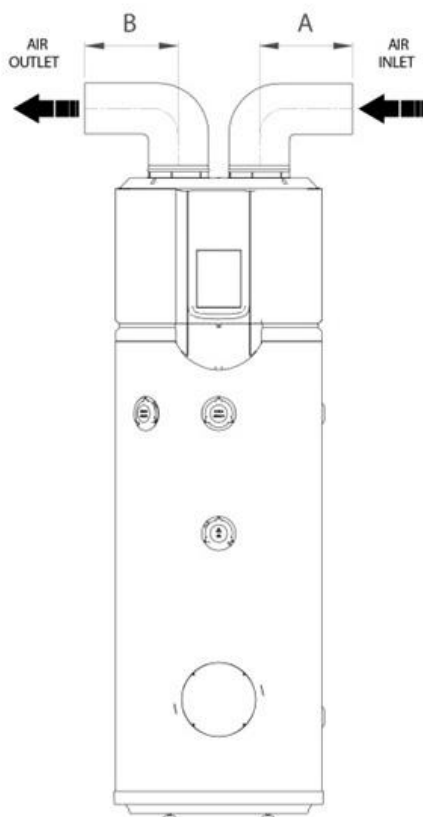
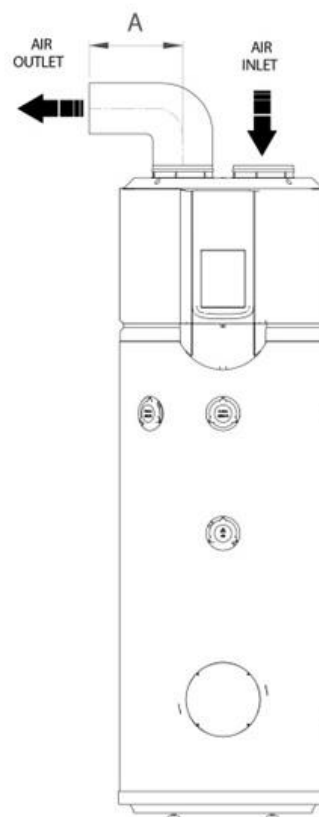
Fig. 4 - Hydraulic connection diagram – Twin Coil Circuits
SYMBOL LEGEND

	Interception valve
	Interception valve with retain device
	Pressure reduction
	Thermometer
	Manometer
	Condensate pipe
	Drain tap
	Safety valve
	Leak valve
	Pump
	Timer

Fig. 6 - Duct



A: Without ducting

B: Air outlet without conveyor, air inlet connect to duct ($A \leq 5m$)C: Air inlet and outlet with duct ($A+B \leq 5m$)D: Air outlet connect to conveyor, air inlet without duct ($A \leq 5m$)



Heat pump for hot water without connection to air ducts

Thanks to the vast range of heat pump for hot sanitary water (without, with one or two exchangers with thermic heat integration), the solar systems and other supply sources, as for example firewood heaters, can represent a further use of the environmental energy.



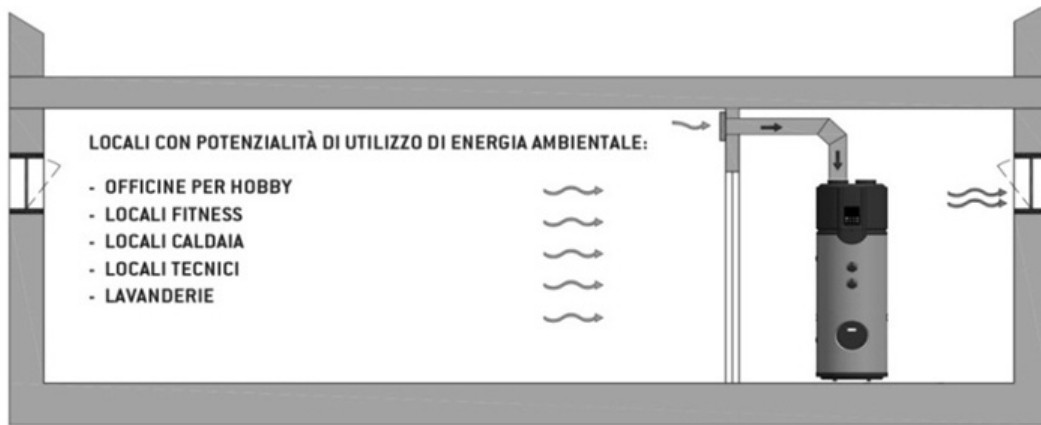
Heat pump for hot water with connection to the air ducts (outlet kit)

Through the heat released from the air, the expelled air is cooled and can be used to refresh one or more rooms through the use of air ducts (for example to refresh a wine cellar, workshops during the summer period, greenhouses, etc.): a double energetic advantage with an optimal energetic efficiency.



Heat pump for hot water with connection to the air ducts (inlet air - outlet air)

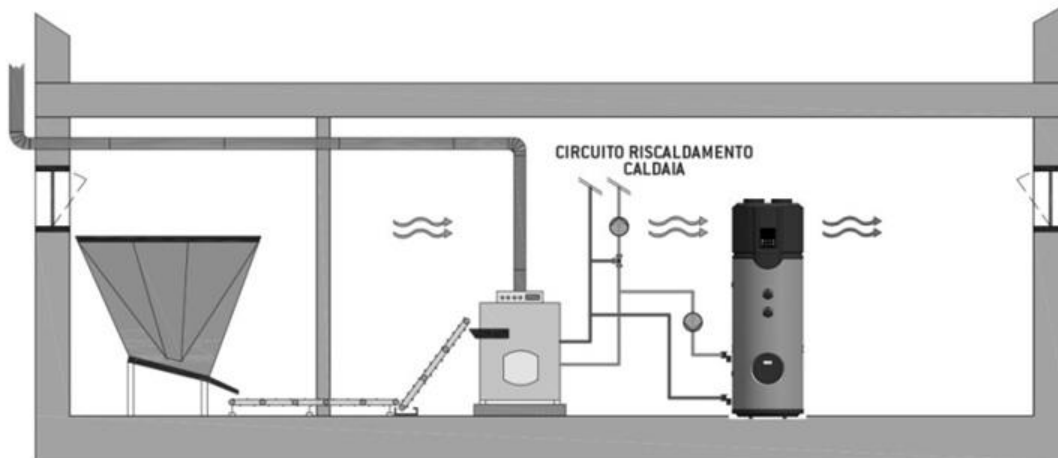
Fig. 7



Heat pump for sanitary hot water with aspiration kit



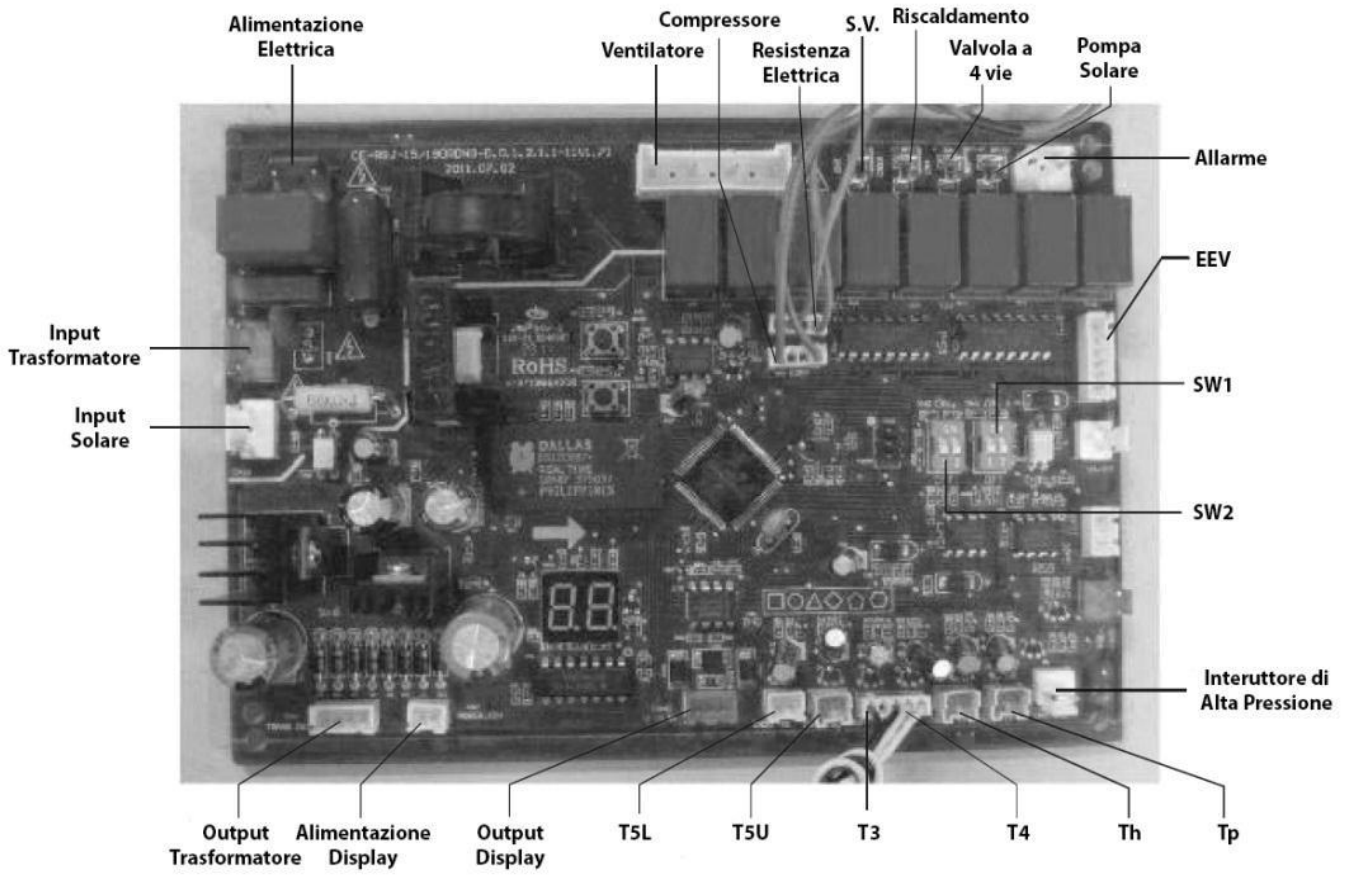
Heat pump for sanitary hot water with aspiration kit



Heat pump for sanitary water with pellet boiler



Heat pump for sanitary water with wall-mounted gas boiler



TEMPERATURE SENSOR
LEGEND

- T3: Evaporator output temperature sensor
- T4: Ambient temperature sensor
- T5U: Upper tank water temperature sensor
- T5L: Lower tank water temperature sensor
- Tp: compressor discharge temperature sensor
- Th: Compressor suction temperature sensor



DISPOSAL OF WASTE ELECTRICAL AND ELECTRONIC EQUIPMENT (2002/96/EC – WEEE DIRECTIVE)

This symbol indicates that the appliance must not be treated as domestic waste upon disposal.

Rather, it must be delivered to an authorized collection center for the recycling of electrical and electronic appliances.

Proper disposal of this appliance will avoid potential health hazards and adverse consequences for the environment.

Recycling of materials helps to preserve natural resources.

For further information about the recycling of this appliance, please contact your municipal offices, your domestic waste disposal service, or the retailer/installer from whom the appliance was purchased.

The penalties for failure to comply with these disposal procedures are laid down in local legislation.



WARNING:

The equipment contains R134a-type refrigerating gas, that must not be released into the atmosphere. Make sure that you only entrust qualified personnel with the operations.

This product complies with the EU 2002/96/EC directive

Compliant with the MD of 04-06-2004 implementing the 98/83 EC European Directive regarding water quality.

MAINS PRESSURE HOT WATER STORAGE SYSTEM COMMISSIONING CHECKLIST

This Commissioning Checklist is to be completed in full by the competent person who commissioned the storage system as a means of demonstrating compliance with the appropriate Building Regulations and then handed to the customer to keep for future reference.

Failure to install and commission this equipment to the manufacturer's instructions may invalidate the warranty but does not affect statutory rights.

Customer name:										Telephone number:														
Address:																								
Cylinder Make and Model																								
Cylinder Serial Number																								
Commissioned by (PRINT NAME):										Registered Operative ID Number														
Company name:										Telephone number:														
Company address:																								
										Commissioning date:														
To be completed by the customer on receipt of a Building Regulations Compliance Certificate*:																								
Building Regulations Notification Number (if applicable)																								
ALL SYSTEMS PRIMARY SETTINGS (indirect heating only)																								
Is the primary circuit a sealed or open vented system?										Sealed					Open									
What is the maximum primary flow temperature?																								
ALL SYSTEMS																								
What is the incoming static cold water pressure at the inlet to the system?																								
Has a strainer been cleaned of installation debris (if fitted)?															Yes					No				
Is the installation in a hard water area (above 200ppm)?															Yes					No				
If yes, has a water scale reducer been fitted?															Yes					No				
What type of scale reducer has been fitted?																								
What is the hot water thermostat set temperature?																								
What is the maximum hot water flow rate at set thermostat temperature (measured at high flow outlet)?																								
Time and temperature controls have been fitted in compliance with Part L of the Building Regulations?															Yes									
Type of control system (if applicable)										Y Plan			S Plan			Other								
Is the cylinder solar (or other renewable) compatible?															Yes					No				
What is the hot water temperature at the nearest outlet?																								
All appropriate pipes have been insulated up to 1 metre or the point where they become concealed															Yes									
UNVENTED SYSTEMS ONLY																								
Where is the pressure reducing valve situated (if fitted)?																								
What is the pressure reducing valve setting?																								
Has a combined temperature and pressure relief valve and expansion valve been fitted and discharge tested?															Yes					No				
The tundish and discharge pipework have been connected and terminated to Part G of the Building Regulations																								
Are all energy sources fitted with a cut out device?															Yes					No				
Has the expansion vessel or internal air space been checked?															Yes					No				
THERMAL STORES ONLY																								
What store temperature is achievable?																								
What is the maximum hot water temperature?																								
ALL INSTALLATIONS																								
The hot water system complies with the appropriate Building Regulations															Yes									
The system has been installed and commissioned in accordance with the manufacturer's instructions															Yes									
The system controls have been demonstrated to and understood by the customer															Yes									
The manufacturer's literature, including Benchmark Checklist and Service Record, has been explained and left with the customer															Yes									
Commissioning Engineer's Signature																								
Customer's Signature																								
(To confirm satisfactory demonstration and receipt of manufacturer's literature)																								

*All installations in England and Wales must be notified to Local Authority Building Control (LABC) either directly or through a Competent Persons Scheme. A Building Regulations Compliance Certificate will then be issued to the customer.



SERVICE RECORD

It is recommended that your heating system is serviced regularly and that the appropriate Service Interval Record is completed.

Service Provider

Before completing the appropriate Service Record below, please ensure you have carried out the service as described in the manufacturer's instructions. Always use the manufacturer's specified spare part when replacing controls.

SERVICE 01		Date:	SERVICE 02		Date:
Engineer name:		Engineer name:		Engineer name:	
Company name:		Company name:		Company name:	
Telephone No:		Telephone No:		Telephone No:	
Operative ID No:		Operative ID No:		Operative ID No:	
Comments:		Comments:		Comments:	
-----		-----		-----	
-----		-----		-----	
-----		-----		-----	
Signature		Signature		Signature	
SERVICE 03		Date:	SERVICE 04		Date:
Engineer name:		Engineer name:		Engineer name:	
Company name:		Company name:		Company name:	
Telephone No:		Telephone No:		Telephone No:	
Operative ID No:		Operative ID No:		Operative ID No:	
Comments:		Comments:		Comments:	
-----		-----		-----	
-----		-----		-----	
-----		-----		-----	
Signature		Signature		Signature	
SERVICE 05		Date:	SERVICE 06		Date:
Engineer name:		Engineer name:		Engineer name:	
Company name:		Company name:		Company name:	
Telephone No:		Telephone No:		Telephone No:	
Operative ID No:		Operative ID No:		Operative ID No:	
Comments:		Comments:		Comments:	
-----		-----		-----	
-----		-----		-----	
-----		-----		-----	
Signature		Signature		Signature	
SERVICE 07		Date:	SERVICE 08		Date:
Engineer name:		Engineer name:		Engineer name:	
Company name:		Company name:		Company name:	
Telephone No:		Telephone No:		Telephone No:	
Operative ID No:		Operative ID No:		Operative ID No:	
Comments:		Comments:		Comments:	
-----		-----		-----	
-----		-----		-----	
-----		-----		-----	
Signature		Signature		Signature	
SERVICE 09		Date:	SERVICE 10		Date:
Engineer name:		Engineer name:		Engineer name:	
Company name:		Company name:		Company name:	
Telephone No:		Telephone No:		Telephone No:	
Operative ID No:		Operative ID No:		Operative ID No:	
Comments:		Comments:		Comments:	
-----		-----		-----	
-----		-----		-----	
-----		-----		-----	
Signature		Signature		Signature	



Cool Energy Holding Ltd.

163 Cleethorpe Road,

Grimsby,

DN31 3AX.

Email: sales@coolenergyshop.com

www.coolenergyshop.com

