

# **User Manual**

## **Energy Storage System**

**Version: 1.2**

# Table of Contents

1.	Introduction .....	1
2.	Important Safety Warning .....	2
3.	Unpacking & Overview .....	4
	3-1. Packing List .....	4
	3-2. Product Overview .....	5
4.	Installation .....	7
	4-1. Selecting Mounting Location .....	7
	4-2. Mounting The System .....	7
5.	Wiring Connection .....	14
	5-1. Grid Connection .....	14
	5-2. PV Module (DC) Connection .....	15
	5-3. Battery Connection .....	18
	5-4. Load (AC Output) Connection .....	21
6.	Communication .....	22
	6-1. Communication Connection .....	22
	6-2. Dry Contact Connection .....	23
7.	Commissioning .....	24
8.	Initial Setup by using monitoring software .....	25
9.	Operation .....	35
	Operation and Display Panel .....	35
	Touchable function key .....	35
	LCD Display Icons .....	36
	LCD Setting .....	39
	Operating Mode Description .....	48
	Select Displays .....	53
10.	Maintenance & Cleaning .....	57
11.	Trouble Shooting .....	58
	11-1. Fault code reference .....	58
	11-2. Warning Reference Codes .....	61
12.	Specifications .....	62
Appendix I: The Wi-Fi Operation Guide .....		63
	1.Introduction .....	63
	2.SolarPower App Installation .....	67
	3. SolarPower APP Operation .....	67
Appendix II: Energy Meter Installation Guide .....		74
	1.Introduction .....	74
	2.Wiring Connection .....	75
	3.Setup .....	75
	4.Troubleshooting.....	76

# 1. Introduction

This energy storage system can provide power to connected loads by utilizing PV power, utility power and battery power and store surplus energy generated from PV solar modules for use when needed. When the sun has set, energy demand is high, or there is a black-out, you can use the energy stored in this system to meet your energy needs at no extra cost. In addition, this energy storage system helps you pursue the goal of energy self-consumption and ultimately energy-independence.

Depending on different power situations, this energy storage system is designed to generate continuous power from PV solar modules (solar panels), battery, and the utility. When MPP input voltage of PV modules is within acceptable range (see specification for the details), this energy storage system is able to generate power to feed the grid (utility) and charge. This energy storage system is only compatible with PV module types of single crystalline and poly crystalline. Do not connect any PV array types other than these two types of PV modules to the energy storage system. Do not connect the positive or negative terminal of the solar panel to the ground. See Figure 1 for a simple diagram of a typical energy storage system.

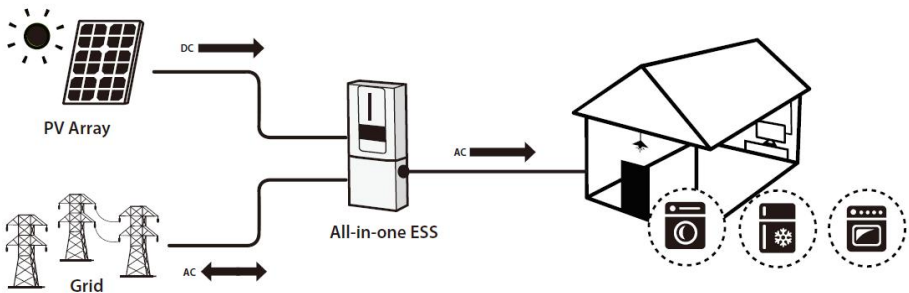

**Figure 1 Energy storage System Overview**

**Note:** To conform to the EEG standard, every energy storage system sold to German area is not allowed to charge from Utility. The relevant function is automatically disabled via the software.

## 2. Important Safety Warning

**Before using the inverter, please read all instructions and cautionary markings on the unit and this manual. Store the manual where it can be accessed easily.**

This manual is for qualified personnel. The tasks described in this manual may be performed by qualified personnel only.

### General Precaution-

#### Conventions used:

**WARNING!** Warnings identify conditions or practices that could result in personal injury;

**CAUTION!** Caution identify conditions or practices that could result in damage to the unit or other equipment connected.



**WARNING!** Before installing and using this inverter, read all instructions and cautionary markings on the inverter and all appropriate sections of this guide.



**WARNING!** Normally grounded conductors may be ungrounded and energized when a ground fault is indicated.



**WARNING!** This inverter is so heavy that it should be lifted by at least two persons.



**CAUTION!** Before attempting any maintenance or cleaning or working on any circuits connected to the inverter, disconnecting AC, DC and battery power from the inverter can reduce the risk of electric shock. Merely turning off controls will not reduce this risk because internal capacitors can remain charged for 5 minutes after disconnecting all sources of power.



**CAUTION!** Do not disassemble this inverter by yourself. It contains no user-serviceable parts. Attempt to service this inverter by yourself may cause electric shock or fire and will void the warranty from the manufacturer.



**CAUTION!** To avoid fire and electric shock, make sure that existing wiring is in good condition and that the wire is not undersized. Do not operate the damaged Inverter or substandard wiring.



**CAUTION!** In high temperature environment, the surface of this inverter could be hot enough to cause skin burns if accidentally touched. Ensure that this inverter is away from normal traffic areas.



**CAUTION!** Use only recommended accessories from installer. Otherwise, disqualified tools may cause fire, electric shock, or injury to persons.



**CAUTION!** To reduce risk of fire hazard, do not cover or obstruct the cooling fan.



**CAUTION!** Do not operate the Inverter if it has undergone a sharp blow, been dropped, or damaged in any way. If the Inverter is damaged, please call for an RMA (Return Material Authorization) request.



**CAUTION!** AC breaker, DC switch and Battery circuit breaker are used as disconnect devices and these disconnect devices shall be easily accessible.

<b>Before working on this circuit</b>	
<ul style="list-style-type: none"> <li>- Isolate inverter/Uninterruptible Power System (UPS)</li> <li>- Then check for Hazardous Voltage between all terminals including the protective earth.</li> </ul>	
	<b>Risk of Voltage Backfeed</b>

**Symbols used in Equipment Markings**

	Refer to the operating instructions
	Caution! Risk of danger
	Caution! Risk of electric shock
	Caution! Risk of electric shock. Energy storage timed discharge for 5 minutes.
	Caution! Hot surface











### 3. Unpacking & Overview

#### 3-1. Packing List

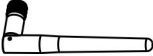
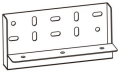



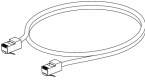



Before installation, please inspect the unit. Be sure that nothing inside the package is damaged. To guarantee goods in good condition during transportation, we offer separate packages for inverter and battery unit.

#### Inverter Package

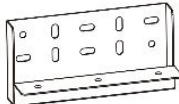
You should receive the following items inside of package:

			
Inverter module	PV connector x 2	Mounting screws x 4	Manual
			
WiFi antenna	Mounting brackets	Flat-head screws x 3	Software CD
			
Nylon-Plug x 4	Energy meter	RJ45 cable	Bracket cover

#### Battery Module Package

			
Battery module	Battery cable #B-B	Top-bracket	bottom plate
			
L-shape plate x 2	M3 Flat-head screws*8	M4 Flat-head screws*15	Exploding screw*6
			
RJ11 cable			

#### Base

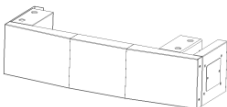

## 3-2. Product Overview

### Inverter Module

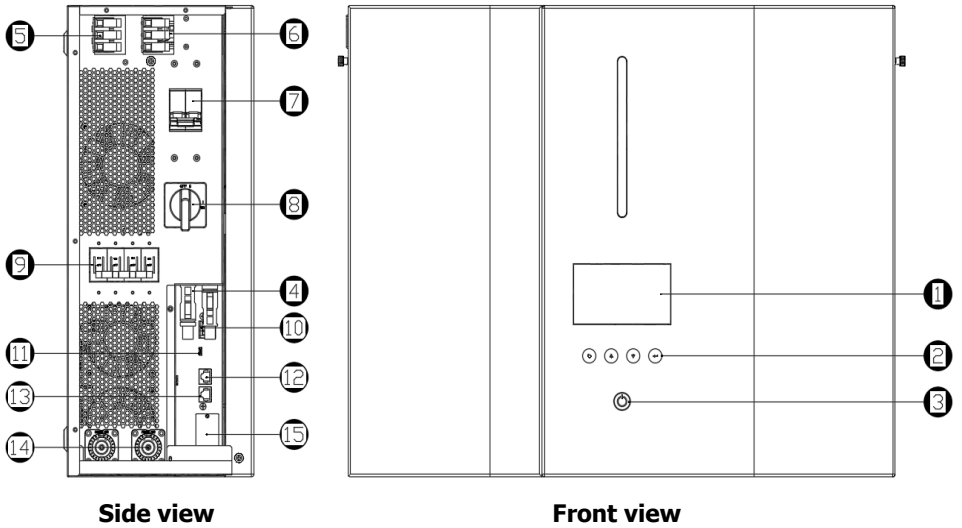

1. LCD display
2. Touchable function buttons
3. Power on/off button
4. PV connectors
5. AC output
6. AC input
7. AC breaker
8. PV breaker
9. DC breaker
10. Dry contact
11. USB port
12. RS-232 port
13. BMS com. port
14. Battery connectors
15. Intelligent slot

## Battery Module

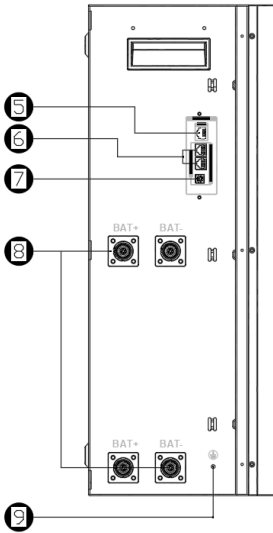

**Side view**

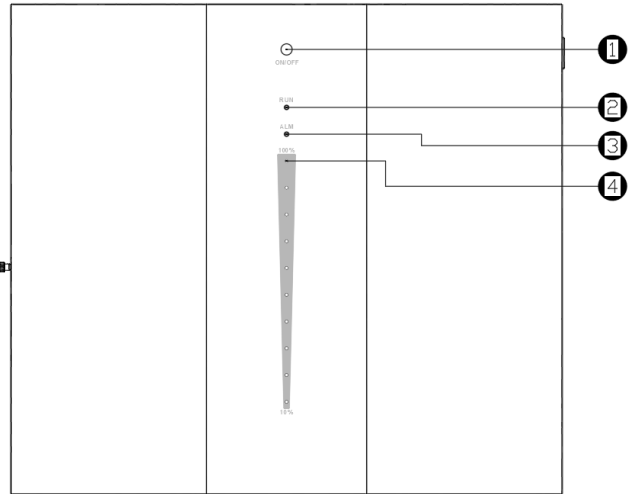

**Front view**

1. Power on/off button
2. Run
3. Alm
4. Battery capacity indicators
5. Extension port
6. Extension port
7. ID switch
8. Battery connectors
9. ground



## 4. Installation

### 4-1. Selecting Mounting Location

Consider the following points to install the energy storage system:

- Do not mount the inverter on flammable construction materials.
- Mount on a solid surface
- This energy storage system might make noises during operation which may be perceived as a nuisance in a living area.
- Install this inverter module at eye level in order to allow the readability of LCD display at all times.
- For proper air circulation to dissipate heat and further maintenance, allow a clearance of approx. 50 cm to the sides of the unit.
- Dusty conditions on the unit may impair the performance of this inverter.
- The ambient temperature should be between 0°C and 40°C and relative humidity should be between 5% and 85% to ensure optimal operation.
- The recommended installation is vertical adherence.
- For proper operation of this energy storage system, please use appropriate cables for grid connection.
- The pollution degree of the energy storage system is PD2. Select an appropriate mounting location. Install the inverter and battery modules in a protected area that is dry, free of excessive dust and with adequate air flow. Do NOT operate it in the place where the temperature and humidity is beyond the specific limits. (Please check the specs for the limitations.)
- The inverter should be installed in the position where the disconnection means is easily accessible.
- This inverter is designed with IP20 protection for indoor applications only.
- Regularly clean the fan filter.

### 4-2. Mounting The System

**WARNING!!** Remember that this inverter is heavy so please be careful when removing it from the package.

Installation to the wall should be fixed with proper screws. After that, the device should be bolted on securely.

The energy storage system can only operate in a CLOSED ELECTRICAL OPERATING AREA. Only service personnel can enter this area.

**WARNING!!** FIRE HAZARD.  
SUITABLE FOR MOUNTING ON CONCRETE OR OTHER NON-COMBUSTIBLE SURFACE ONLY.

This energy storage system should be installed battery modules first on the bottom and then inverter module on the top.

**Step 1:** Use  $\varnothing 10\text{mm}$  drill to drill holes at a depth about 50mm, The holes pitch are as follows: (Install the nylon-plug after drilling is completed)

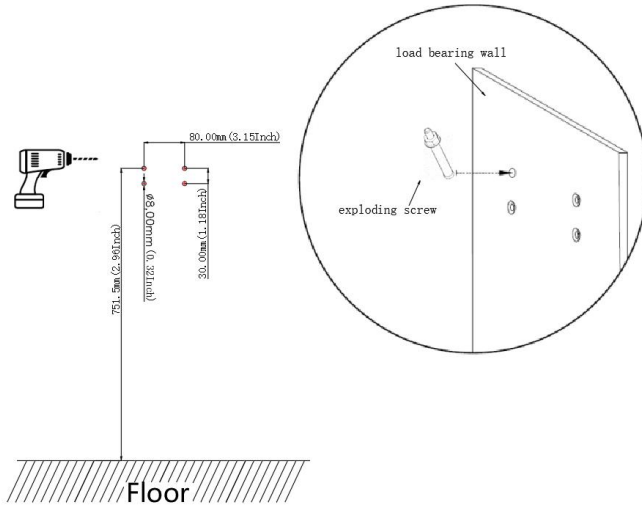

**Step 2:** Remove side cover of battery module first.

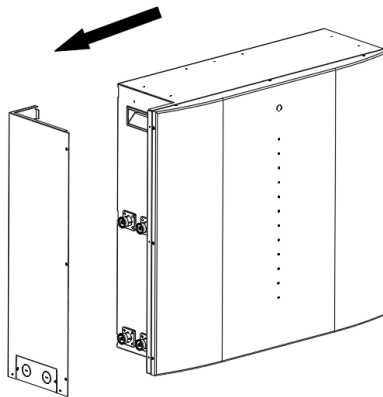

**Step 3:** Lay the battery pack flat, connect the base to the battery pack with 4 screws.

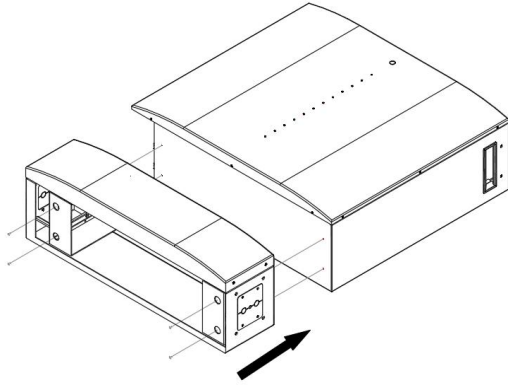

**Step 4:** Fix Top-bracket of the battery module separately with three flat-head screws as shown in the chart.

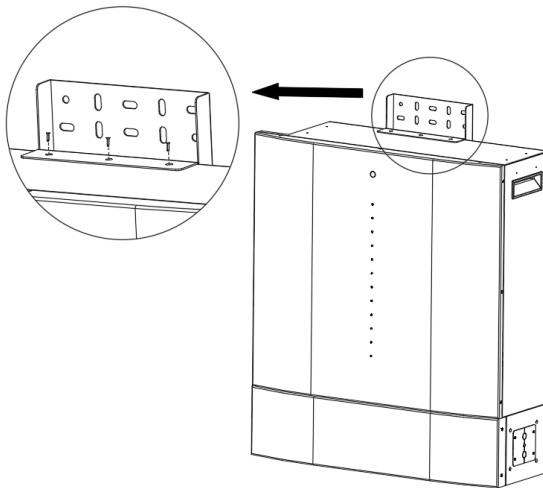

**Step 5:** Mounting the Top-bracket with four screws on the wall.

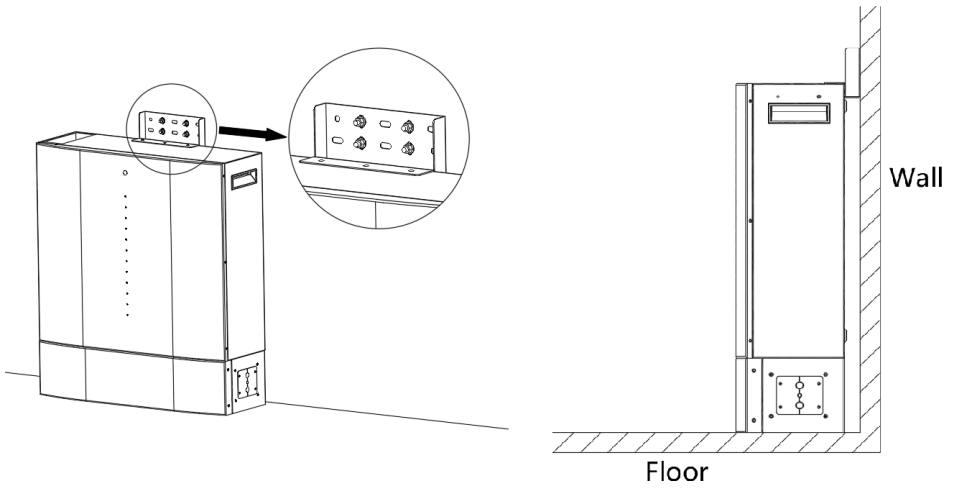

**Step 6:** Drill holes with a  $\varnothing 8\text{mm}$  drill bit, the depth is about 60mm, and the hole spacing is as follows: (install the explosion screws after drilling)

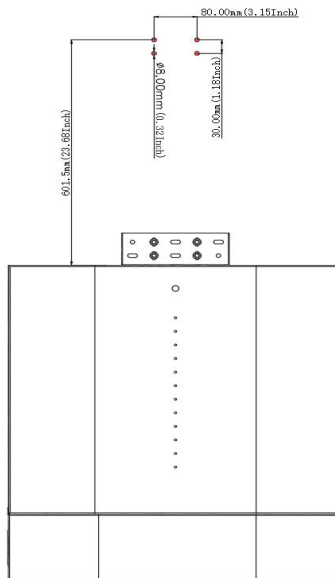

**Step 7:** Fix two L-shape plates on the bottom of the second battery module with four flat-head screws.

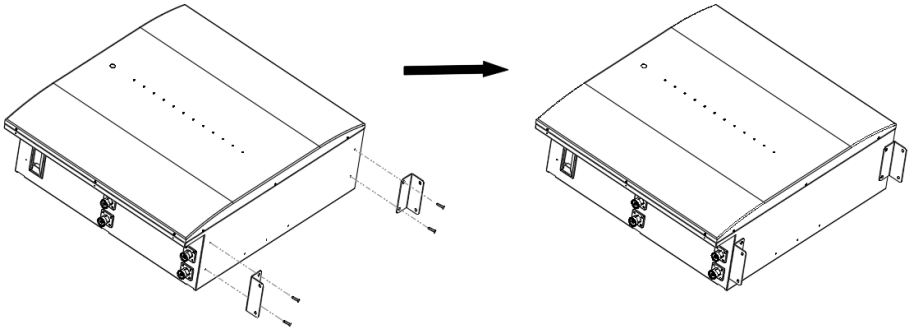

**Step 8:** Put the second battery module on the top of first battery module and fix two L-shape plates to the first battery module with four round-head screws. Then, fix the second battery module to the wall with four mounting screws.

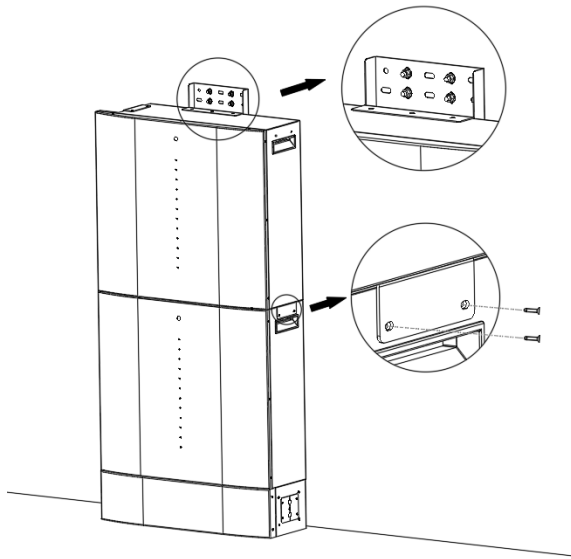

**Step 9:** Use  $\varnothing 8\text{mm}$  to drill holes at a depth about 50mm at the wall and insert nylon - plug inside of each holes.

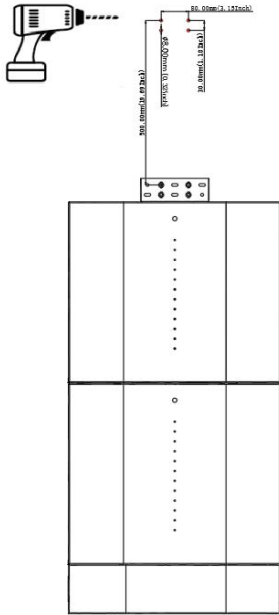

**Step 10:** Fix two L-shape plates on the bottom of the inverter module with four flat-head screws and also fix bracket on the top of the inverter with two flat-head screws.

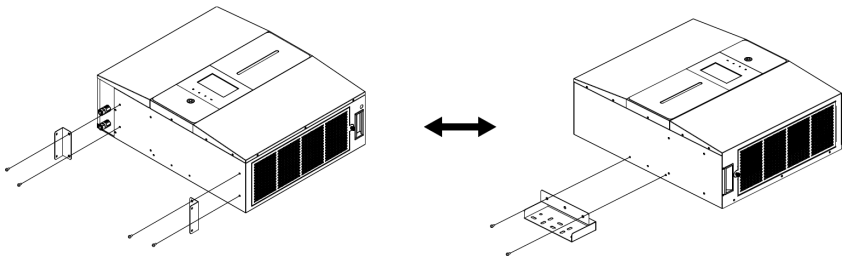

**Step 11:** Put the inverter module on the top of second battery module. Fix mounting bracket with four mounting screws to the wall. Then, fix two L-shape plates to the second battery module with four round-head screws.

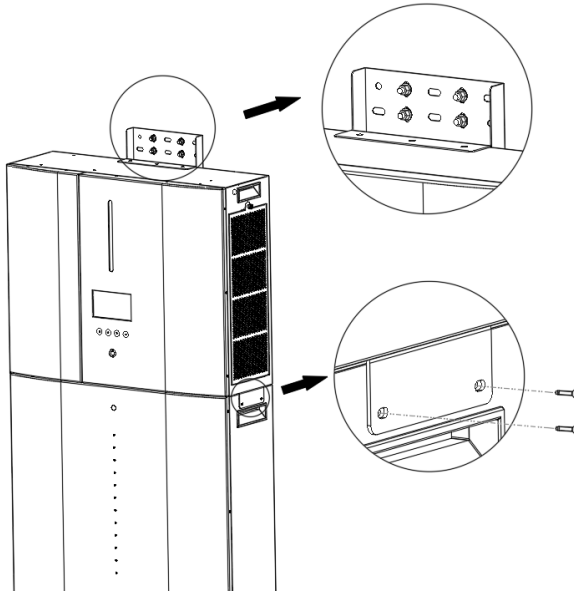

**Step 12:** Fix bracket cover to the mounting bracket with flat-head screws.



## 5. Wiring Connection

Before connecting all wires, be sure that side covers of inverter and battery modules are removed. This step should be executed before modules are installed to the wall.

### 5-1. Grid Connection

#### 5-1-1. Preparation

Before connecting to AC utility, please install a **separate** AC circuit breaker between surge protection device (SPD) and AC utility. This will ensure the inverter can be securely disconnected during maintenance and fully protected from over current of AC input.

**NOTE:** The overvoltage category of the AC input is III. It should be connected to the power distribution.

**WARNING!** For safety and efficiency, it's very important to use appropriate cables for grid (utility) connection. To reduce risk of injury, please use the proper cable size recommended below.

Suggested cable requirement for AC wire

Model	ESS
Nominal Grid Voltage	230VAC
Conductor cross-section (mm <sup>2</sup> )	6
AWG no.	10

#### 5-1-2. Connecting to the AC Utility

**Step 1:** Check the grid voltage and frequency with an AC voltmeter to see if it's same as the "VAC" value on the product label.

**Step 2:** Turn off the circuit breaker.

**Step 3:** Remove insulation sleeve 10 mm from three conductors and shorten phase L and neutral conductor N for 3 mm. Refer to chart 1.

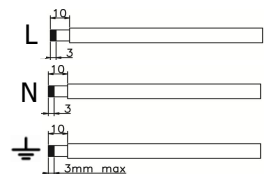

Chart 1

**Step 4:** Connect wires according to the polarities indicating on terminal block. Be sure to connect PE protective conductor (**G**) first.

**L**→LINE (brown or black)

**N**→Neutral (blue or white)

**G**→Ground (yellow-green)

**Step 5:** Make sure the wires are securely connected. The reference tightening torque is 1.4~1.6N.m.

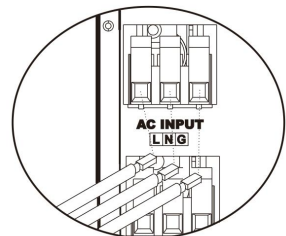

Chart 2



## 5-2. PV Module (DC) Connection

**CAUTION:** Before connecting to PV modules, please install **separately** DC circuit breakers between inverter and PV modules.

**NOTE1:** Please use 600VDC/30A circuit breaker.

**NOTE2:** The overvoltage category of the PV input is II.

Please follow the steps below to implement PV module connection:

**WARNING:** Because this inverter is non-isolated, only three types of PV modules are acceptable: single crystalline and poly crystalline with class A-rated and CIGS modules.

To avoid any malfunction, do not connect any PV modules with possible current leakage to the inverter. For example, grounded PV modules will cause current leakage to the inverter. When using CIGS modules, please be sure NO grounding.

**CAUTION:** It's requested to use PV junction box with surge protection. Otherwise, it will cause damage on inverter when lightning occurs on PV modules.

**Step 1:** Check the input voltage of PV array modules. The acceptable input voltage of the inverter is 250VDC-450VDC (with rated load). This system is applied with two strings of PV array. Please make sure that the maximum current load of each PV input connector is 13A.

**CAUTION:** Exceeding the maximum input voltage can destroy the unit!! Check the system before wire connection.

**Step 2:** Disconnect the circuit breaker and switch off the DC switch.

**Step 3:** Assemble provided PV connectors with PV modules by the following steps.

### Components for PV connectors and Tools:

Female connector housing	
Female terminal	
Male connector housing	
Male terminal	
Crimping tool and spanner	

### Prepare the cable and follow the connector assembly process:

Strip one cable 8 mm on both end sides and be careful NOT to nick conductors.

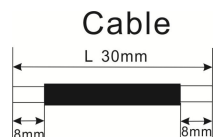

Insert striped cable into female terminal and crimp female terminal as shown below.



Insert assembled cable into female connector housing as shown below.

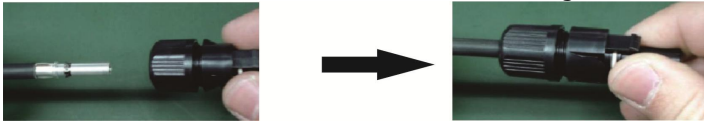

Insert striped cable into male terminal and crimp male terminal as shown below.



Insert assembled cable into male connector housing as shown below.

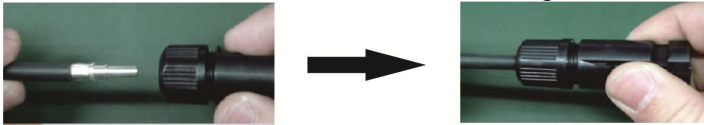

Then, use spanner to screw pressure dome tightly to female connector and male connector as shown below.



**Step 4:** Check the correctness of the polarity of connection cable on PV modules and PV input connectors. Then, connect positive pole (+) of connection cable to positive pole (+) of PV input connector. Connect negative pole (-) of connection cable to negative pole (-) of PV input connector.

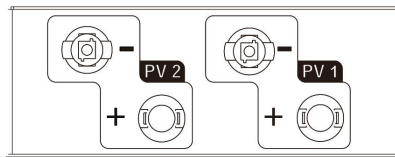
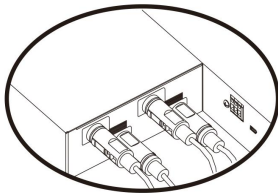

**WARNING!** For safety and efficiency, it's very important to use appropriate cables for PV module connection. To reduce risk of injury, please use the proper cable size as recommended below.

Conductor cross-section (mm <sup>2</sup> )	AWG no.
4~6	10~12

**CAUTION: Never** directly touch the terminals of inverter. It might cause lethal electric shock.

## Recommended Panel Configuration

**CAUTION:** Do NOT touch the inverter to avoid electric shock. When PV modules are exposed to sunlight, it may generate DC voltage in the inverter.

<b>Solar Panel Spec. (reference)</b>	<b>SOLAR INPUT 1</b>	<b>SOLAR INPUT 2</b>	<b>Q'ty of panels</b>	<b>Total Input Power</b>
	<b>(Min in serial: 6pcs; Max. in serial: 12pcs)</b>			
- 260Wp	6pcs in serial	x	6pcs	1560W
- Vmp: 30.7Vdc	x	6pcs in serial	6pcs	1560W
- Imp: 9.18A	8pcs in serial	x	8pcs	2080W
- Voc: 38.9Vdc	x	8pcs in serial	8pcs	2080W
- Isc: 8.56A	6pcs in serial	6pcs in serial	12pcs	3120W
- Cells: 60	7pcs in serial	7pcs in serial	14pcs	3640W
	8pcs in serial	8pcs in serial	16pcs	4160W
	10pcs in serial	10pcs in serial	20pcs	5200W
	12pcs in serial	12pcs in serial	24pcs	6240W

<b>Solar Panel Spec. (reference)</b>	<b>SOLAR INPUT 1</b>	<b>SOLAR INPUT 2</b>	<b>Q'ty of panels</b>	<b>Total Input Power</b>
	<b>(Min in serial: 4pcs; Max. in serial: 7pcs)</b>			
- 500Wp	4pcs in serial	x	4pcs	2000W
- Vmp: 42.8Vdc	x	4pcs in serial	4pcs	2000W
- Imp: 11.69A	6pcs in serial	x	6pcs	3000W
- Voc: 51.7Vdc	x	6pcs in serial	6pcs	3000W
- Isc: 12.28A	7pcs in serial	x	7pcs	3500W
- Cells: 150	x	7pcs in serial	7pcs	3500W
	4pcs in serial	4pcs in serial	8pcs	4000W
	5pcs in serial	5pcs in serial	10pcs	5000W
	6pcs in serial	6pcs in serial	12pcs	6000W

### 5-3. Battery Connection

**CAUTION:** Before connecting to battery modules, please **disconnect** the DC breaker between inverter and batteries.

#### Single battery connection

**Step 1:** Use supplied two battery cables #B-B (supplied in battery module package). Follow the polarity of battery printed near the battery terminal! Simply plug battery cable to battery terminals on inverter module and battery module as shown in the chart.

**ORANGE cable to the positive terminal (+)**

**BLACK cable to the negative terminal (-)**

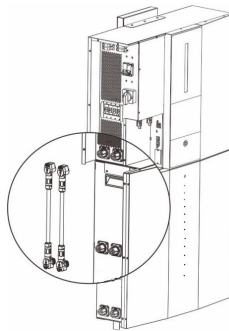

**WARNING!** Wrong connections may damage the unit permanently.

**Step 2:** Make sure the wires are securely connected.

**Step 3:** Insert the supplied RJ45 cable (from inverter module package) into the BMS port on the inverter module. The other end connects to RS485 port on the first battery module.

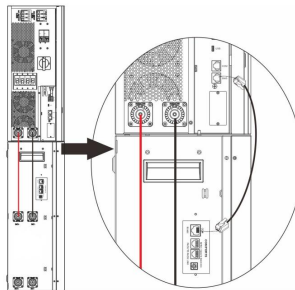

**Step 4:** Insert the supplied RJ11 signal cable (from battery module package) into one of the extension port ( or ) on the battery module.

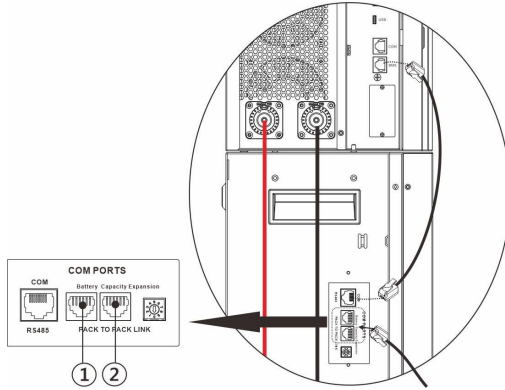

**Multiple battery connection**

If there are more battery modules to connect, use supplied battery cable #B-B (inside of battery module package) to connect the first battery module and second battery module as shown below chart. Follow the polarity of battery printed near the battery terminal!

**ORANGE cable to the positive terminal (+)**

**BLACK cable to the negative terminal (-)**

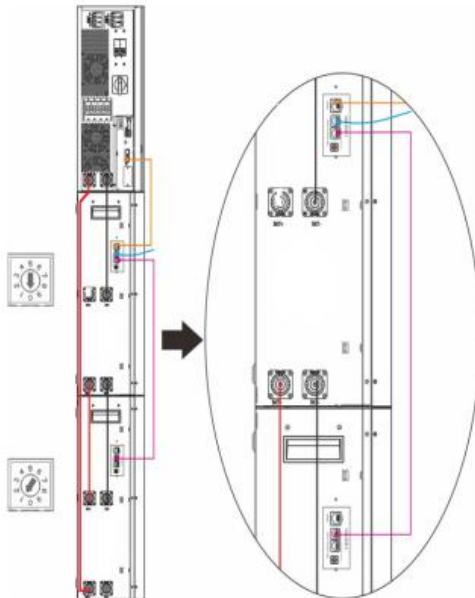

**Step 2:** Insert the supplied RJ11 cable (from battery module package) into the extension port on the first battery module. The other end connects to extension port on the second battery module.

**Step 3:** After all wiring installation is complete, set up ID for each battery module. The ID code for each battery module **MUST** be unique. Not the same number for 2 battery modules in parallel system. Refer below chart for the details.

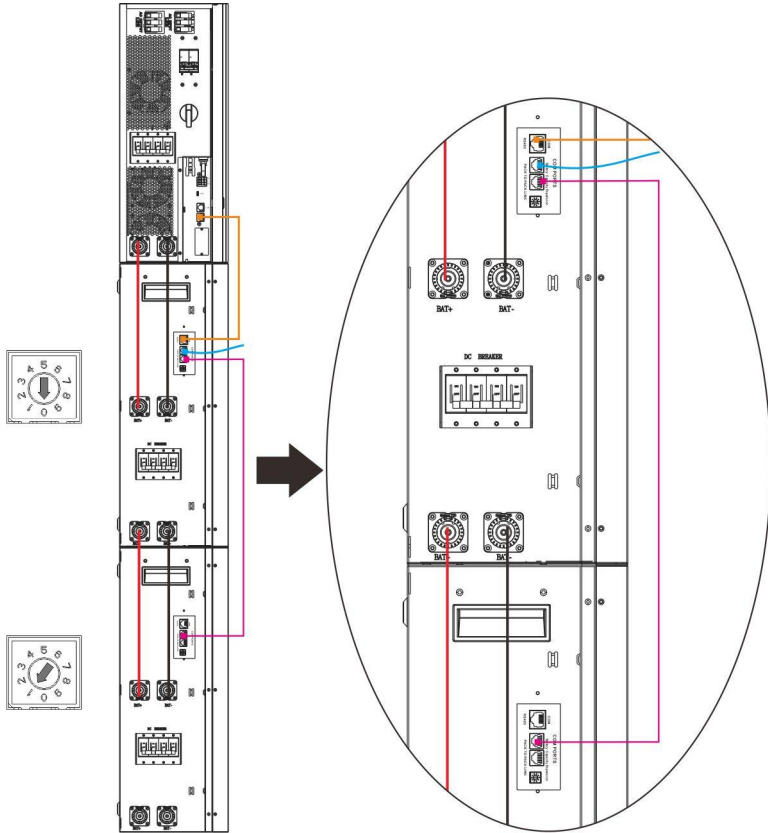

## 5-4. Load (AC Output) Connection

**CAUTION:** To prevent extra supply to the load via the inverter during any mode of operation, an additional disconnection device should be placed on the building wiring installation.

**WARNING!** For safety and efficiency, it's very important to use appropriate cable for AC connection. To reduce risk of injury, please use the proper cable size recommended as below.

Model	ESS
Nominal Grid Voltage	230VAC
Conductor cross-section (mm <sup>2</sup> )	6
AWG no.	10

**Step 1:** Remove insulation sleeve 8 mm for three conductors. And shorten phase L and neutral conductor N 3 mm. Refer to Diagram 3.

**Step 2:** Connect wires according to the polarities indicated on terminal block. Be sure to connect PE protective conductor (≡) first. Refer to Diagram 4.

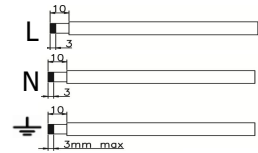

Diagram 3

**L**→**LINE (brown or black)**

≡→**Ground (yellow-green)**

**N**→**Neutral (blue or white)**

**Step 3:** Make sure the wires are securely connected. The reference tightening torque is 1.4~1.6N.m.

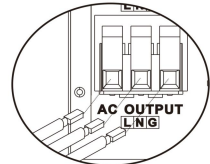

Diagram 4

**CAUTION:** It's only allowed to connect load to "AC Output Connector". Do NOT connect the utility to "AC Output Connector".

**CAUTION:** Be sure to connect L terminal of load to L terminal of "AC Output Connector" and N terminal of load to N terminal of "AC Output Connector". The G terminal of "AC Output Connector" is connected to grounding of the load. Do NOT misconnect.

**CAUTION:** This inverter is not allowed to operate in parallel. Please do NOT connect more than one unit in parallel in AC output connector. Otherwise, it will damage this

## 6. Communication

### 6-1. Communication Connection

The inverter is equipped with USB and RS-232 ports and a slot for alternative communication interfaces in order to communicate with a PC via corresponding software. This intelligent slot is install with Modbus card use to communicate with external Energy meter. Follow the procedure below to connect communication wiring and install the software.

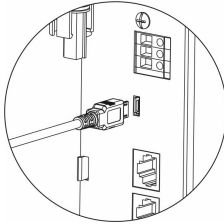
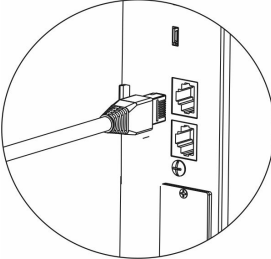
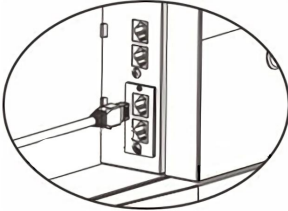
<p>For USB port, you should use a USB cable as follows:</p>	<p>For RS232 port, you should use a RS-232 cable as follows:</p>	<p>For connecting with external energy meter, please use RJ45 cables and refer to Appendix II</p>
		

Please install monitoring software in your computer. Detailed information is listed in next chapter. After software is installed, you may initialize the monitoring software and extract data through communication port.

This unit also equipped with a Wi-Fi transmitter. Wi-Fi transmitter can enable wireless communication between inverter and monitoring platform. Before operating wireless communication, please install WiFi antenna on the unit as shown in the below chart.

Users can access and control the monitored inverter with downloaded APP. You may find "SolarPower" app from the Apple® Store or "SolarPower Wi-Fi" in Google® Play Store. All data loggers and parameters are saved in iCloud. Before using Wi-Fi transmitter, please connect the external antenna on the side of inverter. For quick installation and operation, please refer to Appendix I - The Wi-Fi Operation Guide for details.

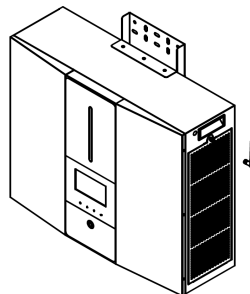
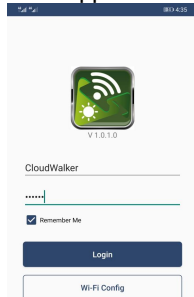



## 6-2. Dry Contact Connection

There is one dry contact available. It could be used to remote control for external generator. For Dry contact port, please remove insulation sleeve 8 mm for three conductors and insert three cables into ports.

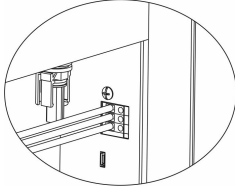

### Electric Parameter

Parameter	Symbol	Max.	Unit
Relay DC voltage	Vdc	30	V
Relay DC current	Idc	1	A

Note: The application of the dry contact should not exceed the electric parameter shown as above. Otherwise, the internal relay will be damaged.

### Function Description

Unit Status	Condition	Dry contact	
		NO&C	NC&C
Power Off	Unit is off and no output is powered.	Open	Close
Power On	Battery voltage is lower than setting battery cut-off discharging voltage when grid is available.	Close	Open
	Battery voltage is lower than setting battery cut-off discharging voltage when grid is unavailable.	Close	Open
	Battery voltage is higher than below 2 setting values: 1. Battery re-discharging voltage when grid is available. 2. Battery re-discharging voltage when grid unavailable.	Open	Close

You can set the related parameters in the morning software. Refer to below chart:

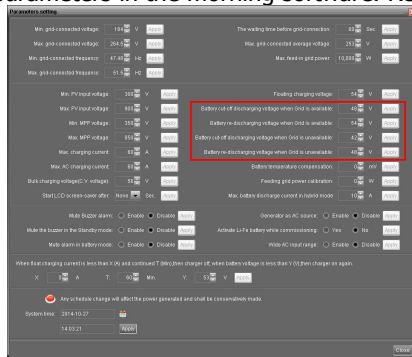

## 7. Commissioning

**Step 1:** Check the following requirements before commissioning:

- Ensure the inverter is firmly secured
- Check if the open circuit DC voltage of PV module meets the requirement (Refer to Section 5.2)
- Check if the voltage of the open circuit utility is approximately as same as the expected nominal value from local utility company.
- Check if connection of AC cable to grid (utility) is correct if the utility is required.
- Fully connect to PV modules.

**Step 2:** Switch on the DC breaker and breakers of each battery module. Then, switch on PV breaker. After that, if there is any connection with utility, please switch on the AC breaker. At this moment, the energy storage system is already turned on. However, there is no output generated to loads. Then:

- If LCD lights up to display the status of the unit, commissioning has been completed successfully. After pressing "ON" button for 1 second when the utility is detected, this inverter will start to supply power to the loads. If no utility exists, simply press "Power on/off" button for 3 seconds. Then, this unit will start to supply power to the loads.
- If an error occurs to this inverter, a warning/fault indicator will appear on LCD display. Please inform your installer.

## 8. Initial Setup by using monitoring software

Before inverter starts to operate, it's required to set up "Operation Mode" via software. Please strictly follow the steps below to set up. For more details, please refer to software manual.

**Step 1:** After turning on the inverter and installing the software, please click "Open Monitor" to enter main screen of this software.

**Step 2:** Log in the software first by entering the default password "administrator."

**Step 3:** Select Device Control>>MyPower Management to set up inverter operation mode and personalized interface. Refer to diagram below.

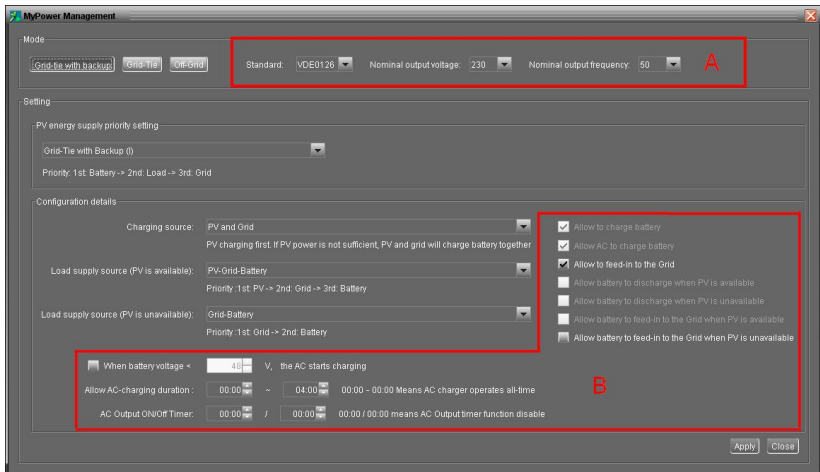
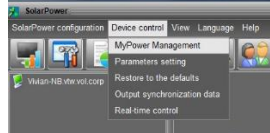

### Mode

There are three operation modes: Grid-tie with backup, Grid-Tie and Off-Grid.

- Grid-tie with backup: PV power can feed back to grid, provide power to the load and charge battery. There are four options available in this mode: Grid-tie with backup I, II, III and IV. In this mode, users can configure PV power supply priority, charging source priority and load supply source priority. However, when Grid-tie with backup IV option is selected in PV energy supply priority, the inverter is only operating between two working logics based on defined peak time and off-peak time of electricity. Only peak time and off-peak time of electricity are able to set up to optimize electricity usage.
- Grid-Tie: PV power can only feed back to grid.
- Off-Grid: PV power can only provide power to the load and charge battery but can't feed back to grid.

## SECTION A:

Standard: It will list local grid standard. To make any modification, you're requested to have factory password. Please check local dealer only when this standard change is requested.

**CAUTION:** Wrong setting could cause damage to the unit or not working.

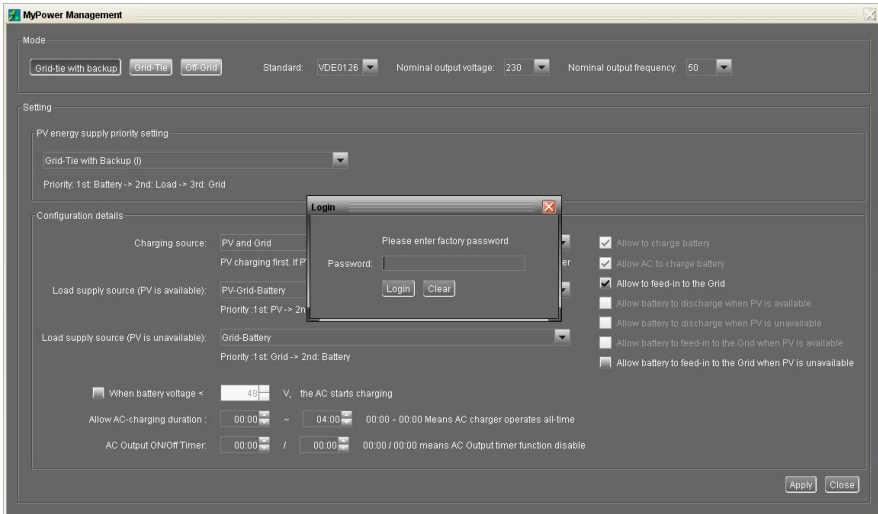

Nominal Output Voltage: 230V.

Nominal Output Frequency: 50HZ.

## SECTION B:

This section contents may be different based on different selection of operations.

**Allow AC charging duration:** It's a period of time to allow AC (grid) to charge battery. When the duration is set as 0:00-00:00, it means no time limitation for AC to charge battery.

**AC output ON/Off Timer:** Set up on/off time for AC output of inverter. If setting it as 00:00/00:00, this function is disabled.

**Allow to charge battery:** This option is automatically determined by setting in "Charging source". It's not allowed to modify here. When "NONE" is selected in charging source section, this option becomes unchecked in grey text.

**Allow AC to charge battery:** This option is automatically determined by setting in "Charging source". It's not allowed to modify here. When "Grid and PV" or "Grid or PV" is selected in charging source section, this option is default selected. In Grid-tie mode, this option is invalid.

**Allow to feed-in to the Grid:** This option is only valid under Grid-tie and Grid-tie with backup modes. Users can decide if this inverter can feed-in to the grid.

Allow battery to discharge when PV is available: This option is automatically determined by setting in "Load supply source (PV is available)". When "Battery" is higher in priority than "Grid" in Load supply source (PV is available), this option is selected in default. Under Grid-tie, this option is invalid.

Allow battery to discharge when PV is unavailable: This option is automatically determined by setting in "Load supply source (PV is unavailable)". When "Battery" is higher in priority than "Grid" in Load supply source (PV is unavailable), this option is selected in default. In Grid-tie mode, this option is invalid.

Allow battery to feed-in to the Grid when PV is available: This option is only valid in Grid-tie with backup II or Grid-tie with backup III modes.

Allow battery to feed-in to the Grid when PV is unavailable: This option is only valid in all options of Grid-tie with backup mode.

## Grid-tie with backup

### Grid-tie with backup (I):

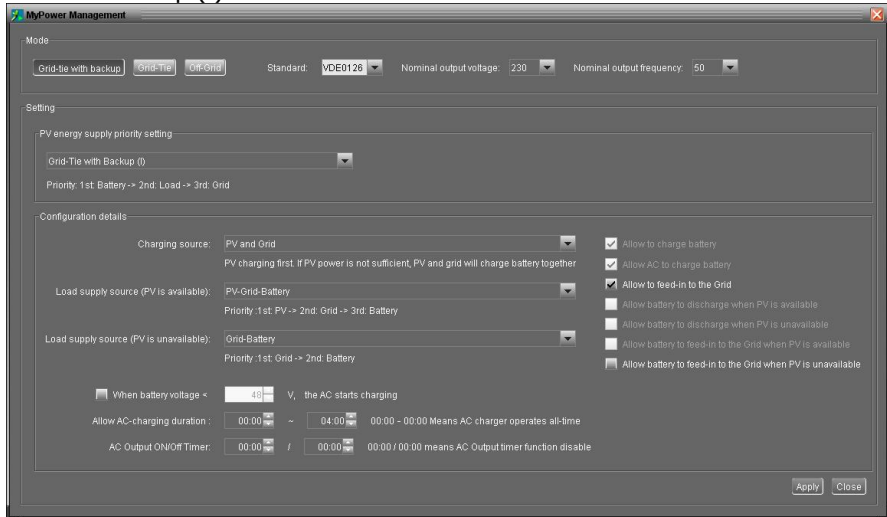

**PV energy supply priority setting: 1<sup>st</sup> Battery, 2<sup>nd</sup> Load and 3<sup>rd</sup> Grid.**

PV power will charge battery first, then provide power to the load. If there is any remaining power left, it will feed-in to the grid.

**Battery charging source:**

1. PV and Grid (Default)

It's allowed to charge battery from PV power first. If it's not sufficient, grid will charge battery.

2. PV only

It is only allow PV power to charge battery.

3. None

It is not allowed to charge battery no matter it's from PV power or grid.

## Load supply source:

When PV power is available: 1<sup>st</sup> PV, 2<sup>nd</sup> Grid, 3<sup>rd</sup> Battery

If battery is not fully charged, PV power will charge battery first. And remaining PV power will provide power to the load. If it's not sufficient, grid will provide power to the load. If grid is not available at the same time, battery power will back up.

When PV power is not available:

1. 1<sup>st</sup> Grid, 2<sup>nd</sup> Battery (Default)

Grid will provide power to the load first. If grid is not available, battery power will provide power backup.

2. 1<sup>st</sup> Battery, 2<sup>nd</sup> Grid

Battery power will provide power to the load first. If battery power is running out, grid will back up the load.

**NOTE:** This option will become ineffective during AC charging time and the priority will automatically become 1st Grid and 2nd Battery order. Otherwise, it will cause battery damage.

## Grid-tie with backup (II):

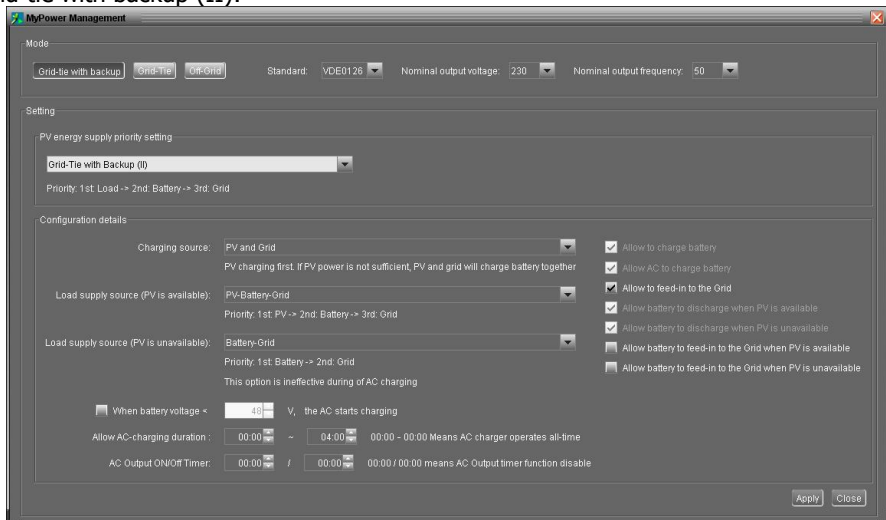

PV energy supply priority setting: 1<sup>st</sup> Load, 2<sup>nd</sup> Battery and 3<sup>rd</sup> Grid.

PV power will provide power to the load first. Then, it will charge battery. If there is any remaining power left, it will feed-in to the grid.

## Battery charging source:

1. PV and Grid

It's allowed to charge battery from PV power first. If it's not sufficient, grid will charge battery.

2. PV only

Only PV power is allowed to charge battery.

### 3. None

It is not allowed to charge battery no matter it's PV power or grid.

#### Load supply source:

When PV power is available:

#### 1. 1<sup>st</sup> PV, 2<sup>nd</sup> Battery, 3<sup>rd</sup> Grid

PV power will provide power to the load first. If it's not sufficient, battery will provide power to the load. When battery is running out power or not available, grid will back up the load.

#### 2. 1<sup>st</sup> PV, 2<sup>nd</sup> Grid, 3<sup>rd</sup> Battery

PV power will provide power to the load first. If it's not sufficient, grid will provide power to the load. If grid is not available at the same time, battery power will back up the load.

When PV power is not available:

1. 1<sup>st</sup> Grid, 2<sup>nd</sup> Battery: Grid will provide power to the load first. If grid is not available, battery will provide power backup.

2. 1<sup>st</sup> Battery, 2<sup>nd</sup> Grid: Battery will provide power to the load first. If battery is running out power, grid will back up the load.

**NOTE:** This option will become ineffective during AC charging time and the priority will automatically become 1<sup>st</sup> Grid and 2<sup>nd</sup> Battery order. Same as Grid-tie with backup (I).

#### Grid-tie with backup (III):

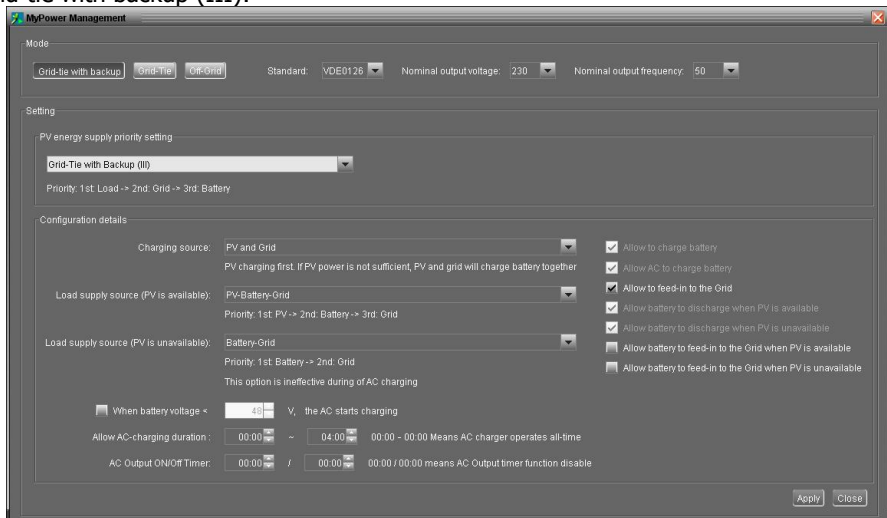

#### PV energy supply priority setting: 1<sup>st</sup> Load, 2<sup>nd</sup> Grid and 3<sup>rd</sup> Battery

PV power will provide power to the load first. If there is more PV power available, it will feed-in to the grid. If feed-in power reaches the max. feed-in power setting, the remaining power will charge battery.

**NOTE:** The max. feed-in grid power setting is available in parameter setting. Please refer to software manual.

### Battery charging source:

1. PV and Grid: It's allowed to charge battery from PV power first. If it's not sufficient, grid will charge battery.
2. PV only: PV power is only allowed to charge battery.
3. None: It is not allowed to charge battery no matter it's PV power or grid.

### Load supply source:

When PV power is available:

1. 1<sup>st</sup> PV, 2<sup>nd</sup> Battery, 3<sup>rd</sup> Grid

PV power will provide power to the load first. If it's not sufficient, battery power will provide power to the load. When battery power is running out or not available, grid will back up the load.

2. 1<sup>st</sup> PV, 2<sup>nd</sup> Grid, 3<sup>rd</sup> Battery

PV power will provide power to the load first. If it's not sufficient, grid will provide power to the load. If grid is not available at the same time, battery power will back up the load.

When PV power is not available:

1. 1<sup>st</sup> Grid, 2<sup>nd</sup> Battery: Grid will provide power to the load first. If grid is not available, battery power will provide power backup.
2. 1<sup>st</sup> Battery, 2<sup>nd</sup> Grid: Battery power will provide power to the load first. If battery power is running out, grid will back up the load.

**NOTE:** This option will become ineffective during AC charging time and the priority will automatically become 1<sup>st</sup> Grid and 2<sup>nd</sup> Battery order. Same as Grid-tie with backup (I).

### Grid-tie with backup (IV):

Users are only allowed to set up peak time and off-peak electricity demand.

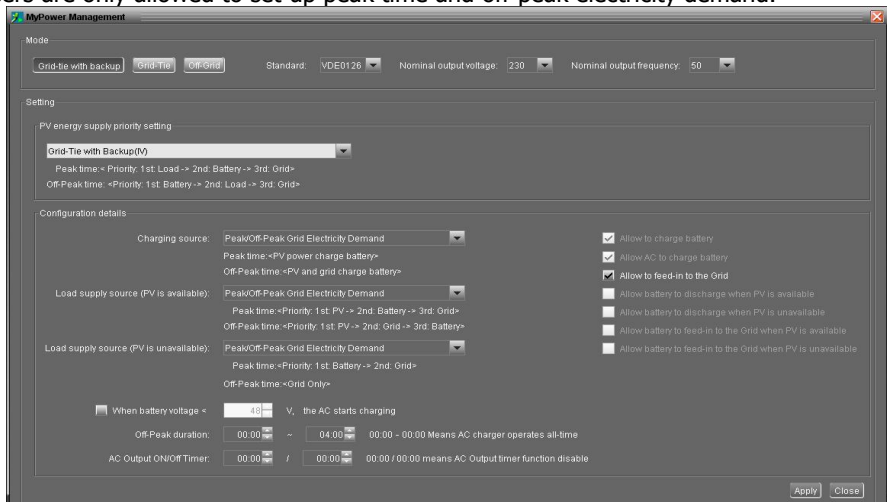

### Working logic under peak time:

PV energy supply priority: 1<sup>st</sup> Load, 2<sup>nd</sup> Battery and 3<sup>rd</sup> Grid

PV power will provide power to the load first. If PV power is sufficient, it will charge



battery next. If there is remaining PV power left, it will feed-in to the grid. Feed-in to the grid is disabled in default.

**Battery charging source:** PV only

Only after PV power fully supports the load, the remaining PV power is allowed to charge battery during peak time.

**Load supply source:** 1<sup>st</sup> PV, 2<sup>nd</sup> Battery, 3<sup>rd</sup> Grid

PV power will provide power to the load first. If PV power is not sufficient, battery power will back up the load. If battery power is not available, grid will provide the load. When PV power is not available, battery power will supply the load first. If battery power is running out, grid will back up the load.

### Working logic under off-peak time:

**PV energy supply priority:** 1<sup>st</sup> Battery, 2<sup>nd</sup> Load and 3<sup>rd</sup> Grid

PV power will charge battery first. If PV power is sufficient, it will provide power to the loads. The remaining PV power will feed to the grid.

**NOTE:** The max. feed-in grid power setting is available in parameter setting. Please refer to software manual.

**Battery charging source:** PV and grid charge battery

PV power will charge battery first during off-peak time. If it's not sufficient, grid will charge battery.

**Load supply source:** 1<sup>st</sup> PV, 2<sup>nd</sup> Grid, 3<sup>rd</sup> Battery

When battery is fully charged, remaining PV power will provide power to the load first. If PV power is not sufficient, grid will back up the load. If grid power is not available, battery power will provide power to the load.

### Grid-Tie

In this operation mode, PV power only feeds in to the grid. No priority setting is available.

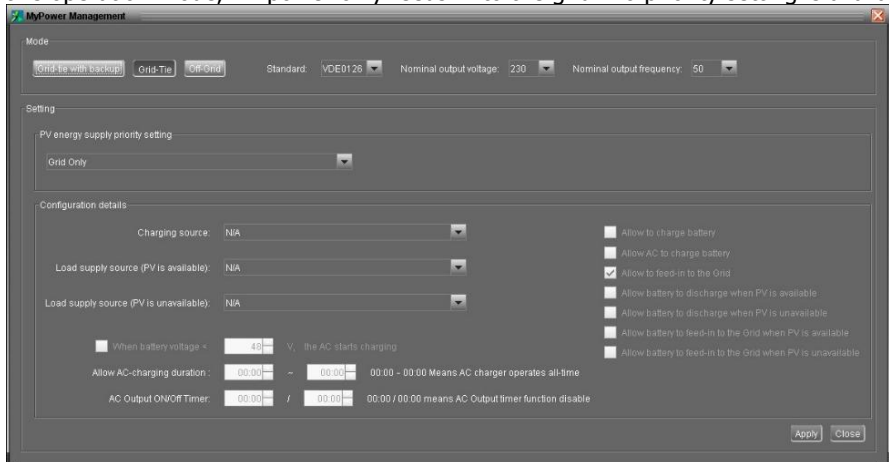

## Off-Grid

- Off-Grid (I): Default setting for off-grid mode.

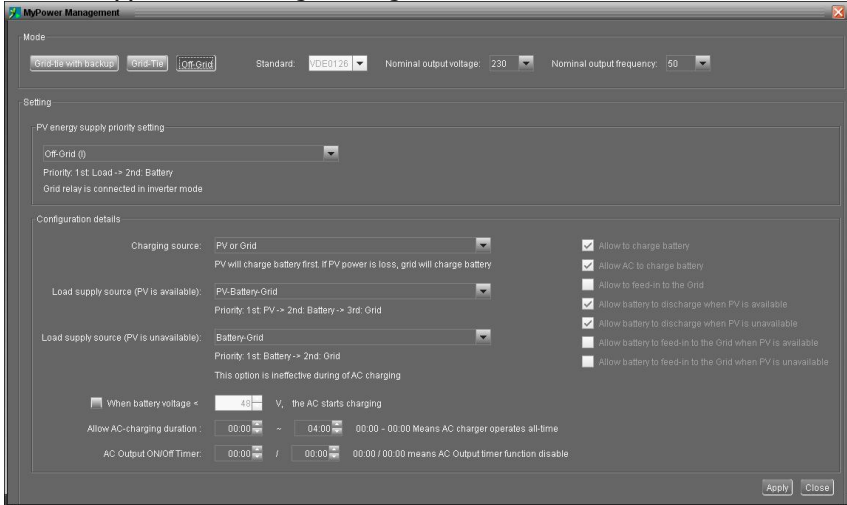

### PV energy supply priority setting: 1<sup>st</sup> Load, 2<sup>nd</sup> Battery

PV power will provide power to the load first and then charge battery. Feed-in to the grid is not allowed in this mode. At the same time, the grid relay is connected in Inverter mode. That means the transfer time from inverter mode to battery mode will be less than 15ms. Besides, it will avoid overload fault because grid can supply load when connected load is over 5KW.

### Battery charging source:

1. PV or Grid: If there is remaining PV power after supporting the loads, it will charge battery first. Only until PV power is not available, grid will charge battery. (Default)
2. PV only: It is only allow PV power to charge battery.
3. None: It is not allowed to charge battery no matter it's PV power or grid.

### Load supply source:

When PV power is available:

1. 1<sup>st</sup> PV, 2<sup>nd</sup> Battery, 3<sup>rd</sup> Grid (Default)

PV power will provide power to the load first. If it's not sufficient, battery power will provide power to the load. When battery power is running out or not available, grid will back up the load.

2. 1<sup>st</sup> PV, 2<sup>nd</sup> Grid, 3<sup>rd</sup> Battery

PV power will provide power to the load first. If it's not sufficient, grid will provide power to the load. If grid is not available at the same time, battery power will back up.

When PV power is not available:

1. 1<sup>st</sup> Grid, 2<sup>nd</sup> Battery

Grid will provide power to the load first. If grid is not available, battery power will provide power backup.

## 2. 1<sup>st</sup> Battery, 2<sup>nd</sup> Grid (Default)

Battery power will provide power to the load first. If battery power is running out, grid will back up the load.

**NOTE:** This option will become ineffective during AC charging time and the priority will automatically become 1<sup>st</sup> Grid and 2<sup>nd</sup> Battery order. Otherwise, it will cause battery damage.

### ● Off-Grid (II)

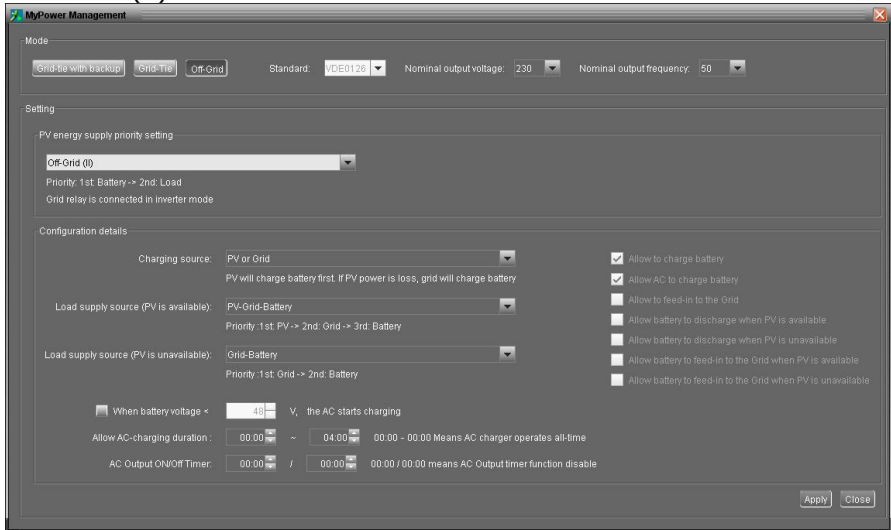

### PV energy supply priority setting: 1<sup>st</sup> Battery, 2<sup>nd</sup> Load

PV power will charge battery first. After battery is fully charged, if there is remaining PV power left, it will provide power to the load. Feed-in to the grid is not allowed under this mode. At the same time, the grid relay is connected in Inverter mode. That means the transfer time from inverter mode to battery mode will be less than 15ms. Besides, it will avoid overload fault because grid can supply load when connected load is over 5KW.

### Battery charging source:

1. PV or Grid: If there is remaining PV power after supporting the loads, it will charge battery first. Only until PV power is not available, grid will charge battery.
2. PV only: It is only allow PV power to charge battery.
3. None: It is not allowed to charge battery no matter it's PV power or grid.

**NOTE:** It's allowed to set up AC charging duration.

### Load supply source:

When PV power is available: 1<sup>st</sup> PV, 2<sup>nd</sup> Grid, 3<sup>rd</sup> Battery

PV power will provide power to the load first. If it's not sufficient, grid will provide power to the load. If grid is not available at the same time, battery power will back up the load.

When PV power is not available:

1. 1<sup>st</sup> Grid, 2<sup>nd</sup> Battery: Grid will provide power to the load first. If grid is not available, battery power will provide power backup.

2. 1<sup>st</sup> Battery, 2<sup>nd</sup> Grid: Battery power will provide power to the load first. If battery power is running out, grid will back up the load.

**NOTE:** This option will become ineffective during AC charging time and the priority will automatically become 1<sup>st</sup> Grid and 2<sup>nd</sup> Battery order. Otherwise, it will cause battery damage.

● Off-Grid (III)

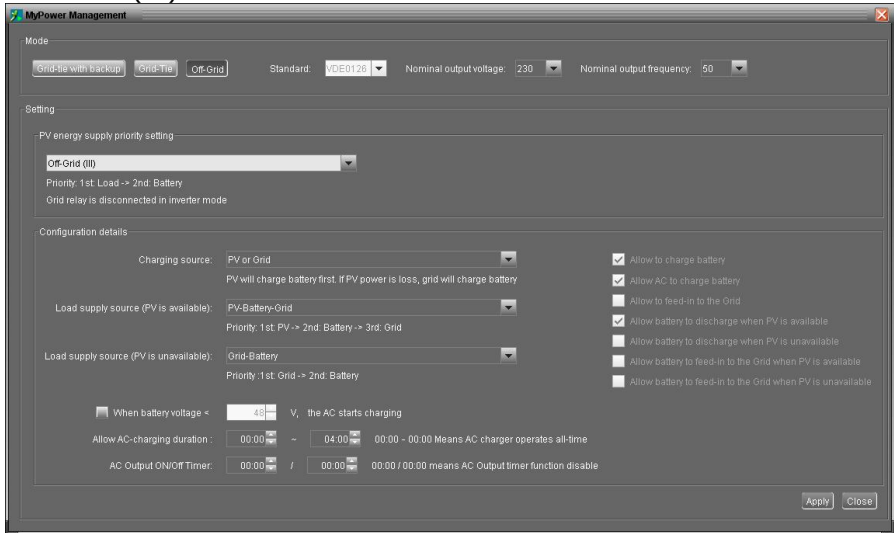

**PV energy supply priority setting: 1<sup>st</sup> Load, 2<sup>nd</sup> Battery**

PV power will provide power to load first and then charge battery. Feed-in to the grid is not allowed in this mode. The grid relay is NOT connected in Inverter mode. That means the transfer time from inverter mode to battery mode will be about 15ms. If connected load is over 5KW and grid is available, this inverter will allow grid to provide power to the loads and PV power to charge battery. Otherwise, this inverter will activate fault protection.

**Battery charging source:**

1. PV or Grid: If there is remaining PV power after supporting the loads, it will charge battery first. Only until PV power is not available, grid will charge battery.
2. PV only: PV power is only allowed to charge battery.
3. None: It is not allowed to charge battery no matter it's PV power or grid.

**NOTE:** It's allowed to set up AC charging duration.

**Load supply source:**

When PV power is available: 1<sup>st</sup> PV, 2<sup>nd</sup> Battery, 3<sup>rd</sup> Grid

PV power will provide power to the load first. If it's not sufficient, battery power will back up the load. Only after battery power is running out, Grid will back up the load.

When PV power is not available:

1. 1<sup>st</sup> Grid, 2<sup>nd</sup> Battery: Grid will provide power to the load first. If grid is not available,

battery power will provide power backup.

2. 1<sup>st</sup> Battery, 2<sup>nd</sup> Grid: Battery power will provide power to the load first. If battery power is running out, grid will back up the load.

**NOTE:** This option will become ineffective during AC charging time and the priority will automatically become 1<sup>st</sup> Grid and 2<sup>nd</sup> Battery order. Otherwise, it will cause battery damage.



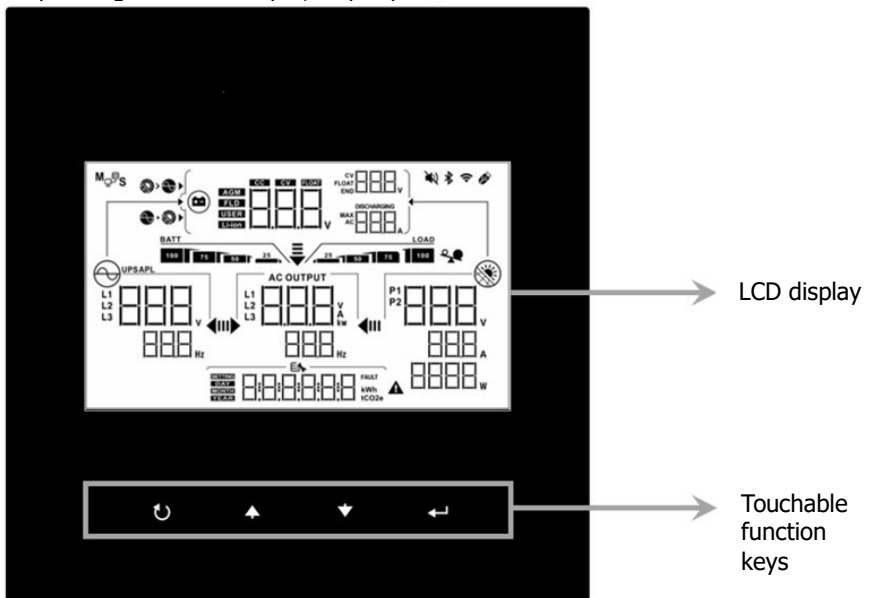

## 9. Operation

### Operation and Display Panel

The operation and display panel, shown in the diagram below, is on the front panel of the inverter. It includes three indicators, four touch key pads and a LCD display, indicating the operating status and input/output power information.







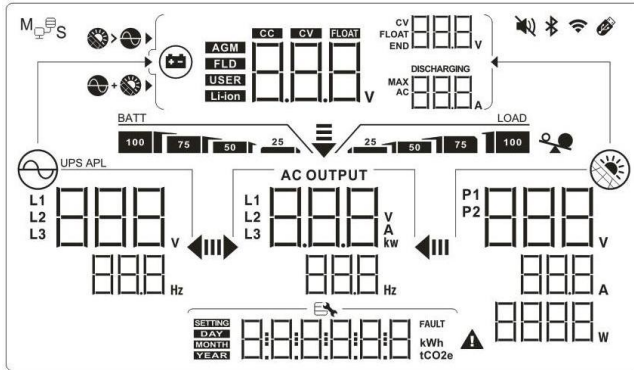

### Touchable function key



Function keys		Description
	ESC	Exit the setting
	Up	To last selection
	Down	To next selection
	Enter	To confirm/enter the selection in setting mode

## LCD Display Icons

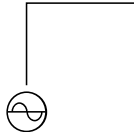
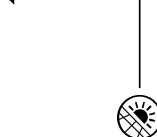

Icon	Function description
<b>Input Source Information</b>	
	Indicates the AC input voltage and frequency.
	Indicates the PV voltage, current and power.
	Indicates the battery voltage, charging stage, configured battery parameters, charging or discharging current.
<b>Configuration Program and Fault Information</b>	
	Indicates the setting programs.
	Indicates the warning and fault codes. Warning: flashing with warning symbol. Fault: lighting with fault character.
<b>Output Information</b>	
	Indicates the output voltage, load in VA, load in Watt and output frequency.
<b>Battery Information</b>	
	Indicates battery level by 0-24%, 25-49%, 50-74% and 75-100% in battery mode and charging status in line mode.
<b>Load Information</b>	

	Indicates overload.
	Indicates the load level by 0-24%, 25-49%, 50-74% and 75-100%.
<b>Charger Source Priority Setting Display</b>	
	Indicates setting program 02 "Charger source priority" is selected as "Solar and Utility".
	Indicates setting program 02 "Charger source priority" is selected as "Solar only".
	If program 02 "Charger source priority" is selected as "Charger disabled". There will be no icon display
<b>Output source priority setting display</b>	
	Indicates setting program 03 "Output source priority" is selected as "SUB".
	Indicates setting program 03 "Output source priority" is selected as "SBU".
<b>AC Input Voltage Range Setting Display</b>	
UPS	Indicates setting program 2B is selected as "G C d". The acceptable AC input voltage range will be within 184-264.5VAC (depend on setting program 11, default is VDE4105).
APL	Indicates setting program 2B is selected as "G C E". The acceptable AC input voltage range will be within 170-280VAC.
<b>Operation Status Information</b>	
	Indicates unit connects to the mains.
	Indicates unit connects to the PV panel.



<p><b>AGM</b></p> <p><b>FLD</b></p> <p><b>USER</b></p> <p><b>Li-ion</b></p>	<p>Indicates battery type.</p>
<p>M<sub>CS</sub></p>	<p>Indicates parallel operation is working.</p>
	<p>Indicates unit alarm is disabled.</p>
	<p>Indicates Wi-Fi transmission is working.</p>
	<p>Indicates USB disk is connected.</p>







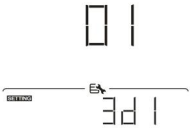
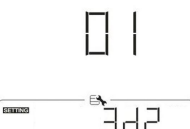
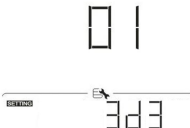
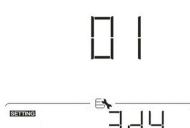

### LCD Setting





After pressing and holding “←” button for 3 seconds, the unit will enter the setting mode. Press “▲” or “▼” button to select setting programs. Press “←” button to confirm you selection or “↻” button to exit.





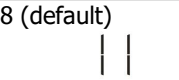

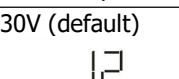
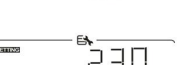
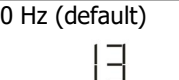
### Setting Programs:

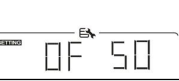
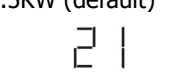





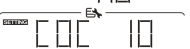
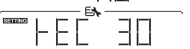
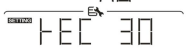

Program	Description	Selectable option	
01	Operation mode	<b>Mode 1</b> (default) Grid-tied with Backup I 	PV priority: Battery>>Load>>Grid
		<b>Mode 2</b> Grid-tied with Backup II 	PV priority: Load>>Battery>>Grid
		<b>Mode 3</b> Grid-tied with Backup III 	PV priority: Load>>Grid>>Battery
		<b>Mode 4</b> Grid-tied with Backup IV 	PV priority (peak time): Load>>Battery>>Grid. PV priority (Off-peak time): Battery>>Load>>Grid
		<b>Mode 5</b> Grid-tied with Backup V 	PV priority (Grid is high): Load>>Battery>>Grid

		<b>Mode 6</b> Grid-tied only 01 	PV priority: Grid-tied only
		<b>Mode 7</b> Off-Grid 01 	PV priority: Load >> Battery
02	Charger source priority	Solar and Utility (default) 02 	Solar energy and AC will charge battery together.
		OSO 02 	Battery is charged by Solar energy only.
		NON 02 	Charger is disabled.
03	Load supply source	SBU (default) 03 	PV>>Battery>>Grid
		SUB 03 	PV>>Grid>>Battery

04	AC Charger	Charge enabled (default) 04 ACE	Charger disabled 04 ACd
05	Feed-in to the grid function	Feed-in disabled 05 FI d	Feed-in enabled (default) 05 FI E
06	Battery feed-in to the grid	Battery feed-in enabled 06 bFE	Battery feed-in disabled (default) 06 bFd
07	AC charger ON timer: Set up time to turn on AC charger	0 (default) 07 CHG 07 0	Increment of each click is 1 hour.
08	AC charger OFF timer : Set up time to turn off AC charger	0 (default) 08 CHG OFF 0	Increment of each click is 1 hour.
09	AC output ON timer: Set up time to turn on AC output	0 (default) 09 OUT 09 0	Increment of each click is 1 hour.
0A	AC Output OFF timer: Set up time to turn off AC output	0 (default) 0A OUT OFF 0	Increment of each click is 1 hour.

11	Regulation standard (*It's requested to enter password "4743")	Available options	
		08 (default)	01: AS4777
			02: dk
			03: RD1663
			04: G83
			05: Taiwan
			06: USH
			07: USL
			08: VDE4105 (default)
			09: Korea
			10: Hongsun
			11: Sweden
			12: Changyang
			13: JET50
			14: JET60
	15: Denmark		
	16: EN50438		
	17: En50438Jak		
	18: G99		
	19: G98		
12	Nominal output voltage (*It's requested to enter password "4743")	Available options:	
		230V (default)	208V
			220V
			230V (default)
			240V
13	Nominal output frequency (*It's requested to enter password "4743")	50 Hz (default)	60Hz
			
21	Max. feed-in grid power	5.5KW (default)	The setting range is from 0 to 5.5KW. Increment of each click is 500W.
			
22	Max. charging current	30A (default)	The setting range is from 5A to 100A. Increment of each click is 5A.
			

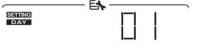
23	Max. AC charging current	30A (default) 23 	The setting range is from 5A to 100A. Increment of each click is 5A.
24	Bulk charging voltage	52.5V (default) 24 	Bulk charging voltage is preset to 52.5V by the lithium battery, user cannot modify.
25	Floating charging voltage	52.5V (default) 25 	Floating charging voltage is preset to 52.5V by the lithium battery, user cannot modify.
26	Stop discharge capacity when grid unavailable	0% (default) 26 AU 	The setting range is from 0% to 80%. Increment of each click is 1%.
27	Stop discharge capacity when grid available	10% (default) 27 AU 	The setting range is from 5% to 95%. Increment of each click is 1%.
28	Start discharge capacity(SOC) when grid available	30% (default) 28 AU 	The setting range is from 10% to 100%. Increment of each click is 1%.
29	Start discharge capacity when grid unavailable	30% (default) 29 AU 	The setting range is from 10% to 100%. Increment of each click is 1%.
2A	Max. battery discharging current in hybrid mode	120A (default) 2A 	The setting range is from 20A to 120A. Increment of each click is 10A.

2B	Generator compatible	Enabled 2b 	Disabled (default) 2b 
2C	Sleep timer for LCD backlight	60 seconds for sleep (default) 2c 	The selectable options are 00, 01 (30s), 02(60s), 10(300s) and 20(600s). If "00" is selected, LCD backlight is always on.
2D	Alarm control	Alarm on (default) 2d 	Alarm off 2d 
31	Real time setting – Minute	00 (default) 31 	The setting range is from 00 to 59.
32	Real time setting – Hour	00 (default) 32 	The setting range is from 00 to 23.
33	Real time setting – Date	01 (default) 33 	The setting range is from 01 to 31.
34	Real time setting – Month	1 (default) 34 	The setting range is from 1 to 12.

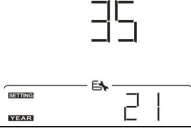
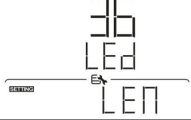
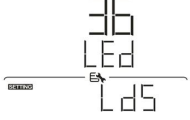
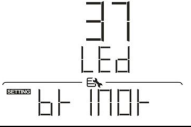
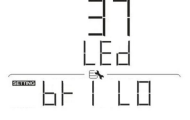
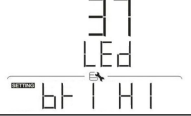
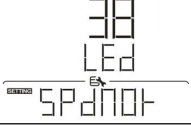
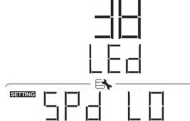
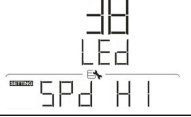
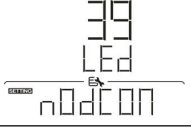
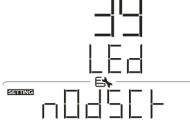
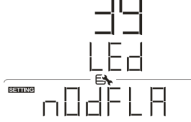

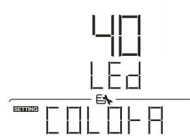
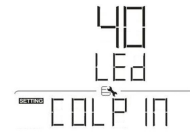
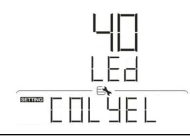
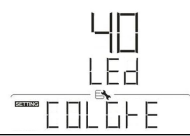
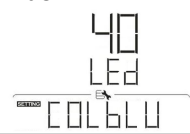

35	Real time setting – Year	21 (default) 	The setting range is from 20 to 99.
36	On/Off control for RGB LED	RGB LED Enable (Default) 	RGB LED Disable 
37	Brightness of RGB LED	Normal (default) 	Low 
		High 	
38	Lighting speed of RGB LED	Normal (default) 	Low 
		High 	
39	RGB LED effects	LED on (default) 	Scrolling 
		Flashing 	

40	Background color of RGB LED	Orange (default)		Pink	
		Yellow		Green	
		Blue			

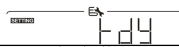

## USB Function Setting

Insert an OTG USB disk into the USB port (  ). Press and hold "↻" button for 3 seconds to enter USB OTG Function Setting Mode. These functions is data log export from the USB disk. Press "←" button to confirm you selection or "↻" button to exit.

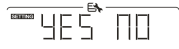
Program#	Operation Procedure	LCD Screen
Export data log  	If the selected function is ready, LCD will display "RDY". Press "←" button to confirm the selection again.	 
	<ul style="list-style-type: none"> <li>Press "▲" button to select "Yes", LED 1 will flash once every second during the process. It will only display "LOG" and all LEDs will be on after this action is complete. Then, press "↻" button to return to main screen.</li> <li>Or press "▼" button to select "NO" to return to main screen.</li> </ul>	 



If no button is pressed for 1 minute, it will automatically return to main screen.



### Error message for USB On-the-Go functions:

Error Code	Messages
U01	No USB disk is detected.
U02	USB disk is protected from copy.
U03	Document inside the USB disk with wrong format.

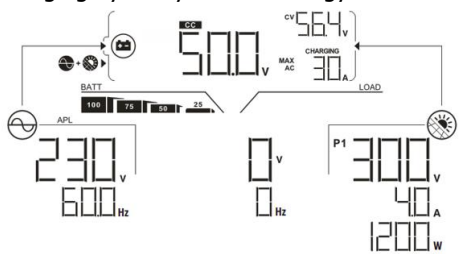
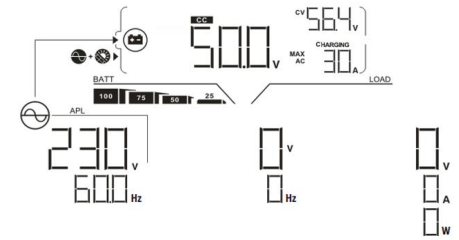
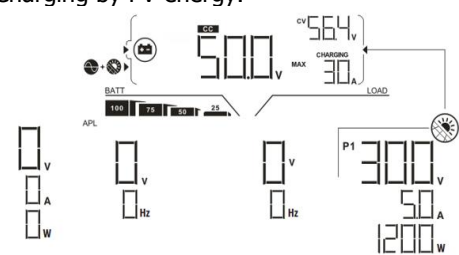
If any error occurs, error code will only show 3 seconds. After 3 seconds, it will automatically return to display screen.

## Operating Mode Description

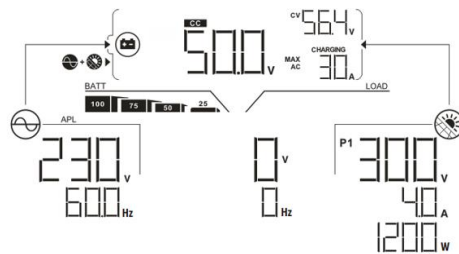
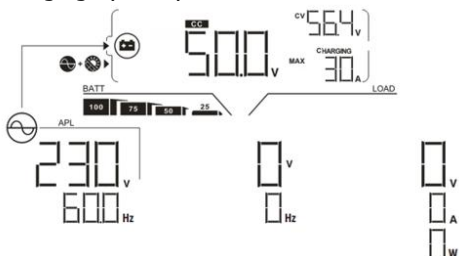
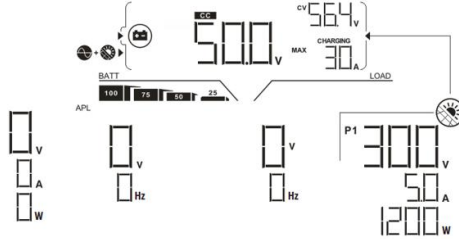
Operation mode	Description	LCD display
<p>Standby mode</p> <p><b>Note:</b> *Standby mode: The inverter is not turned on yet but at this time, the inverter can charge battery without AC output.</p>	<p>No output is supplied by the unit but it still can charge batteries.</p>	<p>Charging by utility and PV energy.</p> 
		<p>Charging by utility.</p> 
		<p>Charging by PV energy.</p> 
		<p>No charging.</p> 

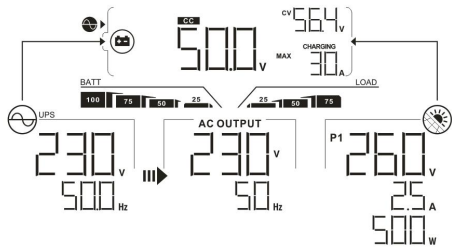
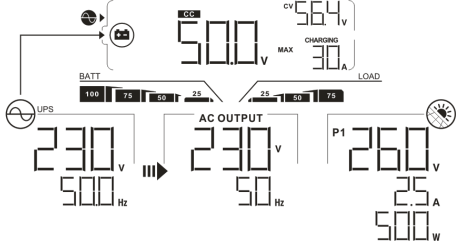
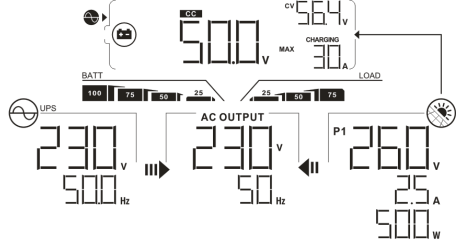

Operation mode	Description	LCD display
<p>Fault mode</p> <p>Note:</p> <p>*Fault mode: Errors are caused by inside circuit error or external reasons such as over temperature, output short circuited and so on.</p>	<p>PV energy and utility can charge batteries.</p>	<p>Charging by utility and PV energy.</p> 
		<p>Charging by utility.</p> 
		<p>Charging by PV energy.</p> 
		<p>No charging.</p> 

Operation mode	Description	LCD display
Line Mode	The unit will provide output power from the mains. It will also charge the battery at line mode.	<p>Charging by utility and PV energy.</p> 
		<p>Charging by utility.</p> 
		<p>If "SUB" (solar first) is selected as output source priority and solar energy is not sufficient to provide the load, solar energy and the utility will provide the loads and charge the battery at the same time.</p> 

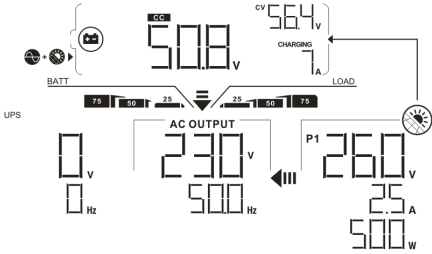
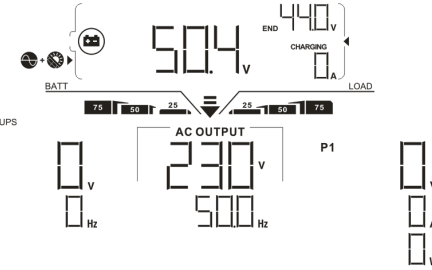
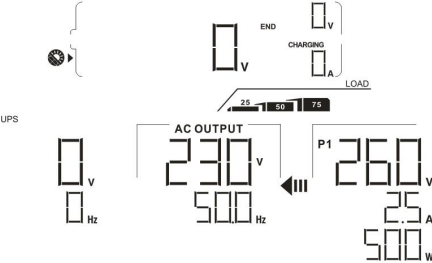
Operation mode	Description	LCD display
Line Mode	The unit will provide output power from the mains. It will also charge the battery at line mode.	<p>If either "SUB" (solar first) or "SBU" is selected as output source priority and battery is not connected, solar energy and the utility will provide the loads.</p> <p>Power from utility</p>
Battery Mode	The unit will provide output power from battery and/or PV power.	<p>Power from battery and PV energy.</p>

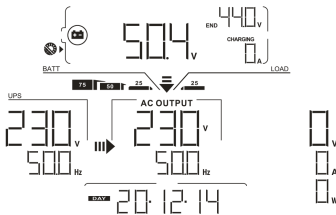
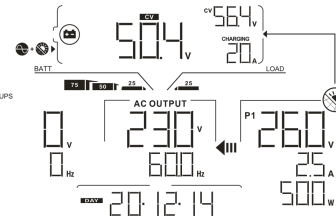
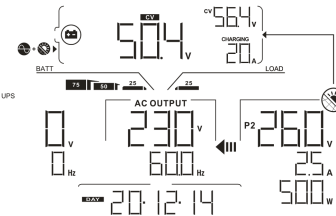

Operation mode	Description	LCD display
Battery Mode	The unit will provide output power from battery and/or PV power.	<p>PV energy will supply power to the loads and charge battery at the same time. No utility is available.</p> 
		<p>Power from battery only.</p> 
		<p>Power from PV energy only.</p> 



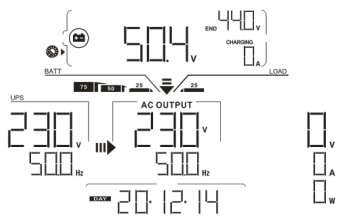
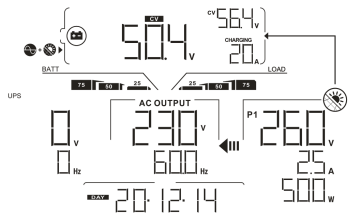
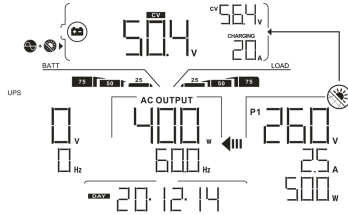

## Select Displays

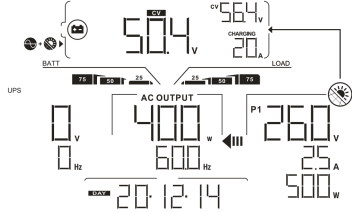
	Selectable information	LCD display
Default Display Screen	Utility voltage/ Utility frequency	<p>Input Voltage=230V, Input frequency=50Hz</p> 
	PV voltage/ PV current/ PV power (PV1 and PV2 switch every 5 seconds)	<p>PV1 voltage=260V, PV1 current=2.5A, PV1 power=500W</p> 
		<p>PV2 voltage=260V, PV2 current=2.5A, PV2 power=500W</p> 
	Battery voltage, charging stage/ Configured battery parameters/ Charging current	<p>Battery voltage=50.4V, Bulk charging voltage=56.4V, Charging current=20A</p> 

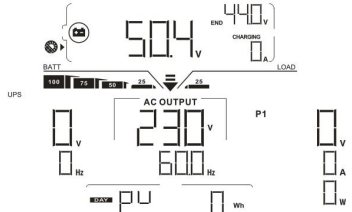
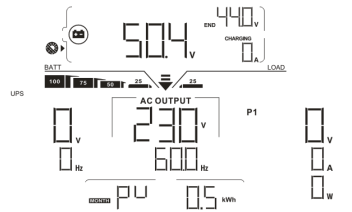
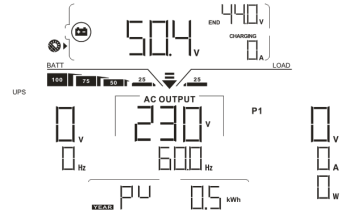
Default Display Screen		<p>Battery voltage=50.4V, Floating charging voltage=54.0V, Charging current=20A</p> 
	<p>Battery voltage, charging stage/ Configured battery parameters/ Charging current</p>	<p>Battery voltage=50.4V, Low DC cut-off voltage=44.0V, charging current=0A</p> 
	<p>Output voltage, load in Watt / Output frequency</p>	<p>Output voltage=230V, Output frequency=60Hz</p> 
		<p>Load in Watt=400W, Output frequency=60 Hz</p> 



<p>Default Display Screen</p>	<p>Real date.</p>	<p>Real date Dec 14, 2020.</p> 
<p>Real time.</p>		<p>Real time 11:31</p> 
<p>PV energy generated today</p>		<p>PV energy generated today = 0Wh.</p> 
<p>PV energy generated this month</p>		<p>PV energy generated this month = 0.5kWh.</p> 
<p>PV energy generated this year</p>		<p>PV energy generated this year = 0.5kWh.</p> 

<p>Total PV energy generated</p>	<p>Total PV energy generated = 0.5kWh.</p>  <p>The LCD display shows the following information: 50.4 V (PV), 440 V (END), 20 A (CHARGING), 230 V (AC OUTPUT), 600 Hz (AC OUTPUT), 0.5 kWh (PV), and PU 0.5 kWh (PV).</p>
<p>Battery pack numbers &amp; Battery group numbers</p>	<p>Battery pack numbers = 3, battery group numbers = 1</p>  <p>The LCD display shows the following information: 50.4 V (PV), 440 V (END), 20 A (CHARGING), 230 V (AC OUTPUT), 500 Hz (AC OUTPUT), and P03G01 (Battery pack numbers = 3, battery group numbers = 1).</p>
<p>Main CPU version checking.</p>	<p>Main CPU version 00.41.</p>  <p>The LCD display shows the following information: 50.4 V (PV), 440 V (END), 20 A (CHARGING), 230 V (AC OUTPUT), 600 Hz (AC OUTPUT), and U10041 (Main CPU version).</p>
<p>Secondary CPU version checking.</p>	<p>Secondary CPU version 00.44.</p>  <p>The LCD display shows the following information: 50.4 V (PV), 440 V (END), 20 A (CHARGING), 230 V (AC OUTPUT), 600 Hz (AC OUTPUT), and U20044 (Secondary CPU version).</p>
<p>LCD MCU version checking.</p>	<p>LCD MCU version 28.00.</p>  <p>The LCD display shows the following information: 50.4 V (PV), 440 V (END), 20 A (CHARGING), 230 V (AC OUTPUT), 600 Hz (AC OUTPUT), and U32800 (LCD MCU version).</p>

## 10. Maintenance & Cleaning

Check the following points to ensure proper operation of the whole solar system at regular intervals.

- Ensure all connectors of this inverter are cleaned all the time.
- Before cleaning the solar panels, be sure to turn off PV DC breakers.
- Clean the solar panels during the cool time of the day, whenever it is visibly dirty.
- Periodically inspect the system to make sure that all wires and supports are securely fastened in place.

**WARNING:** There are no user-replaceable parts inside the inverter. Do not attempt to service the unit by yourself.

### Battery Maintenance

- Servicing of batteries should be performed or supervised by personnel with knowledge about batteries and the required precautions.
- Replace the batteries with the same type and number of batteries or battery packs.
- The following precautions should be observed when working on batteries:
  - a) Remove watches, rings, or other metal objects.
  - b) Use tools with insulated handles.
  - c) Wear rubber gloves and boots.
  - d) Do not lay tools or metal parts on top of batteries.
  - e) Disconnect charging source prior to connecting or disconnecting battery terminals.
  - f) Determine if battery is inadvertently grounded. If inadvertently grounded, remove source from ground. Contact with any part of a grounded battery can result in electric shock. The likelihood of such shock can be reduced if such grounds are removed during installation and maintenance (applicable to equipment and remote battery supplies without a grounded supply circuit).

**CAUTION:** A battery can present a risk of electric shock and high short-circuit current.

**CAUTION:** Do not dispose of batteries in a fire. The batteries may explode.

**CAUTION:** Do not open or mutilate batteries. Released electrolyte is harmful to the skin and eyes. It may be toxic.

## 11. Trouble Shooting

When there is no information displaying in the LCD, please check if PV module/battery/grid connection is correctly connected.

**NOTE:** The warning and fault information can be recorded by remote monitoring software.

### 11-1. Fault code reference

When a fault occurs, the icon **FAULT** will flash as a reminder. See below for fault codes for reference.

Situation		Solution
Code	Fault Event	
01	DC bus voltage exceeds the upper threshold.	Disconnect AC circuit breaker first. Then, disconnect DC circuit breaker. Until LCD screen completely shuts down, turn on DC breaker first. It will show "No Utility" in LCD screen. Then, turn on AC breaker. After 300 seconds, the system will automatically connect to the grid. If the error message still remains, please contact your installer.
02	DC bus voltage falls below the lower threshold.	
03	DC bus voltage soft-start is timeout.	
04	Inverter soft-start is timeout.	
05	An inverter overcurrent event is detected.	
07	Relay failure is detected.	
08	DC component in the output current exceeds the upper threshold	
11	Over-current on PV input is detected	
14	Inverter DC component exceeds the allowable range	
16	Leakage current CT failed	
06	Over temperature fault	The internal temperature is higher than specified temperature. Leave inverter to cool down to room temperature. If the error message still remains, please contact your installer.
09	PV input voltage exceeds the upper threshold	Check if the open circuit voltage of PV modules is higher than 500VDC. If PV open circuit voltage is less than 500VDC and the error message remains, please contact your installer.
10	Auxiliary power* failed *Auxiliary power means switch power supply.	Turn off the inverter. Then, restart the inverter. If the error message still remains, please contact your installer.

Situation		Solution
Code	Fault Event	
12	Leakage current exceeds the allowable range	The ground voltage is too high. Please disconnect AC breaker first and then DC breaker. Check if grounding is connected properly after LCD screen completely shuts down. If grounding is correctly connected, turn on DC breaker. After it displays "No Utility" in LCD screen, turn on AC breaker. After 300 seconds, the system will automatically connect to the grid. If the error message still remains, please contact your installer.
13	PV insulation resistance is too low	Check if the impedance between positive and negative poles to the ground is greater than 1MΩ. If the impedance is lower than 1MΩ, please contact your installer.
15	A difference occurred in the readings from the main and secondary controllers	Please disconnect AC breaker first and then disconnect DC breaker. After LCD screen is completely off, turn on DC breaker. Until it shows "No Utility" in LCD display, turn on AC breaker. After 300 seconds, the system will automatically connect to the grid.
17	Communication with the main and secondary controllers is interrupted	If error message remains, please contact your installer.
20	Discharge circuit fault	
21	Soft start in battery discharge fails	
22	Charging voltage is too high	Check if the connection between battery and inverter is good. Make sure battery condition is ok. Then, restart the inverter. If error message remains, please contact your installer.
23	Overload fault	Remove excessive loads. Be sure the total power consumption of the connected loads are less than that of the maximum which this inverter can support. Then, restart the inverter.
24	Battery disconnected	Check if battery cable is connected firmly. If error message remains, please contact your installer.
25	Inverter current is too high for a long time	Remove excessive loads. Then, restart the inverter.

<b>Situation</b>		<b>Solution</b>
<b>Code</b>	<b>Fault Event</b>	
26	Short circuited on inverter output	Turn off the inverter. Disconnect AC circuit breaker first. Then, disconnect DC circuit breaker and then disconnect the loads. Please check if load circuit is ok. After removing the error, turn on the PV DC breaker and battery breaker. Turn on the inverter. If error message remains, please contact your installer.
27	Fan fault	Please check if fans are running ok. If fans are running ok, please shut down inverter first and then restart it. If fans stop running or error message remains after restart the inverter, please contact your installer.
28	OP Current Sensor fault	Shut down the inverter completely. Restart the inverter to see if it's ok. If error message still remains, please contact your installer.
29	Charger failure	Shut down the inverter completely. Restart the inverter to see if it's ok. If error message still remains, please contact your installer.
30	Version mismatch between controller board and power board	Shut down the inverter completely. Restart the inverter to see if it's ok. If error message still remains, please contact your installer.
31	Reverse connection of input and output wires	Shut down the inverter completely. Check if grid wires are connected to AC output terminals. If mis-connected, re-connect it correctly. And turn on the inverter again. If error message still remains, please contact your installer.





## 11-2. Warning Reference Codes

When a warning event occurs, the icon  will flash as a reminder.

### 11-2-1. General warning codes

Situation		Solution
Code	Warning Event	
02	Internal EEPROM failed	Restart the unit again. If problem still exists, please contact your installer.
04	Battery low	Recharge or replace the battery.
07	Overload	Reduce connected load.
17	Battery open	Re-connect the battery.
20	Over temperature	<ul style="list-style-type: none"> <li>● Check the ventilation around the unit and try to reduce connected load.</li> <li>● Check if fans run normally.</li> </ul>
32	Communication lost between inverter and display panel	Restart the unit again. If problem still exists, please contact your installer.

### 11-2-2. BMS warning codes

Code	Description
60 	If battery status is not allowed to charge and discharge after the communication between the inverter and battery is successful, it will show code 60 to stop charging and discharging battery.
61 	<p>Communication lost (only available when the battery type is not setting as "AGM", "Flooded", "User-Defined" or "ISC".)</p> <ul style="list-style-type: none"> <li>● After battery is connected, communication signal is not detected for 3 minutes, buzzer will beep. After 10 minutes, inverter will stop charging and discharging to lithium battery.</li> <li>● Communication lost occurs after the inverter and battery is connected successfully, buzzer beeps immediately.</li> </ul>
69 	If battery status is not allowed to charge after the communication between the inverter and battery is successful, it will show code 69 to stop charging battery.
70 	If battery status must to be charged after the communication between the inverter and battery is successful, it will show code 70 to charge battery.
71 	If battery status is not allowed to discharge after the communication between the inverter and battery is successful, it will show code 71 to stop discharging battery.

## 12. Specifications

<b>MODEL</b>	<b>5.5KW</b>
<b>Maximum PV Input Power</b>	6500 W
<b>Rated Output Power</b>	5500 W
<b>Maximum Charging Power</b>	4800 W
<b>PV INPUT (DC)</b>	
Nominal DC Voltage / Maximum DC Voltage	360 VDC / 500 VDC
Start-up Voltage / Initial Feeding Voltage	116 VDC / 150 VDC
MPP Voltage Range	120 VDC ~ 450 VDC
Number of MPP Trackers / Maximum Input Current	2 / 2 x 13 A
<b>GRID INPUT</b>	
Nominal Output Voltage	208/220/230/240 VAC
Output Voltage Range	184 - 264.5 VAC*
Max. Output Current	23.9A*
<b>AC INPUT</b>	
AC Start-up Voltage / Auto Restart Voltage	120 - 140 VAC / 180 VAC
Acceptable Input Voltage Range	170 -280 VAC
Maximum AC Input Current	40 A
<b>BATTERY MODE OUTPUT (AC)</b>	
Nominal Output Voltage	208/220/230/240 VAC
Efficiency (DC to AC)	93%
<b>BATTERY &amp; CHARGER</b>	
Nominal DC Voltage	48 VDC
Maximum Charging Current	100 A
<b>PHYSICAL</b>	
Dimension, D X W X H (mm)	214 x 621 x 500
Net Weight (kgs)	25
<b>BATTERY MODULE</b>	
<b>CAPACITY</b>	4800Wh
<b>PARAMETERS</b>	
Nominal Voltage	51.2VDC
Full Charge Voltage(FC)	56V
Full Discharge Voltage(FD)	43.2V
Typical Capacity	200 Ah
Max Continuous Discharging Current	120A
Protection	BMS, Breaker
Charge Voltage	56 V
Charge Current	100A
Standard Charge method	CC (Constant current) charge to FC, CV (Constant voltage FC) charge till charge current decline to <0.05C
Inner Resistance	<20m ohm
Dimension, D X W X H (mm)	214 x 621 x 550
Net Weight (kgs)	84

\*Product specifications are subject to change without further notice



# Appendix I: The Wi-Fi Operation Guide

## 1. Introduction

Wi-Fi module can enable wireless communication between off-grid inverters and monitoring platform. Users have complete and remote monitoring and controlling experience for inverters when combining Wi-Fi module with SolarPower APP, available for both iOS and Android based device. All data loggers and parameters are saved in iCloud. The major functions of this APP:

- Delivers device status during normal operation.
- Allows to configure device setting after installation.
- Notifies users when a warning or alarm occurs.
- Allows users to query inverter history data.

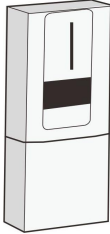

## 2.SolarPower App Installation

### 2-1. Download and install APP

*Operating system requirement for your smart phone:*

 iOS system supports iOS 9.0 and above

 Android system supports Android 5.0 and above

Please scan the following QR code with your smart phone and download SolarPower App.



Android system





iOS system

Or you may find "SolarPower Wi-Fi" app from the Apple® Store or "SolarPower" in Google® Play Store.



## 2-2. Initial Setup

### Step 1: Registration at first time

After the installation, please tap the shortcut icon  to access the APP on your mobile screen. In the screen, tap "Register" to access "User Registration" page. Fill out all required information accordingly. You can scan the Wi-Fi Module PN by tapping icon . Tap "Register" after you have completed the registration.

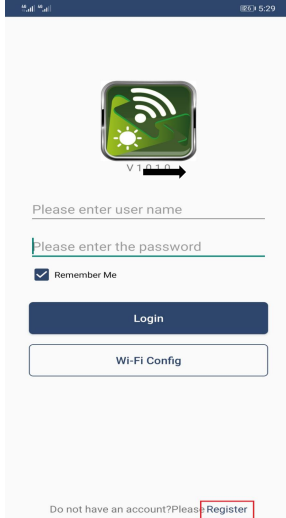

The screenshot shows the Login page of the application. At the top, there is a green Wi-Fi Module icon with a white arrow pointing right. Below the icon, there are two input fields: "Please enter user name" and "Please enter the password". A checkbox labeled "Remember Me" is checked. Below the input fields, there is a blue "Login" button and a white "Wi-Fi Config" button. At the bottom, there is a link that says "Do not have an account? Please [Register](#)".

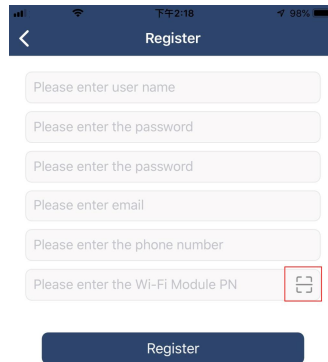

The screenshot shows the Register page of the application. At the top, there is a blue header with a back arrow and the word "Register". Below the header, there are five input fields: "Please enter user name", "Please enter the password", "Please enter the password", "Please enter email", and "Please enter the phone number". Below these fields, there is a sixth input field labeled "Please enter the Wi-Fi Module PN" with a QR code icon to its right. At the bottom, there is a blue "Register" button.

Then, a "Registration success" window will pop up. Tap "Go now" to continue setting local Wi-Fi network connection.

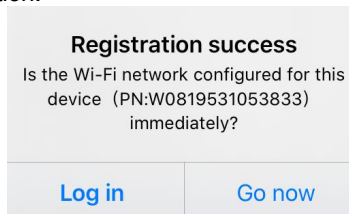

The screenshot shows a "Registration success" dialog box. The text inside reads: "Registration success" followed by "Is the Wi-Fi network configured for this device (PN:W0819531053833) immediately?". At the bottom, there are two buttons: "Log in" and "Go now".

## Step 2: Local Wi-Fi Network Configuration

Now, you are in "Wi-Fi Config" page. There are detailed setup procedure listed in "How to connect?" section and you may follow it to connect Wi-Fi.

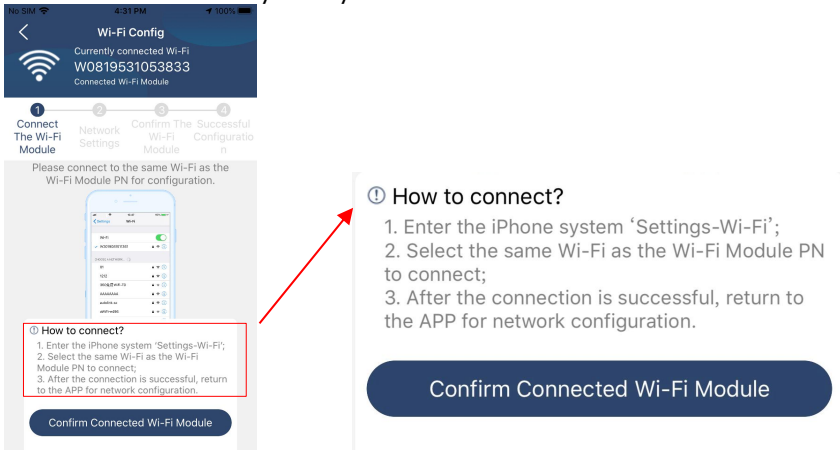

**How to connect?**

1. Enter the iPhone system 'Settings-Wi-Fi';
2. Select the same Wi-Fi as the Wi-Fi Module PN to connect;
3. After the connection is successful, return to the APP for network configuration.

Confirm Connected Wi-Fi Module

Enter the "Settings→Wi-Fi" and select connected Wi-Fi name. The connected Wi-Fi name is the same to your Wi-Fi PN number and enter default password "12345678".

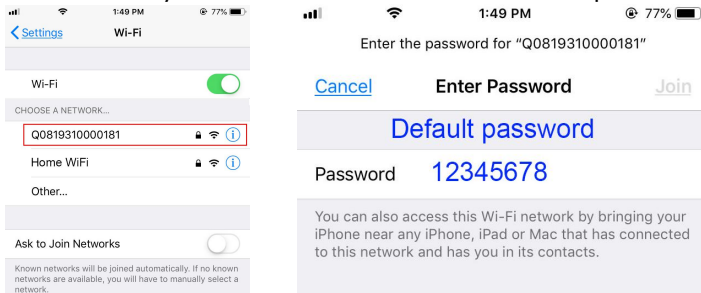

Enter the password for "Q0819310000181"

Cancel Enter Password Join

Default password

Password 12345678

You can also access this Wi-Fi network by bringing your iPhone near any iPhone, iPad or Mac that has connected to this network and has you in its contacts.

Then, return to SolarPower APP and tap "Confirm Connected Wi-Fi Module" button when Wi-Fi Model is connected successfully.

## Step 3: Wi-Fi Network settings

Tap  icon to select your local Wi-Fi router name (to access the internet) and enter password.

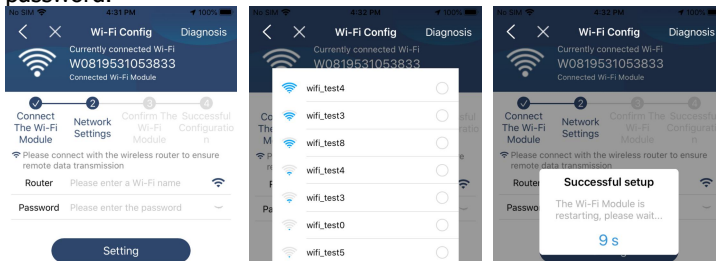

Wi-Fi Config Diagnosis

Currently connected Wi-Fi W0819531053833

Connect The Wi-Fi Module Network Settings Wi-Fi Configuration

Please connect with the wireless router to ensure remote data transmission

Router Please enter a Wi-Fi name

Password Please enter the password

Setting

wif\_test4

wif\_test3

wif\_test8

wif\_test4

wif\_test3

wif\_test0

wif\_test5

Successful setup

The Wi-Fi Module is restarting, please wait...

9 s

**Step 4:** Tap “Confirm” to complete the Wi-Fi configuration between the Wi-Fi Module and the Internet.



If the connection fails, please repeat Step 2 and 3.

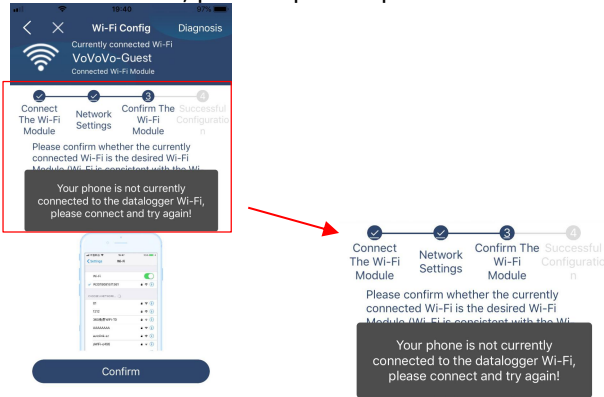

**Step 5: Diagnose Function**

If the module is not monitoring properly, please tap “**Diagnosis**” on the top right corner of the screen for further details. It will show repair suggestion. Please follow it to fix the problem. Then, repeat the steps in the chapter 4.2 to re-set network setting. After all setting, tap “Rediagnosis” to re-connect again.

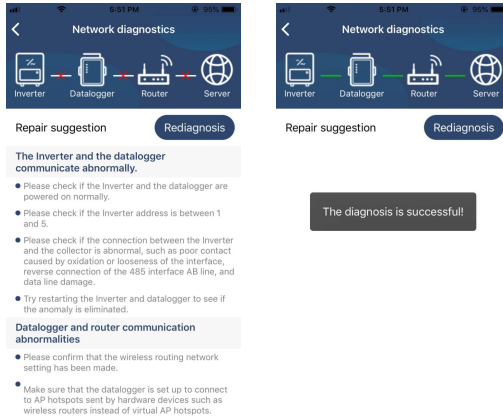

### 2-3. Login and APP Main Function

After finishing the registration and local Wi-Fi configuration, enter registered name and password to login.

Note: Tick "Remember Me" for your login convenience afterwards.

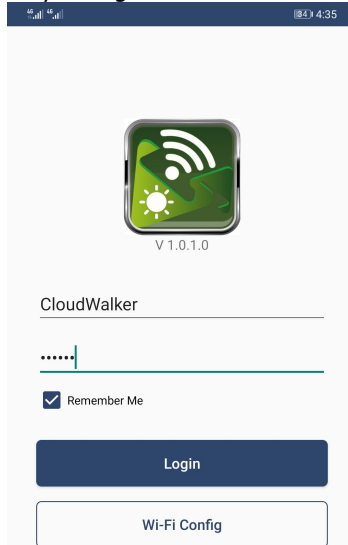

### 3. SolarPower APP Operation

#### 3-1. Overview

After login is successfully, you can access "Overview" page to have overview of your monitoring devices, including operation status (normal, offline, alarm, and fault) as below diagram.

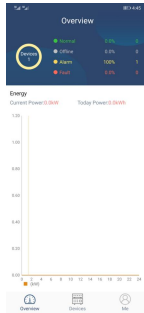

### 3-2. Devices

Tap the icon , you can enter Device List page. You can review all of the devices in "Device List". You also can add or delete device in this page.

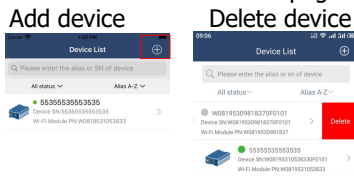

Tap  icon on the top right corner and enter part number by scanning QR code to add device. The QR code label is pasted on the side of inverter module. Tap "Confirm" to add device in the Device list. Time zone and part number are required information. Tap "Confirm" to complete and the added Wi-Fi module can be reviewed in the Device list.

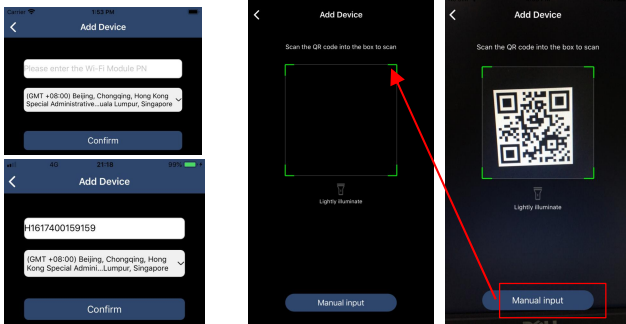

### 3-3. ME

In ME page, users can modify “My information”, including 【User’s Photo】 , 【Account security】 , 【About】 , 【Clear cache】 and 【Log-out】 , shown as below diagrams.

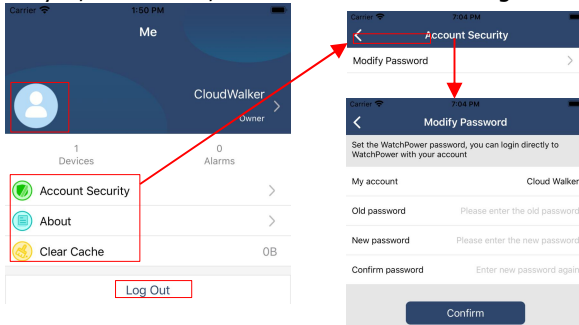

### 3-4. Device List

In Device List page, you can pull down to refresh the device information and then tap any device you want to check up for its real-time status and related information as well as to change parameter settings. Please refer to the parameter setting list.

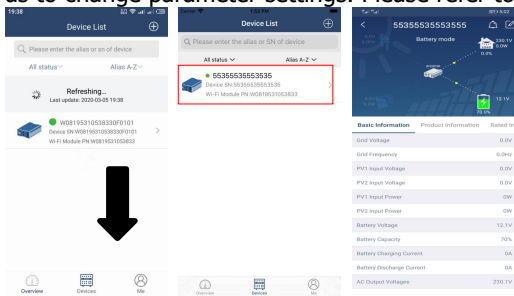

### 3-5. Monitoring Information and Parameter Setting

#### Device Mode

On the top of screen, there is a dynamic power flow chart to show live operation. It contains five icons to present PV power, inverter, load, utility and battery. Based on your inverter status, there will be 【Standby Mode】 , 【Line Mode】 and 【Battery Mode】 .

【Standby Mode】 Inverter will not power the load until “ON” switch is pressed. Qualified utility or PV power can charge battery in standby mode.





【Line Mode】 Inverter will power the load from the utility with or without PV power. Qualified utility or PV power can charge battery.



**【Battery Mode】** Inverter will power the load from the battery with or without PV power. Only PV power can charge battery at this mode.



### Device Alarm and Name Modification

In this page, tap the  icon on the top right corner to enter the device alarm page. Then, you can review alarm history and detailed information. After tapping the  icon on the top right corner, a blank input column will pop up. Then, you can edit the name for your device and tap "Confirm" to complete name modification.

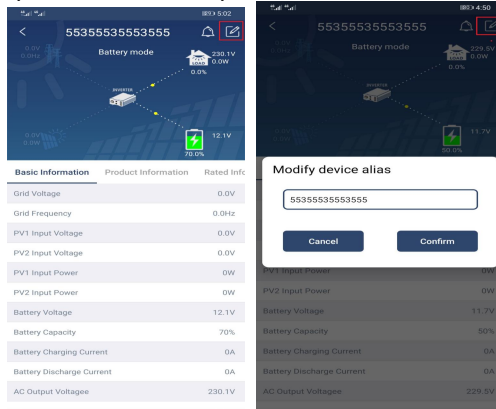

### Device Information Data

Users can check up **【Basic Information】**, **【Product Information】**, **【Rated information】**, **【History】** and **【Wi-Fi Module Information】** by swiping left.

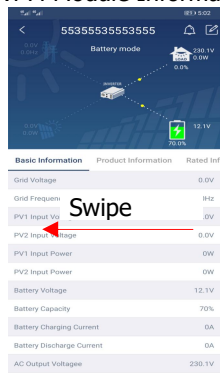



【Basic Information】 displays basic information of the inverter, including AC voltage, AC frequency, PV input voltage, Battery voltage, Battery capacity, Charging current, Discharging current, Output voltage, Output frequency, Output apparent power, Output active power and Load percent. Please slide up to see more basic information.

【Production Information】 displays Model type (Inverter type), Main CPU version, Bluetooth CPU version and secondary CPU version.

【Rated Information】 displays information of Nominal AC voltage, Nominal AC current, Rated battery voltage, Nominal output voltage, Nominal output frequency, Nominal output current, Nominal output apparent power and Nominal output active power. Please slide up to see more rated information.

【History】 displays the records of unit information and setting.

【Wi-Fi Module Information】 displays of Wi-Fi Module PN, status and firmware version.

### Parameter Setting

This page is to activate some features and set up parameters for inverters. Please be noted that the listing in “Parameter Setting” page in below diagram may differ from the models of monitored inverters. Here is briefly illustrate partial setting: 【Output Setting】 , 【Battery Parameter Setting】 , 【Enable/ Disable items】 , 【Others Settings】 , 【Restore to the defaults】 Please refer to product manual when necessary.

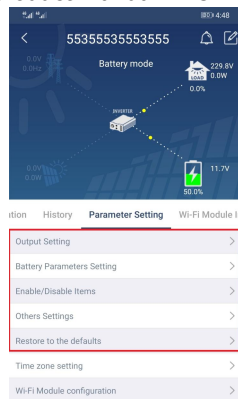

There are three ways to modify setting and they vary according to each parameter.

- Listing options to change values by tapping one of it.
- Activate/Shut down functions by clicking “Enable” or “Disable” button.
- Changing values by clicking arrows or entering the numbers directly in the column.

Each function setting is saved by clicking “Set” button.

Please refer to below parameter setting list for an overall description and be noted that the available parameters may vary depending on different models. Please always see the original product manual for detailed setting instructions.

Parameter setting list:

Item	Description	
Output Setting	Output Source Priority	Output source priority selection
	Input Voltage Range	Input voltage range selection
	AC Output Rating Voltage	To set output rating voltage
	AC Output Rating Frequency	To set output rating frequency
Battery Parameters Setting	Battery Type	Select connected battery type
	Battery Cut-off Voltage	Set battery cut-off voltage
	Bulk Charging Voltage	Set battery bulk charging voltage
	Battery Float Voltage	Set battery floating charging voltage
	Max Charging Current	To configure total charging current for solar and utility chargers.
	Max AC Charging Current	Set maximum utility charging current
	Charging Source Priority	To configure charger source priority
	Back To Grid Voltage	Set battery voltage to stop discharging when grid is available
	Back To Discharge Voltage	Set battery voltage to stop charging when grid is available
Enable/Disable Items	Overload Auto Restart	If disabled, the unit won't be restarted after overload occurs.
	Overload Temperature Auto Restart	If disabled, the unit won't be restarted after over-temperature fault is solved.
	Overload Bypass	If enabled, the unit will enter bypass mode when overload occurs.
	Beeps While Primary Source Interrupt	If enabled, buzzer will alarm when primary source is abnormal.
	Buzzer	If disabled, buzzer won't be on when alarm/fault occurred.
	Backlight	If disabled, LCD backlight will be off when panel button is not operated for 1 minute.
	LCD Screen Return To Default Display	If selected, no matter how users switch display screen, it will automatically return to default display screen (Input voltage /output voltage) after no button is pressed for 1 minute.
	Fault Code Record	If enabled, fault code will be recorded in the inverter when any fault happens.

Item		Description
Others Settings	Solar Supply Priority	Set solar power as priority to charge the battery or to power the load.
	Reset PV Energy Storage	If clicked, PV energy storage data will be reset.
	Start Time For Enable AC Charge Working	The setting range of start charging time for AC charger is from 00:00 to 23:00. The increment of each click is 1 hour.
	Ending Time For Enable AC Charge Working	The setting range of stop charging time for AC charger is from 00:00 to 23:00. The increment of each click is 1 hour.
	Scheduled Time For AC Output On	The setting range of scheduled time for AC output on is from 00:00 to 23:00. The increment of each click is 1 hour.
	Scheduled Time For AC Output Off	The setting range of scheduled time for AC output off is from 00:00 to 23:00. The increment of each click is 1 hour.
	Country Customized Regulations	Select inverter installed area to meet local regulation.
	Set Date Time	Set date time.
Restore to the defaults	This function is to restore all settings back to default settings.	

# Appendix II: Energy Meter Installation Guide

## 1. Introduction

By using the equipped bi-directional Energy meter, ESS system could managing the PV energy to achieve spontaneous self-use. Connection diagram showed as following.

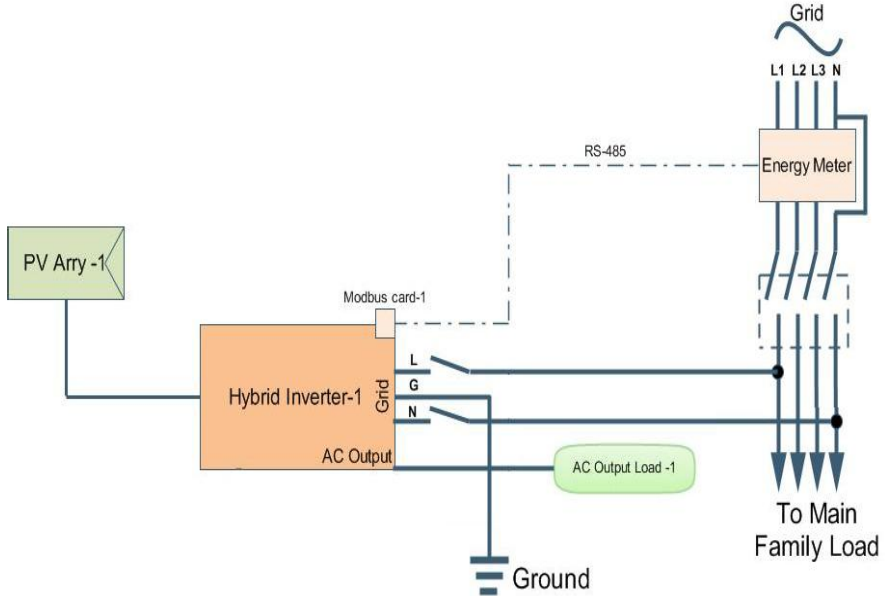

## 2. Wiring Connection

Please install the Energy meter between Grid Distribution board and AC input of ESS. All parameters of Modbus card had been setup in factory correctly, so no need to adjust the card. Just insert communication cable between Inverter Modbus card and external energy meter.

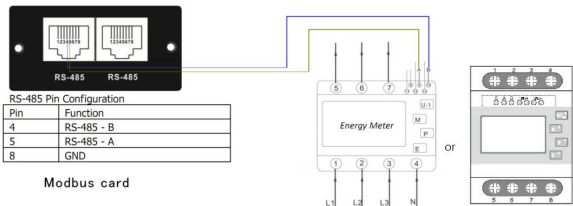
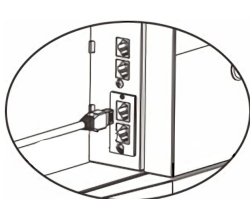

Single inverter connection

### 3. Setup

Note to adjust the setting on the operation mode as "Grid-tied with backup II" from SolarPower monitoring software or LCD menu, then Inverter could get power data from Energy meter to manage self-consumption.

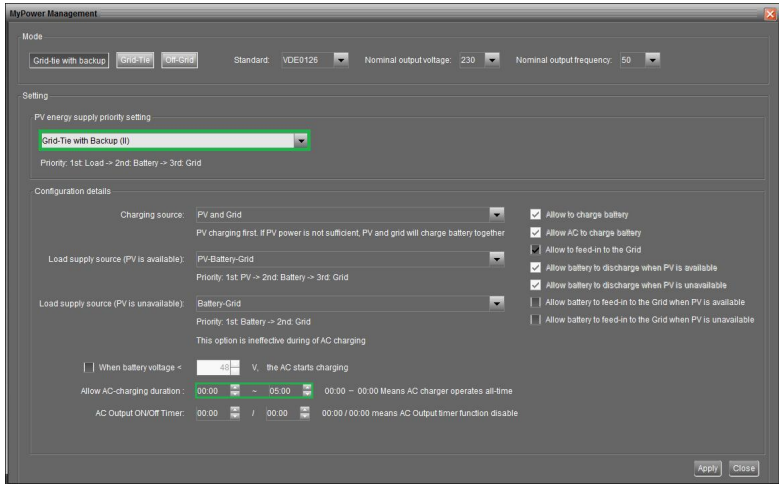

Setup by SolarPower

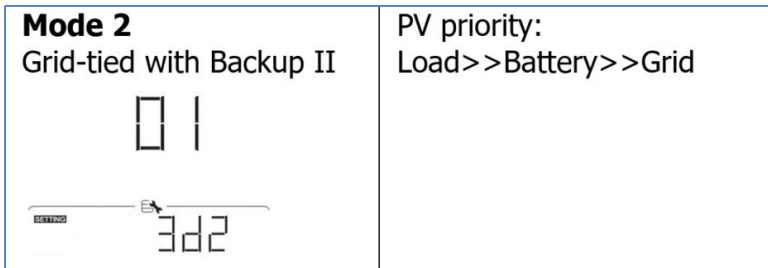

Setup by LCD menu

## 4. Troubleshooting

In case communication between Energy meter and Inverter doesn't work, please verify the physical setting on both Energy meter and Modbus card again.

### A. (Checking Energy meter)

Enter set-up mode, verify if the parameters set inside the energy meter are correct.

- RS485 address: 01
- Baud-rate: 19200bps
- Parity check: none
- Stop bit: 1

### B. (Checking Modbus card)

Verify if the ID setting inside the Modbus card are correct

- Address ID (SW1) set as 01

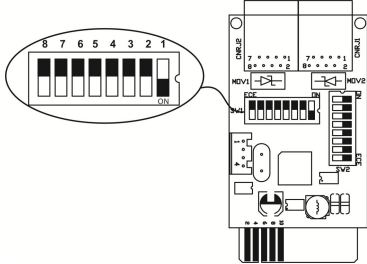

- Parity bit and RS485 Resistance (SW3) set as: ON, ON, ON, OFF, ON, ON, ON.

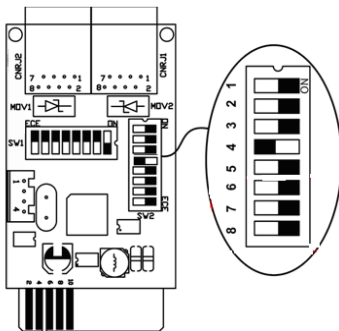

- C. If necessary, detail information about the Energy meter could refer to the document which named as Energy-meter manual.