

Assembly Manual

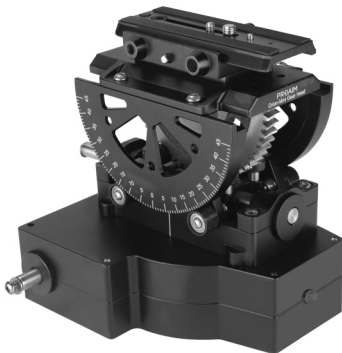

What's In The Box

Please inspect the contents of your shipped package to ensure you have received everything that is listed below.



Orion Mini Geared Head



3 x Cranks Handles



3 x Screws & Washers



100mm Bowl Base



Allen Key T-Type
(Size:-4mm)



Bag Packing

All rights reserved.

No part of this document may be reproduced, stored in a retrieval system, or transmitted by any form or by any means, electronic, mechanical, photo-copying, recording, or otherwise, except as may be expressly permitted by the applicable copyright statutes or in writing by the Publisher.

Orion Mini Geared Head Setup

- Detach half bowl from 100mm bowl base.

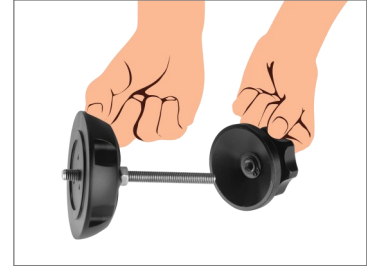

- Now attach half bowl to the bottom of Orion mini and secure it with the help of wrench (Not Included).

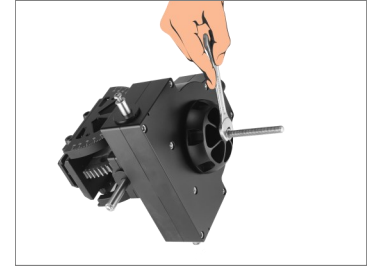
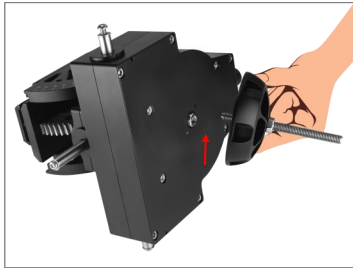

- Here is the final view of bowl attaching.



- Loose screw and washer from the side ends Orion mini with the help of provided Allen key.

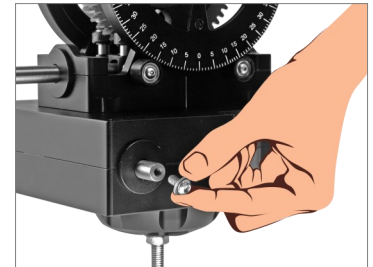
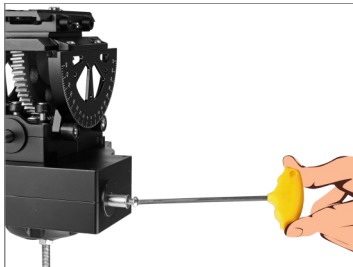

- Now attach crank handle after removing screw & washer.

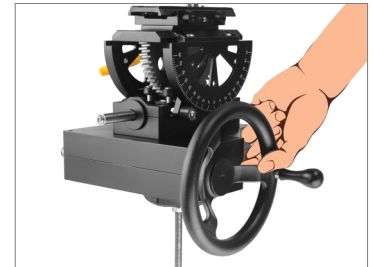

- Secure it by attaching screw and washer with the help of provided Allen key.



- Tighten the ratchet knob on the plate to secure the camera setup.



- Insert the thread of the Orion Mini Geared Head into the 100mm bowl tripod stand **(Not Included)**.

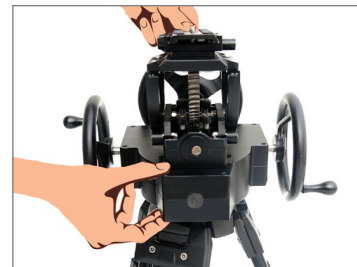

- Secure the thread from the bottom with the tightening knob.

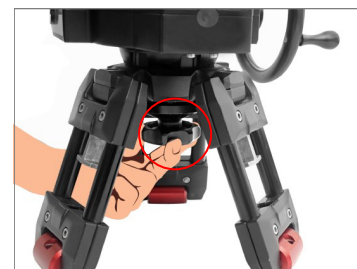
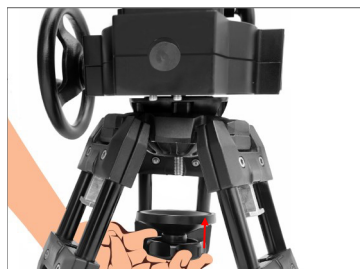

- Loosen the ratchet knob on the top plate of the Geared Head and press the push button on the other side.

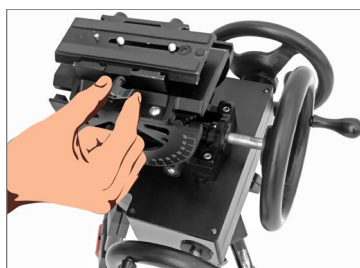

- Slide out the top plate.



- Attach the plate to the camera base **(Not Included)** and tighten its bolt with a screwdriver **(Not Included)**. Then, slide the plate on the top of the Geared Head.

NOTE: Orion Mini Gear Head works with most of the DSLR Video Cameras.



- Tighten the ratchet knob on the plate to secure the camera setup.

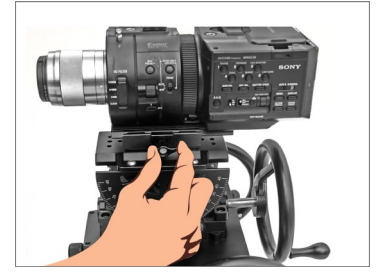

NOTE: The Geared Head has sturdy cranks for Panning & Tilting. The tilting crank offers one-axis movement and allows 45° tilting on each side. The panning crank offers 360° panning for accurate panoramic shots.

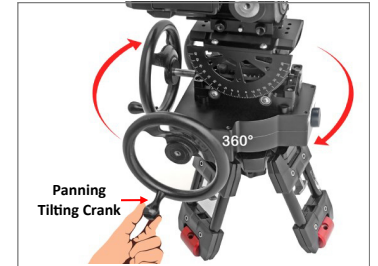
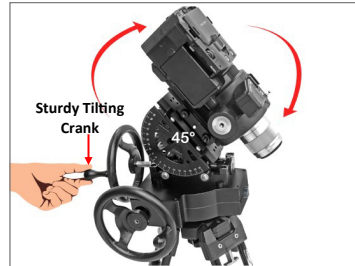

- Orion Mini Geared Head Setup is ready to use.



**YOUR PROAIM ORION MINI CAMERA GEARED HEAD
ALL DRESSED UP AND READY TO GO!**



(SHOWN WITH OPTIONAL ACCESSORIES)

Warranty: We offer one year warranty for our products from date of purchase. Within this period of time, we will repair it without charge for labor or parts. Warranty doesn't cover transportation costs nor does it cover a product subjected to misuse or accidental damage. Warranty repairs are subjected to inspection and evaluation by us.

Liability: We are not liable for damage caused by products that we do not supply or from mishandling in transit, accident, misuse, neglect, lack of care of the product, or service by anyone other than our company.

Contact Us: If you are dissatisfied, please contact us immediately. We promise our utmost support and care until you use our product.