

## Assembly Manual



### ■ What's In The Box

Please inspect the contents of your shipped package to ensure you have received everything that is listed below.

- 22ft Long Telescopic Camera Jib Crane
- 150mm Bowl Jib Stand with Spreader (LW-150)
- D-33 Pro Camera Dolly
- Sr. Pan Tilt Head with Accessories (PT-SR)
- Zoom Control (P-ZC-3DV)
- Customized Storage cases for Camera Jib Arm, Jib Stand & Accessories
- **Complimentary** Tools and Tool Pouch/Wrap

---

All rights reserved.

No part of this document may be reproduced, stored in a retrieval system, or transmitted by any form or by any means, electronic, mechanical, photo-copying, recording, or otherwise, except as may be expressly permitted by the applicable copyright statutes or in writing by the Publisher.

### First Packing

- Jib Sections

### Second Packing

- Jib Sections

### Third Packing

- Accessories of Jib Crane

### Fourth Packing

- Gravity Jib Stand

### Fifth Packing

- Dolly Pack

### Sixth Packing

- Sr Pan-tilt Head



**NOTE:** We send the Jib sections in two boxes. One box has the sections with pipe packing, and the other cardboard box has the rest. **We only send one pipe packing for the jib sections.** We send the Dolly in a cardboard box.

### Packaging Material of Box 1 & 2: 7x Jib Sections



### Packaging Material of Box 3: Accessories of Jib Crane



Joystick Controller Bracket



Hub Section



Head Platform with Bolt, Shaft Collars, Washers and Nut



6 x Shanks for Joining Arms



Levelling Cable



6 x Pins for Joining jibs



7 x Black Velcro



2 x pins



Shank



Hub Mounting knob



Turn buckle



12 x Washers



Rear Frame Mounting Rod



Complimentary Tools Pouch

### Packaging Material of Box 4: Gravity Stand



Gravity Stand

Ultimate Gravity Stand Bowl



(P-RB-SP) Spreader



13mm Spanner



19mm Spanner



Stopper

### Packaging Material of Carton Box 5: Camera Dolly



D-33 Pro Camera Dolly



3 x Tripod holder



17mm Spanner



1 x 3/16" L-Type Allen Key

**Packaging Material of Box 6: Sr. Pan and Tilt Head with Accessories (PT-SR)**



Sr. Pan-Tilt Head



AC Adapter



Joystick Controller with cap



Cable and XLR Cable



Universal Adapter



Accessories



Fasteners



1/4" Camera Mounting Screw



## Safety Hints

### **ATTENTION: PLEASE READ THE FOLLOWING CAUTIONARY POINTS BEFORE USING THE JIB TO PREVENT DAMAGE TO THE EQUIPMENT AND THE OPERATOR!**

- The crane may not be assembled or operated under the influence of alcohol, drugs, or any other intoxicating substances. Lack of attention while connecting the components can cause substantial damage to the equipment/operator.
- The crane may only be operated in a leveled horizontal position. Make sure that the surface is stable.
- To prevent any harm or injury, properly join all crane sections. In addition, using the support stand while telescoping the complete length is suggested.
- Always connect the steel cables properly to provide stability to the system. They should not negatively impact the movements of the crane in any way.
- After the crane is set up, the pan-tilt/gimbal head shall be positioned under the central pivot section. In the assembled state, when the pan-tilt head/gimbal head is higher than the central pivot section, there should be someone to look after the crane system.
- The complete panning & lifting range around it must be kept free. Avoid anybody standing under the crane. No loose objects may be stored or placed on it. Be very careful while using indoors.
- Never operate the crane near high-voltage power cables. It holds danger to life.
- Particular care is required when operating the crane in unfavorable weather conditions. The crane must be shut down in sufficient time. When used on a rainy day, the pan-tilt / gimbal head and controlling bar shall be protected against rain.
- When transporting the crane, lock the Pan & Tilt Axis for safety. Ensure the components do not rub together and cause any material wear.
- Before removing the counterweights, ensure the remote head rests on the support stand. Then, gradually remove the counterweights before the remote head, camera, or other parts.
- Avoid abruptly swiveling or stopping the crane in the interest of safe crane operation. Otherwise, it may cause serious damage to equipment.

FOLLOWING THESE GUIDELINES WILL PROVIDE BETTER SHOTS AND TROUBLE-FREE OPERATION. SHOULD YOU NEED ADDITIONAL INFORMATION, TECHNICAL ASSISTANCE IS AVAILABLE 'ONLINE' BY CONTACTING THE SALES REPRESENTATIVE.

# INDEX

Sr. No	Particulars	Page No.
1	D-33 Dolly Assembly	8
2	Tripod Holder Assembly	9
3	LW-150 Jib Stand Assembly	9-11
4	Hub Mounting	11-12
5	Jib Section Assembly	12-14
6	Section 7 & Section 6 Assembly	14-15
7	Head Platform Mounting	15-16
8	Turn Buckle Mounting	16
9	Levelling Cable Assembling	16-17
10	Joystick Controller Bracket Assembly	17
11	Weight Rod Assembly	18
12	Weight Mounting	18
13	Rear frame Mounting Rod	18
14	Sr. Pan-Tilt Head Mounting	21
15	Camera Mounting	21-22
16	12V Joystick Controller Assembly	22-23
17	Cable & XLR Cable Assembly	23
18	AC Adapter & Universal Adapter Assembling	23-25
19	Screen Mounting	25-26
20	Spin-3 Joystick Controller Mounting (Optional)	26-28
21	Shorting the length of Jib	28-31
22	Balancing	32
23	Balancing Tips	36

## Kite-22 Crane Popular Setup

### Kite-22 Crane Popular mounting on Dolly

#### D-33 Dolly Assembly

- Loosen the side bolt of the D-33 Pro Camera Dolly using the 17mm spanner.

**NOTE:** This dolly has various holes for flexible Tripod mounting.



- Remove the Bolt nut, washer and Bolt.



- Repeat the same steps to remove the second side Bolt of the D-33 Dolly.



- Stretch the legs of the D-33 Dolly and open it.



- After opening the Dolly, re- insert the Bolt, washer and Bolt nut.

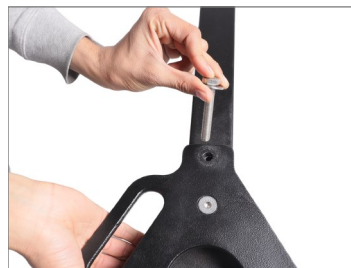



- Tighten the Bolt nut using the 17mm spanner.
- Repeat the same step to re-insert the second side Bolt.

**NOTE:** The centre bolt will not be removed to open the D-33 Dolly.



## Tripod Holders Assembly

- Remove the Allen bolt from the Tripod holder using a 3/16" T-Type Allen key and mount the holder on the Dolly.



- Carefully align the holes of the Tripod holder with the Dolly, insert an Allen bolt, and retighten it using a 3/16" T-Type Allen key.



- Repeat the same step to mount the remaining tripod holders.

**FEATURE:** The position of the Tripod Holder can be adjusted to accommodate the Tripod legs.

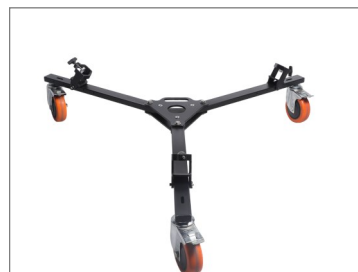

## LW-150 Jib Stand Assembly

- Stretch the legs of the LW-150 Jib Stand and open the Stand.



- Loosen the knob and extend the Tripod leg.

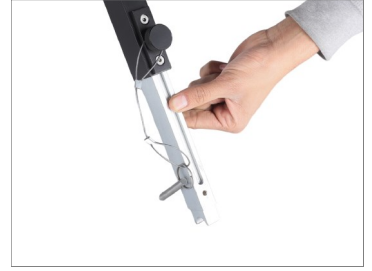

- Now, lock it using the locking pin once it is at the desired length.



- Tighten the knob.
- Repeat the same step for extending the remaining Tripod legs.



- Loosen the knob of the tripod holder and mount the Tripod Stand on the Dolly.



- Tighten the knob of all three Tripod legs after mounting the Tripod.



- Remove the pan friction knob and plastic washer from the Stand



- Remove the bolt on the base of the Tripod using the 21mm spanner.



- Repeat the same step to remove the second bolt.



## Hub Mounting Assembly

- Mount the Hub Mounting on the Tripod.

**NOTE:** The Hub Assembly has several mounting holes for attaching additional accessories like a LCD Monitor or a Joystick box.



- Now, re-insert the bolts and tighten them using the 21mm spanner.



- Re-insert the plastic washer and pan friction knob.
- Tighten the knob properly to secure the assembly hub.



- Hub Mounting is now securely mounted on the jib Stand.

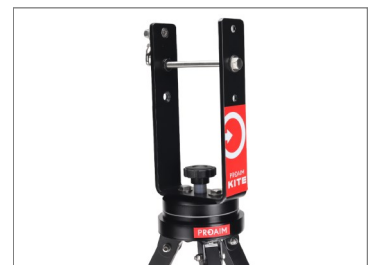

- Loosen the nut bolt using the 21mm spanner and remove the Hub mounting shank.



## Jib Section Assembly

- Insert the 2nd section into the 1st section and mount them on the Hub mounting by aligning the threads.



- Insert Shank into the Hub mounting ensuring the holes of the both sections are aligned with the holes of the Hub mounting.



- Now, re-insert the washer and nut bolt into the Shank of the hub mounting.



- Tighten the nut bolt using the 21mm Spanner.

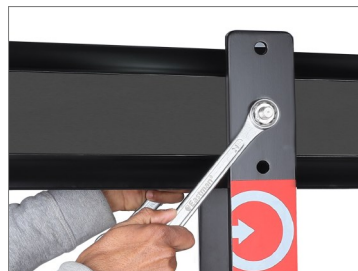

- Remove the black shank knob and plastic washer by loosening them.

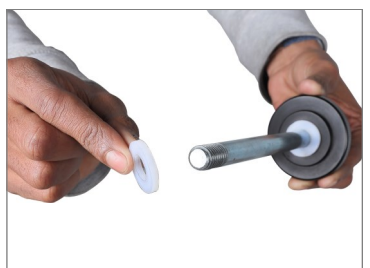

- Now, insert the Shank into second hole of the 1st Jib section, as shown in the image.



- Re-insert the plastic washer and knob from the other side.



- Tighten the knob using the 4mm T-Type Allen key.



- Insert 3rd section into the 2nd section by ensuring the holes are aligned.
- Insert the 4th, 5th & 6th section following the same steps.



- Insert the Shank in the section joint after ensuring alignment of the holes.



- Now, insert plastic washer and knob from the other side.



- Tighten the shank knob using the 4mm T-Type Allen key.



- Insert the locking pin into the 1st section from the top and lock it securely.



- Similarly, insert the locking pin into the 2nd section from the top and lock it securely.



- The 1st, 2nd and 3rd Section are securely attached.



- Repeat this process for attach the remaining sections.

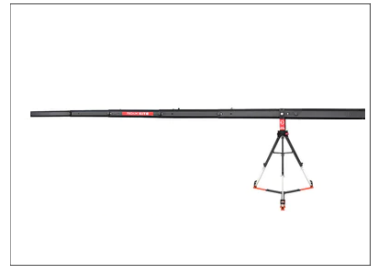

## Jib Section 7th & Section 6th Assembly

- Insert 7th section into the 6th section and insert the shank ensuring the holes are aligned.



- Insert plastic washer and knob from the other side and tighten the knob securely.



- 7th section is securely attached.

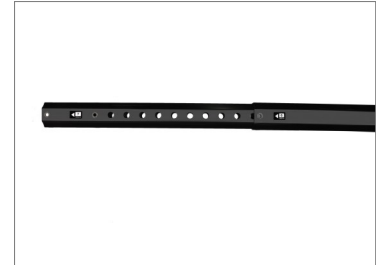

- Insert locking pin into the 6th section from the top and lock it securely.
- Attach 6th section with 5th, 5th section with 4th, 4th section with 3rd, 3rd section with 2nd and 2nd section with the 1st.



## Head Platform Mounting

- Loosen the bolt of the Head platform and remove it.
- Remove plastic washers, steel washers and shaft collars from the Shank.



- Mount Head Platform on the 7th section of the jib.



- Attach Head platform to the jib section.
- Now, insert the long bolt and plastic washer.

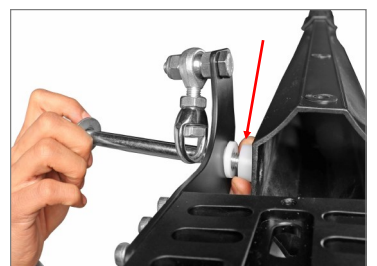

- Insert two Shaft collars inside the jib and insert plastic washer in the center of Jib and Head platform.

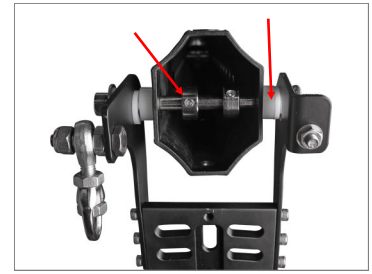
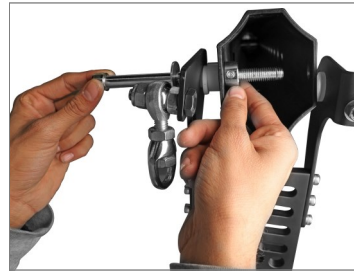

- Insert plastic washer and steel washer to the other side of the long bolt.



- After inserting washer, insert nut and tighten it using a 21mm spanner.
- To tighten the bolt, tighten the other side of the long bolt using the 10mm Allen key and then tighten the other side using the 21mm spanner.



- Now, move both the Shaft collars to the sides and tighten them using a 3mm T-Type Allen key.



## Turn Buckle Mounting

- Attach Turn Buckle to the Hub mounting.



## Leveling Cable Assembly

- Attach one end of the levelling cable to the Hub mounting.





- Insert the other end of the Leveling cable into the Turn Buckle and lock the cable.

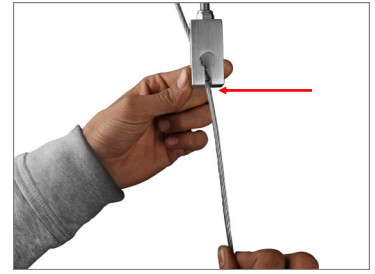

- Stretch the levelling cable per your requirement.



## Joystick Controller Bracket Assembly

- Attach the Joystick Controller Bracket to the Jib and insert the Shank.



- Now, insert the washer and nut bolt to the other side of the Joystick Controller .



- Tighten the nut bolt using the 21mm Spanner.
- Joystick Controller Bracket is now attached to the Jib.



## Weight Rod Assembly

- Insert the Weight rod into Joystick Controller Bracket.
- Now, insert the black tube to the center.



- Using the same step insert the black tubes to the weight rod on both sides, as shown in the image.



## Weight Mounting

- Put weights on the weight rods as per your requirement.



- Now, put stoppers to secure the weights.



## Rear Frame Mounting Rod

- Insert Rear Frame Mounting Rod into the Joystick Controller Bracket and tighten them securely.

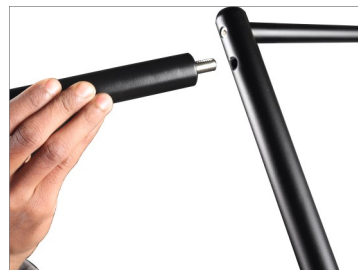

- The Jib is securely mounted on the Jib stand.



## Kite-22 Crane Starter mounting on Dolly



# Parts of Sr. Pan-Tilt Head

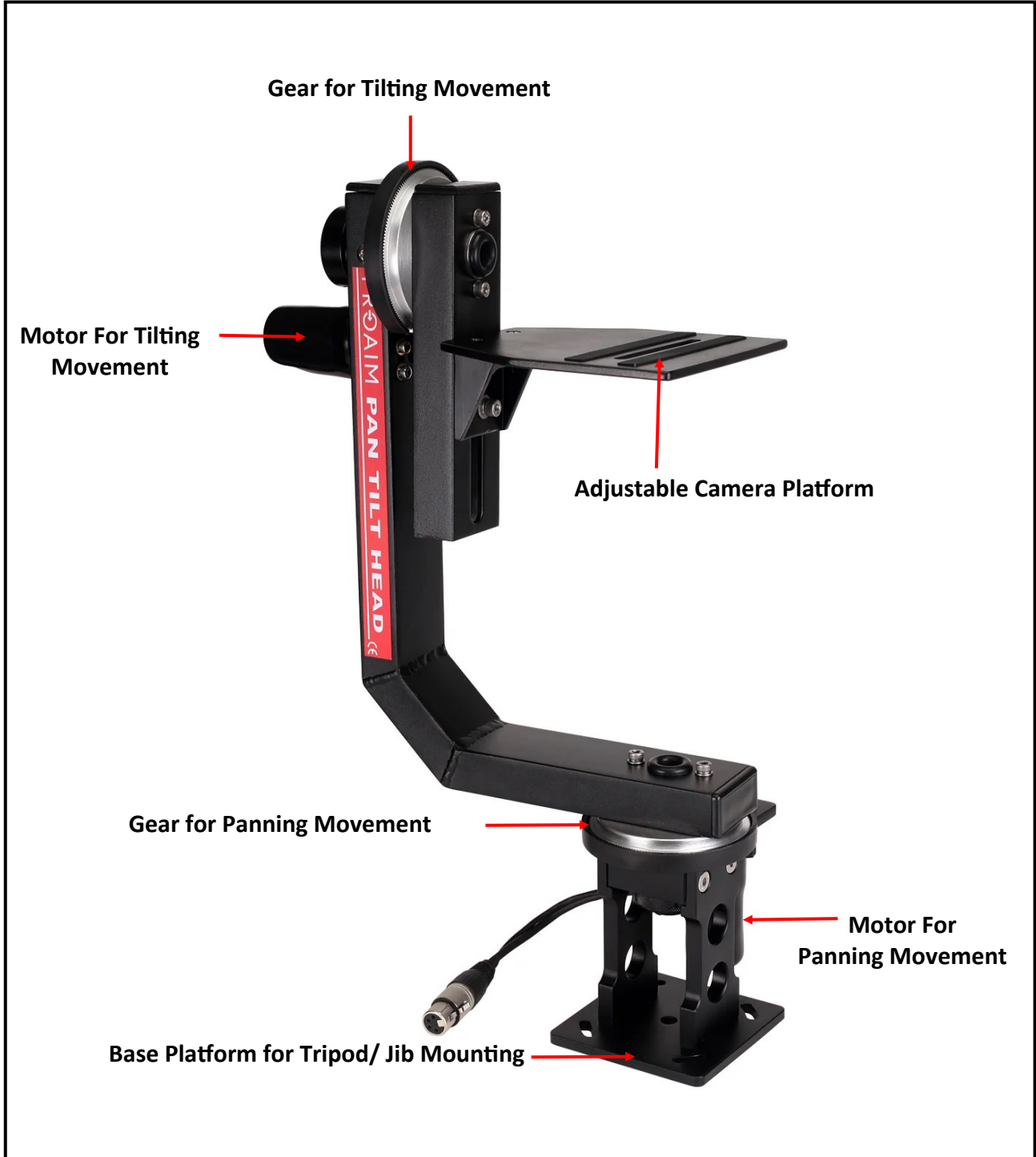

## Sr. Pan Tilt Head Mounting

- Attach Sr. Pan-tilt Head to the Head Platform and insert the bolt.

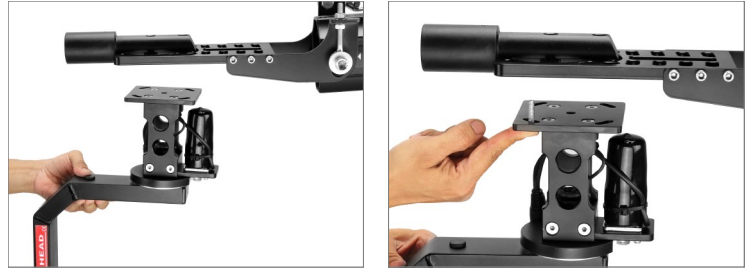

- Now, insert the fastener and secure it.



- Sr. Pan-tilt Head is securely attached to the Head Platform.



## Camera Mounting

- Mount the Camera (Not Included) on the camera plate and insert the bolt.



- Tighten the bolt using the 3/16" L-type Allen Key.



- To set the position of the Camera plate, loosen or tighten its bolt using the 3/16" Allen key.

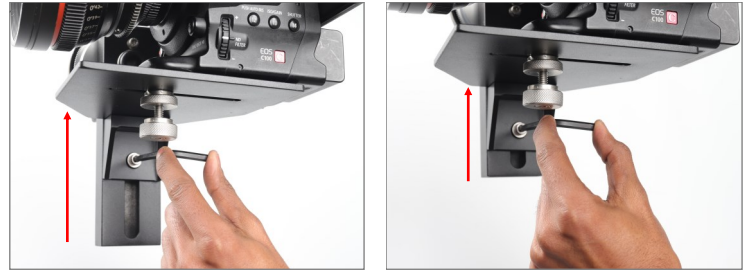

- The camera is securely mounted.



## 12V-Joystick Controller Assembly

- Remove Velcro from the top and bottom of the Joystick controller Bracket.



- Remove the pasting from the Velcro.

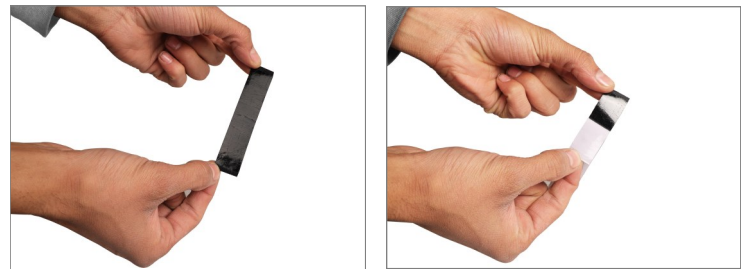

- Paste the Velcro on the top, back, and bottom of the Joystick.

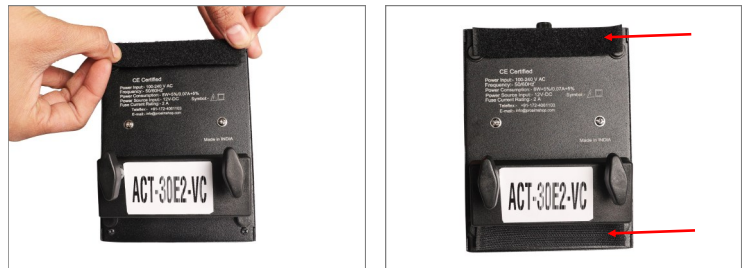

- Attach the Joystick Controller to the Joystick Controller bracket ensuring the Velcro matches.



- Adjust the position of the Joystick controller at 90°.



## Cable & XLR Cable Assembly

- Connect the female end of the Pan-tilt cable to the male end of the XLR cable.



- Attach the cable's female end to the Joystick controller.



- Attach the AC Adapter's female end to the Joystick controller.



## AC Adapter & Universal Adapter Assembly

**CAUTION:** Do not use an unregulated power supply.

- A regulated power supply must produce less than 24 volts.
- We do not recommend for using it at 24 volts or more than 24 volts as it may cause permanent damage.

- Attach the Power cable's one end to the remote controller.



- Attach the Power cable's other end to the Universal adapter.



## Parts of Joystick Controller

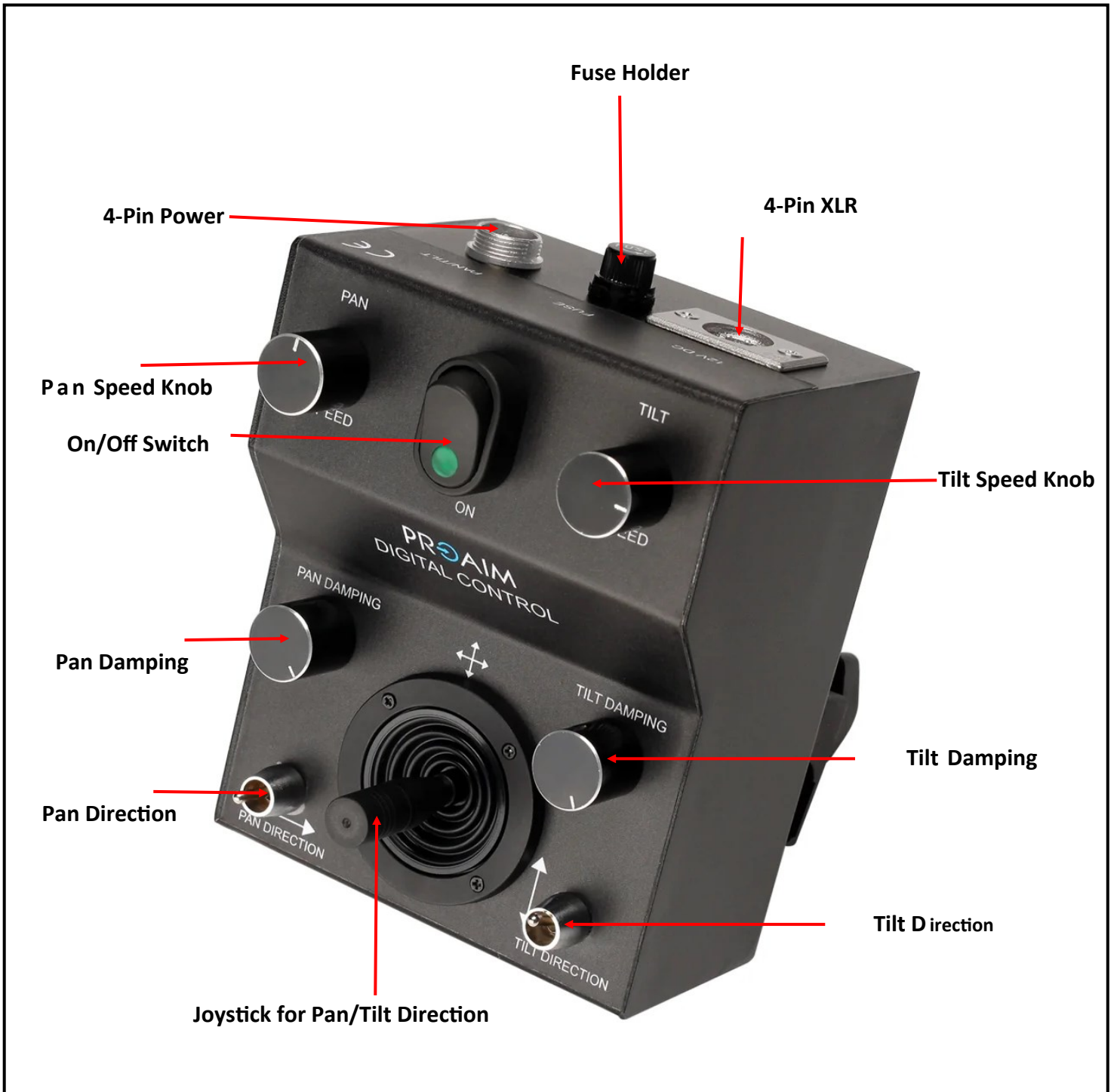



- **Speed Controller** adjusts the pan/tilt speed based on the requirement of the shot.
- **Damping control** prevents the Head from stopping with a jerk enabling you to achieve smooth endings.
- You can reverse the **pan & tilt direction** per your requirement.



- Turn "ON" the Joystick controller.



- Adjust the speed of the Pan & Tilt per your requirement.



- Adjust the damping of the Pan & Tilt per your requirement.



## Screen Mounting

- Remove the Base-100 and mount the Screen **(Not Included)**.



- After mounting the screen use a screwdriver (Not Included) to tighten its bolt.

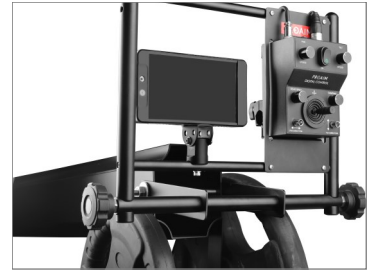

- Loosen or tighten the bolt using a 4mm Allen key to adjust the positioning of the screen.



## Spin-3 Joystick Controller Mounting (Optional)

- Remove all the bolts using a screwdriver.



- Now, remove the plate from the Joystick controller.



- Attach Spin-3 joystick plate aligning the holes.

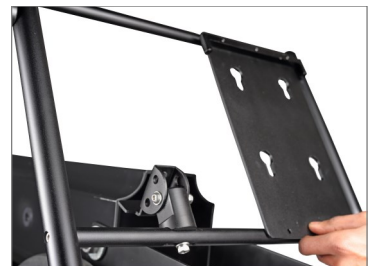

- Insert the bolt after aligning the holes and then tighten it using a screwdriver.

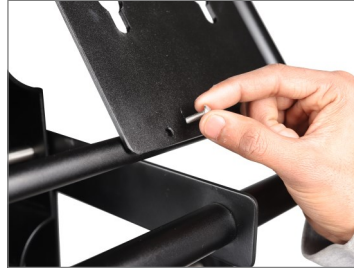

- Repeat the same step to insert the remaining bolts.



- Attach the Spin-3 Joystick controller and lock it securely.



- **Speed Controller**

The Speed Controller adjusts the speed of pan tilt & Dutch roll based on the requirement of the shot.

- **Dead Spot**

The dead spot prevents the head from stopping suddenly with a jerk.

- **Damping Control**

Damping control prevents the Head from stopping with a jerk enabling you to achieve smooth endings.

- **Pan-Tilt Roll Direction**

You can reverse the panning & tilting direction as & when required.



# Parts of Spin-3 X Joystick Controller



## Shorting the Length of Jib

- To shorten the length of the Kite crane remove the Levelling cable from the Shank of the Hub section.



- Remove both locking pins from the 1st Section.



- Loosen and remove the knob of the shank using a 4mm T-Type Allen key.



- Now, remove the shank.



- Remove the nut bolt of the Hub section's shank using the 21mm spanner and remove the shank, as shown in the image.



- Slide 2nd Section into 1st Section and insert the shank.
- Now, align the second hole of section 2 with the first hole of section 1 and insert the shank.



- Insert the nut bolt from the other side and tighten them using the 21mm spanner.



- Slide 3rd section into 2nd section and repeat the same step to insert the shank.

**NOTE:** Make sure to align the holes of both sections.



- 2nd Section is now securely attached to 3rd section .
- Repeat the same steps to insert Shank with knobs and locking pins.



**NOTE:** To shorten the length of the jib, insert 2nd section into 1st section , 3rd section into section, 4th section into 3rd section, 5th Section into 4th section, 6th section into 5th section, and 7th section into 6th section.



## Different Shooting lengths



## Balancing

**Follow these steps to balance the head:-**

- Find the horizontal balance point of your camera while holding the handle.
- Mark this point on the side of the camera with chalk or tape.
- Turn the unit on and move the tilt control until the camera plate is vertical.
- Loosen the two screws holding the tilt motor. **(DO NOT REMOVE)**
- Grasp the motor and turn slightly to disengage the gears.
- Mount the camera to the camera plate with the screw provided.
- Tighten by securely threading the nut up to the bottom of the camera plate.
- Ensure your balance point, previously marked with chalk or tape, is in the middle of the plate.
- Loosen the knob below the camera plate and slide the camera and plate up or down until the center line of your camera is about in the middle of the large gear. Now tighten the knob.
- If the camera is perfectly balanced, it stays in any position while motor gear remains unattached.
- Grasp the motor and turn it back until the gears mesh.
- Gently tighten motor screws.
- Secure the camera.

**Note:** All reduction boxes have a small amount of backlash. The balancing of the camera will reduce the backlash to a minimum, making it feel like it is at the top of the tilted arc.

### **OPERATION**

- With the camera set up as described above, Power ON by pressing the RED Switch on the top of the Joystick control box.
- For inverted use, disconnect the leads to the motors, rotate the control box 180 degrees, and re-install.



## PROAIM Sr. PAN TILT HEAD

The PROAIM™ Sr. PAN TILT HEAD circuitry is built entirely into joystick box. The only other requirement is the AC power pack (provided) or battery power. The power pack can handle 90-240 volts. Users will need the appropriate plug adapter for local use.

## JOYSTICK

The joystick is a two-axis variable speed servo controller. The further you move in one direction the faster the output to that motor. This will be a little tricky at first, but little practice will improve your success.

The joystick may be operated in a handheld position or from a flat surface such as a tabletop, or attached to the boom arm of Jib.

After plugging the power cord into a proper outlet, press 'power on, the LED light on the control box should illuminate, and the head may jump slightly on start-up or shut down. This is normal. Dead Spot can control this. Next, adjust the joystick to ensure correct movement of the head. It may be necessary to reconnect to the motors if required.



## **TILT DIRECTION SWITCH**

When the head shifts from a Jib to a tripod or vice versa, it needs a reversal of direction as the location of the head will be inverted. By switching "on" the tilt direction switch, we can immediately reverse the direction. When the joystick is moved up, it gives up rotation while mounted on the tripod directly.

## **POWER CONTROL**

To the right and above the joystick is a knob labeled "SPEED".

This is power control knob. Turning to the right will increase the speed and back to the left will decrease the pan and tilt operation speed. The advantage of power control is to limit power when only slow accurate movements are needed. With the power control at half power (approx. 8 volts max. output), the full range of motion on the joystick will be between 0 and 8 volts making finer adjustments possible. The power control will be usable between a range of approximately 4 volts to 12 volts.

## **DEAD SPOT**

The knob to the left is marked Dead Spot. Turned to the left (counterclockwise) will create a minor dead spot, which means that the head will begin to move as soon as the smallest deflection of the joystick is made. Moving to the right will increase the area where no power is sent to the head motors. At halfway, the dead spot will close again; this helps avoid crossing the tilt when only pan movement is desired.

The dead spot is so tight when the control knob is to the left; it may be necessary to back it off slightly until no movement is seen in either axis.

**NOTE:** With the Dead Spot all the way left the head may move in both axis on its own. The Dead Spot should be set at approx. The 9:00 position to ensure that no unwanted movement occurs.

## **PAN DIRECTION SWITCH**

### **When the Pan-Tilt Head is used on a Tripod or on a Jib.**

When the head is shifted from a Jib to a tripod or vice versa, it needs a reversal of direction as the location of the head will be inverted. By switching "on" the pan direction switch, we can immediately reverse the direction. When the joystick is moved to the right, it gives the right rotation while mounted on the tripod directly.

## **Linear or Logarithmic taper joystick control**

All joysticks are linear, meaning that each degree of movement of the stick correlates to the output. On the 12-volt PROAIM SR.PAN-TILT HEAD half deflection of the joystick indicates approximately 6 volts sent to the motors. But with the advent of Digital, we can now control the taper of the joystick, making it Logarithmic. Logarithmic taper is that the first joystick movement only sends a small amount of power to the motors. The last of the deflection will send more energy per degree of deflection. On Logarithmic taper, 1/3 of joystick deflection might yield 2 volts output; the next 1/3 will produce 4 volts output and the last 1/3 yields 6 volts for a maximum of 12 volts. This mode gives the operator fine slow movements yet retains the ability to go maximum speed if necessary.

## **DAMPING KNOB**

Damping is the ability to control the "damping" effect of the joystick interface with the pan/tilt action being controlled. It does not matter what head you are using; the damping effect is a characteristic of the joystick output.

## Balancing Tips

The sections collapse into each other

### 1. 24.5' Jib

Weights required for balancing only Jib (without camera & Pan Tilt) is: **55Kg (121.5 lbs)**

**If the camera weight is 1kg, the jib is balanced with  $55+5\text{kg}=60\text{kg}$**

**If the camera weight is 2kg the jib is balanced with  $55+10\text{kg}=65\text{kg}$**

### 2. 22.3' Jib

Weights required for balancing only Jib (without camera & Pan Tilt) is: **54Kg (119 lbs)**

**If the camera weight is 1kg, the jib is balanced with  $54+4\text{kg}=58\text{kg}$**

**If the camera weight is 2kg the jib is balanced with  $54+8\text{kg}=62\text{kg}$**

### 3. 19' Jib

Weights required for balancing only Jib (without camera & Pan Tilt) is: **53Kg (116 lbs)**

**If the camera weight is 1kg, the jib is balanced with  $53+3\text{kg}=56\text{kg}$**

**If the camera weight is 2kg the jib is balanced with  $53+6\text{kg}=59\text{kg}$**

### 4. 15.10' Jib

Weights required for balancing only Jib (without camera & Pan Tilt) is: **52 Kg (114 lbs)**

**If the camera weight is 1kg, the jib is balanced with  $52+2\text{kg}=54\text{kg}$**

**If the camera weight is 2kg the jib is balanced with  $52+4\text{kg}=58\text{kg}$**

### 5. 12.8 ' Jib

Weights required for balancing only Jib (without camera & Pan Tilt) is: **51 Kg (112 lbs)**

**If the camera weight is 1kg, the jib is balanced with  $51+1\text{kg}=52\text{kg}$**

**If the camera weight is 2kg the jib is balanced with  $51+2\text{kg}=53\text{kg}$**

### **For some interesting compound shots try:**

Moving the pan & tilt control in the same direction as you move the rear of the jib. This keeps your subject framed but changes the perspective of the camera.

**YOUR PROAIM KITE-22 CAMERA CRANE POPULAR PACKAGE  
ALL DRESSED UP AND READY TO GO!**



**(SHOWN WITH OPTIONAL ACCESSORIES)**

**Warranty:** We offer one year warranty for our products from date of purchase. Within this period of time, we will repair it without charge for labor or parts. Warranty doesn't cover transportation costs nor does it cover a product subjected to misuse or accidental damage. Warranty repairs are subjected to inspection and evaluation by us.

**Liability:** We are not liable for damage caused by products that we do not supply or from mishandling in transit, accident, misuse, neglect, lack of care of the product, or service by anyone other than our company.

**Contact Us:** In case of any kind of dissatisfaction, please Contact us immediately and we promise our utmost support and care until you use our product.