

Assembly Manual

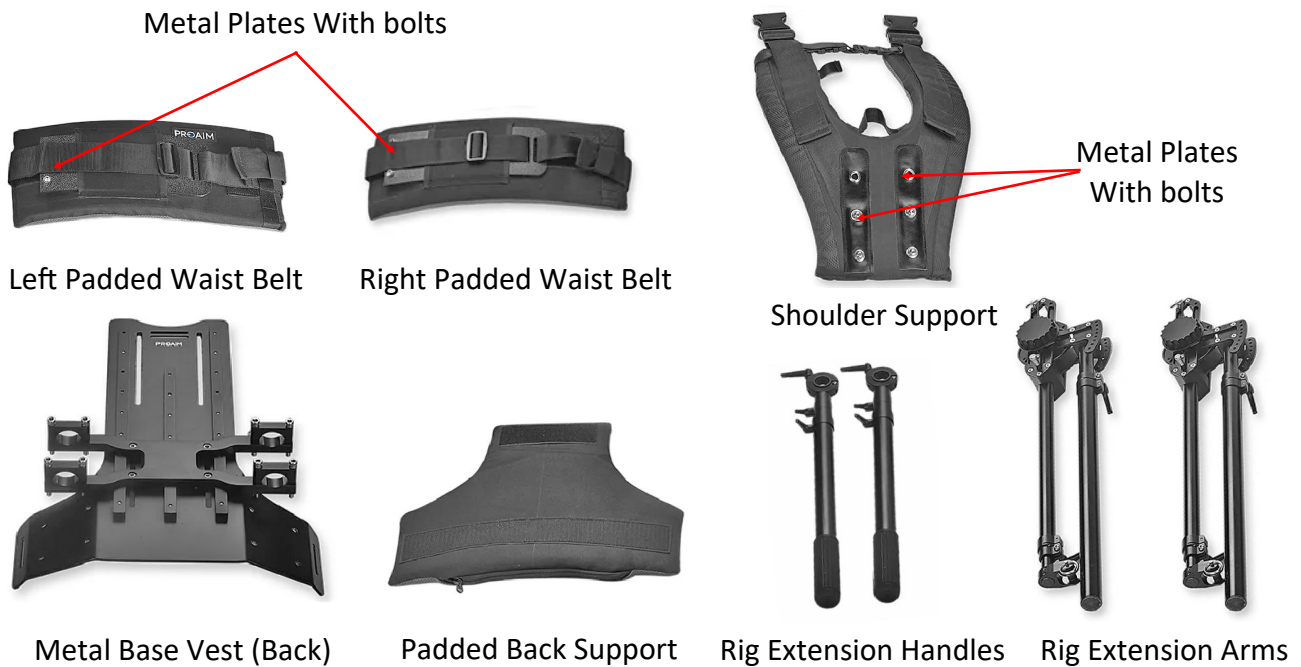

What's In The Box

Please inspect the contents of your shipped package to ensure you have received everything that is listed below.



All rights reserved.

No part of this document may be reproduced, stored in a retrieval system, or transmitted by any form or by any means, electronic, mechanical, photo-copying, recording, or otherwise, except as may be expressly permitted by the applicable copyright statutes or in writing by the Publisher.



Padded Rig Elastic with Hook
(Sizes: 9mm,10.6mm,13mm)



Rig Top Bar



Gimbal Adapters



2 x Net Pouches



8 x Small Pouches



4 X T-Type Allen Keys
(Sizes: 2.5mm, 3mm,4mm,5mm)



Bag Packing

INDEX

Sr. No	Particulars	Page No.
1	Left/ Right Padded Waist Assembly	4
2	Metal Base Vest (Back)	4
3	Shoulder Support Assembly	5
4	Shoulder Support Height Adjustment	5
5	Padded Back Support Mounting	6
6	Rig Extension Arms Assembly	6-7
7	Rig Elastic Mounting	7-8
8	Rig Elastic Adjustment	9
9	Rig Extension Arms Length Adjustment	10
10	Rig Top Bar Mounting	10-11
11	Rig Extension Handles Assembly	11
12	Camera Mounting	12-13
13	Star Ring Setup	14
14	Gimbal Adapters Assembly	14
15	Final Setup	14

Hawk Pro Body Support Setup

Left/ Right Padded Waist Belt Assembly

- Loosen both bolts of the Left padded waist belt and remove them using the 4mm Allen key.



- Now, carefully remove the metal plate and keep it aside.



Metal Base Vest (Back) Assembly

- Place the metal plate beneath the plastic plate ensuring the holes are aligned.

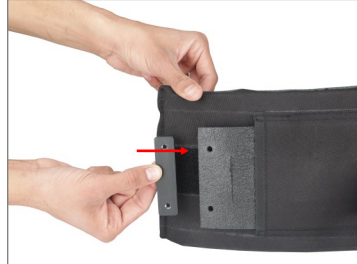

- Now, attach the Left Padded Waist belt to the Metal Base Vest.

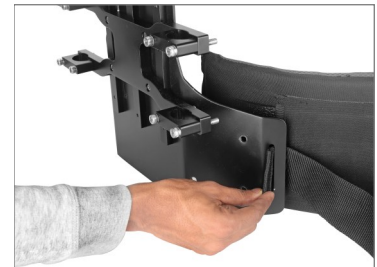

- Insert the bolts.
- Re-tighten the bolts using the 4mm Allen key.

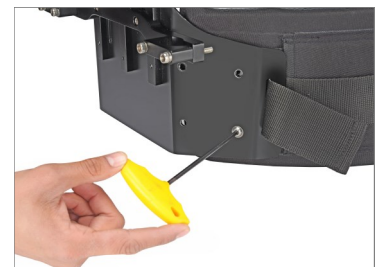

- Insert the belt strap into the buckle and adjust accordingly.
- Follow the same process to attach the Right padded waist belt to the metal base vest.



Shoulder Support Assembly

- Loosen and remove all the bolts of the shoulder support using the 4mm Allen key.



- Now, place the metal base plate on the shoulder support ensuring the holes alignment.
- Then insert the bolts.



- Re-tighten all the bolts using the 4mm Allen key.



Shoulder Support Height Adjustment

- To make the shoulder support a little higher, carefully place the metal base plate on the middle holes of the shoulder support.
- Then, insert the bolts ensuring the holes alignment.

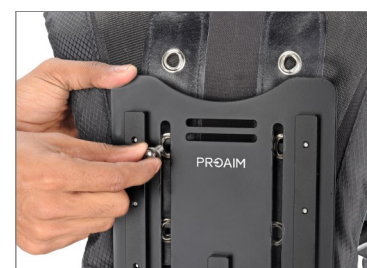

- Re-tighten the bolts using the 4mm Allen key.



Padded Back Support Mounting

- Attach the padded back support to the jacket.



- Padded back support is securely attached to the jacket.

NOTE: The Padded back support comes with a Velcro attachment for quick mounting.



Rig Extension Arms Assembly

- Remove the locking pin from the Rig extension arm.

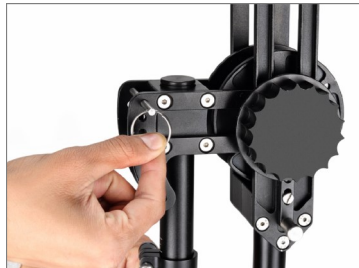

- Now, open the Rig Extension Arm and adjust its position.



- Once the arm is at the desired position, insert the Locking pin to secure it.

- Loosen all the bolts of the metal base plate clamp using the 5mm Allen key.

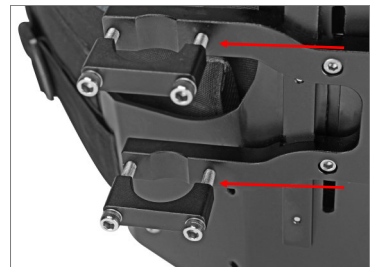

- Insert the Rig extension arm into the clamp.
- Then re-tighten all the bolts of the clamp using the 5mm Allen key to secure it.



- Follow the same steps to attach the second Rig extension arm.

FEATURE: You can adjust the position of the Rig Extension Arm as per your requirement.



Rig Elastic Mounting

- Insert Rig Elastic into the Rig extension arm from the bottom and move it across.



- Carefully place the Rig Elastic on the provided Slot to secure it.



- Remove the locking pin and pulley from the Rig extension arm.



- Mount the Rig Elastic on the pulley.
- Then carefully mount the pulley on the Rig extension arm and insert the locking pin securely.



- Follow the same steps to mount the Rig elastic on the other Rig extension arm.



Different Sizes Of Rig Elastic with Payload



Rig Elastic Adjustment

- Rotate the knob clockwise to tighten the Rig elastic.
- Press the locking pin and rotate the knob anti-clockwise to loosen the Rig elastic.

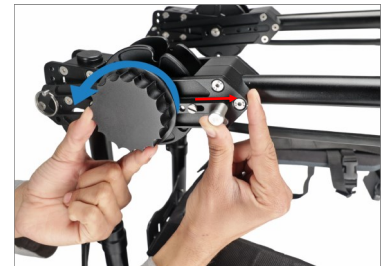

- Rig Elastic is securely mounted on the Rig Extension arms.

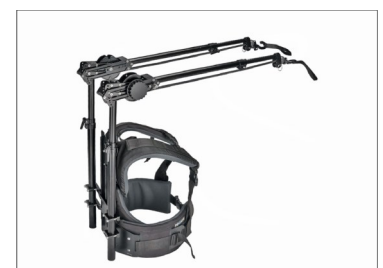

- Loosen the ratchet knob of the Rig Extension Arm and pull the rod outwards to increase the height.

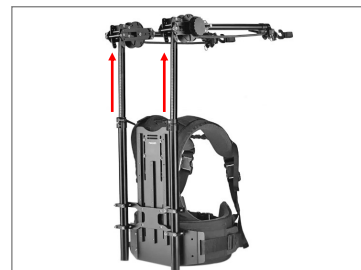

- Once it is at the desired height, re-tighten the ratchet knob to secure it.
- Follow the same process to increase the height of the other Rig Extension Arm.



Adjustable Back Support

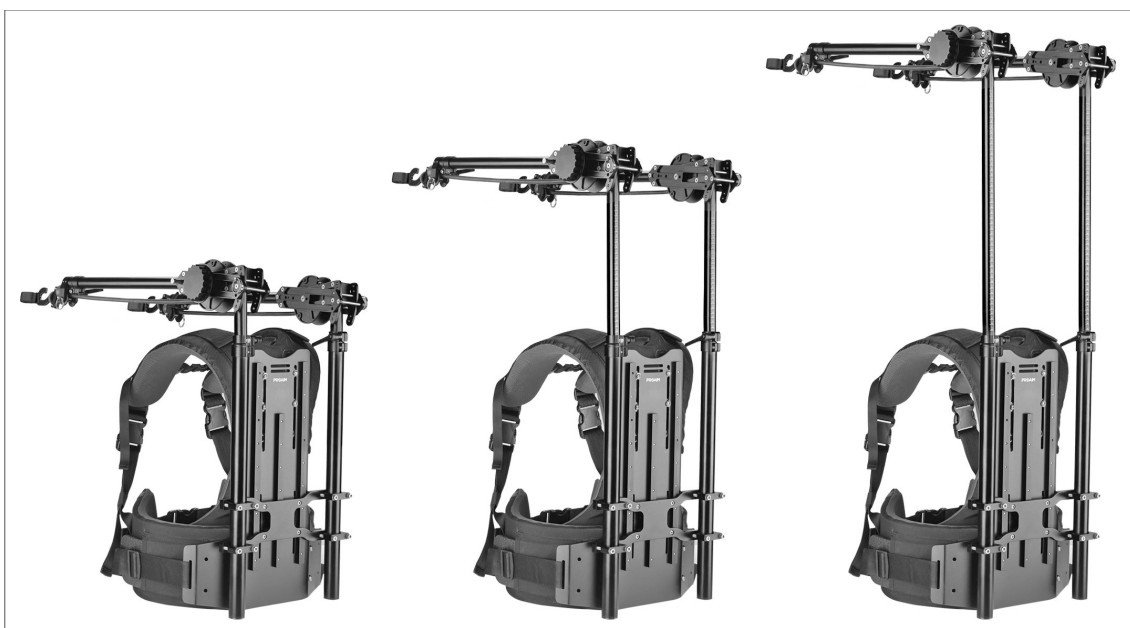

Rig Extension Arms length Adjustment

- Loosen the Ratchet knob of the Rig Extension Arm.
- Then extend the extension arm as desired and re-tighten the ratchet knob to secure it.

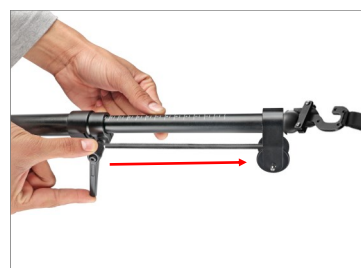

Adjustable Extension Arms



Rig Top Bar Mounting

- Loosen and remove the Allen bolts from the DJI Quick release (Not included) using the 4mm Allen key.
- Now, mount the DJI Quick release on the Rig Top Bar.
- Then insert both the Allen bolts.
- Re-tighten the Allen bolts using the 4mm Allen key.

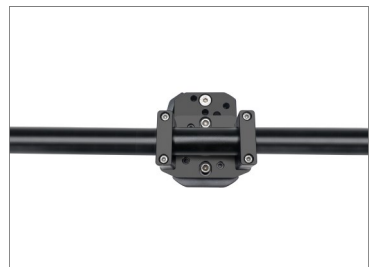

Rig Extension Handles Assembly

- Unscrew and remove the Ratchet knob from the Rig Extension Handle.



- Now, open the clamp of the Rig Extension Handle and remove the bush.

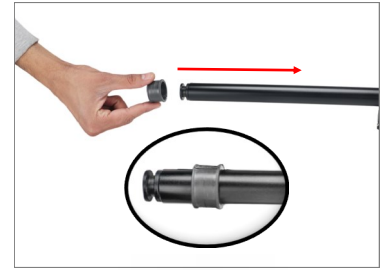

- Then, insert the bush on the Rig Top bar.

- Place the Rig Extension Handle clamp on the bush.



- Then, insert the Ratchet knob and tighten it.



- Follow the same process to mount the other Rig Extension Handle on the Rig top bar.

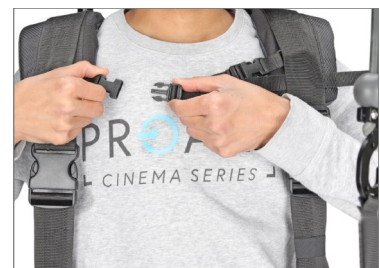

- Wear the Hawk Pro jacket and tighten the buckles provided at the waist and the chest.

- Then, adjust the jacket as per your convenience.



- Mount the Rig Top Bar on the Rig Extension Arm hooks.



- Loosen the top and bottom knob of the Rig Extension Handle.



- Now, extend the Rig Extension Handle as per your requirement.
- Then, re-tighten both the knobs to secure it.
- Repeat the same process for the second Rig Extension Handle.



Camera Mounting

- Slide the DJI Ronin 2 (Not Included) on the Quick release plate and secure it using the locking lever.



- Now, slide the Camera (Not Included) on the DJI Ronin 2.
- Secure the setup using the locking lever.



- The Camera is now securely mounted to the DJI Ronin 2 gimbal.

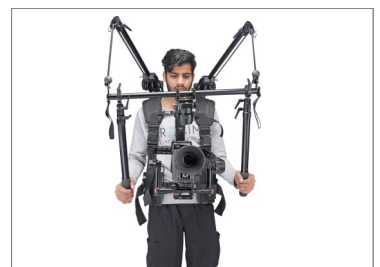

Different Shooting Angles



■ Star Ring Setup

Gimbal Adapters Assembly

- Loosen and remove all the bolts from the Gimbal adapter using the 3mm Allen key.
- Then, open the gimbal adapter.
- Attach the gimbal adapter to the Star Ring **(Not Included)** handle.
- Then, insert the bolts.
- Re-tighten all the bolts using the 3mm Allen key.



- Now, attach the Rig Extension Arm hook to the adapter.
- Follow the same process to attach the Rig Extension Arm hook to the other Gimbal adapter.



- Your setup is ready to use.

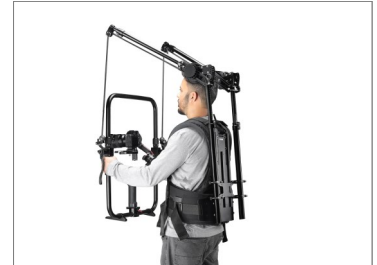

**YOUR PROAIM HAWK PRO BODY SUPPORT SYSTEM
ALL DRESSED UP AND READY TO GO!**



(SHOWN WITH OPTIONAL ACCESSORIES)

Warranty: We offer a one-year warranty for our products from the date of purchase. Within this period, we will repair it without charge for labor or parts. The warranty doesn't cover transportation costs, nor does it cover a product subjected to misuse or accidental damage. Warranty repairs are subject to inspection and evaluation by us.

Liability: We are not liable for damage caused by products we do not supply or from mishandling in transit, accident, misuse, neglect, or lack of care of the product or service by anyone other than our company.

Contact Us: If you are dissatisfied, please contact us immediately. We promise our utmost support and care until you use our product.