

Foldable Camera Platform Dolly (DL-FLDB-01)

Assembly Manual



What's In The Box

Please inspect the contents of your shipped package to ensure you have received everything that is listed below.



All rights reserved.

No part of this document may be reproduced, stored in a retrieval system, or transmitted by any form or by any means, electronic, mechanical, photo-copying, recording, or otherwise, except as may be expressly permitted by the applicable copyright statutes or in writing by the Publisher.

Functions

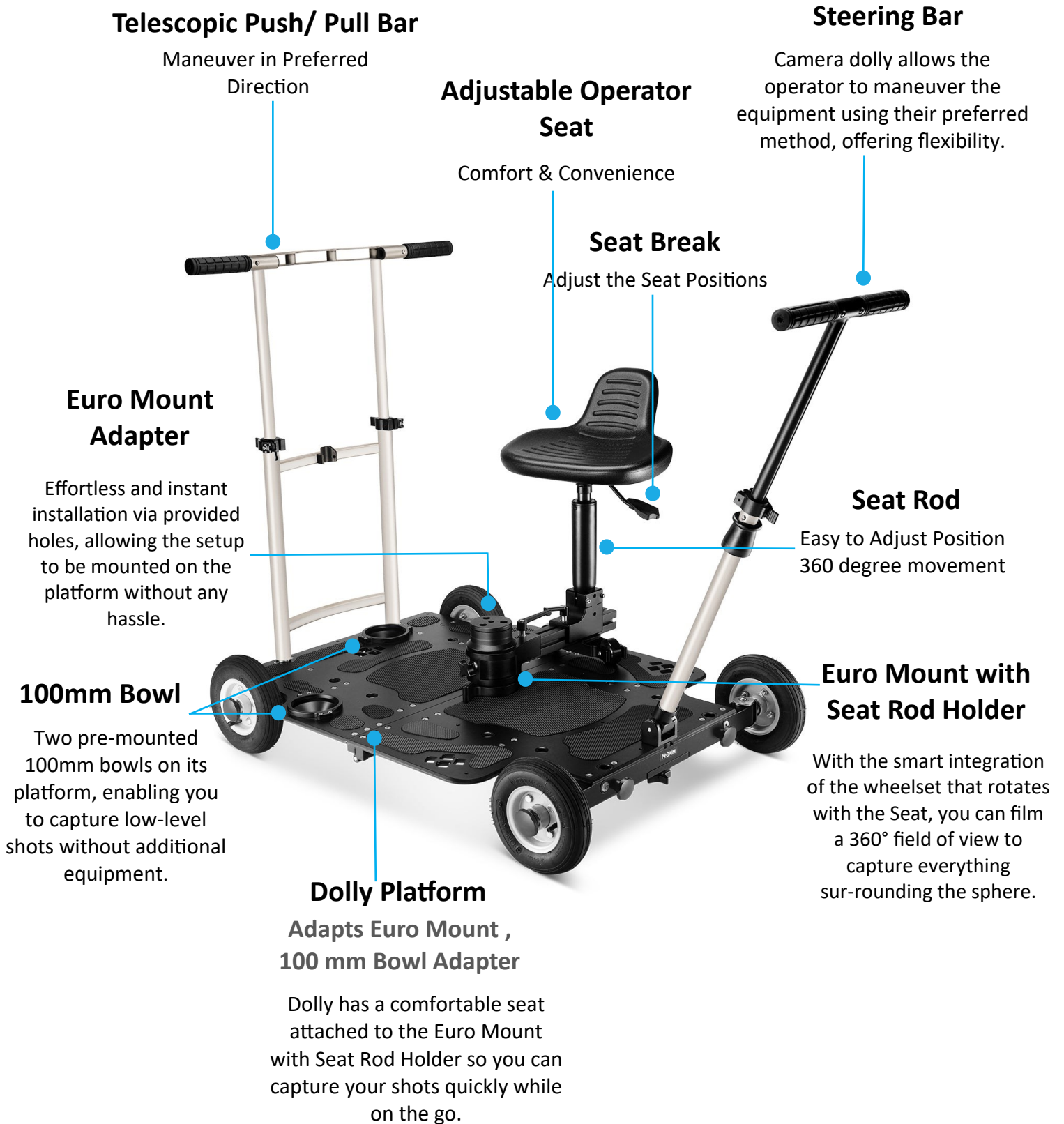

Foldable Platform Dolly Setup

- As the Foldable Dolly is collapsed for packaging, open the Dolly by pulling it as shown in the image.



- The Foldable Dolly is fully open.
Feature: Dolly can be neatly folded and stowed away in a single package. The Dolly features two pre-mounted 100mm bowls on its platform, enabling you to capture low-level shots without additional equipment.



100mm Bowls

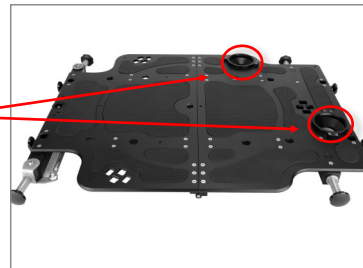

Collapsible Design

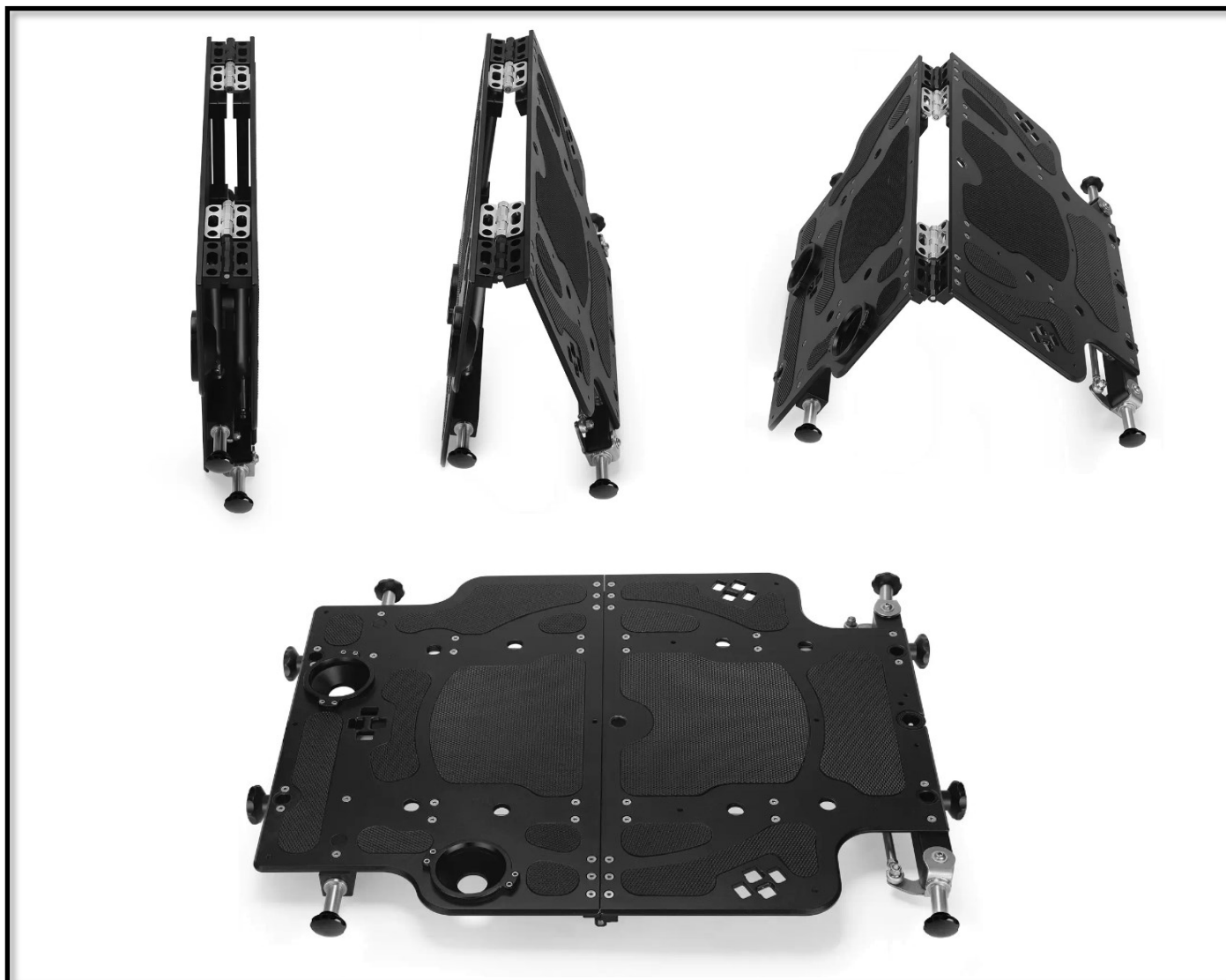

Pneumatic Wheels Setup

- Loosen and remove the knob of the Foldable Dolly.
- Loosen and remove all four knobs of the Dolly and insert Pneumatic Wheels, as shown in the image.
- After attaching the Wheels, properly secure them by re-inserting and tightening the knobs for a secure attachment between the wheels and the Foldable Dolly.
- The Pneumatic Wheels are fully secured with the Floor Dolly, as shown in the image.



Euro Mount Adapter Setup

- Mount the Euro Mount Adapter on the Foldable Dolly by matching the holes on the platform.



Feature: A robust Euro Mount Adapter is also included for an effortless and instant installation via provided holes, allowing the setup to be mounted on the platform without any hassle.

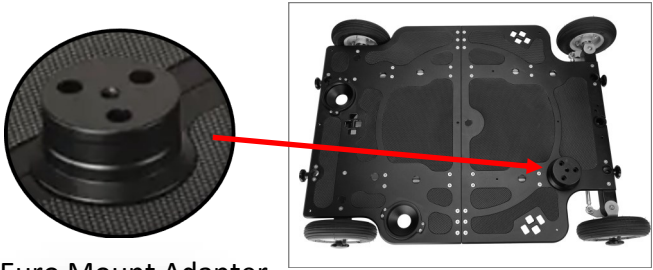

Euro Mount Adapter

Euro Mount Adapter Compatibility with provided holes



Seat Rod Holder Setup

- Mount the Euro Mount with Seat Rod on the Foldable Dolly.



- After mounting the Seat Rod, secure it using the knob, as shown in the image.



360° Rotatable Wheels Setup

- Loosen bolts of the Rotatable Wheels using the Allen key to allow movement of the Wheels.



- Loosen the ratchet knob of the Euro Mount Seat Rod holder and insert 360° Rotatable wheels in it.



- After inserting the Rotatable wheels, secure them using the ratchet knob.



- The Rotatable wheels are attached to the Euro mount with a Seat rod, as shown in the image.

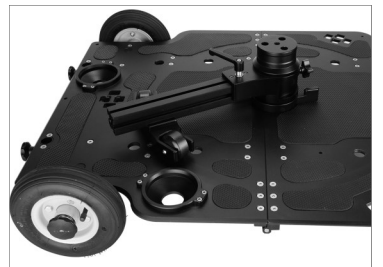

Seat Rod Setup

- Loosen the ratchet knob of the Seat Rod and attach 360° Rotatable Wheels with it.



- After attaching the Rotatable wheels, secure the setup using the ratchet knob as shown in the image.



Feature: The Camera Dolly has a comfortable seat attached to the Euro Mount with Seat Rod Holder so you can capture your shots quickly while on the go.



- The Seat Rod has features such as height adjustment and Seat brake so you can easily set your Seat up/down and lock the Seat's position



- The Seat is telescopic, allowing height adjustment with a simple lever mechanism.

Feature: With the smart integration of the wheelset that rotates with the Seat, you can film a 360° field of view to capture everything surrounding the sphere.



Capture 360° Field of View Revolving Wheel Set



Push/Pull Bar Assembly

- Pull the knob of the Foldable Dolly to mount the Push/Pull Bar.



- Insert the Push/Pull Bar on the provided holes of the Dolly platform.



- After inserting the Push/Pull Bar, properly secure it using the knob.

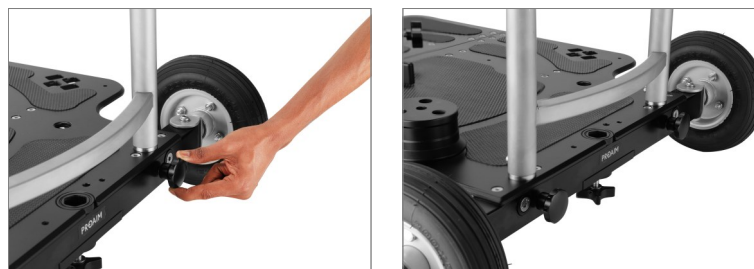

Telescopic Push/Pull Bar



Steering Bar Assembly

- Insert the Steering Bar by slightly loosening the knob.



- To extend the length of the Steering Bar, unlock its ratchet lever and pull the Bar upwards.



- Unlock the ratchet lever of the Push/ Pull Bar and push the Bar upwards.

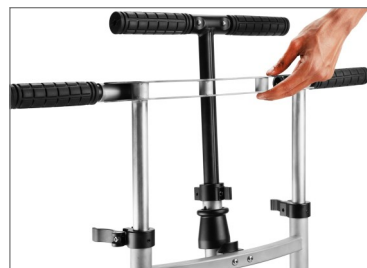
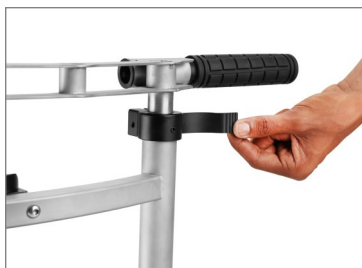

- After positioning the Push/ Pull Bar according to your requirement, secure it by locking the ratchet lever.



- To stabilize the movement/direction of the Steering Bar, lock it with the push/ Pull Bar as shown in the image.



- Press the push pin button and stretch out the Handle for movement of the handle, as shown in the image.

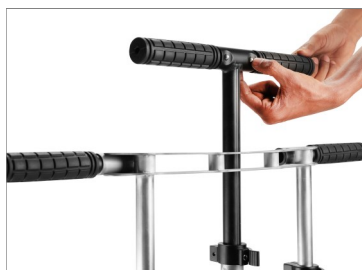

- Repeat the same process with the second Handle.
- To set the Handle in its previous position, stretch it sideways and lock it.

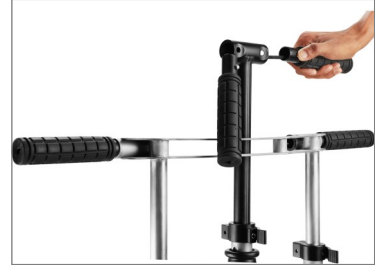

- The Handle is back in its position, as shown in the image.



- A similar procedure has to be followed for movement of the Push/Pull Bar's Handle press the push pin button and stretch out the Handle sideways.



- To set the Handle in its previous position, stretch out the Handle sideways and lock it.



- The Push/ Pull Bar and Steering Bar Handle movement can be done per your requirement.



Feature: By incorporating Steering Bar and Push Bar, the camera dolly allows the operator to maneuver the equipment using their preferred method, offering flexibility.



Pneumatic wheels movement through Handle



Telescopic Steering Bar



Bazooka (Not Included) Setup

- Mount the Bazooka (Not Included) on the Euro Adapter, as shown in the image.

NOTE: Once the Bazooka is mounted, tighten the check nut with your hand, then lock the lever for more security, as shown in the images. The check nut rotates anti-clockwise, and the more you turn it, the tighter it will be.

- Loosen the ratchet knob of the Camera Riser (Not Included).

- Mount the Camera Riser (Not Included) on the Bazooka.

NOTE: For accessorizing, mount the Camera Riser (Not Included) on the Bazooka and tighten its knob to secure it properly.

- Loosen the locking knob of the 100mm Fluid Head (Not Included).

- Remove the locking knob of the Fluid Head (Not Included).
- Mount the Fluid Head on the Camera Riser (Not Included) through the screw.

- After mounting the Fluid Head (Not Included), secure using the locking knob.



- Unlock the red locking lever of the Fluid Head **(Not Included)** and remove its Quick Release Plate.
- Attach the Quick Release Plate with the Camera **(Not Included)**.



- After attaching the plate, tighten the screw using a screwdriver.
- Mount the Camera **(Not Included)** on the Fluid head **(Not Included)**.



- After mounting the Camera **(Not Included)**, press the locking lever to secure it properly.



Push/Pull Bar Direction Change Assembly

- Loosen the knob of the Platform Dolly and insert the Push/ Pull Bar in the provided holes.
NOTE: The Push/ Pull Bar can also be mounted on the other side of the Dolly.



- After attaching the Push/Pull Bar, re-tighten the knob to secure the attachment.



Tripod Holder (Spiked Feet) Assembly

- Detach the Tripod Holder (Spiked Feet) as shown in the image.



- Now, the Tripod Holder Spiked Feet is fully detached.



- Mount the Tripod Holder (Spiked Feet) on the Platform Dolly by inserting the top rubber portion of the feet holder from above and the lower knob portion from the bottom of the Dolly.



- After attaching the Tripod holder Spiked Feet, secure them using the knob.



- With the help of the knob, the Tripod Holder Spiked Feet is properly secured on the platform of the Foldable Dolly.
- Attach the other two Spiked Feet Holders using the same process.



- Mount the Tripod Stand (Not Included) on the Foldable Dolly.
- To properly secure the Tripod Stand, stretch the rubber of the feet holder upwards, as shown in the image.



Feature: The platform has built-in cutouts on the board, which fit easily into the twin-pointed legs of the Mitchell Tripod Stand, using Quick-Release straps for secure fixing.



This powerful Dolly ensures the unfailing stabilization of your heavy-duty setup while allowing for effortless movement and precise positioning.



Track Wheels Setup

- Attach the Track Wheels with the Foldable Dolly.



- After attaching the Track Wheels, secure them by tightening the knob.

Feature: The camera dolly ensures seamless integration and smooth movement on the track system having a distance of 24.5 inches.



- The Track Wheel is correctly attached to the Foldable Dolly.
- Mount the Foldable Dolly with Wheels on the track, as shown in the image.



- The Foldable Dolly is successfully mounted on the track, as shown in the image.



- Loosen and remove the locking knob of 100mm Fluid Head (**Not Included**).



- Mount the Fluid Head on the Foldable Dolly using the screw.
- To secure the Fluid Head (**Not Included**), insert a locking knob from the bottom and adequately lock it.



- Remove the Quick Release Plate **(Not Included)** by unlocking the locking lever.



- Attach the Quick Release Plate **(Not Included)** with the Camera and tighten the screws using a screwdriver to secure the attachment.



- Mount the Camera **(Not Included)** on the Fluid Head and use the locking lever to secure the camera.
- The Setup is fully assembled on the 100mm bowl, as shown in the image.



YOUR PROAIM FOLDABLE FLOOR TRACK VIDEO CAMERA PLATFORM DOLLY ALL DRESSED UP AND READY TO GO!



(SHOWN WITH OPTIONAL ACCESSORIES)

Warranty: We offer one year warranty for our products from date of purchase. Within this period of time, we will repair it without charge for labor or parts. Warranty doesn't cover transportation costs nor does it cover a product subjected to misuse or accidental damage. Warranty repairs are subjected to inspection and evaluation by us.

Liability: We are not liable for damage caused by products that we do not supply or from mishandling in transit, accident, misuse, neglect, lack of care of the product, or service by anyone other than our company.

Contact Us: In case of any kind of dissatisfaction, please Contact us immediately and we promise our utmost support and care until you use our product.