

Airwave V5 Camera Vibration Isolator Arm (VI-ARWV-5)

Assembly Manual

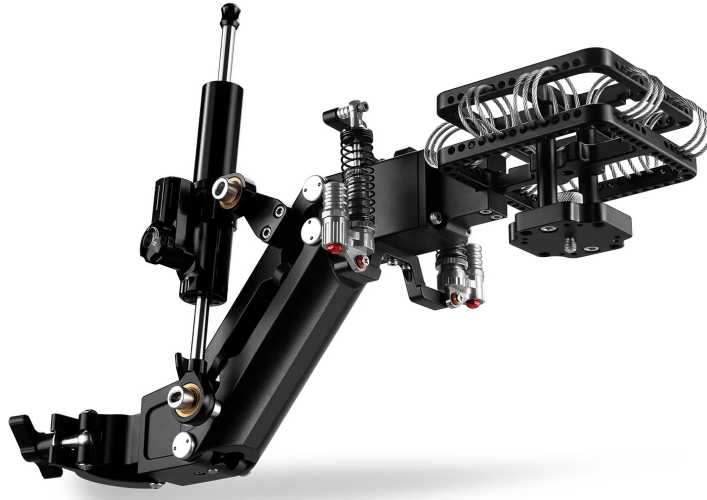

What's In The Box

Please inspect the contents of your shipped package to ensure you have received everything that is listed below.



Airwave V5 Vibration Isolator Arm



Dampener



4 x L-Type Allen Keys
(Sizes: 2.5mm, 3mm, 4mm & 3x16mm)

All rights reserved.

No part of this document may be reproduced, stored in a retrieval system, or transmitted by any form or by any means, electronic, mechanical, photo-copying, recording, or otherwise, except as may be expressly permitted by the applicable copyright statutes or in writing by the Publisher.

Isolator Arm Setup

- Remove both the bolts of the Airwave V5 Vibration Isolator Arm with the help of an Allen Key.

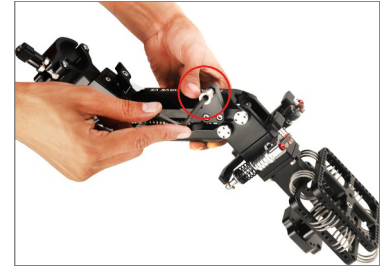
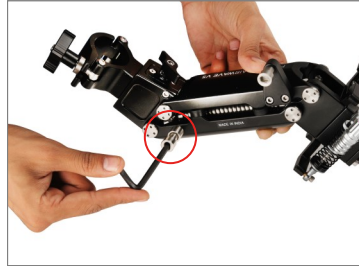

- Both the bolts of the Airwave V5 Vibration Isolator Arm have been removed, as shown in the image.

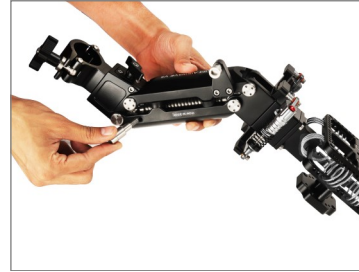

Assembling of Dampener

- Properly attach the dampener to the Airwave Vibration Isolator Arm.



- Now insert both bolts into the dampener and properly tighten with the help of an Allen Key.



- Loosen the clamp knob of the dampener and open the clamp.

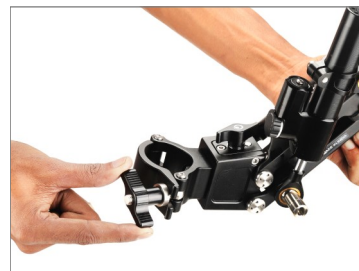

- Mount the dampener on a Rod (**Not Included**) and properly tighten the clamp.

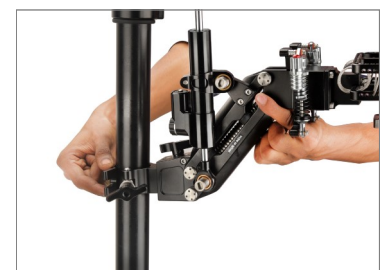

NOTE: The arm is equipped with a hydraulic damping support system and shock-absorbing springs that offer you smooth fluid movements .

- Loosen both bolts from the gimbal mounting platform of the Airwave Isolator Arm using an Allen Key, and remove the gimbal mounting platform.

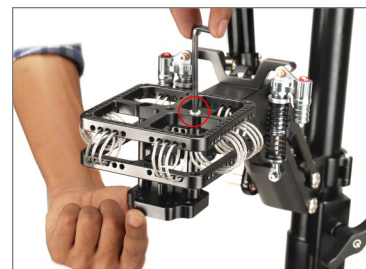
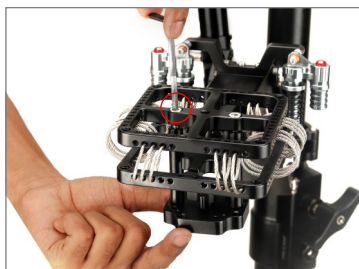

- The gimbal mounting platform has been removed, as shown in the image.



NOTE: In order to smoothen Dampening effect, turn the adjustment knob. If the arm is too soft, turn it towards direction of H (Hard). If the arm is rigid turn it towards the direction of S (Soft).



Gimabl Setup

- Properly attach DJI RS2 Gimbal (Not Included) to the Isolator Arm.

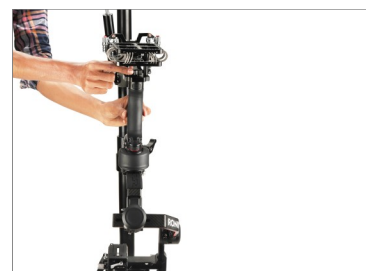

- Press the push pin and remove the camera plate.



Camera Mounting Setup

- Attach the Camera Plate and Camera (Not Included) together and properly tighten with the help of a screwdriver.



NOTE: It has mounting threads to mount various gimbal or camera mounts, such as the DJI Ronin 2/S/S2/SC 2, Zhiyun WEEBILL/CRANE.

**YOUR PROAIM AIRWAVE V5 CAMERA VIBRATION ISOLATOR ARM
ALL DRESSED UP AND READY TO GO!**



(SHOWN WITH OPTIONAL ACCESSORIES)

Warranty: We offer one year warranty for our products from date of purchase. Within this period of time, we will repair it without charge for labor or parts. Warranty doesn't cover transportation costs nor does it cover a product subjected to misuse or accidental damage. Warranty repairs are subjected to inspection and evaluation by us.

Liability: We are not liable for damage caused by products that we do not supply or from mishandling in transit, accident, misuse, neglect, lack of care of the product, or service by anyone other than our company.

Contact Us: In case of any kind of dissatisfaction, please Contact us immediately and we promise our utmost support and care until you use our product.

