

32ft Grand Camera Jib/Crane Package (P-W5R-GRND)

Assembly Manual



What's In The Box

Please inspect the contents of your shipped package to ensure you have received everything that is listed below.

Bag - 1

Jib Sections 3,4,5,6,7,8



Jib Sections

All rights reserved.

No part of this document may be reproduced, stored in a retrieval system, or transmitted by any form or by any means, electronic, mechanical, photo-copying, recording, or otherwise, except as may be expressly permitted by the applicable copyright statutes or in writing by the Publisher.

Bag - 2

Jib Sections 1 & 2, Accessories & Cables

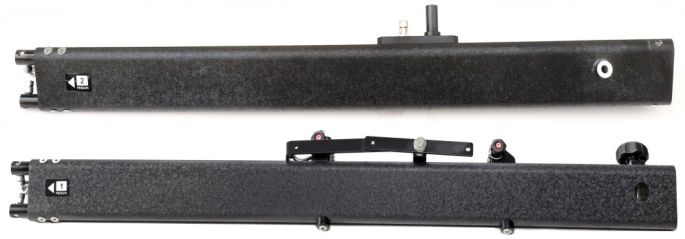

Jib Sections 1st & 2nd



1 x Weight rod



2 x Weight Closers



Cable Guide Support Rods



Central Fork



Head Platform



Tool Pouch



2 x Spanner - 19 & 13



2 x Hooks



Wire Tensioner Hook



7 x Velcro



2 x T-Type Allen keys
5/16mm, 10mm

Red Cables: 5

- 2nd to 1st Section: 4' x 2"
- 2nd to 1st Section: 3' x 5"
- 2nd to 3th Section: 7' x 10"
- 2nd to 8th Section: 15' x 6"
- 2nd to 8th Section: 15' x 6"



Blue Cables: 6

- 1st to 8th Section: 11' x 4" x 2
- 1st to 8th Section: 11' x 4" x 2
- 1st to 8th Section: 11' x 4" x 2
- 1st to 8th Section: 11' x 4" x 2



Yellow Cables : 1

Central Fork to Head Section: 15' x 5"



Bag—3



Tripod stand
Foot

Tripod stand

Bag - 4
Dolly & Accessories



D-37 Dolly



Dolly Platform



2 x Spanner - 17 & 10
1 x T-Type Allen key 4mm



Bag Packing



Spin-3 Pan-tilt Head



Joystick Controller with Cap & Handle



Pan Tilt Mounting Plate and knob



15mtr Control Cable



3mtr XLR Cable



12V AC Adapter



Camera Plate



Joystick Controller Plate



Universal Adapter

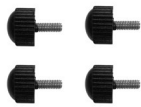

4 x Knobs



2 x 2A Fuse



T-Type Allen Keys
5mm, 4mm, 3mm



Check nut
(Size - 1/4)



L-Type extra Long
Allen Key - 1.5mm

Proaim Lanc Zoom Controller (P-ZC-3DV)



Proaim Lanc Zoom
Controller
(P-ZC-3DV)



15 mtr Long wire



1 mtr wire

INDEX

Sr. No	Particulars	Page No.
1	Safety Hint of Jib Crane	6
2	D-37 Dolly Setup	7-8
3	Tripod Stand Assembly	8
4	Central Fork Assembly	9
5	Jib Section Setup	9-10
6	Head Platform Setup	11
7	Cable Guide Support Rod Setup	11-12
8	Red, Blue & Yellow Wire Assembly	12-15
9	Weight Rod Assembly	16
10	Spin-3 Pan Tilt Head Setup	16-17
11	3-Axis Joystick Controller Setup	17-18
12	Balancing Points of Pan Tilt Head	18-21
13	Lanc Zoom Controller Setup	22-26
14	Final Setup	27



Safety Hints of Jib Crane

ATTENTION: PLEASE READ THIS BEFORE USING TO PREVENT DAMAGE TO EQUIPMENT & OPERATOR!

- The crane may not be assembled or operated under influence of alcohol, drugs or any other intoxicating substances. Lack of attention while connecting the components together can cause substantial damage to equipment/operator.
- The crane may only be operated on levelled horizontal position. Make sure that the surface is stable.
- To prevent any harm or injury, properly join all sections of the crane. It is suggested to use the support stand while telescoping the complete length.
- Always connect the steel cables properly to provide stability to the system. They should not negatively impact the movements of crane in any way.
- After setup of the crane, the pan-tilt head / gimbal head shall be positioned under the central pivot section. In assembled state, when the pan-tilt head / gimbal head is higher than central pivot section, there should be someone to look after the crane system.
- The complete panning & lifting range around it must be kept free. Avoid anybody standing under the crane. No loose objects may be stored or placed on it. Be very careful while using indoors.
- Never operate the crane in the immediate vicinity of high-voltage power cables. It holds danger to life.
- Particular care is required when operating the crane in unfavourable weather conditions. The crane must be shut down in sufficient time. When it is used in a rainy day, the pan-tilt head / gimbal head and controlling bar shall be protected against rain.
- When you want to transport the crane, lock the Pan & Tilt Axis for safety. Make sure that the components do not rub together and cause any material wear.
- Before the counterweights are removed, ensure the remote head is resting on the support stand. Then gradually remove the counterweights before remote head, camera or other parts.
- In the interest of safe crane operation, avoid abruptly swivelling or stopping the crane, otherwise it may cause serious damage to equipment.

FOLLOWING THESE GUIDELINES WILL PROVIDE BETTER SHOTS AND TROUBLE FREE OPERATION. SHOULD YOU NEED ADDITIONAL INFORMATION, TECHNICAL ASSISTANCE IS AVAILABLE 'ONLINE' BY CONTACTING THE SALES REPRESENTATIVE.

D-37 Dolly Assembly

NOTE: To avoid unwanted accident while assembling the crane, please assemble the dolly with supporting feet. It also increases the stability.

- Loosen and remove the Allen bolts & Washer from the outer legs of the dolly using a spanner.



- After removing the bolt along with the washer properly pull each leg out until it reaches the joining point.



- After spreading both the legs of the D-37 Dolly, Insert the bolt with the washer, nut matching the bottom thread of the dolly.



- Properly tighten the bolt and nut using a spanner.
- Follow the same process for the remaining legs.



- Now, loosen and remove the bolts, washer & bolts of the D-37 Dolly leg using the Allen key, as shown in the image.



- Similarly, remove the bolts of the remaining leg and place the dolly platform on the Dolly.

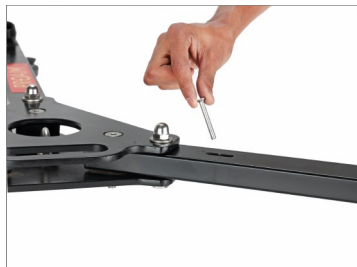

- After attaching the dolly platform to the D-37 Dolly, screw in the Allen bolts to desired positions and tighten all the connections with the help of Allen key.



- The Platform Dolly is properly attached as shown in the image.



■ Tripod Stand (W5-STD) Assembly

- Attach the stand foot by twisting it into the leg of the Tripod Stand.



- Similarly, follow the same process for the remaining legs as shown.



- Set the position of the wheels and lock the wheels with the provided Lever which allows you to have stable shoots.
- Attach the legs of tripod stand with D-37 dolly as shown in the image.



- Properly align and attach the legs of the Tripod Stand on the D-37 Dolly.

Feature: Jib Stand with a versatile Dolly facilitates a sturdy base & impressive payload in any terrain.



Central Fork Assembly

- Detach the Locking Clamp from the Central Fork and mount it on the Tripod Bowl.



- Then, re-tighten the locking clamp and securely attach the Central Fork, as shown in the image.

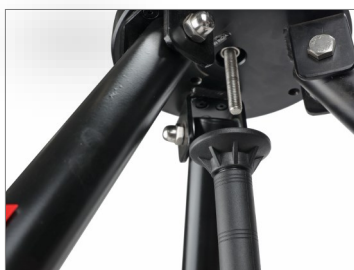

- To add stability to your Jib, attach the wire tensioner with the hook on the locking clamp, then attach the safety chain with the pin on the D-37 Dolly.

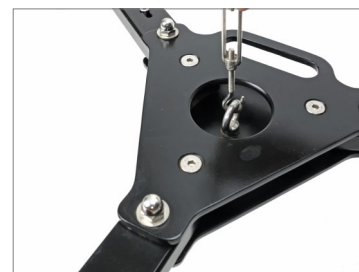
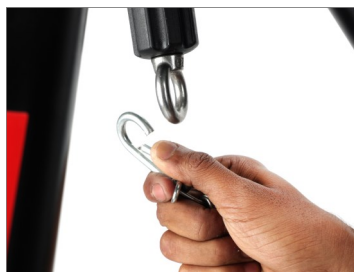

- Wire tensioner and safety chain setup should be properly aligned to ensure stability.

Feature: Central Fork that offers smooth pan-tilt movements while absorbing unwanted vibrations or movements.

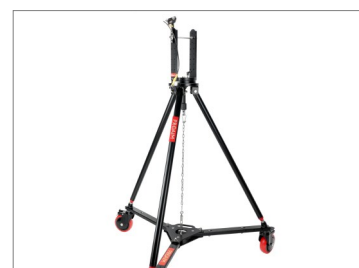

Jib Sections Setup

- Loosen and remove the bolts, washer, nuts of the Central Fork using the Allen Key and Spanner.

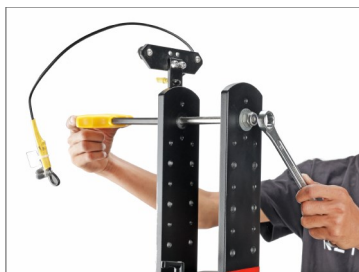

- Mount the second section by matching it to the center of the central fork.

Feature: Modularly designed heavy-duty crane transforms into various sizes with adjustable arms ranging from 12ft to 24ft.



- Align the 2nd section with the Central Fork and insert the bolt and nut into it.



- Now, tighten and secure it using the Spanner and Allen Key.



- Remove all the bolts with the help of the Allen key before connecting Section 1st to Section 2nd.



- All the bolts are properly removed, as shown in the image.



- Now, align both the sections and Install the Allen screws to the joining holes of both the sections and tighten.



- Now, tighten the all bolts properly to secure the jib section together.



- Using the same approach insert 3th, 4rd and remaining sections to the joints and secure via bolts, as shown in images.



Head Platform Setup

- Loosen the bolt of the Head platform and remove the attached nut and washer.

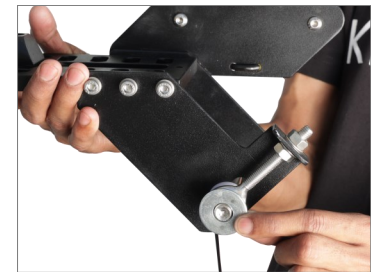

- Remove the threaded pin from the head platform to install the head platform assembly.

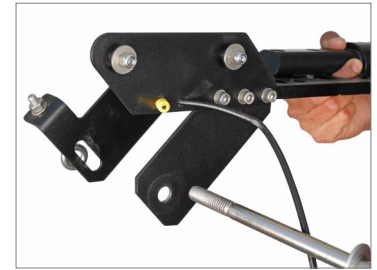
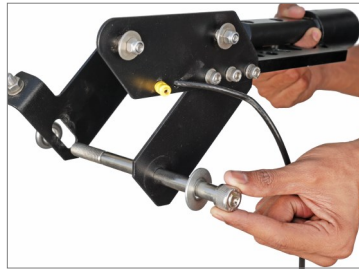

- Install the Head Platform assembly (leveling arm up) to the end of the smallest section with the provided bolt, shaft collars, washers, and nut.



- Tighten all the Allen bolts, nuts with the help of Allen and wrench to secure them properly.



Attaching the Cable Guide Support Rod

- Insert and secure the cable guide support rods by matching them with the Section 2 cable guide Clamp.

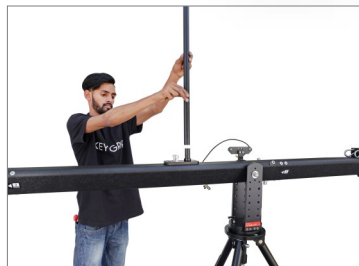

- Loosen and remove the bolt of Section 2 using the Allen key.

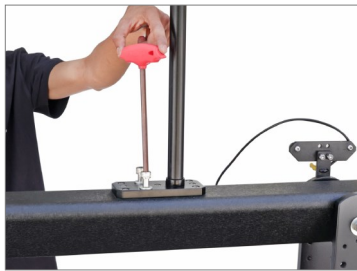

- Align the cable guide support rod on Section 2 and re-insert the bolt.

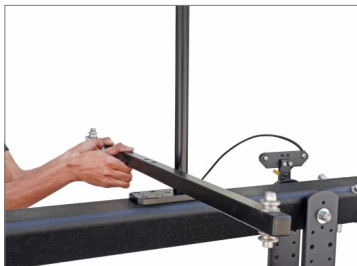

- Re-tighten the bolt using an Allen key as shown in the image.

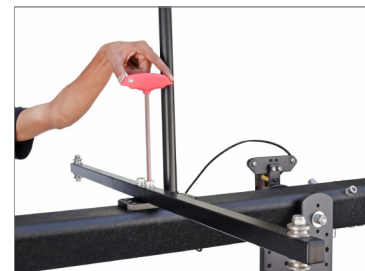

- Attach 2 big hooks on both slots on cable guide.
- Follow the same process for the second pair of hooks.

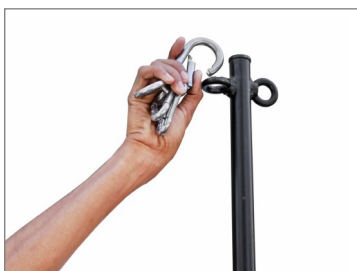

Attaching the **Red** Stability Cables

NOTE: Its color-coded suspension cables let you assemble the entire setup quickly.

- Insert one end of the cable into the hook of the cable guide rod, then attach the other end of the cable to the clamp of Section 1.

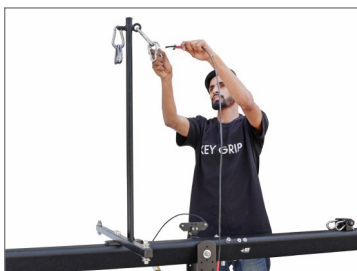

NOTE: If the length of the wire is short, loosen the hook to increase its size.

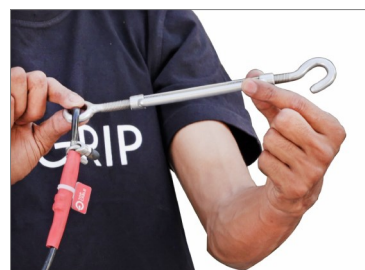

- Red wire is properly connected with jib section 1.
- Follow the same procedure for the other short red wire as shown in the image.

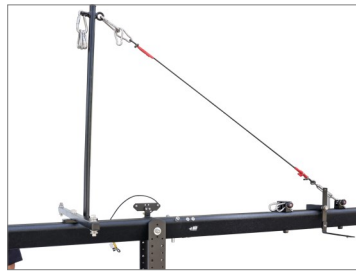

- Insert one end of the cable into the hook of the cable guide rod, then attach the other end of the cable to the clamp of Section 8.



- Follow the same process to attach the 2nd wire with the Jib, as shown in the image.

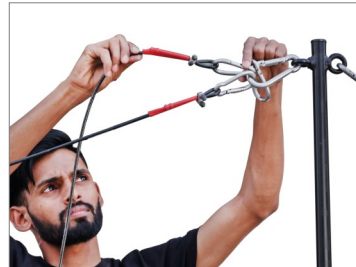

- Insert one end of the red cable into the hook of the cable guide rod section 2nd then attach the other end of the cable to the clamp of Section 8.

Feature: Its color-coded suspension cables let you assemble the entire setup quickly.

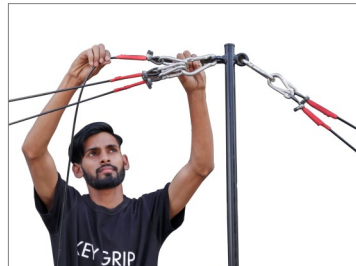

Attaching the Blue Stability Cables

- Attach the two Blue cables with the hook of Section 1.

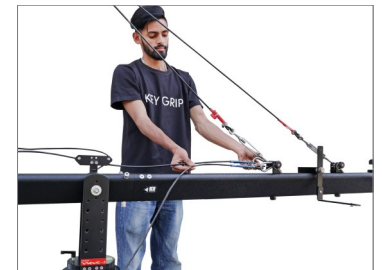
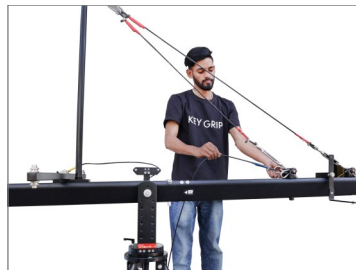

NOTE: Align the cable to the cable guide from side and adjust the cable with help of wire tensioner. Same approach apply at other side of jib

- Connect the end of the two blue cables into the slot of section 8th with the help of the knob.



- Connect the other blue wire into the slot of the same jib section 8 and adjust the length of the wire with the help of a wire tensioner.

- Hook 1 meter blue cable to the wire tensioner and hook it into the cable slot of section 8th of the jib section then secure the wire with the help of the locking knob.

NOTE: If the length of the wire is short, loosen the hook to increase its size.

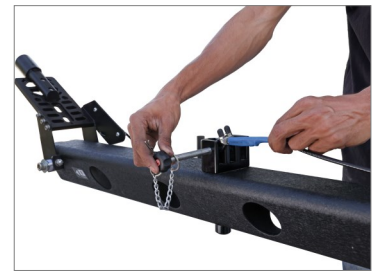

- Similarly, attach the other hook joint properly to the other wire part and secure the wire.



- After attaching the blue wire, lock the wire properly with a safety pin.
- The blue wire is properly connected to the jib section as shown in the image.

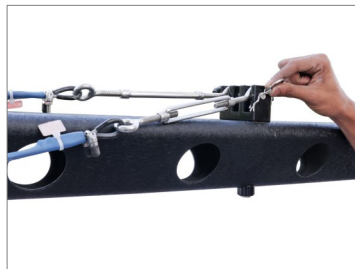

Attaching the **Yellow** Stability Cables

NOTE: Join all the yellow cables together, make one long cable, and attach it to the Jib.

- Connect the yellow cable to the hook already attached to the central fork yellow wire.



NOTE: If the length of the wire is short, loosen the hook to increase its size.

- Connect the yellow cable to the wire attached to the head section.

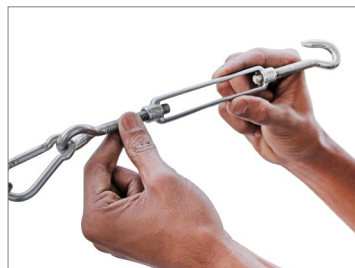

- Similarly, connect the other hook joint to the other wire part properly.



Fits Different Shooting Length 16ft, 24ft & 32ft



- Attach the LCD (**Not Included**) to the LCD mounting arm insert the screws by aligning the holes with each other then tighten with the help of Screw Driver.
- LCD is properly assembled with mounting arm as shown in the image.



Weight Rod Assembly

- Loosen the knob of the jib section and insert the weight rod into it.



- After inserting the weight rod, retighten the knob to ensure slip free connection. Then put weight (**Not Included**) to both ends of weight bar rod.



- After adding weight, insert weight closure to secure the weight properly.

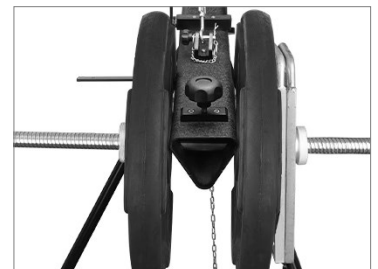

Spin-3 Pan Tilts Head Setup

- Attach the Spin-3 (3-Axis) Pan Tilt Head into the head platform mounted on the end of the jib.



- Then secure the pan-tilt head using the provided knob, as shown in the image.



- Now, PT-SPIN-3 is properly attached to the front of the Jib section.
- Mount your camera (Not Included) on camera mounting plate of Pan Tilt Head.



- Insert the check nut through the bottom of the head and secure the camera with the help of an Allen key.



- Camera is properly secured with head section as shown in the image.



3-Axis Joystick Controller Setup

- Connect the handle to the joystick controller as shown in the picture.



The Pan Tilt Head circuitry is built entirely into the Joystick Controller. The only requirement is AC adapter (Included) or Battery Power (Not included). The AC adapter can handle 100-240 volts. Users will need the appropriate plug adapter for local use.

- Install your cable starting at the camera end and making sure to leave enough slack for full pan and tilt movements.
- Connect 15mtr control cable with motor cable.



- Then connect the other cable to the main cable port on the joystick controller.

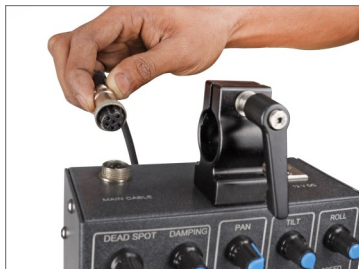

- Install 12 volt AC adapter (4 pin XLR) in the socket of Joystick Box.

NOTE: Any 12 volt battery may operate this Pan Tilt Head as long as the Connector and the #1 Negative pin & #4 Positive pin of Cable meet together.



- (4 pin XLR) and controller cables are both installed in the sockets of the joystick box.
- Insert the joystick box into the weight rod.

CAUTION: The power specification we have provided is as per 12volt. For this, we provide a 12volt/3ampere regulated power adapter. In case you use a voltage higher than 12V, it will affect the performance and life of the motor, and there is a high risk of the motor getting damaged.



- After inserting the joystick box into the weight rod, tighten the knob properly to secure it.
- Spin-3 (3-Axis) Motorized Dutch Roll Pan Tilt Head is properly assembled with jib section.

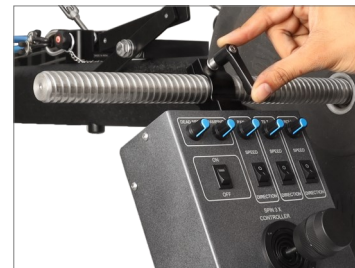

Balancing Points

Follow these steps to Balance the Pan Tilt Head

- Find the horizontal balance point of your camera by using 2 fingers of one hand while holding handle.
- Mark this point on the side of the camera with chalk or tape.
- Turn the unit on and move the tilt control until the camera plate is vertical.
- Loosen the two screws holding tilt motor.
- Grasp the motor and turn slightly to disengage gears.
- Mount the camera to the camera plate with the screw provided.
- Tighten by threading the nut up to the bottom of the camera plate securely.
- Make sure your balance point previously marked with chalk or tape is in the middle of the plate.
- Loosen the knob below the camera plate and slide the camera and plate up or down until the centre line of your camera is about in the middle of the large gear. Now tighten knob.
- If the camera is perfectly balanced it will stay in any position while motor gear is still unattached.
- Grasp the motor and turn it back until the gears mesh.
- Gently tighten motor screws.
- Secure the camera.

NOTE: All reduction boxes have a small amount of backlash. The balancing of the camera will reduce the backlash to a minimum making it felt at the top of the tilt.

Balancing Tips:

32' Jib

Weights required for balancing only Jib (without camera & Pan Tilt) is: 98 Kg (216 lbs)

For balancing 7 Kg (15.4 lbs), we further need another 45.5 Kg (100.3 lbs), the formula is:

(Weight of Camera + Pan Tilt) x 6.5 = Additional counter weight required to balance the equipment on the Jib

(e.g. 7Kg x 6.5 = 45.5 Kg)

Total recommended weight: 143.5 Kg (316.3 lbs)

28' Jib

Weights required for balancing only Jib (without camera & Pan Tilt) is: 67.7 Kg (149.3 lbs)

For balancing 7 Kg (15.4 lbs), we further need another 39.2 Kg (86.4 lbs), the formula is:

(Weight of Camera + Pan Tilt) x 5.6 = Additional counter weight required to balance the equipment on the Jib

(e.g. 7Kg x 5.6 = 39.2 Kg)

Total recommended weight: 106.9 Kg (235.7 lbs)

24' Jib

Weights required for balancing only Jib (without camera & Pan Tilt) is: 47.7 Kg (105.2 lbs)

For balancing 7 Kg (15.4 lbs), we further need another 29.4 Kg (64.8 lbs), the formula is:

(Weight of Camera + Pan Tilt) x 4.2 = Additional counter weight required to balance the equipment on the Jib

(e.g. 7Kg x 4.2 = 29.4 Kg)

Total recommended weight: 77.1 Kg (170 lbs)

20' Jib

Weights required for balancing only Jib (without camera & Pan Tilt) is: 25.3 Kg (55.8 lbs)

For balancing 7 Kg (15.4 lbs), we further need another 25.9 Kg (57 lbs), the formula is:

$(\text{Weight of Camera} + \text{Pan Tilt}) \times 3.7 = \text{Additional counter weight required to balance the equipment on the Jib}$

(e.g. $7\text{Kg} \times 3.7 = 25.9 \text{ Kg}$)

Total recommended weight: 51.2 Kg (112.8 lbs)

16' Jib

Weights required for balancing only Jib (without camera & Pan Tilt) is: 12.7 Kg (28 lbs)

For balancing 7 Kg (15.4 lbs), we further need another 17.5 Kg (38.6 lbs), the formula is:

$(\text{Weight of Camera} + \text{Pan Tilt}) \times 2.5 = \text{Additional counter weight required to balance the equipment on the Jib}$

(e.g. $7\text{Kg} \times 2.5 = 17.5 \text{ Kg}$)

Total recommended weight: 30.2 Kg (66.6 lbs)

12' Jib

Weights required for balancing only Jib (without camera & Pan Tilt) is: 1.7 Kg (3.7 lbs)

For balancing 7 Kg (15.4 lbs), we further need another 10.5 Kg (23.1 lbs), the formula is:

$(\text{Weight of Camera} + \text{Pan Tilt}) \times 1.5 = \text{Additional counter weight required to balance the equipment on the Jib}$

(e.g. $7\text{Kg} \times 1.5 = 10.5 \text{ Kg}$)

Total recommended weight: 12.2 Kg (26.8 lbs)

■ Operation

- With the camera set up as previously described above, Power ON by pressing the RED Switch on the top of the Joystick control box.
- For inverted use, disconnect the leads to the motors, rotate the control box 180 degrees and re-install.

NOTE: Remember practice makes perfect and always watch the cables for binding.

JOYSTICK

The joystick is a three-axis variable speed servo controller. The further you move in one direction the faster the output to that motor. This will be a little tricky at first, but little practice will improve your success. The joystick may be operated in a handheld position or from a flat surface such as a tabletop, or attached to the boom arm of Jib.

NOTE: After plugging the power cord into a proper outlet, press “power on”. The LED light on the control box should illuminate and the head may jump slightly on start up or shut down. This is normal. This can be controlled by Dead Spot. Adjust the joystick to ensure correct movement of the head. It may be necessary to reconnect to the motors if required.

POWER CONTROL

To the right and above the joystick is a knob labeled "SPEED".

This is the power control knob. Turning to the right will be full power and back to the left will decrease the available power to both pan and tilt operation. The advantage of power control is to be able to limit power when only slow accurate movements are needed. With the power control at half power (approx. 8 volts max. output) the full range of motion on the joystick will be between 0 and 8 volts making finer adjustments possible. The power control will be usable between a range of approximately 4 volts to 12 volts.

DEAD SPOT

The knob to the left is marked Dead Spot. Turned all the way to the left (counterclockwise) will create the smallest dead spot. Meaning that the head will begin to move as soon as the smallest deflection of the joystick is made. Moving to the right will increase the area where no power is sent to head motors. At half way, the dead spot will close again, this helps to avoid crossing the tilt when only pan movement is desired.

The dead spot is so tight when the control knob is all the way to the left, it may be necessary to back it off slightly until no movement is seen in either axis.

NOTE: With the dead spot all the way left the head may move in both axis on it's own. The dead spot should be set at approx. the 9:00 position to insure that no unwanted movement occurs.

Linear or Logarithmic taper joystick control

All joysticks are linear, meaning that each degree of movement of the stick correlates to the output. On the 12 volt PROAIM PAN TILT HEAD half deflection of the joystick means approximately 6 volts sent to the motors. But with the advent of Digital we can now control the taper of the joystick, making in Logarithmic as well. Logarithmic taper being that the first of joystick movement only sends a small amount of power to the motors and the last of the deflection will send more power per degree of deflection. On Logarithmic taper 1/3 of joystick deflection might yield 2 volts output the next 1/3 will yield 4 volts output and the last 1/3 of yields 6 volts for a max. again of 12 volts. This mode gives the operator fine slow movements yet retains the ability to go to max. speed if necessary.

TILT DIRECTION SWITCH

The Pan-Tilt can be mounted either vertically or underslung on a jib. Changing its position from vertical to underslung or vice-versa requires the reversal of direction as well. By switching “on” the tilt direction switch, we can immediately reverse the direction.

PAN DIRECTION SWITCH

The Pan-Tilt can be mounted either vertically or underslung on a jib. Changing its position from vertical to underslung or vice-versa requires the reversal of direction as well. By switching “on” the pan direction switch, we can immediately reverse the direction.

Counterweights

The Jib is setup with “plate weights” or bar bells” style weights. Plate weights come in several weights and diameters. They get smaller as the weights get lighter. The largest (25lbs) is about 11 inches in diameter. The mounting hole is 1” in diameter for all weights. The jib has a varying weight ratio depending on the length you have chosen. The 24.5ft arm itself balances at about 121.5 lbs. Just multiply the weight, of the additional items you will put on the end of the arm, by 5 and you will know how much weight to buy. Buy a few extras in case you add other accessories. The lighter weights will allow you to “fine tune” once you’re ready to go.

■ Lanc Zoom Controller Setup

- Loosen the back knob of the Zoom Controller.

NOTE: Zoom Control for DV Cameras is a universal controller for LANC and Panasonic Mini DV or HDV cameras.



- After loosening the knob, insert it into the weight rod per your requirement and secure it in its position by re-tightening the knob.



- Zoom Controller is properly attached to the weight rod.

CAUTION: This equipment may cause harm if not installed and used per the instructions.



NOTE: You can attach the zoom controller on the left or right per your required position.



About P-ZC-3DV Product

Proaim's Lanc zoom controller is a universal controller for both LANC and Panasonic DV cameras, with a converter switch that allows for variable-zoom speed from slow to fast. The zoom lever allows you to zoom out to wide-angle or zoom in to telephoto. Lightweight and compact controller features an outlet cable that can be clamped on tripod pan handles, monopods, stabilizers, and other such devices. Works perfectly with Sony, Panasonic & Canon cameras with a 2.5mm mini-jack LANC input.

Warning: Before operating this equipment, please read this manual carefully and retain this for future reference.

This equipment may cause harmful, if not installed and used in accordance with this manual. Please follow this instruction for your safety reason.

ATTENTION TO USERS

CAUTION: This equipment may cause harm, if not installed and used in accordance with following instructions.

- Change over to corresponding camera mode.
- Make sure that cable terminal position is fit to unit.
- Wrong usage may cause problem.
- Do not fix with intense force as it may cause unexpected damage.
- Do not use excessive force during usage.
- Do not pull out the cable which may cause malfunction.
- Please avoid water and rain drop in order to avoid the malfunction.
- Do not subject this unit to strong vibrations or shocks .
- Do not expose the unit in direct sunlight, near heat producing objects, in a hot car, or in other hot places, as this may deform or discolor the unit.
- Do not apply organic solvent such as thinner.
- Misuse of this product may cause damage or malfunction.
- Do not disassemble or modify as it may cause functional faults.

CAUTION FOR USERS

1. Change the camera mode.

Not all function may be available depending on camera working mode (e.g).

If using Sony camera memory mode the “Record start/stop” functions will not work. And some functions may not work with some old cameras.

2. Keep the cable socket and stereo mini jack clean at all times.
3. Remove the unit after usage.

SET THE CORRESPONDING MODE

Following are abbreviation for camera manufacturers for setting the mode

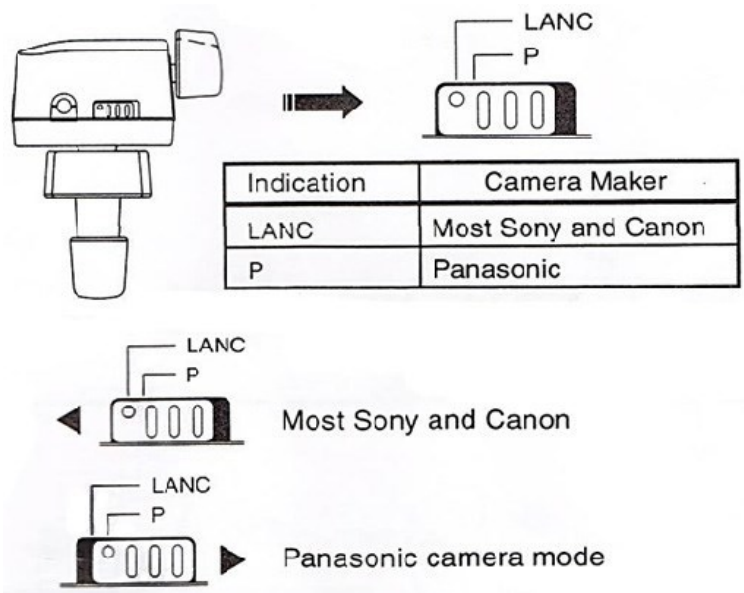

DETAILS OF ZOOM CONTROL

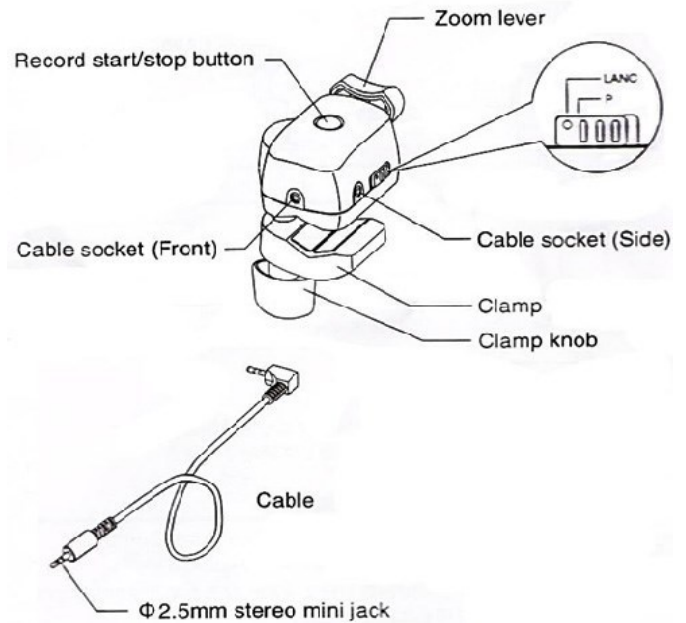

ATTACH TO THE PAN HANDLE

1. Loosen the clamp knob till enough space is available.
 2. Attach to the pan handle.
 - Centre of pipe should fit in the clamp "V" shape.
 - Firmly tighten the clamp by using hands.
- CAUTION:** Do not use excessive force.

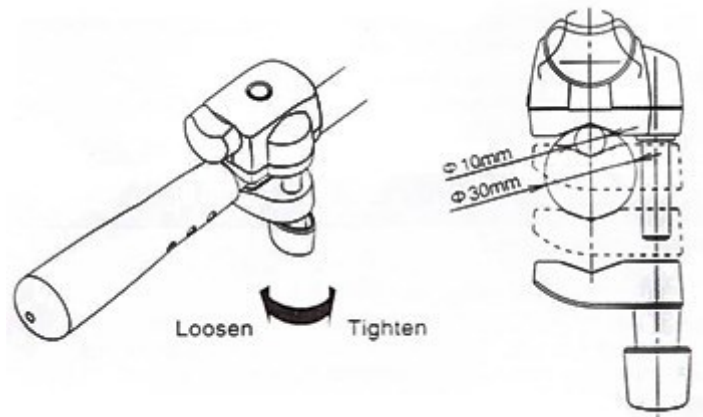

FIX THE CABLE TO ZOOM UNIT

- Front and back side has Cable socket.
- Insert the cable per your requirement. It works same from both front and side position.

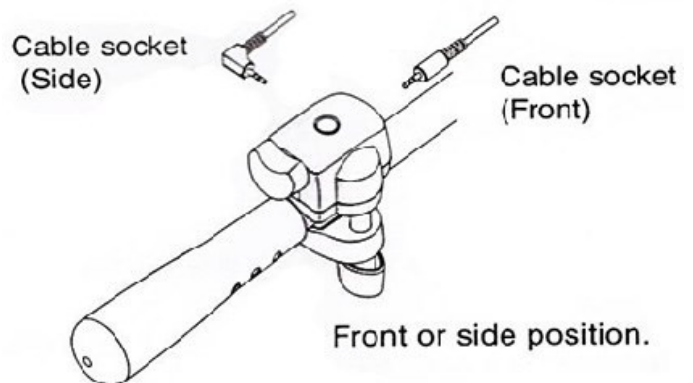

ATTACH THE CABLE TO CAMERA

Make sure that switch is changed to corresponding mode.

1. Make sure that position is available on camera.
2. Make sure that camera is switched off.
3. Insert the cable at designated position.

CAUTION: Do not insert at wrong position which will cause unexpected damage.

OPERATION

- Record start/stop button This changes the mode of "Record start" and "Record stop" alternatively.
- Zoom lever (Variable speed zoom) "W"
Indication: Turn toward "W" to zoom out to wideangle.
"T" Indication: Turn toward "T" to zoom out to telephoto.

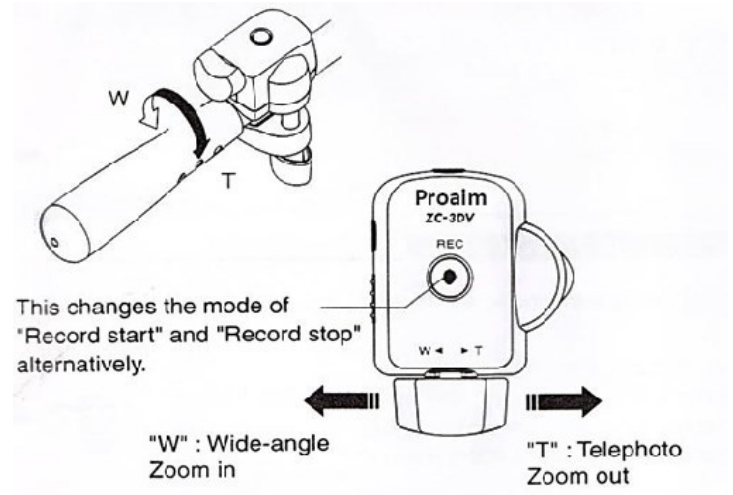

STORAGE

When not in use, insert the stereo mini jack into both the sockets, as shown in the image.

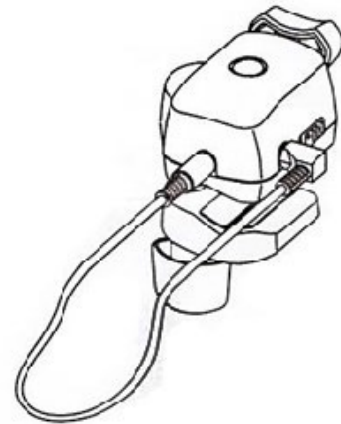

SPECIFICATION

Clamp distance: \varnothing 10mm (0.39 inch) - \varnothing 30mm (1.18 inch)
 Cable Socket : \varnothing 2.5mm stereo mini jack
 Cable length : \varnothing 510mm (20 inch)

**YOUR PROAIM 32FT GRAND CAMERA CRANE FILM PRODUCTION PACKAGE
ALL DRESSED UP AND READY TO GO!**



(SHOWN WITH OPTIONAL ACCESSORIES)

Warranty: We offer one year warranty for our products from date of purchase. Within this period of time, we will repair it without charge for labor or parts. Warranty doesn't cover transportation costs nor does it cover a product subjected to misuse or accidental damage. Warranty repairs are subjected to inspection and evaluation by us.

Liability: We are not liable for damage caused by products that we do not supply or from mishandling in transit, accident, misuse, neglect, lack of care of the product, or service by anyone other than our company.

Contact Us: In case of any kind of dissatisfaction, please Contact us immediately and we promise our utmost support and care until you use our product.