

Comet Mini 4.5ft Euro/Elemac Camera Jib (JB-CMTM-01)

Assembly Manual



What's In The Box

Please inspect the contents of your shipped package to ensure you have received everything that is listed below.

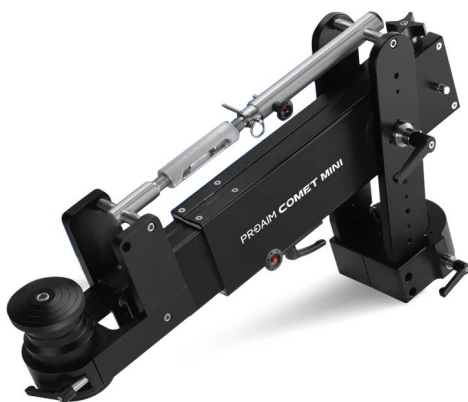

Proaim 2.5ft Comet Mini Jib



1 x 2ft Extension Arm



2 x Counter weight Rods
1 x Extension rod



Flight Case

All rights reserved.

No part of this document may be reproduced, stored in a retrieval system, or transmitted by any form or by any means, electronic, mechanical, photo-copying, recording, or otherwise, except as may be expressly permitted by the applicable copyright statutes or in writing by the Publisher.

Comet Mini Jib Setup

- Place the euro adapter plate (Not Included) to the center hole of the Spin Dolly (Not Included).



- Attach the euro adapter plate (Not Included) to the Spin Dolly (Not Included) with the help of the bolt and then tighten it using the Allen key.

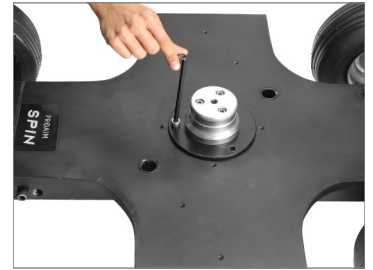

- Similarly, tighten all the other bolts to firmly secure the euro plate adapter (Not Included).



- Loosen the ratchet knob of the Flexino Bazooka (Not Included) and mount it on the euro adapter (Not Included) placed on the Spin Dolly (Not Included).



- After mounting the Flexino Bazooka (Not Included), secure it by properly tightening the ratchet knob.



- Place the Comet Jib onto the euro adapter of center column.



- Fix the jib fork with the center column by locking the knob via locking lever.



- Comet Jib is properly attached.



- Then pull & take out the side knob of the jib.



- Loosen the knob located at one of ends of the jib, & pull out the telescopic section, as shown in the image.



- Re-Insert the side knob to lock it.



- Unlock the rod pin, Then insert the counterweight rod through the hole.

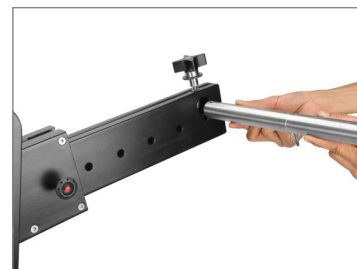

- Then add weights (**Not Included**) on both the rods accordingly and secure them with the locking pins.

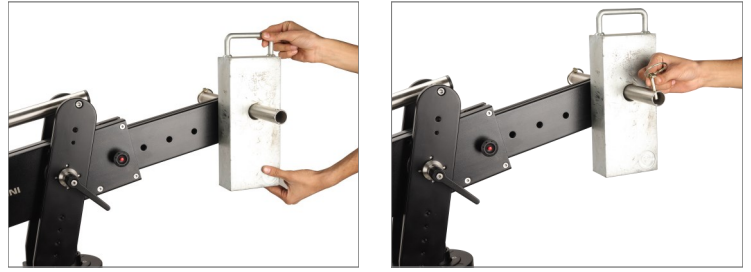

2 different length rods of counterweight for easy balancing

NOTE: It comes with two counterweight rods that let you hang dumbbell weights for counterbalancing.



Dynamic Moves For Your Camera Varied Tilting Range for Varied Lengths



- The Comet jib provides 360° rotation with its panning knob.

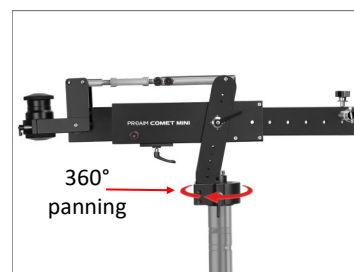

- Loosen and remove the adapter knob present on the front of the Comet jib.



- Loosen the ratchet knob of the offset bracket (**Not Included**) and mount it on the front section adapter of the jib.

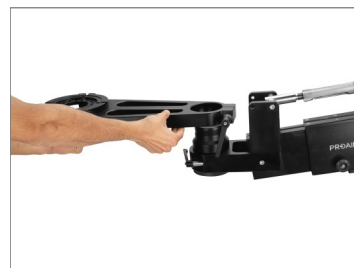

- Now, properly secure the offset bracket (**Not Included**) by tightening the ratchet knob and adapter knob.



Mounting of Fluid Head

- Loosen the Castle Ring of the Fluid Head (**Not Included**) and mount it on the Offset Bracket.



- After mounting the fluid head, attach the castle ring to the bottom of the fluid head.



- Now, secure it with the castle nut.



- Push the button of the Fluid Head **(Not Included)** and remove the Camera Plate.



- Attach the Camera Plate to the Camera **(Not Included)** by matching the threads and properly secure with the help of a screwdriver **(Not Included)**.



- Slide the Camera onto the Fluid Head and properly lock it with the help of the locking pin.



NOTE: The Comet can be combined with additional Proaim accessories, Suitable for all standard Euro / Mitchell Remote Head systems.



Extend the length of Comet Jib

- Push the knob present on the front section of the comet jib and properly remove it.



- Now, loosen the ratchet knob present on this knob.



- You can set the required height by removing the push pin present on the top most rod of the Comet Jib.



- Now ,securely re-insert the push pin.



- Firmly secure the ratchet knob by tightening it, as shown in the image.



Extend the length of Comet Jib

- Remove the pushpin present on the top rod of the front section by pushing it.



- Loosen and remove the ratchet knob present on the back side of the Jib.



- Now, detach the front section of the jib ,as shown in the image.

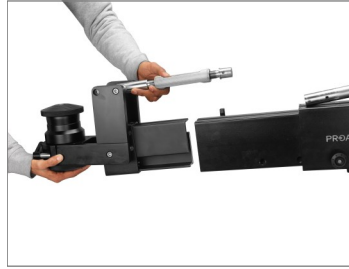

Assembly of Extension Arm

- Properly remove the extension arm by loosening it.



- Insert the extension arm into the Comet Jib.



- Now, re-insert and tighten the ratchet knob.

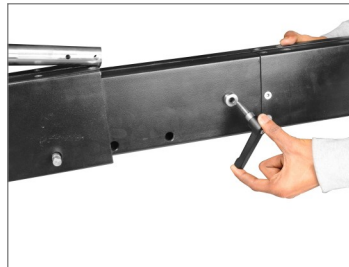

- The extension arm is successfully attached to the Comet Jib.



Assembly of Extension rod

- Carefully align the extension rod with the rod of the Comet Jib and attach it.

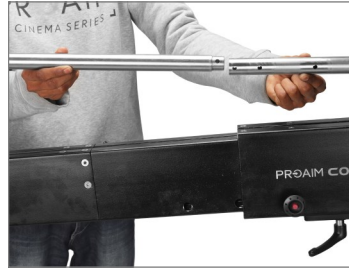

- Now, insert the push pin to secure the rod.



- Insert the head section of the Comet Jib on the extension arm.



- Then, tighten the ratchet knob of the Jib.



- Now, insert the rod of the head section into the hole of the extension rod.



- After inserting the rod, secure it with the help of the push pin.



- Loosen the ratchet knob of the head section of the Jib.



- Loosen the adapter knob present on the head section with the help of Allen key.



- Now, remove the adapter with ease.



Assembly of Boom Rig

- Remove and attach the safety cap of the boom rig (**Not Included**) to the head section of the Jib.



- Now, properly tighten the ratchet knob of the head section to secure it in its place.

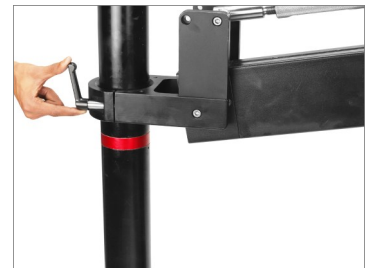

Assembly of Offset Euro

- Insert the offset euro (Not Included) with the bottom of boom rig (Not Included) by loosening the ratchet knob.



- Set the offset euro (Not Included) in the boom rig (Not Included) as per your requirement and tighten it with the ratchet knob.



- Now, tighten the safety cap of the boom rig (Not Included) to properly secure it.



- Finally, Comet Mini jib Setup is ready to use.



**YOUR PROAIM COMET MINI 4.5FT EURO/ELEMAC CAMERA JIB
ALL DRESSED UP AND READY TO GO!**



(SHOWN WITH OPTIONAL ACCESSORIES)

Warranty: We offer one year warranty for our products from date of purchase. Within this period of time, we will repair it without charge for labor or parts. Warranty doesn't cover transportation costs nor does it cover a product subjected to misuse or accidental damage. Warranty repairs are subjected to inspection and evaluation by us.

Liability: We are not liable for damage caused by products that we do not supply or from mishandling in transit, accident, misuse, neglect, lack of care of the product, or service by anyone other than our company.

Contact Us: In case of any kind of dissatisfaction, please Contact us immediately and we promise our utmost support and care until you use our product.