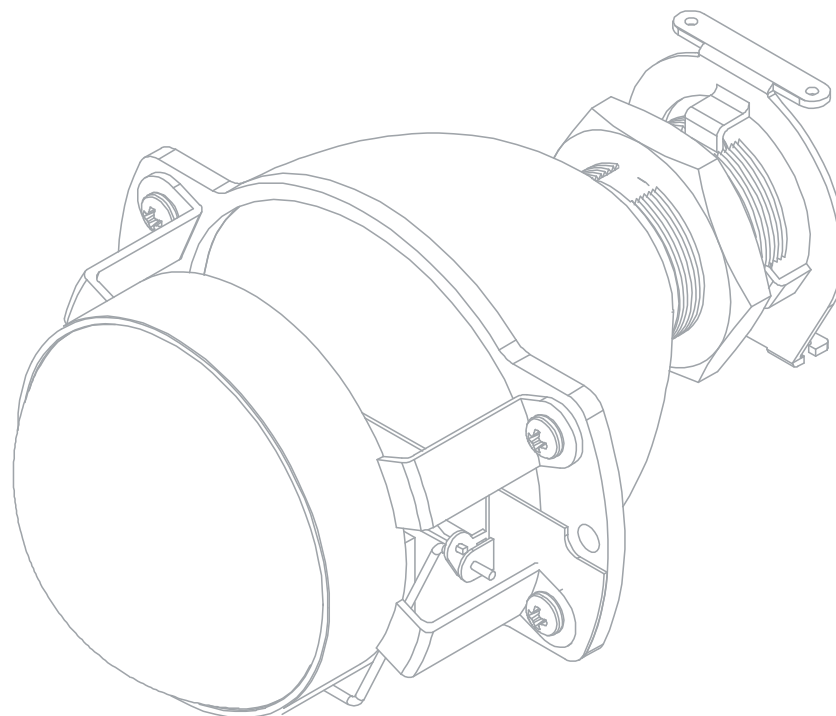




THE AUTOMOTIVE LIGHTING BENCHMARK



INSTALLATION GUIDE

MATCHBOX 2.0 STAGE III KIT


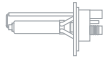

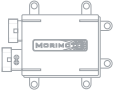





WARNING: By reading this document, I agree it is only to be used as an educational guide. Morimoto Lighting makes no guarantee on any finished results, nor are they to be held responsible for any damage, misuse, or personal injuries. Use at your own risk. If you are unable to clearly understand and adapt the information below to your own application, professional installation is recommended.

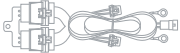






TABLE OF CONTENTS

SYSTEM DIAGRAM (CHOOSE YOURS)	P.3
EXTERNALLY-WIRED W/ CANBUS	P.4
EXTERNALLY-WIRED W/ HD RELAY	P.5
INTERNALLY-WIRED W/ CANBUS	P.6
INTERNALLY-WIRED W/ HD RELAY	P.7
DUAL FILAMENT W/ MOTOCONTROL	P.8
DUAL FILAMENT W/ CANBUS	P.9
HARNES INSTALLATION	P.10
PROJECTOR INSTALLATION	P.10
HARDWARE CONTENTS	P.11
HARDWARE SCHEMATIC	P.11
BULB INSTALLATION	P.11
EXTERNALLY-WIRED INSTALL	P.12
INTERNALLY-WIRED INSTALL	P.12
BALLAST INSTALLATION	P.13
HALO INSTALLATION	P.14
USING RETRORUBBER SEALANT	P.15

STANDARD PARTS

	1 X TEST LEAD
	2X HID BULBS
	2X BULB WIRES
	2X BALLAST COMPUTERS
	2X AMP IGNITERS
	2X HIGH BEAM SPLITTERS
	2X MATCHBOX PROJECTORS

OPTIONAL PARTS

	1 X HD RELAY HARNESS
	1 X CAPACITOR LINK
	2X CANBUS HARNESSES
	2X PROJECTOR SHROUDS
	2X XSB 2.0 LED HALOS
	2X CARBON FIBER BALLAST BRACKETS
	1 X RETRORUBBER SEALANT

SPECIAL NOTE:

The included ballast test lead is used for troubleshooting purposes only and is not part of the installation of this system. If necessary, the test lead can be plugged into the ballast input then connected to a 12V+ source to test the ballast. This must be done with the bulb connected to the ballast prior to applying power.



Ballast Test Lead

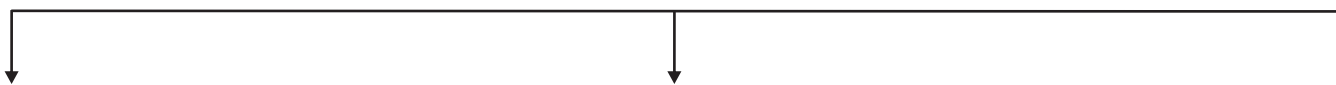


NOTE: System diagrams are to be used for reference purposes only. If you are unsure of the installation procedure for any individual part, review its install procedure prior to proceeding.

IDENTIFYING YOUR INSTALLATION TYPE



NOTE: There are three types of wiring installations with this system: EXTERNAL LOW-BEAM, INTERNAL LOW-BEAM, and DUAL FILAMENT. The installation guide that follows will cover all three types.



EXTERNAL LOW-BEAM

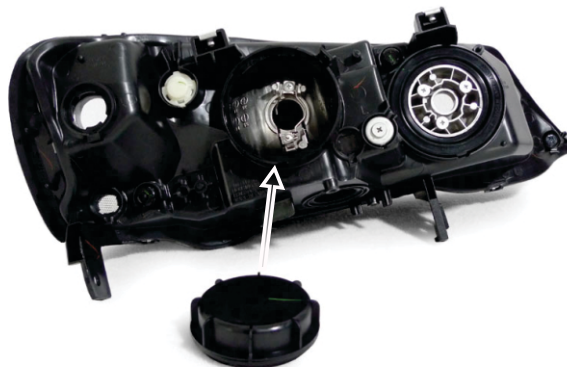
Separate low and high beam bulbs; When you can access the bulb from the back of the headlight without removing any caps or covers. Wiring for the bulb is visible and accessible outside of the housing.



PROCEED TO PAGE 4

INTERNAL LOW-BEAM

Separate low and high beam bulbs; When you must first remove a cap (generally plastic) to access the bulb. Inside the housing, there is wiring going to the bulb.



PROCEED TO PAGE 6

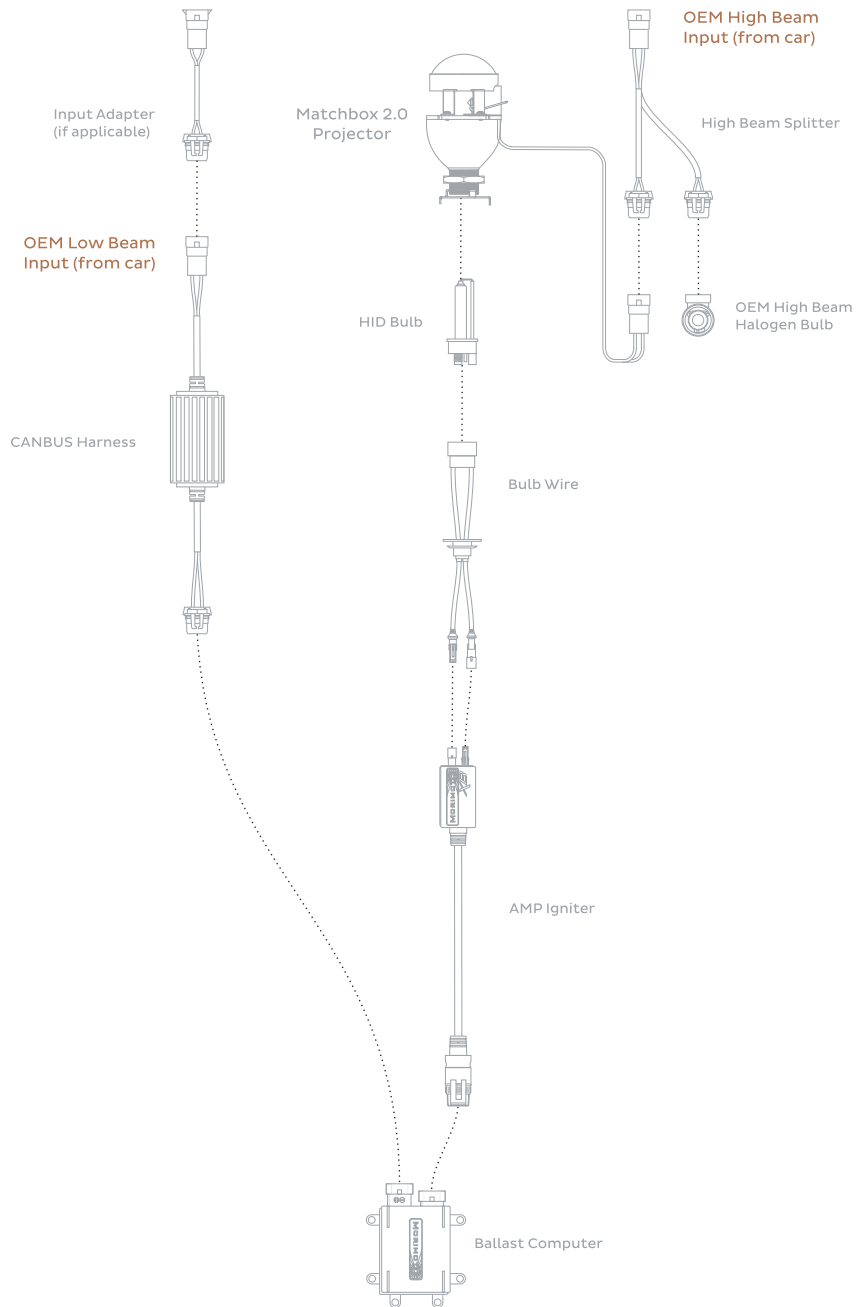
DUAL FILAMENT

Shared low/high beam bulb; You can access the bulb from the back of the headlight without removing any caps or covers. Wiring for the bulb is visible and accessible outside of the housing.

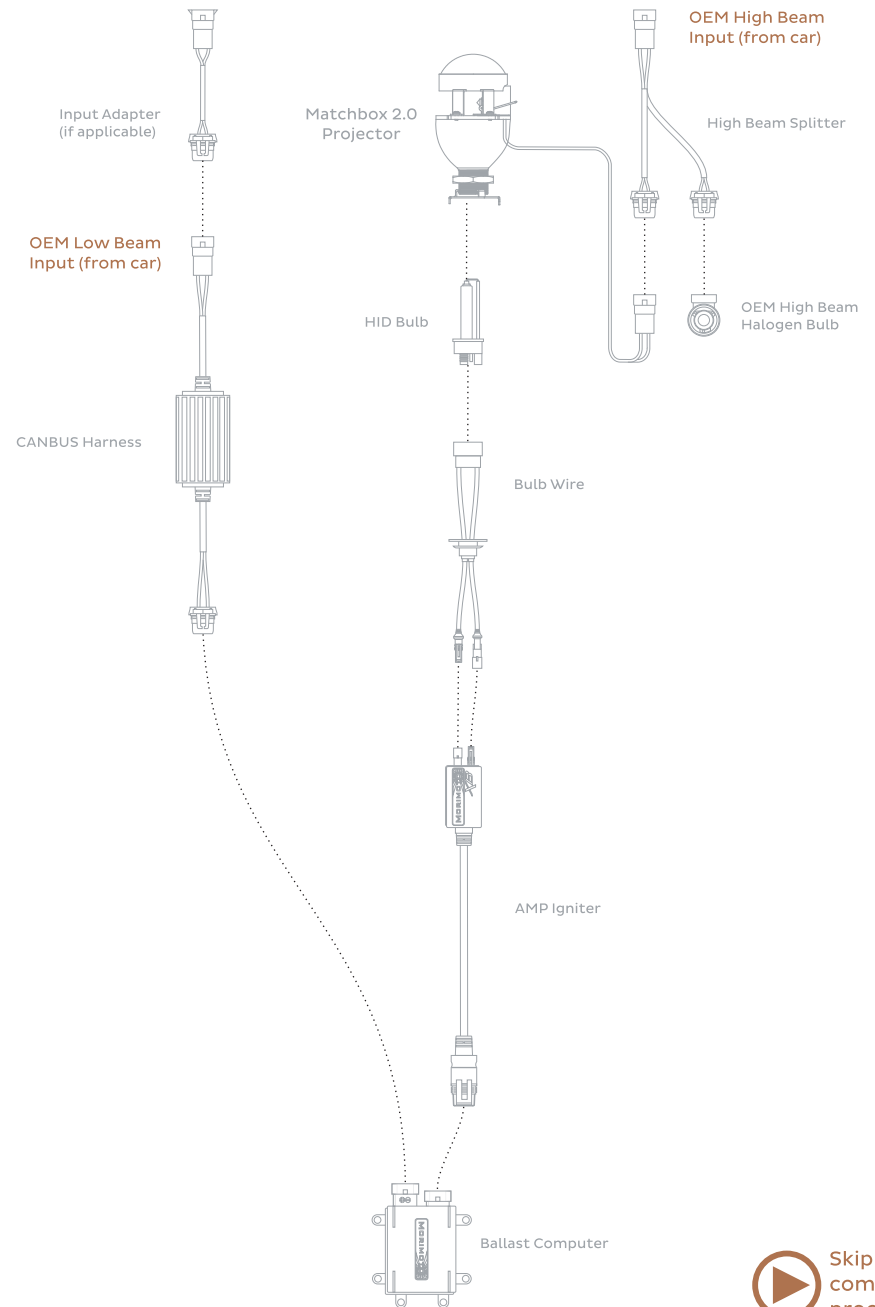


PROCEED TO PAGE 8

Right Side of Vehicle



Left Side of Vehicle

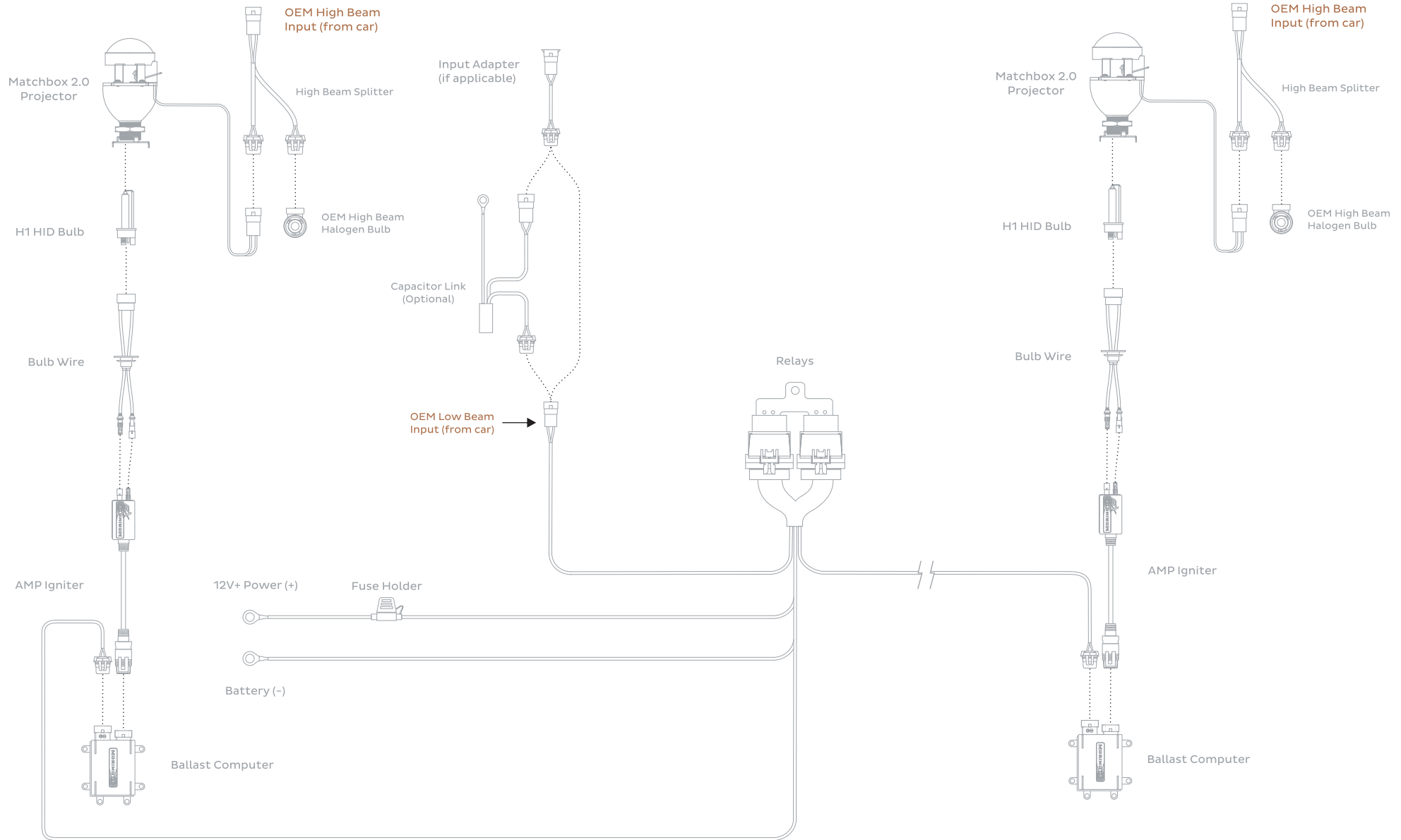


▶ Skip to Page 10 for component-specific procedures

EXTERNALLY-WIRED W/ HD RELAY HARNESS

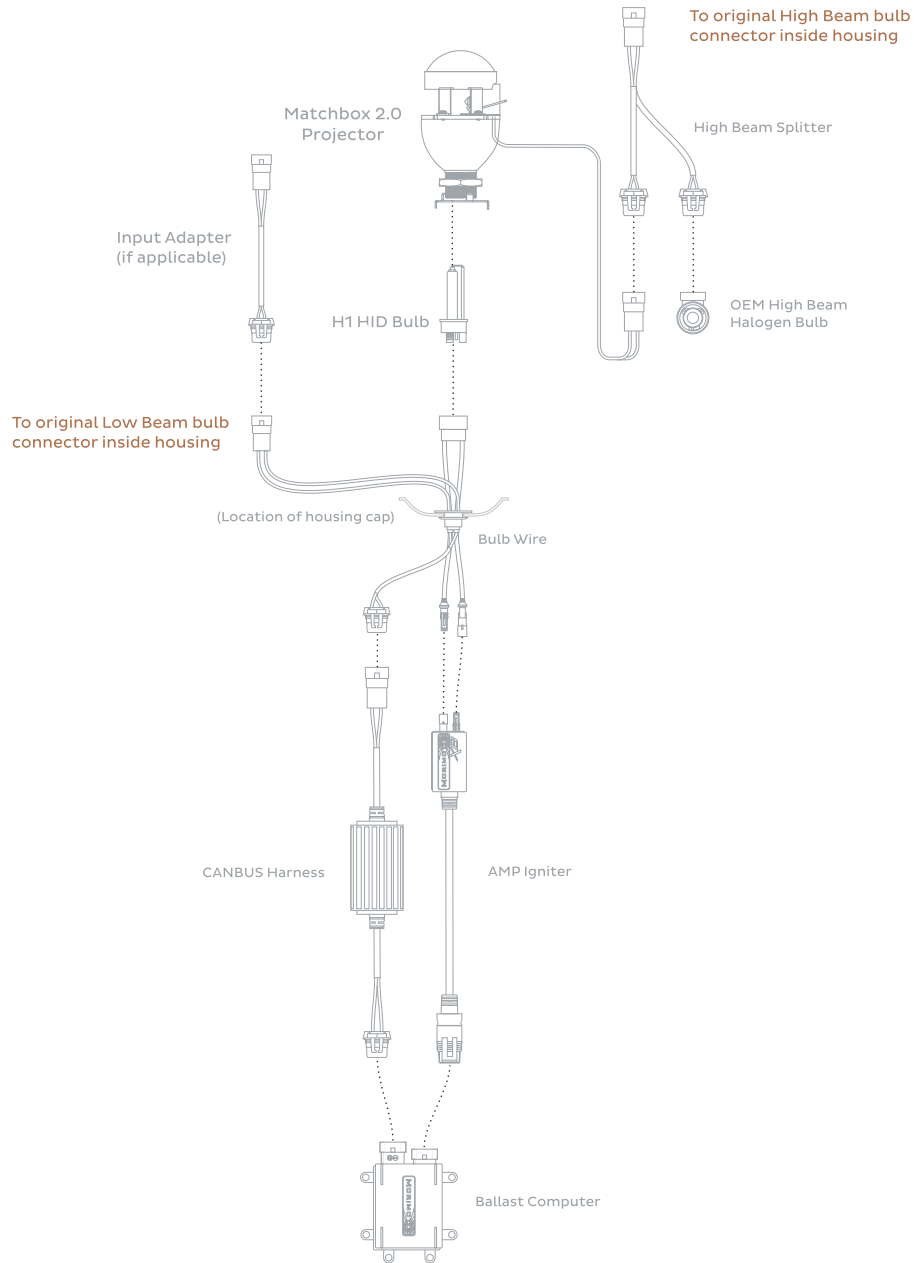
Side of vehicle
closer to battery

Side of vehicle
further from battery

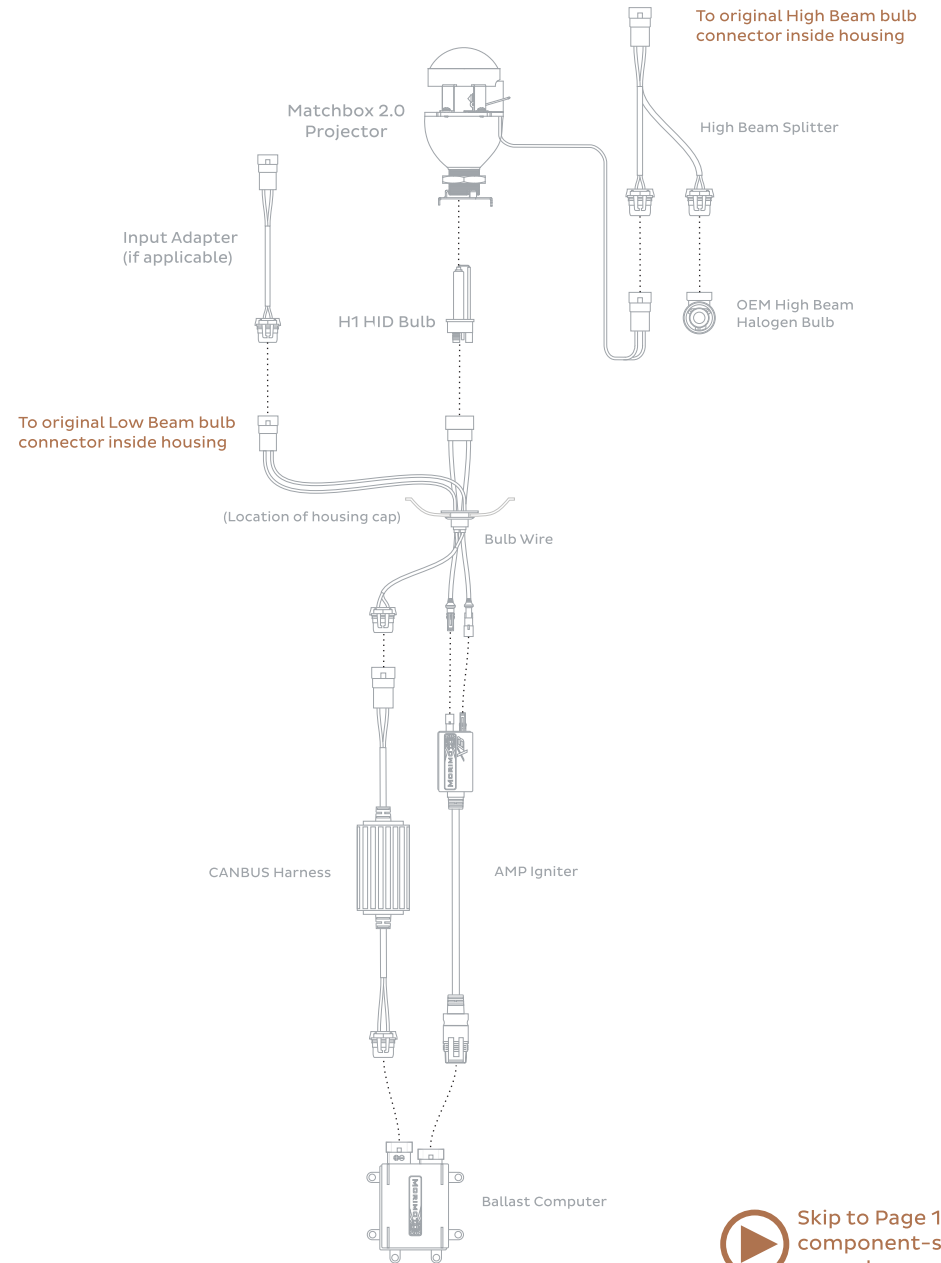


 Skip to Page 10 for component-specific procedures

Right Side of Vehicle

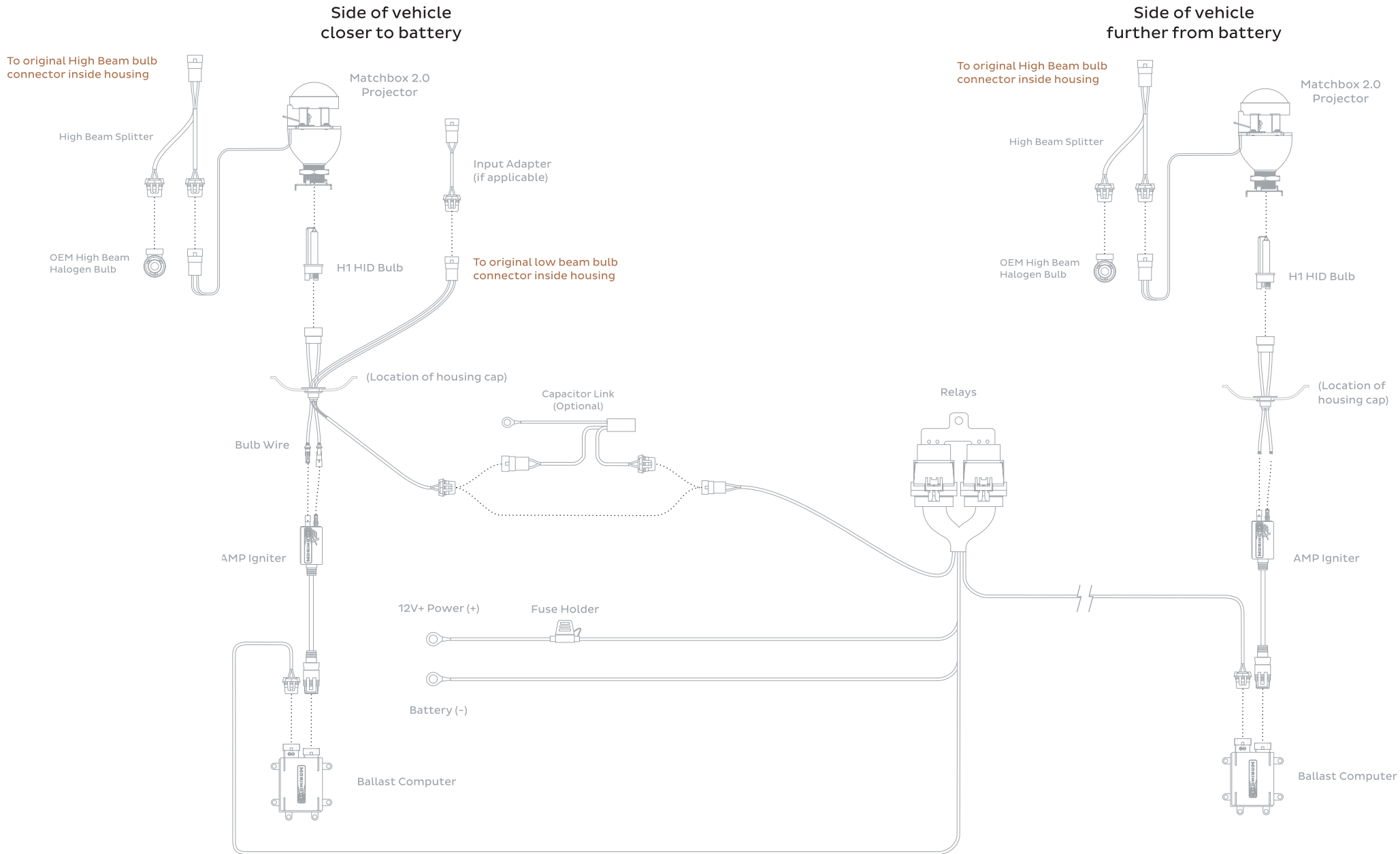


Left Side of Vehicle



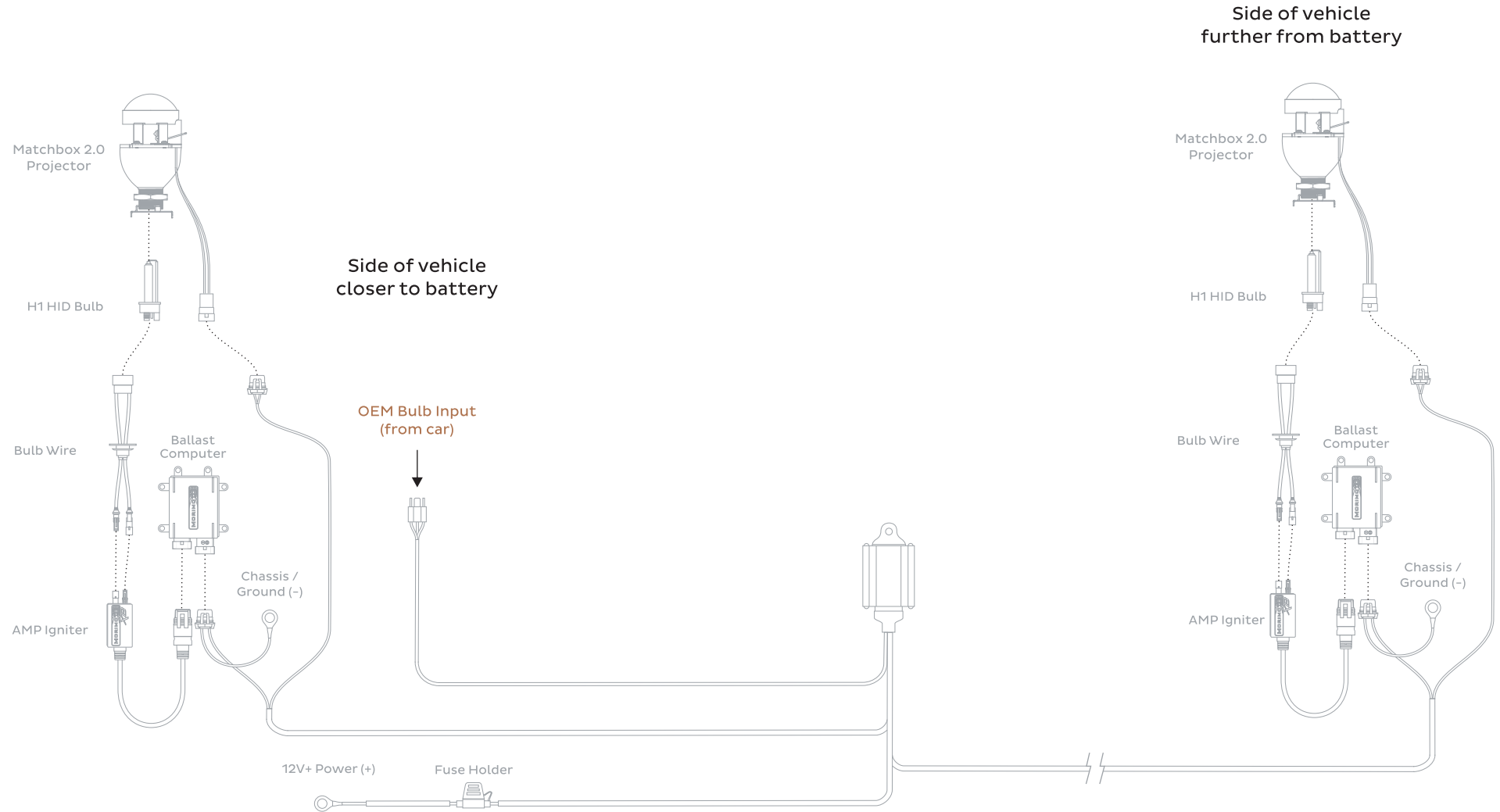
 Skip to Page 10 for component-specific procedures

INTERNALLY-WIRED W/ HD RELAY HARNESS



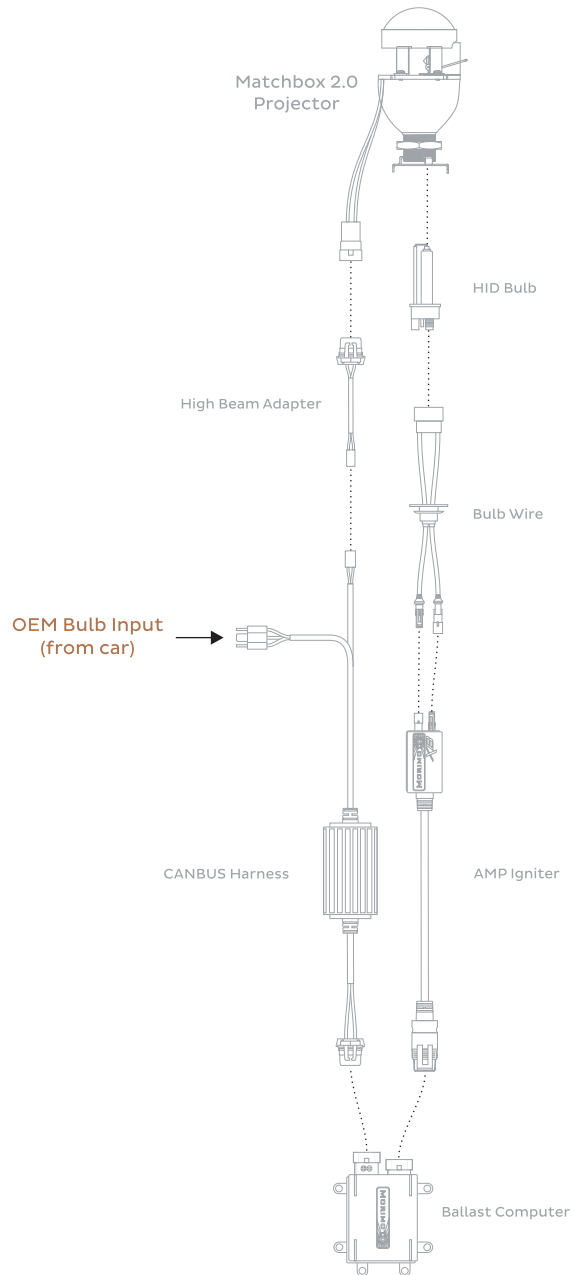
 Skip to Page 10 for component-specific procedures

DUAL FILAMENT WITH MOTOCONTROL HARNESS

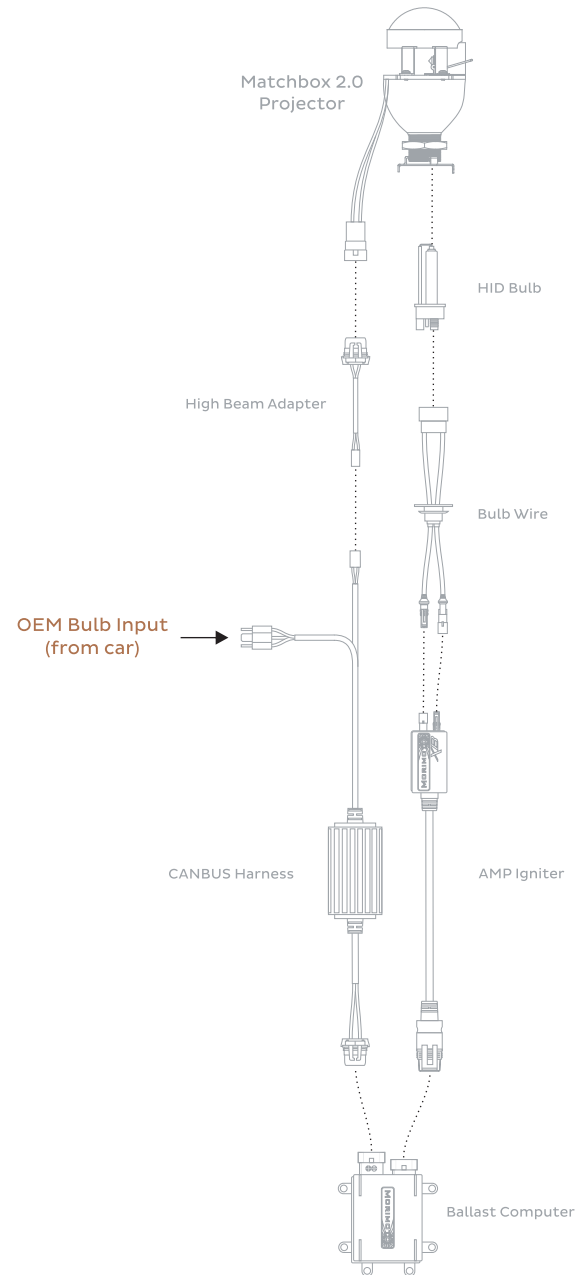


 Skip to Page 10 for component-specific procedures

Right Side of Vehicle



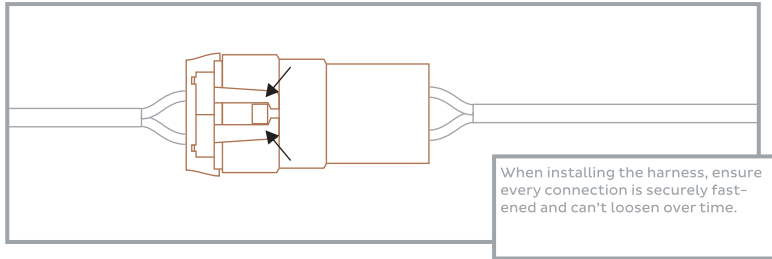
Left Side of Vehicle



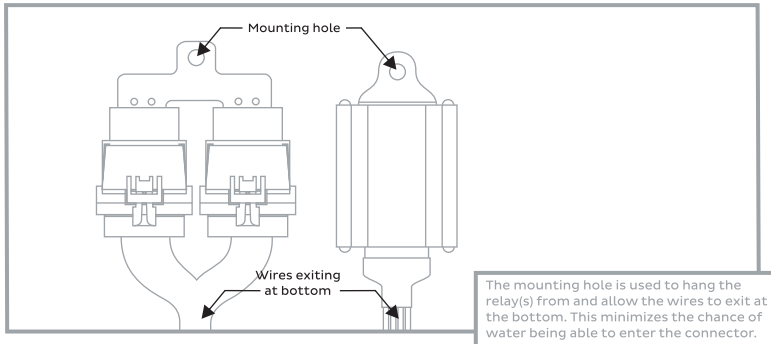
 Skip to Page 10 for component-specific procedures

HARNESS INSTALLATION

SPECIAL NOTE: ALL HARNESSES



SPECIAL NOTE: HD RELAY AND MOTOCONTROL HARNESSES



PROJECTOR INSTALLATION

HARDWARE CONTENTS



1x H4 Silicone Grommet



1x H7 Silicone Grommet



1x H4 Adapter Plate



1x H7 Adapter Plate



1x 9006 Male Connector



1x Bulb Retaining Clip



1x Hex Lock Nut



1x Three-Prong Bulb Holder



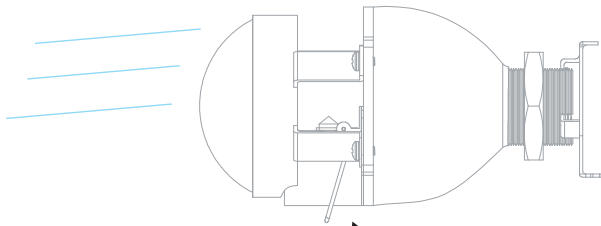
3x Bulb Holder Screws



2x 9006 Socket Grommets

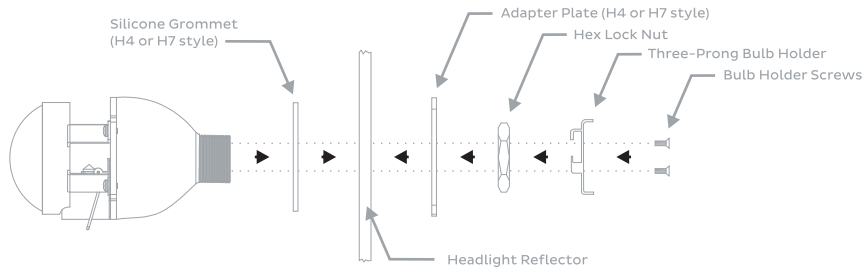
BULB INSTALLATION

SPECIAL INSTALLATION NOTE

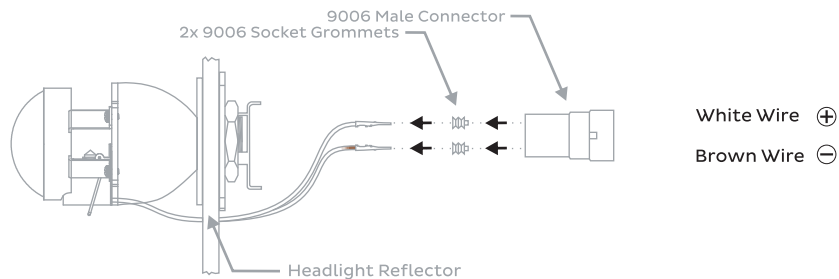


Mount projector rotationally level and with the solenoid and light cutoff shield on the bottom for proper light output

HARDWARE SCHEMATIC



SOLENOID WIRING SCHEMATIC

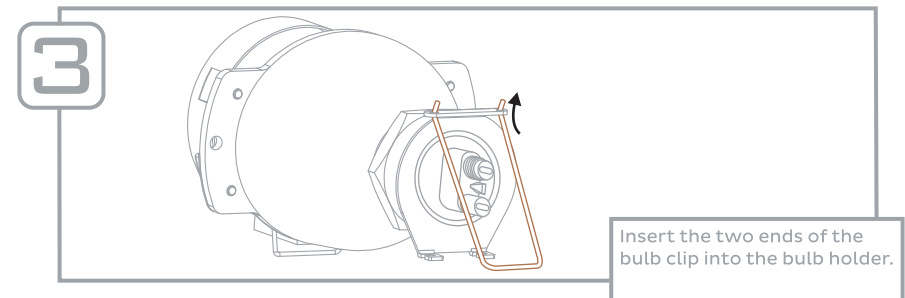
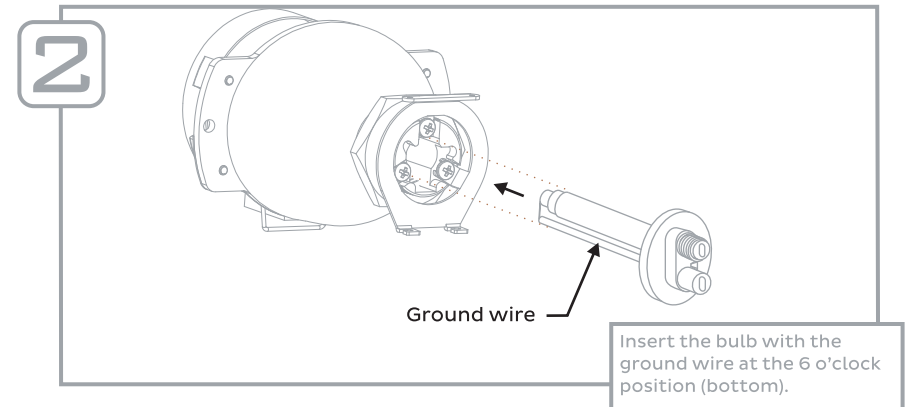
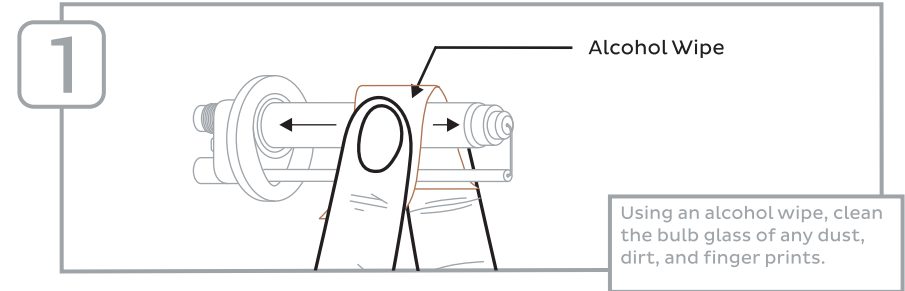


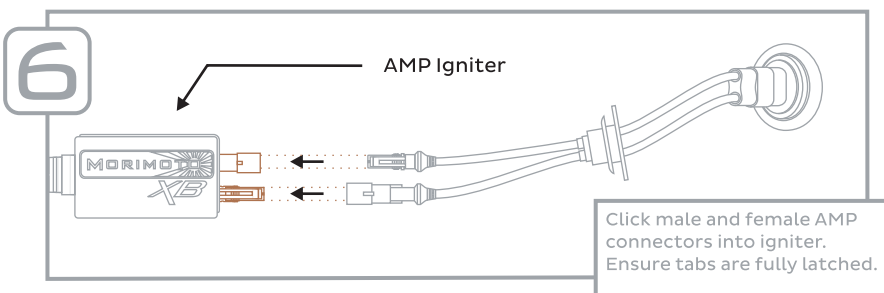
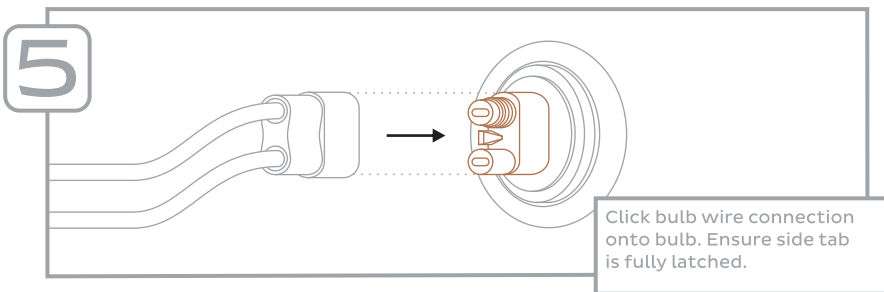
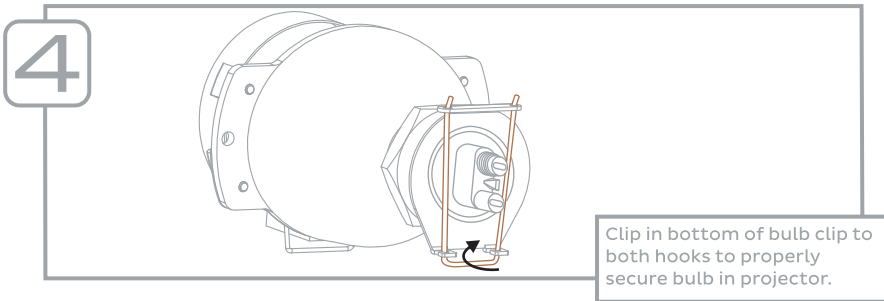
CAUTION: HOT!



HANDLE ONLY WITH
BLACK PLASTIC BASE

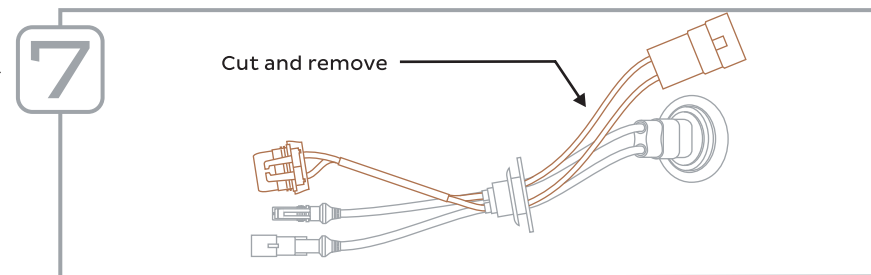
STEP BY STEP



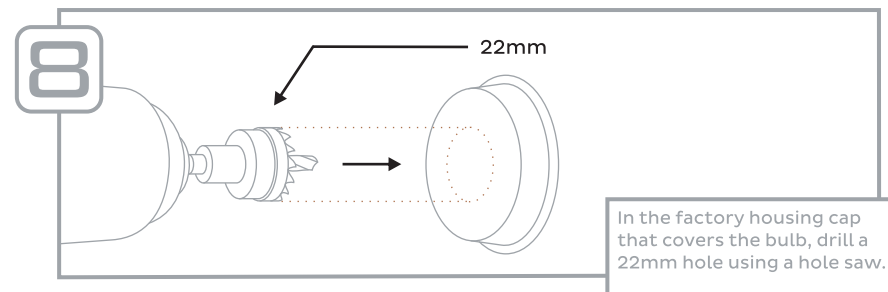
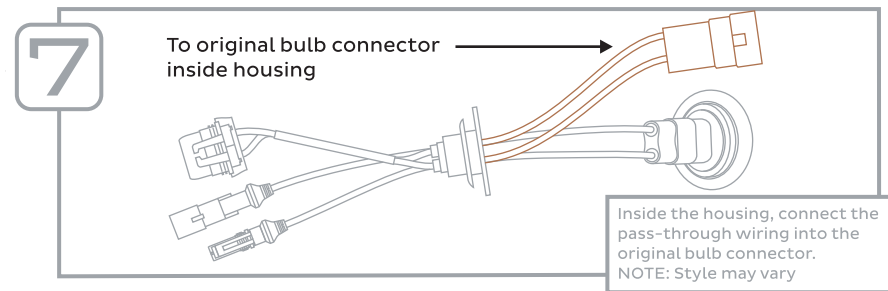


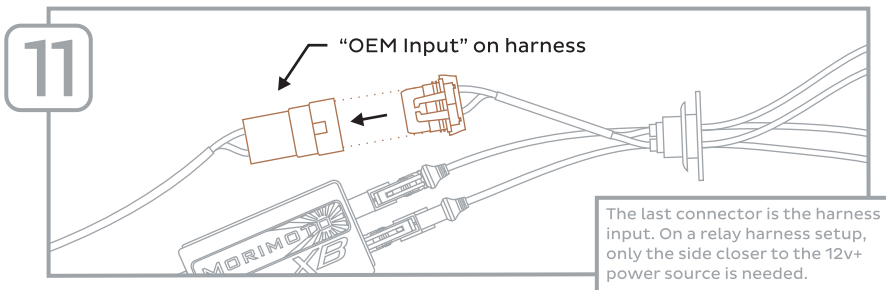
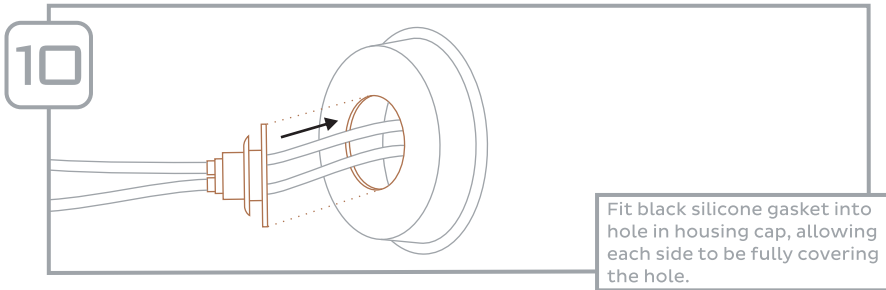
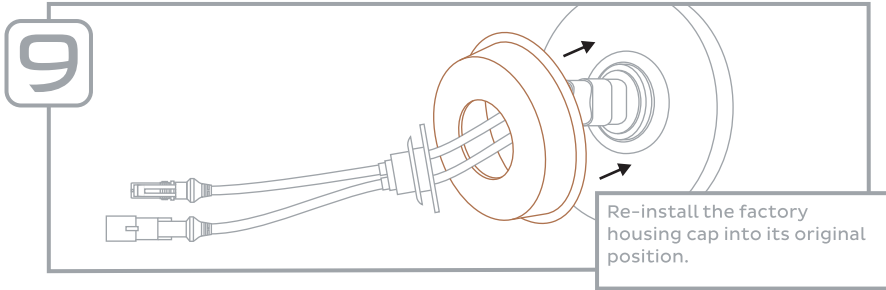
 Proceed to either **INTERNALLY** or **EXTERNALLY** step #7

STEP BY STEP - EXTERNALLY-WIRED



STEP BY STEP - INTERNALLY WIRED





BALLAST INSTALLATION

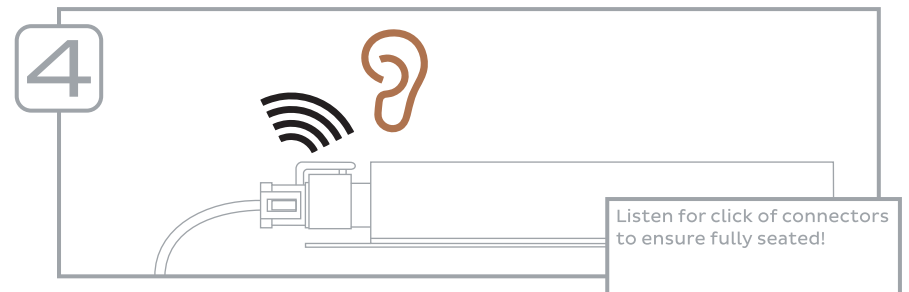
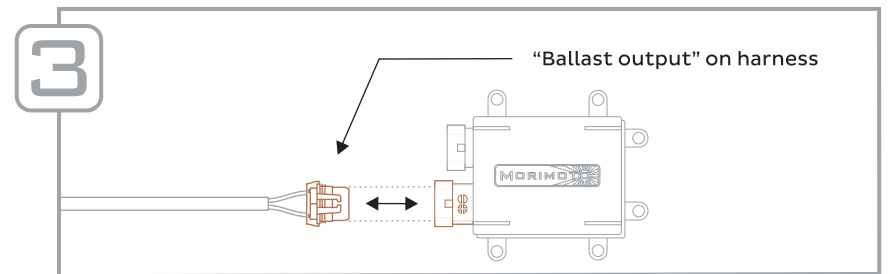
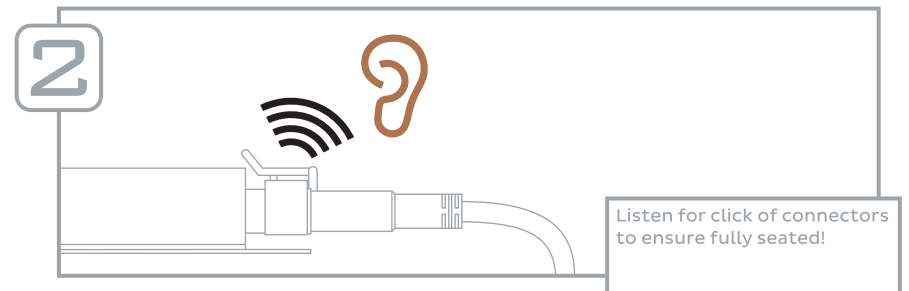
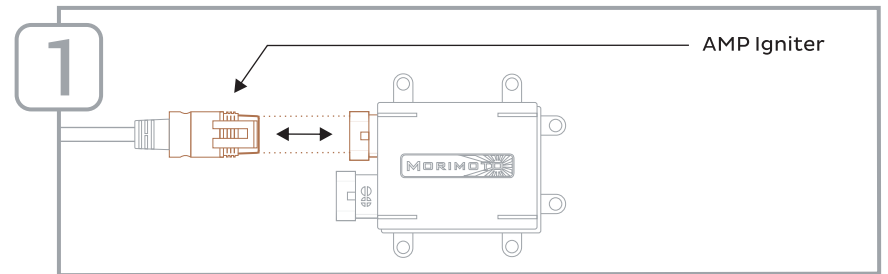


DO NOT IGNITE UNTIL FULLY CONNECTED!



WATERPROOF

SCHEMATIC



5 Recommended mounting:

Do not mount ballast with connectors aimed upward!

XSB HALO INSTALLATION

12V

12VDC INPUT



DO NOT CUT!



DO NOT GLUE!

1

Using a small flathead screw driver or paper clip, press the tabs holding the halo pins into the connector and remove the wiring from the connector.

2

Test-fit the halo on the shroud to see where it will be mounted.

3

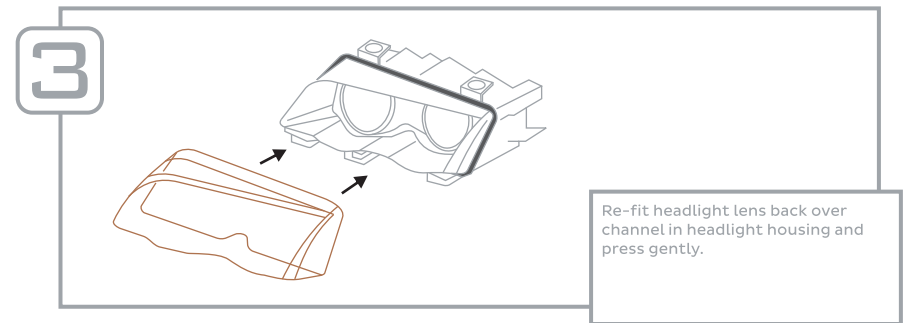
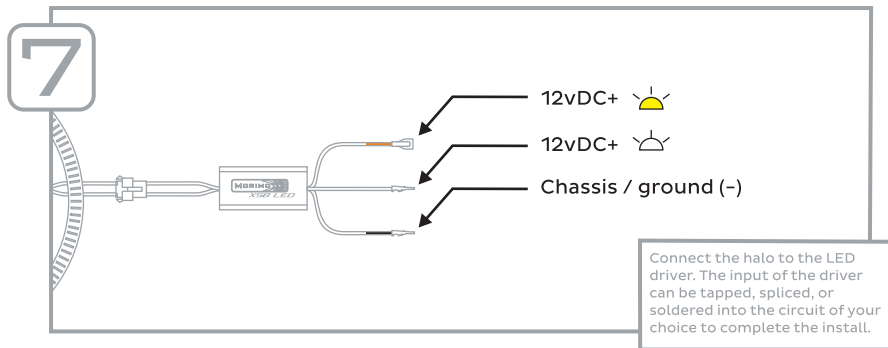
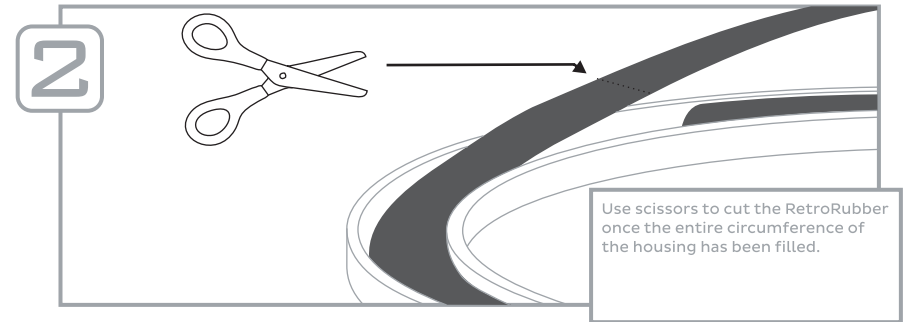
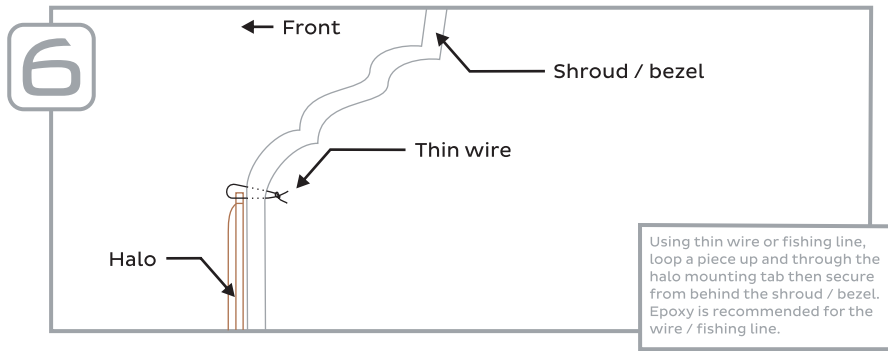
Using a 1mm drill bit, make one hole for each mounting tab, then another hole slightly outside of that for wire to feed up and over the mounting hole.

4

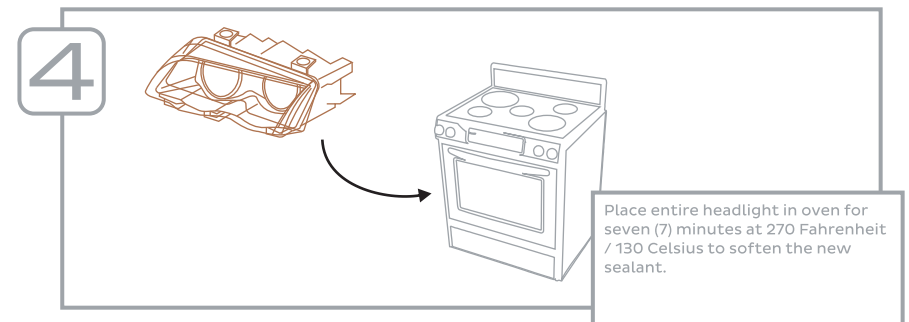
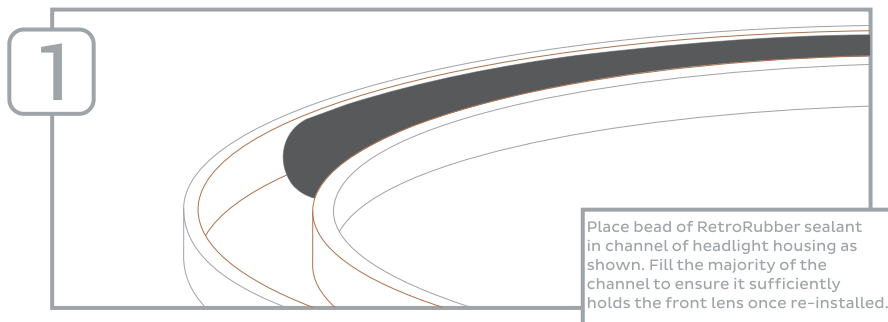
In the desired location, drill a 4mm hole for the wiring to pass through the shroud/bezel.

5

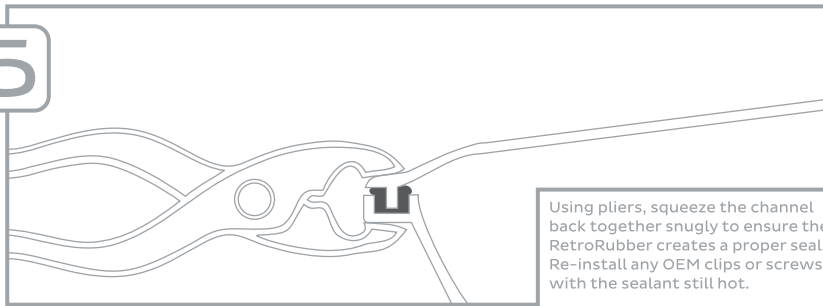
Feed the wiring through the 5mm hole in the shroud / bezel and re-insert the pins into the connector, ensuring proper orientation of the wire colors.



USING RETRORUBBER SEALANT

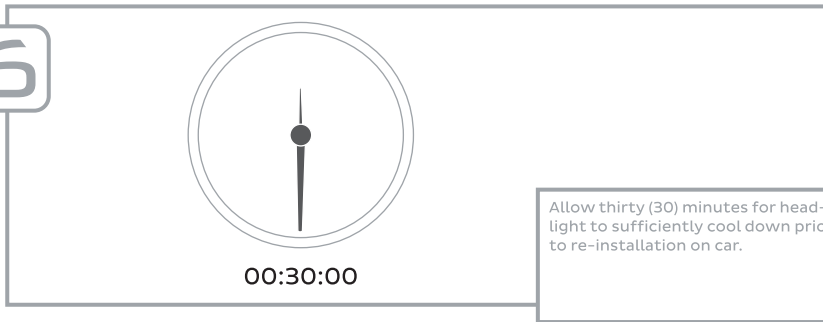


5



Using pliers, squeeze the channel back together snugly to ensure the RetroRubber creates a proper seal. Re-install any OEM clips or screws with the sealant still hot.

6



Allow thirty (30) minutes for headlight to sufficiently cool down prior to re-installation on car.

-END-