

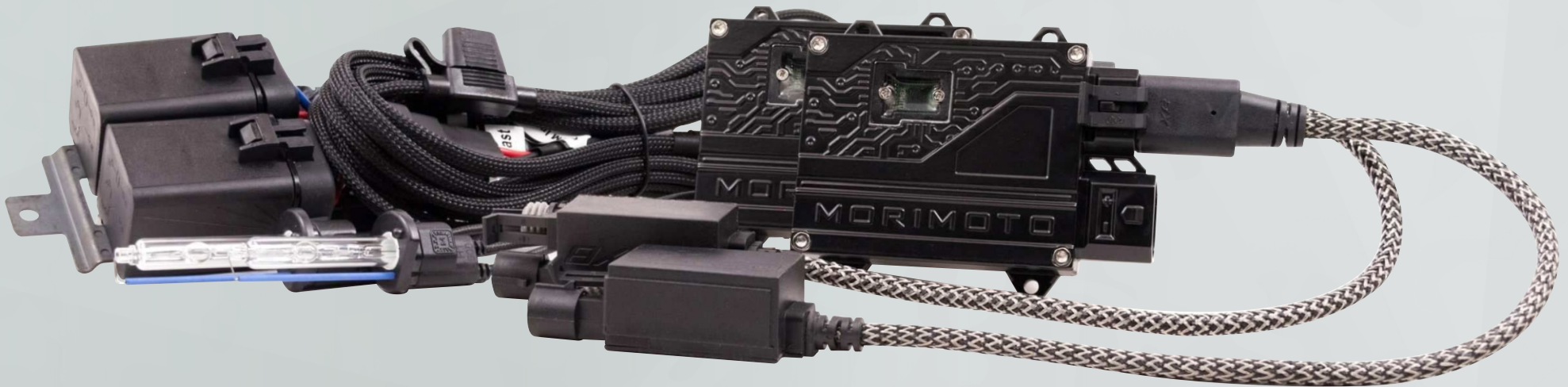

THE AUTOMOTIVE LIGHTING BENCHMARK

# ELITE HID SYSTEM INSTALL GUIDE

WARNING: By reading this document, you agree it is only to be used as an educational guide. Morimoto Lighting nor its dealers make guarantees on any finished results, nor are they to be held responsible for any damage, misuse, or personal injuries. If you are unable to clearly understand and adapt the information below, professional installation is recommended.



# PARTS IDENTIFICATION

## STANDARD PARTS

2x BALLAST COMPUTERS

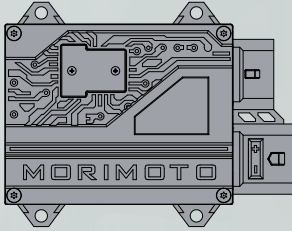

2x AMP IGNITERS

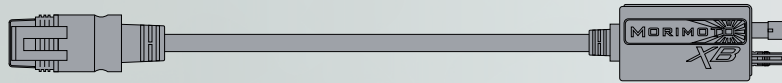

2x HID BULBS  
(BASE STYLE MAY VARY)

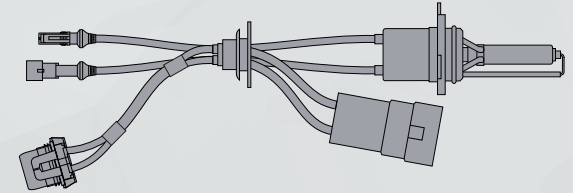

## HARNESS OPTIONS

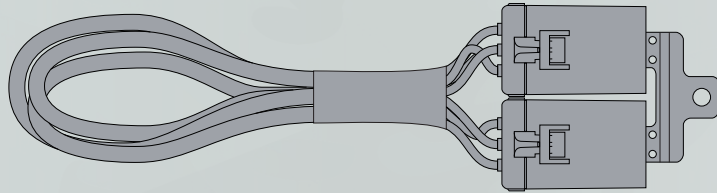

HD RELAY HARNESS  
(IDEAL FOR MOST VEHICLES)



STANDALONE CANBUS HARNESSES  
(IDEAL FOR ELIMINATING "BULB OUT" ERRORS)

## ADDITIONAL PARTS

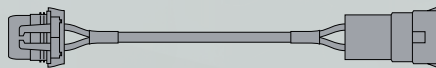

HARNESS INPUT ADAPTER  
(INCLUDED BASED ON BULB SIZE; STYLE MAY VARY)

## OPTIONAL PARTS

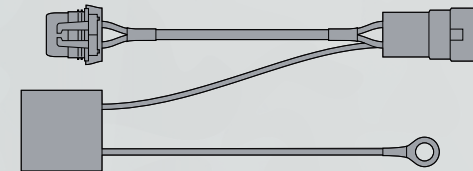

ANTI-FLICKER CAPACITOR LINK

# INSTALLATION TYPE IDENTIFICATION



NOTE: There are two installation types of HID systems: EXTERNALLY and INTERNALLY wired. This guide covers both types.

## EXTERNALLY-WIRED HEADLIGHTS

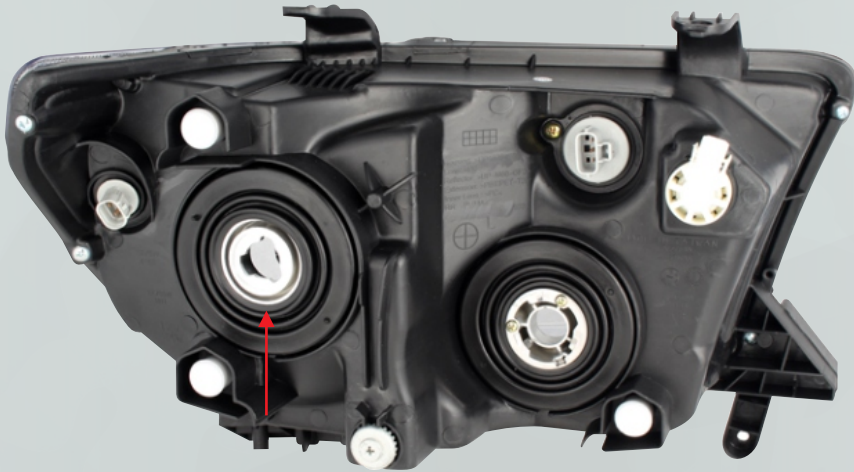

Your headlights are externally wired when you can access the bulb from the back of the headlight without removing any caps or covers. Wiring for the bulb is visible and accessible outside of the housing.

SKIP TO PAGE 4 FOR DIAGRAMS

## INTERNALLY-WIRED HEADLIGHTS

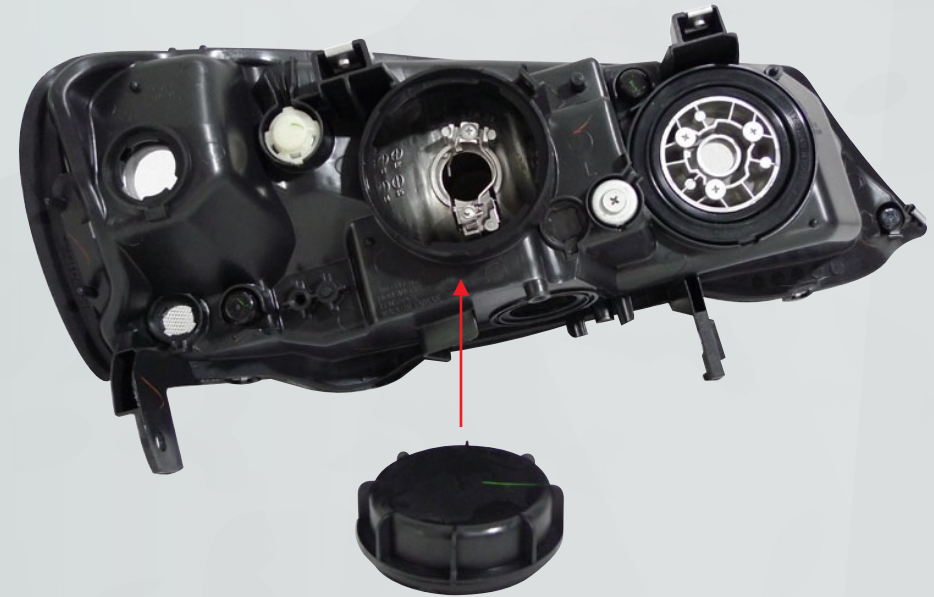

Your headlights are internally wired when you must first remove a cap (generally plastic) to access the bulb. Inside the housing, there is wiring going to the bulb.

SKIP TO PAGE 6 FOR DIAGRAMS



NOTE: System diagrams are to be used for reference purposes only. If you are unsure of the installation procedure for any single part, review that part's installation procedure prior to proceeding.

EXTERNALLY-WIRED HEADLIGHT DIAGRAMS:	
WITH STANDALONE CANBUS HARNESSSES	P. 4
WITH HD RELAY HARNESS	P. 5
INTERNALLY-WIRED HEADLIGHT DIAGRAMS:	
WITH STANDALONE CANBUS HARNESSSES	P. 6
WITH HD RELAY HARNESS	P. 7
PRODUCT INSTALLATION NOTES:	
BALLAST COMPUTERS / IGNITERS	P. 8
HID BULBS	P. 8
BASIC TROUBLESHOOTING TIPS	P. 9

## EXTERNALLY-WIRED HEADLIGHT DIAGRAMS

### EXTERNALLY-WIRED HEADLIGHTS WITH STANDALONE CANBUS HARNESSSES

! THIS SCHEMATIC IS MIRRORED ON BOTH SIDES OF VEHICLE

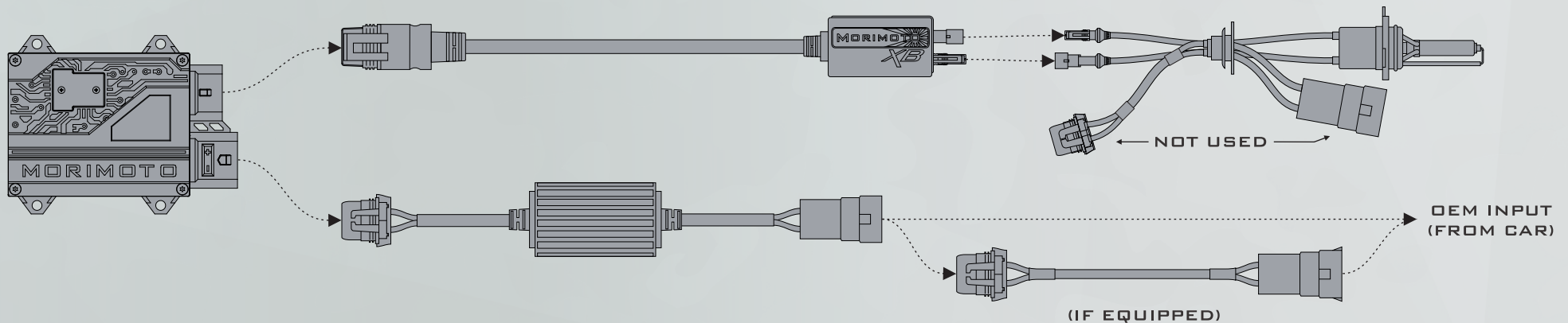

! SKIP TO PAGE 8 FOR PRODUCT INSTALLATION NOTES

# EXTERNALLY-WIRED HEADLIGHTS WITH HD RELAY HARNESS

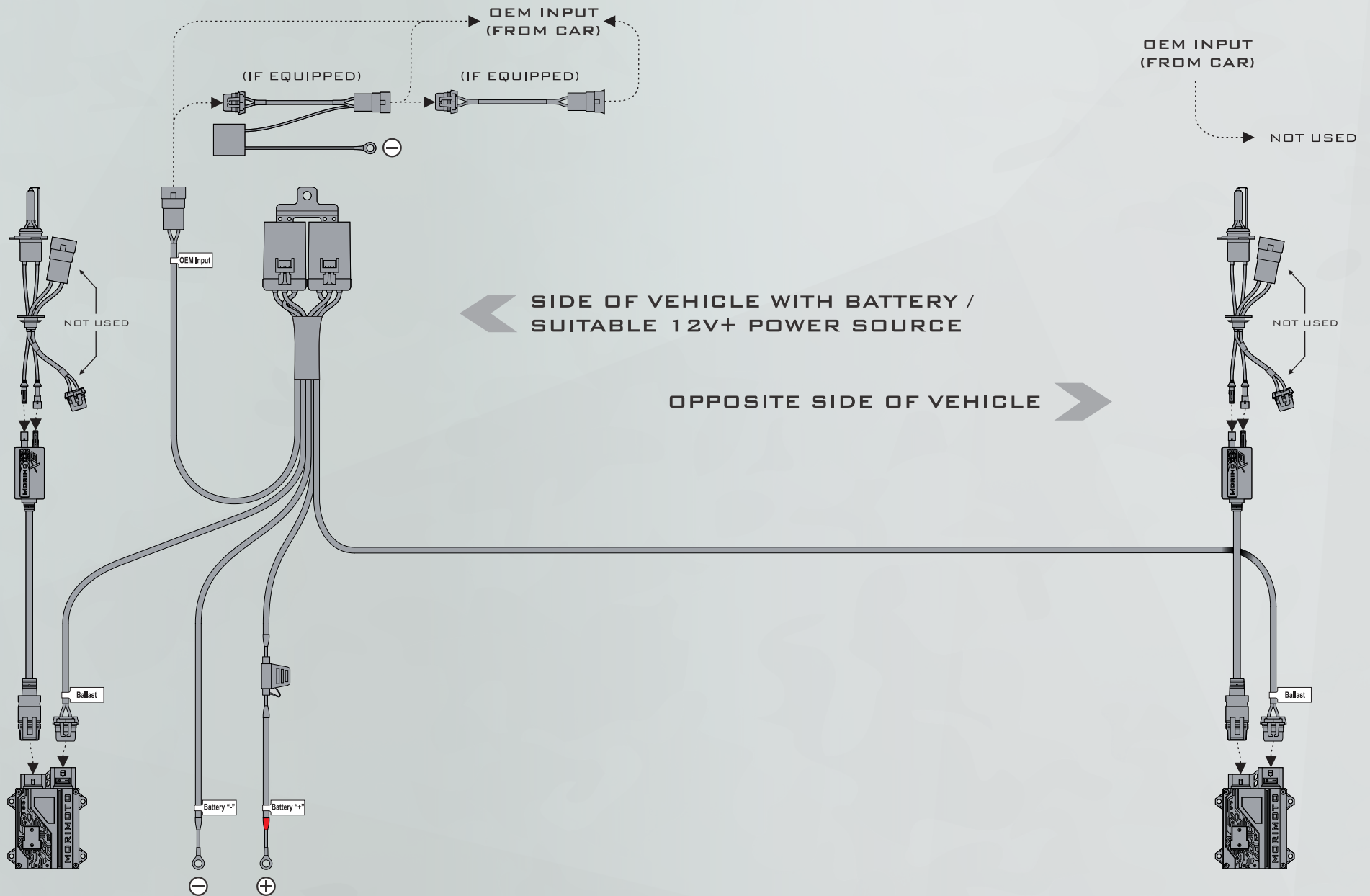

! SKIP TO PAGE 8 FOR PRODUCT INSTALLATION NOTES

# INTERNALLY-WIRED HEADLIGHT DIAGRAMS

## INTERNALLY-WIRED HEADLIGHTS WITH STANDALONE CANBUS HARNESSSES

! THIS SCHEMATIC IS MIRRORED ON BOTH SIDES OF VEHICLE

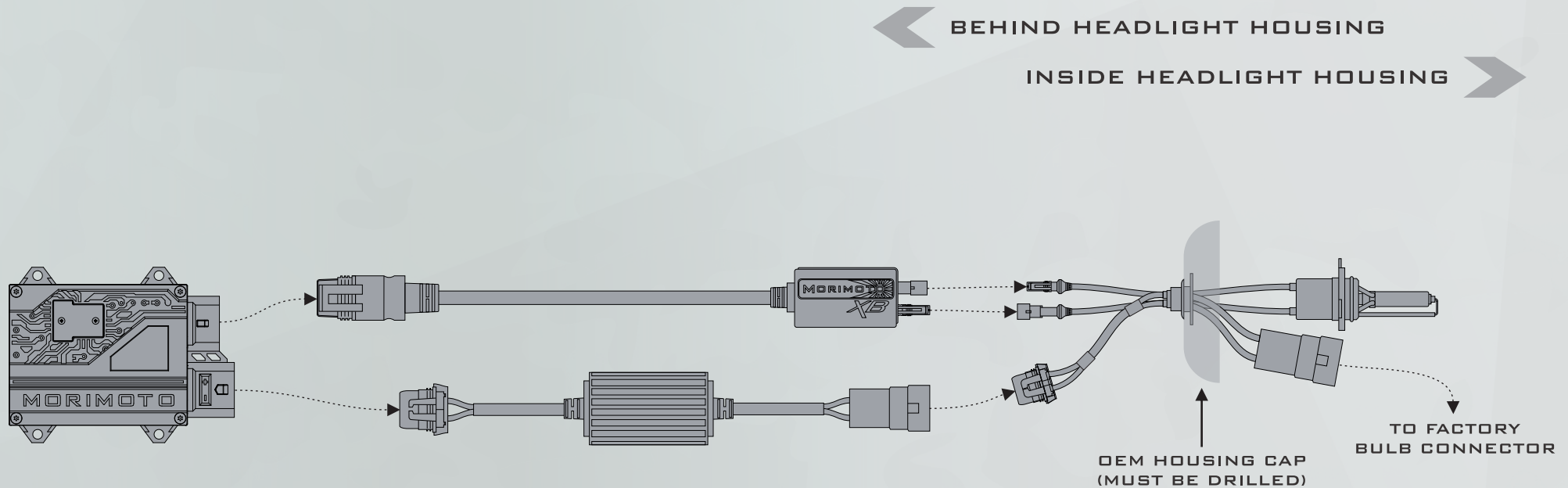

! SKIP TO PAGE 8 FOR PRODUCT INSTALLATION NOTES

# INTERNALLY-WIRED HEADLIGHTS WITH HD RELAY HARNESS

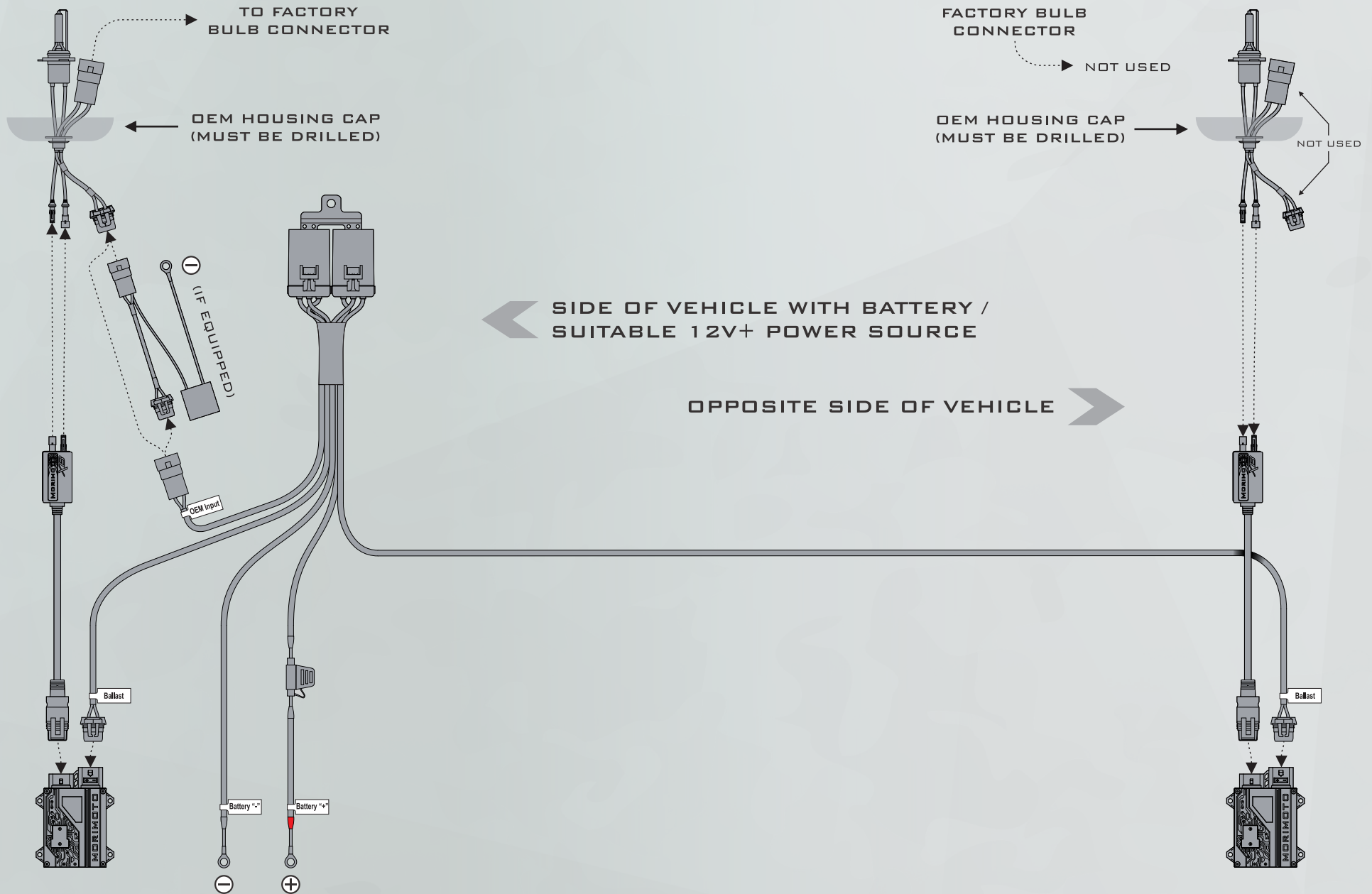

! SKIP TO PAGE 8 FOR PRODUCT INSTALLATION NOTES

# PRODUCT INSTALLATION NOTES

## BALLAST COMPUTERS / IGNITERS

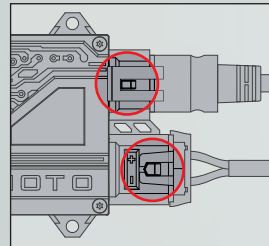
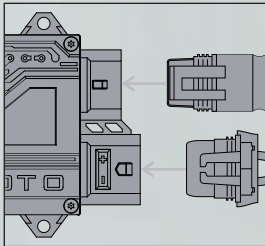

When connecting the ballast and igniter to their proper connections, ensure the latches of the connector surround the rear of the tabs to maintain proper connectivity.

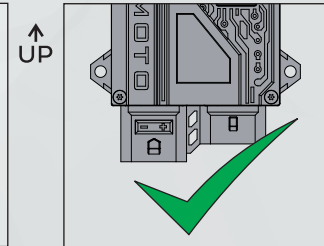
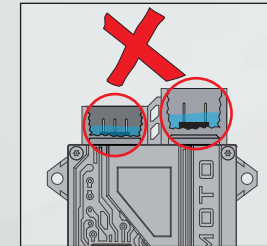

When mounting the ballast on the vehicle, do not mount it in an orientation that will allow water to naturally enter the connections and cause issues. Ideally, connectors should face downward (toward the ground) to reduce the risk.

## HID BULBS

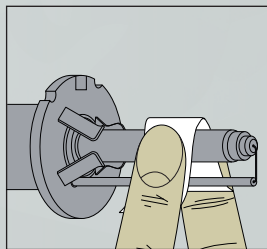

Using a new alcohol wipe, clean the bulb glass of any dust, dirt, or finger prints prior to installation.

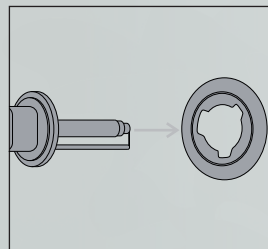

The new HID bulbs will install just like the original halogen bulbs they replace (in most applications).

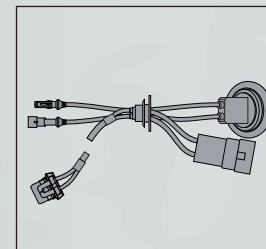

If noted as "not used" in your relevant install diagram, the pass-through wiring can be cut off and removed.

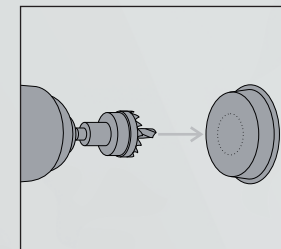

If the pass-through is needed, your factory housing cap must be drilled with a 20mm / 0.75" hole saw for the grommet to fit snugly in the cap.



# BASIC TROUBLESHOOTING TIPS

## ISSUE: NO ILLUMINATION

If neither headlight illuminates, it's likely due to one of the following issues that should be checked:

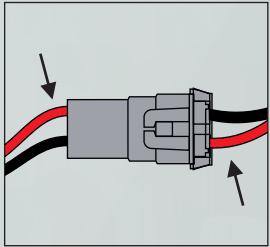

Input polarity is backward. Unplug input(s), flip over, and plug back in to reverse polarity and test again.

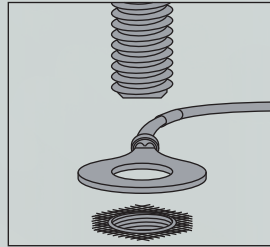

Lack of / poor grounding (Must go to bare metal and not piggyback other ground terminals.)

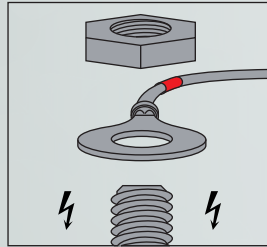

Ring terminal not fully secured to battery / sufficient 12V+ source.

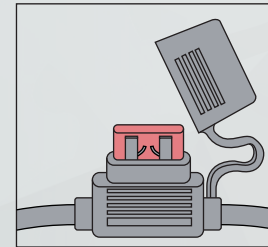

Blown harness fuse or poor fuse fitment in fuse holder.

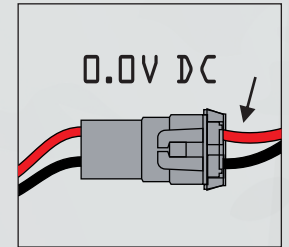

No power to headlight circuit from vehicle, due to fuse or other issue.

## ISSUE: ONLY ONE LIGHT ILLUMINATES

If only one headlight illuminates, it's unlikely a faulty part, but may be one of the following:

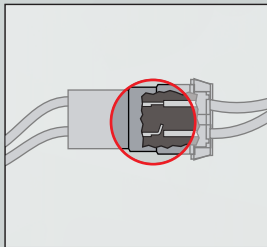

Bent pin in a connector, which would result in no power / ground being transferred to one side.

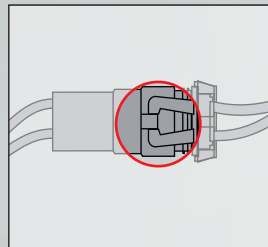

A connection is not fully inserted, so no power / ground can be transferred.