

Code: 08051561

# Double Sliding Gate Kit

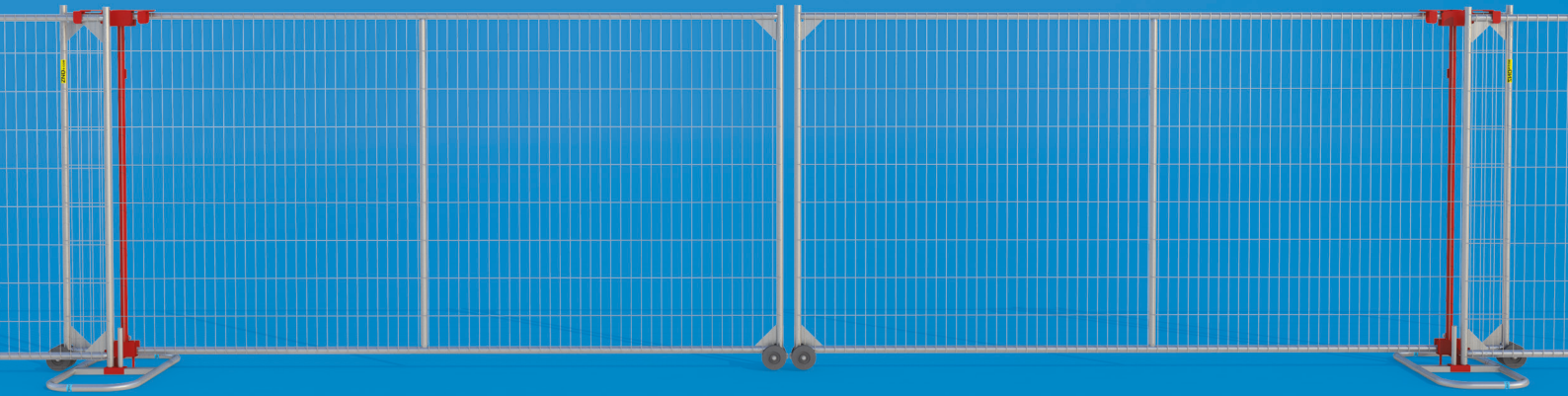

Last modified **September 2021**  
please check online to confirm  
you have the latest version

[www.znd.com](http://www.znd.com)

## Important Notes

Please note that this document is an assembly guide only and should be used simply to show how ZND products are assembled. The installation images contained within this document show the use of a proprietary ZND stabilizing system and this does not constitute a site specific design.



# Single Sliding Gate Kit

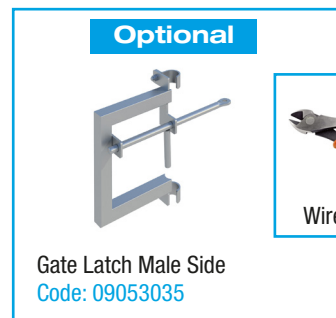
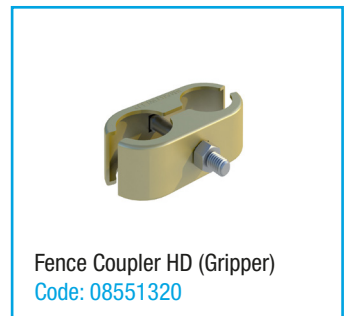
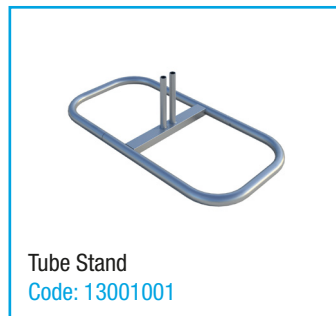
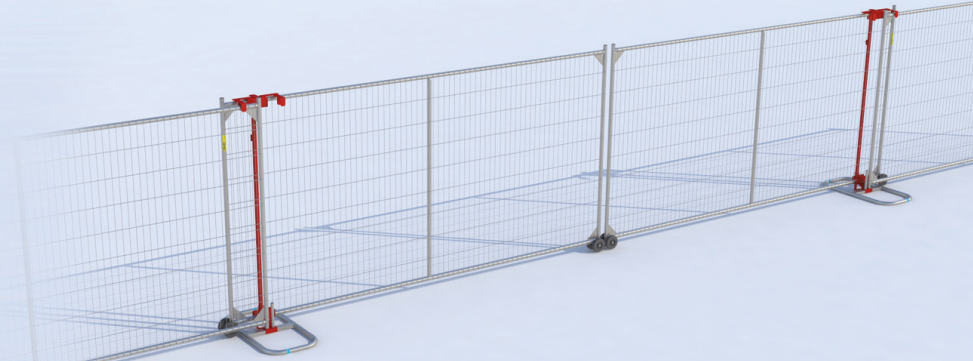

## Recommended for Safety

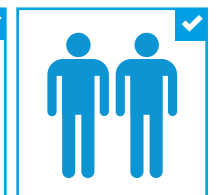

## Important Notes

Please note that this document is an assembly guide only and should be used simply to show how ZND products are assembled. The installation images contained within this document show the use of a proprietary ZND stabilizing system and this does not constitute a site specific design.

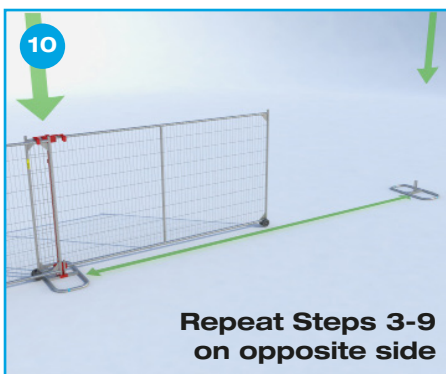
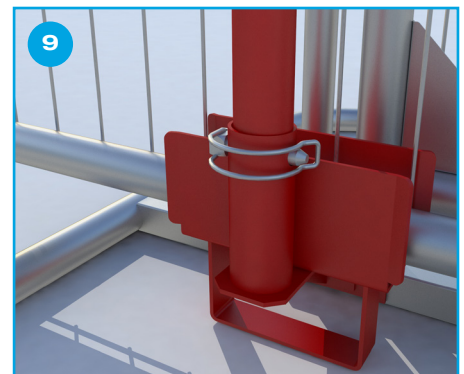
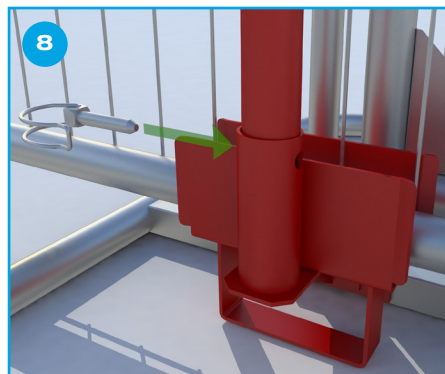
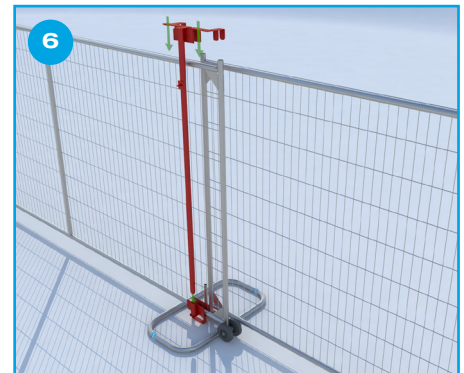
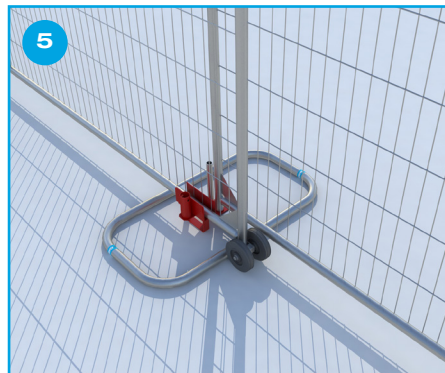
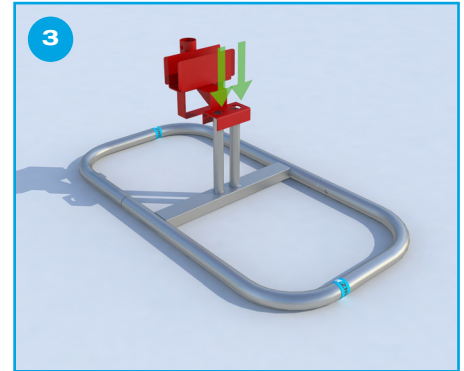
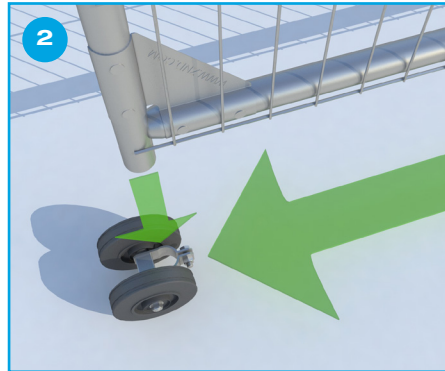

## Important Notes

Please note that this document is an assembly guide only and should be used simply to show how ZND products are assembled. The installation images contained within this document show the use of a proprietary ZND stabilizing system and this does not constitute a site specific design.



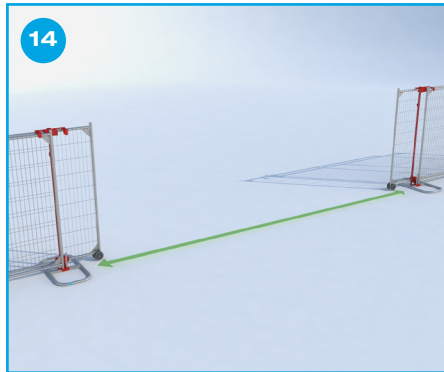
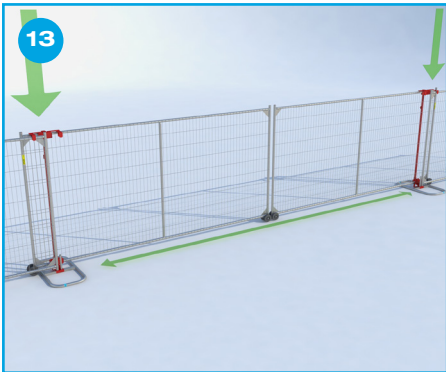

## Optional Addition of Gate Latch

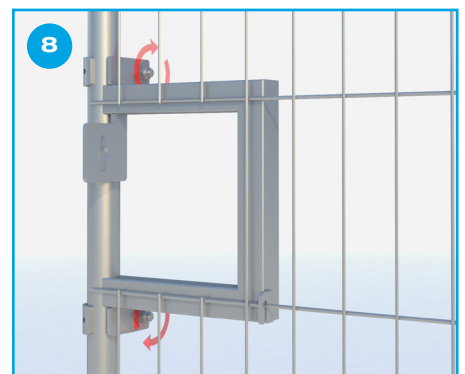
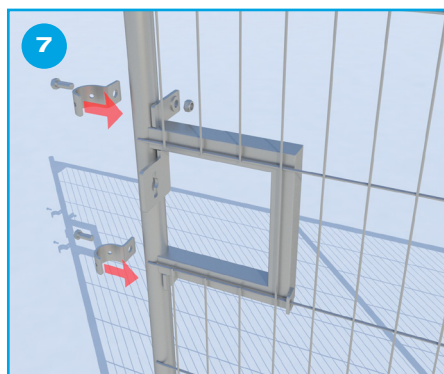
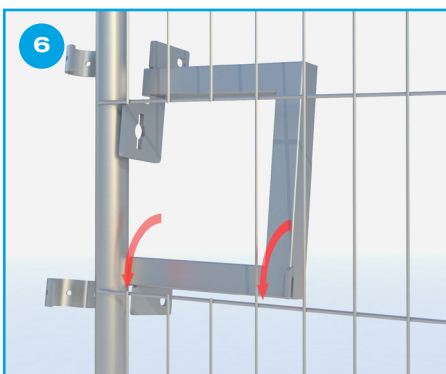
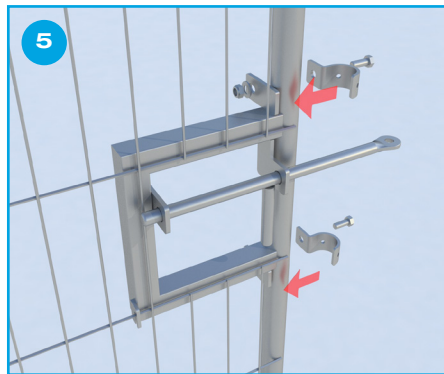
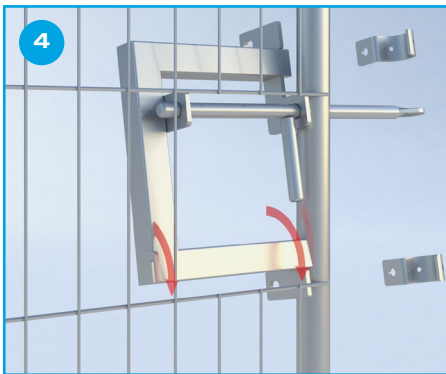
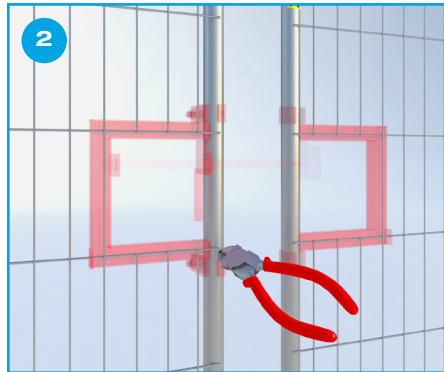
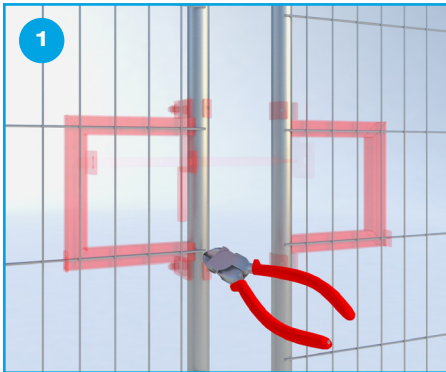

## Important Notes

Please note that this document is an assembly guide only and should be used simply to show how ZND products are assembled. The installation images contained within this document show the use of a proprietary ZND stabilizing system and this does not constitute a site specific design.



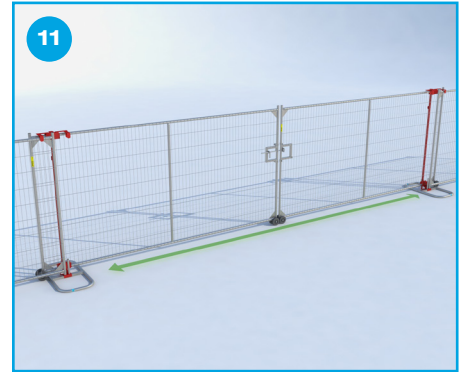
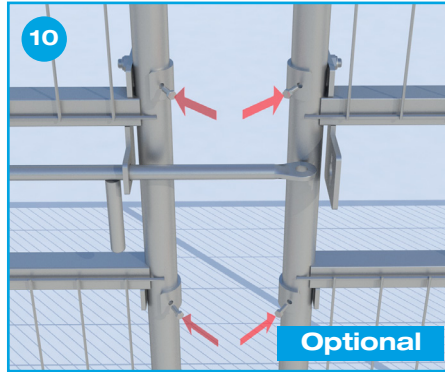
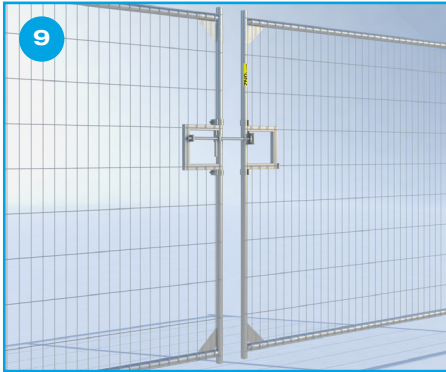

## Important Notes

Please note that this document is an assembly guide only and should be used simply to show how ZND products are assembled. The installation images contained within this document show the use of a proprietary ZND stabilizing system and this does not constitute a site specific design.

