

# Assembly Instructions

**WARNING: KEEP AWAY FROM FIRE/FLAME**  
**ADULT ASSEMBLY REQUIRED**

**Use of gloves recommended**

**Please be careful not to drag hands or fingers along the edges of the cardboard**

**Please remove all the excess cardboard from tabs/holes before assembly**

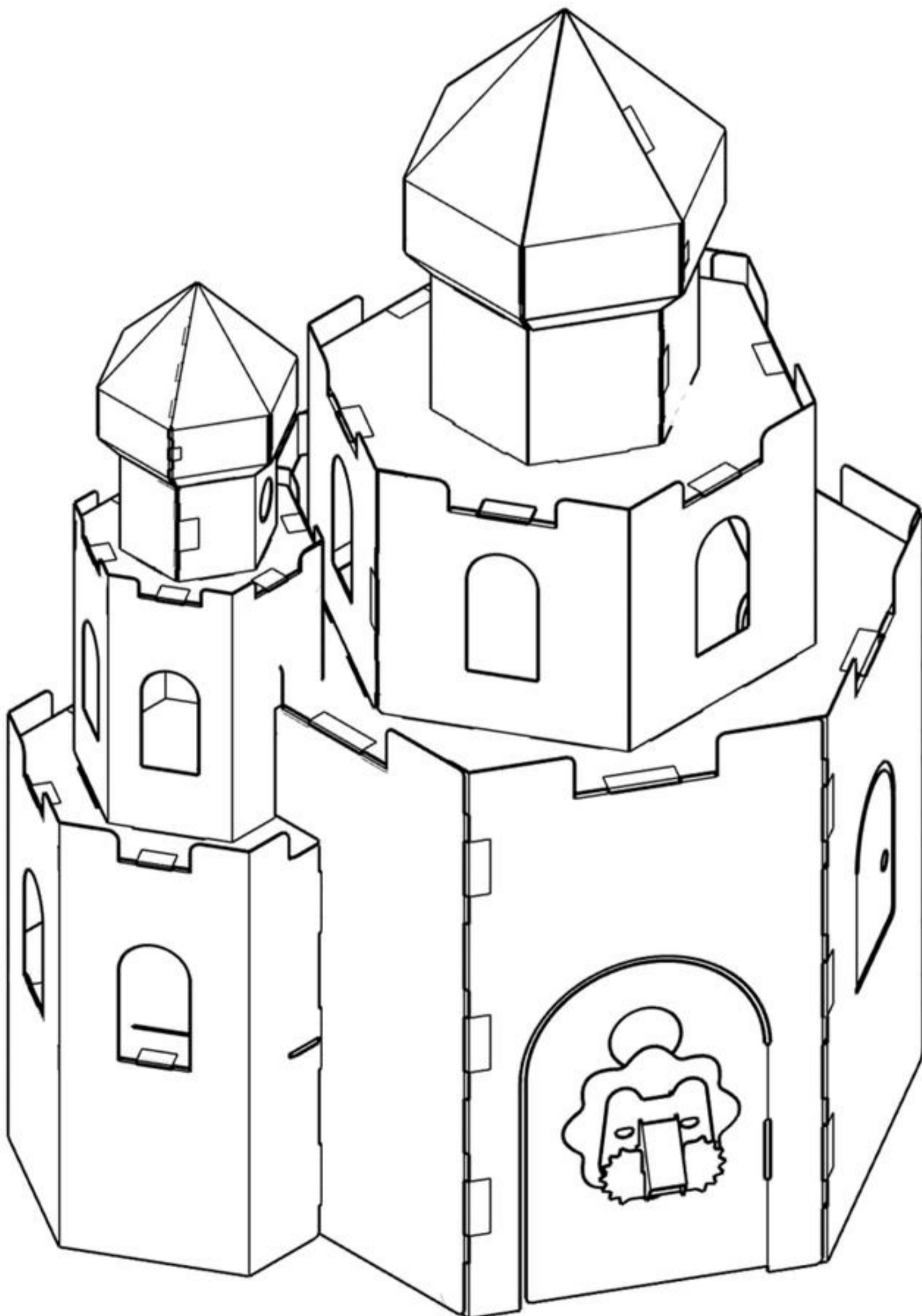

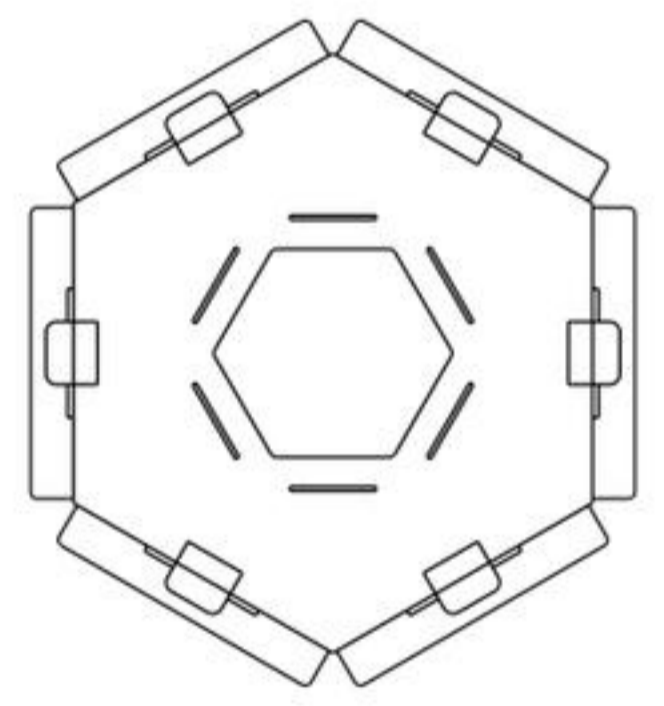
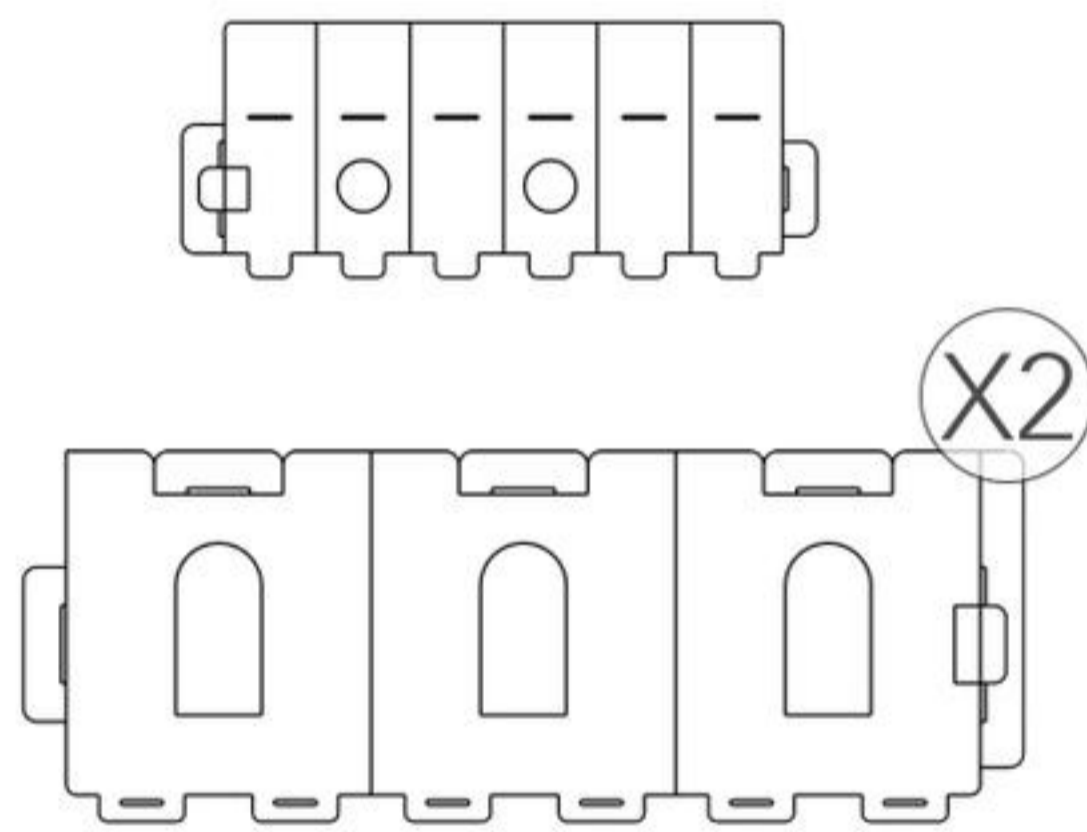
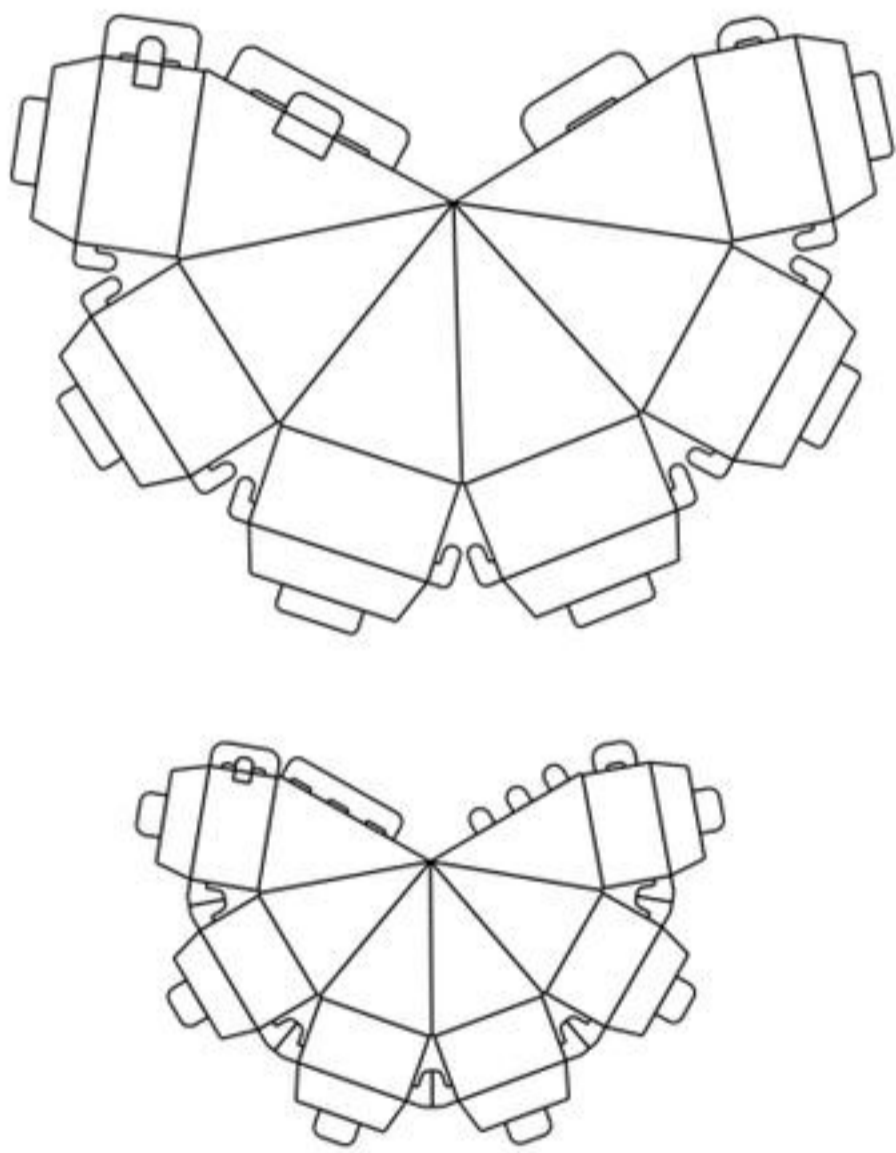
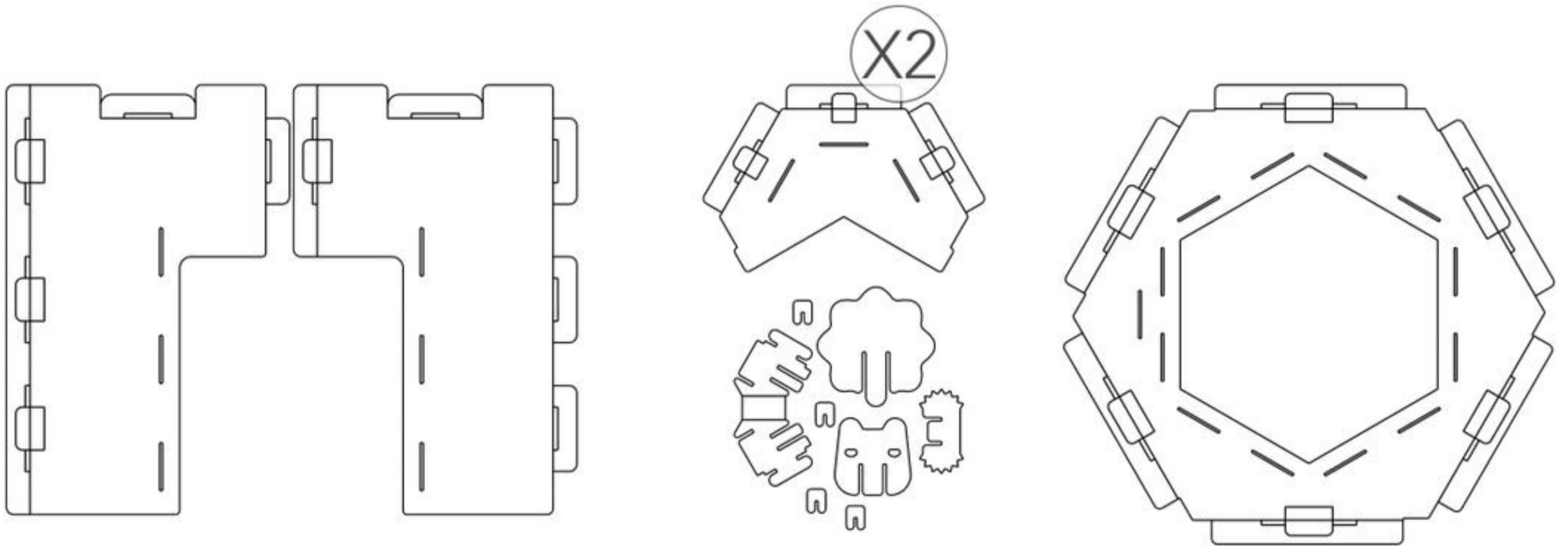
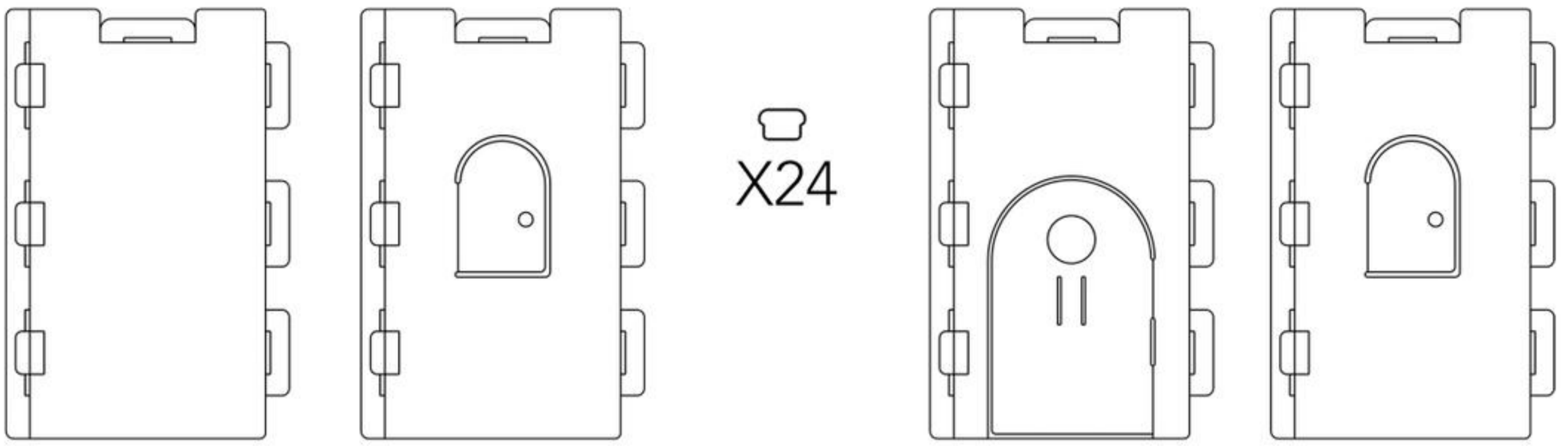

  
X6

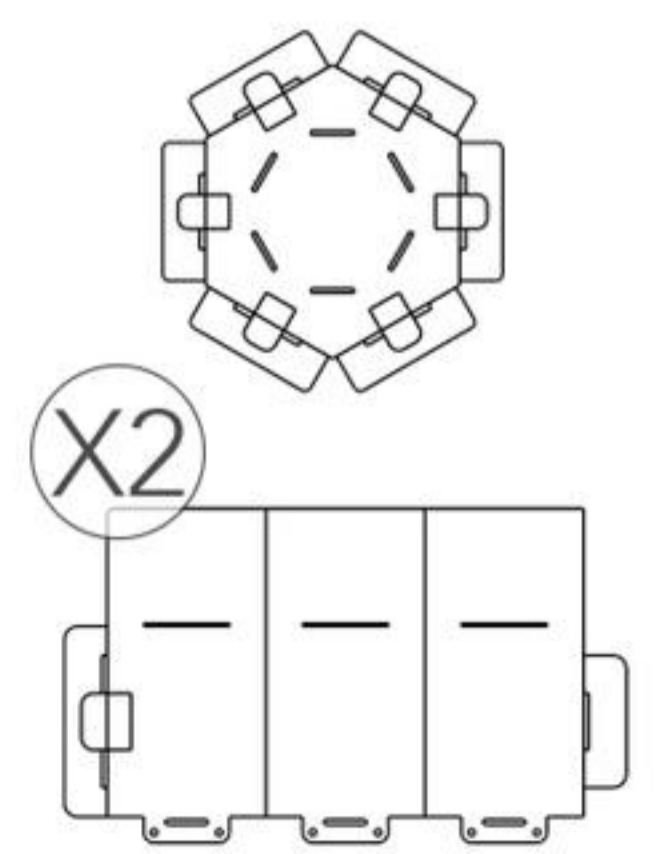
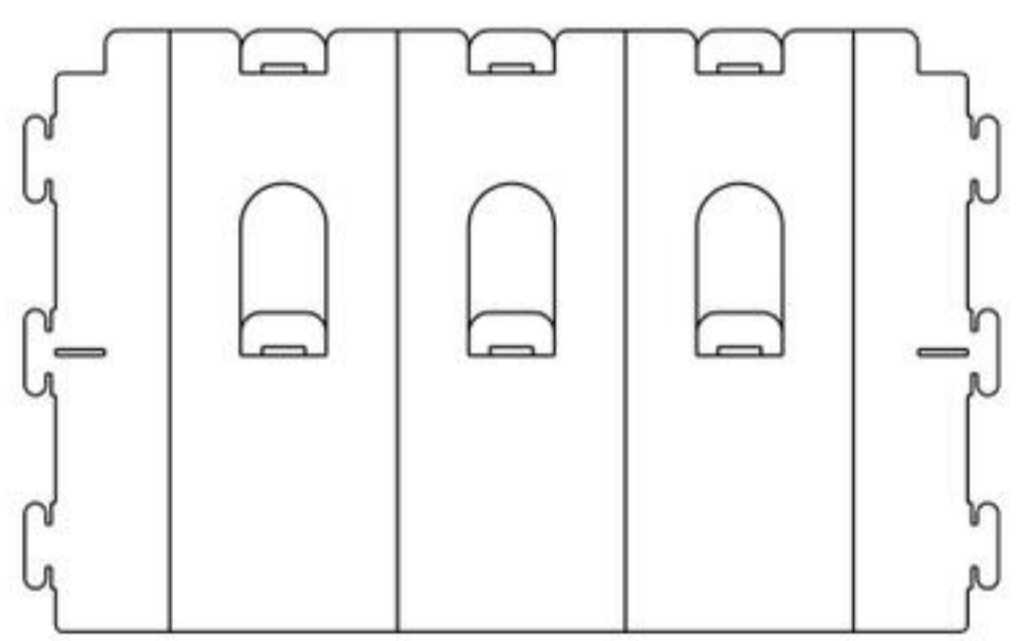

**PARTS  
SUPPLIED**

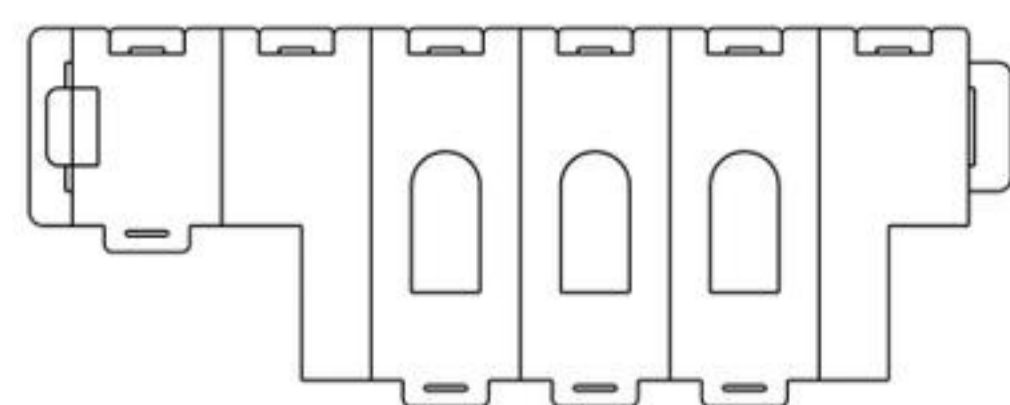

 X16

