



## **RESIDENTIAL INSTALLATION MANUAL SWIM JOY SOLAR POOL HEATER**

**\*\*\* READ ALL INSTRUCTIONS THOROUGHLY FROM START TO FINISH BEFORE BEGINNING INSTALLATION. IF THESE INSTRUCTIONS ARE NOT PROPERLY FOLLOWED, DAMAGE MAY OCCUR TO THE PRODUCT AND POOL EQUIPMENT. SOLARPOOLSUPPLY ISN'T RESPONSIBLE FOR ANY DAMAGE OR FAILURE RESULTING FROM IMPROPER INSTALLATION. \*\*\***

**\*\*\* SOLAR PANELS ARE OFTEN INSTALLED ON THE ROOFS OF BUILDINGS. UNLESS YOU ARE VERY FAMILIAR WITH WORKING ON ROOFS AND HAVE THE PROPER SAFETY EQUIPMENT FOR SUCH WORK, YOU SHOULD HIRE A PROFESSIONAL TO DO THE INSTALLATION. FAILURE TO USE PROPER SAFETY EQUIPMENT AND PRACTICES MAY RESULT IN SERIOUS INJURY OR DEATH. \*\*\***

**\*\*\* BEFORE BEGINNING INSTALLATION, INVENTORY ALL SYSTEM COMPONENTS AGAINST THE PARTS LIST. DON'T BEGIN INSTALLATION IF COMPONENTS ARE MISSING. SOLARPOOLSUPPLY ISN'T RESPONSIBLE FOR ANY COSTS ASSOCIATED WITH INSTALLATION DELAYS DUE TO MISSING COMPONENTS. \*\*\***

**\*\*\* BEFORE REMOVING THE SOLAR COLLECTORS FROM THE BOX, VERIFY COLLECTOR SIZE AND SUFFICIENT MOUNTING SPACE TO ACCOMMODATE THE SYSTEM. DUE TO THE MATERIAL TYPE, THESE COLLECTORS ARE SUSCEPTIBLE TO DAMAGE IF MISHANDLED. DAMAGED COLLECTORS CAN'T BE RETURNED. \*\*\***

**CUSTOMER SERVICE & TECHNICAL SUPPORT**

**PHONE (844) 931-3080**

**CONTACT@SOLARPOOLSUPPLY.COM**



# 1. Introduction/Table of Contents

Swim Joy panels are manufactured utilizing cutting edge technology and the most advanced production techniques. A Swim Joy solar system will provide years of worry-free performance as it captures safe, reliable heat from the sun year after year.

This manual will give you a great deal of valuable information. Take time and read through this manual. It will guide you through the most efficient way to correctly install an Swim Joy solar system. By following this step-by-step guide, your system will meet the installation standards recommended by the factory.

While the manual explains how to install Swim Joy solar panels properly in typical situations, it cannot address all the unique or individual circumstances possible. If you have any installation questions, contact your Swim Joy Representative for assistance. As the installer, you are responsible for exercising good judgment when installing Swim Joy systems to protect the long term integrity of the panels as well as the mounting surfaces.

- 1. Introduction.....Page 1
- 2. Spec Sheet.....Page 2
- 3. Getting Started.....Page 3
- 4. Things To Remeber.....Page 4-5
- 5. Installation Kits & Components.....Page 6-9
- 6. Installation Materials & Tooling.....Page 9
- 7. Solar Panel Layouts & Hydraulics.....Page 10-14
- 8. Connecting the Solar Panels Together.....Page 15-16
- 9. Mounting the Solar Panels.....Page 17-21
- 10. Mounting the Solar Panels On A Flat Roof or Ground Rack.....Page 22
- 11. Assembly of Row Spacer Kits.....Page 23
- 12. Connecting the Solar Panels to the Feed & Return Lines.....Page 24
- 13. Running the Feed & Return Lines From Roof to Ground Level.....Page 25
- 14. Connecting the Feed & Return Lines to the Filtration System.....Page 26-28
- 15. Pressure Testing the System.....Page 29
- 16. Operation & Check-Out Procedures.....Page 30
- 17. Troubleshooting.....Page 31-32
- 18. Repair Procedures.....Page 33
- 19. Warranty Policy.....Page 34

# 2. Spec Sheet

## SJ-50

Thousands of BTU's per day per panel

### SOLAR INSOLATION

Category T(°F)		2,000 BTU/ft <sup>2</sup>	1,500 BTU/ft <sup>2</sup>	1,000 BTU/ft <sup>2</sup>
Water temp. minus air temp.	A (-9)	101.28	77.17	57.88
	B (+9)	48.23	28.94	9.65
	C (+36)	4.82	0	0
	D (+90)	0	0	0

## SJ-38

Thousands of BTU's per day per panel

### SOLAR INSOLATION

Category T(°F)		2,000 BTU/ft <sup>2</sup>	1,500 BTU/ft <sup>2</sup>	1,000 BTU/ft <sup>2</sup>
Water temp. minus air temp.	A (-9)	77.03	58.69	44.02
	B (+9)	36.68	22.01	7.34
	C (+36)	3.67	0	0
	D (+90)	0	0	0

## SJ-40

Thousands of BTU's per day per panel

### SOLAR INSOLATION

Category T(°F)		2,000 BTU/ft <sup>2</sup>	1,500 BTU/ft <sup>2</sup>	1,000 BTU/ft <sup>2</sup>
Water temp. minus air temp.	A (-9)	85.43	65.09	48.82
	B (+9)	40.68	24.41	8.14
	C (+36)	4.07	0	0
	D (+90)	0	0	0

## SJ-30

Thousands of BTU's per day per panel

### SOLAR INSOLATION

Category T(°F)		2,000 BTU/ft <sup>2</sup>	1,500 BTU/ft <sup>2</sup>	1,000 BTU/ft <sup>2</sup>
Water temp. minus air temp.	A (-9)	61.22	46.64	34.98
	B (+9)	29.15	17.49	5.83
	C (+36)	2.92	0	0
	D (+90)	0	0	0

## KEY:

**A** - Pool Heating (Warm Climate)    **B** - Pool Heating (Cool Climate)    **C** - Water Heating (Warm Climate)  
**D** - Space & Water Heating

## CERTIFICATION DATA

BTUs PER DAY

Certifying Organization	SJ-50	SJ-40	SJ-38	SJ-30	Performance Expectations
National Standard SRCC Equivalent of 948 BTU/sq ft	48,230	40,680	36,680	29,150	$\eta = (0.909)(1 - 0.0206u) - (2.1084 + 1.1254u)(P/G)$
Florida Standard	956 BTU's/ft <sup>2</sup>				$0.828 - 3.26 (T_i - T_a) / I$ $K_p X = 1.00 - 0.11(S)$

## COLLECTOR DATA

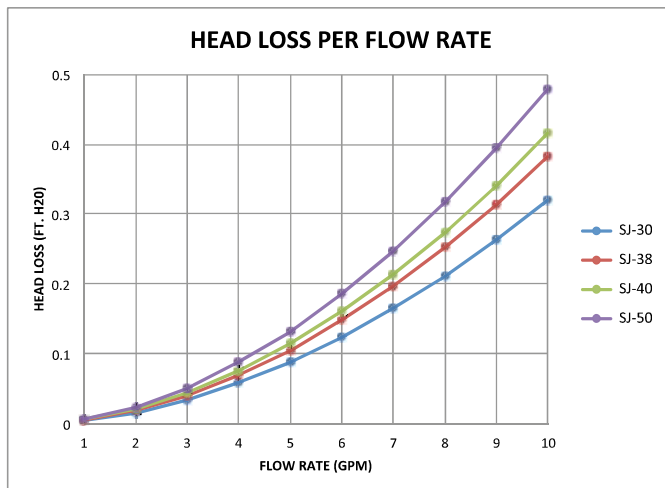

Collector Model	SJ-50	SJ-40	SJ-38	SJ-30
Size, Nominal	4' x 12.5'	4' x 10.5'	4' x 9.5'	4' x 7.5'
Width	48.41"	48.41"	48.41"	48.41"
Length	152.88"	128.44"	116.28"	91.94"
Aperture Area (SF)	48.23	40.68	36.68	29.15
Manifold Diameter	2"	2"	2"	2"
Weight (dry)	24lbs	22lbs	19lbs	16lbs
Volume Capacity	3.7 gal	3.1 gal	2.8 gal	2.4 gal
Working Pressure	90 psi	90 psi	90 psi	90 psi
Burst Pressure	270 psi	270 psi	270 psi	270 psi
Typical Flow	5-7 gpm	4-6 gpm	3.8-5.5 gpm	3-4.4 gpm

Distributed By:



Customer Service & Technical Support  
 Phone (844)931-3080  
 contact@solarpoolsupply.com





## 3. Getting Started

### BEFORE YOU START YOUR INSTALLATION, HERE ARE A FEW IMPORTANT TIPS:

**1. Caution - SAFETY COMES FIRST!**

*There is no substitute for safety. Always exercise extreme caution, care, and good judgment when working on or around a roof or pool area.*

- **Please take care to avoid hazards such as overhead electrical wires or loose shingles.**
- **Be sure to secure ladders so they will not slip or fall.**
- **Do not allow extension cords to lie in the pool or in standing water.**
- **Wear shoes with proper tread to prevent slipping on the ladder or sloped roof areas.**
- **Disconnect all power to the pool equipment when installing an automatic control system.**

**2. Check with your local building department to determine permitting and code requirements in your area.**

**3. While this manual explains how to install Swim Joy solar panels properly in typical situations, it cannot possibly address all the unique or individual circumstances possible. If you have any installation questions, contact your Swim Joy representative for assistance.**

**4. Before starting any work, determine the location of your system and prepare a schematic drawing of the installation area. Include the location of the feed and the return lines in this drawing. Roof areas often times look bigger than they really are, so be sure to measure the available area before making your schematic. Be sure that the layout of the panels will allow the panels to drain when the pool pump shuts off.**

**5. Familiarize yourself with all of the Swim Joy components and plumbing materials that you will need to complete the installation.**

**6. Don't take shortcuts. Whenever possible, panels should be installed so they are accessible without being walked on. Walking on the panels should only take place when absolutely necessary.**

**7. Depending upon your specific job, you will need various plumbing items and materials. Be sure to use quality products that will withstand direct sunlight year after year.**

**PVC PIPE** - Use PVC SCHEDULE 40 pressure rated pipe. Do not use ABS or a lower standard substitute.

**PVC FITTINGS** - Use PVC SCHEDULE 40 pressure rated fitting to match your PVC pipe.

**DO NOT USE** - "plumber's" fittings or DWV fittings (drain, waste, vent).

**PVC CLEANER AND CEMENT** - It is important to both CLEAN and CEMENT each PVC joint. When gluing CPVC fittings to PVC pipe, such as the (2-1810-005) pipe connector, it is necessary to use a good quality **multi-purpose cement**.

**NOTE: As the installer, you are responsible for exercising good judgment when installing Swim Joy systems to protect the long term integrity of the panels as well as the mounting surfaces.**

## 4. Things to Remember

**NO TWO INSTALLATIONS ARE EXACTLY ALIKE BUT THERE ARE SOME GENERAL BITS OF TECHNICAL INFORMATION THAT YOU WILL FIND HELPFUL IN THE FIELD.**

**ROOF ORIENTATION** - Ideally, panels should be located on a south facing or flat roof or on an elevated ground mounted rack facing south. The next best orientation is west and finally east. Panels should never be installed facing north in the Northern hemisphere.

**PANEL CONFIGURATIONS** - There are many ways to configure a solar array. The most common and preferred is in a continuous row. The recommended limit to the number of panels that can be installed this way to achieve even flow throughout the array is (12) 4'x7.5' panels, (10) 4'x10.5' panels, or (8) 4'x12.5' panels.

This maximum guideline can be exceeded if there is a high flow or substantial back pressure on the system which will force adequate flow through every panel. When you have more than the maximum, you should either use the double row layout or the single row split feed layout. Of course, the double row can also be used for smaller installations when space is a problem. (Fig. 10.2, page 10).

If you have to split up an array due to a skylight or change in roof level or direction, the layout will be similar to single row split feed layout.

**PUMP HORSEPOWER** - The horsepower of your swimming pool filtration pump must be adequate to supply the solar system with enough water to provide the recommended flow rate necessary for the panels being installed. The recommended rates are:

Panel #	Size	Maximum Per Row
2-9999-150	4' x 6.5'	12
2-1100-030	4' x 7.5'	12
2-1100-038	4' x 9.5'	10
2-1100-040	4' x 10.5'	10
2-1100-050	4' x 12.5'	8
2-1100-062	4' x 15.5'	8

Generally, a 1-horsepower pump is sufficient for a standard pool solar system unless there is an unusually long pipe run, a high roof or a large number of panels. If you are not sure what your pump flow rate is, consult your Swim Joy representative for the pump's flow characteristics.

**PLUMBING** - It is important that you use the proper size PVC pipe for the size of the solar array. Under sizing the pipe will produce too much restriction to the water flow and unnecessarily reduce the flow rate to the panels. Use the following as a guide:

Flow Rate	Minimum Pipe Size (ID)
0 to 30 GPM	1.5" ID
31 to 50 GPM	2" ID
51 to 70 GPM	2.5" ID

Plumbing runs should be as short as possible and the "hot return" pipe should have the shortest run to reduce the potential heat loss in the pipe. Horizontal pipes should be supported with a pipe clamp at least every 4 feet to prevent sagging. The pipe clamp used on pipe runs across a roof should be ½" larger than the pipe diameter to allow for expansion and contraction, unless you are using our glass-reinforced PP pipe clamps (see page 8) that expand and contract with the pipe. Pipe clamps should be used on vertical or horizontal runs on the side of a building and should be the same size as the pipe diameter to prevent movement.



## 4. Things to Remember, - Cont.

**AUTOMATIC DRAIN DOWN** - Both the solar panels and the PVC pipe should be installed so the water will drain out of them when the pump shuts off. A non-positive or solar 3-port valve is required for automatic drainage. This is especially important in areas of the country where harsh winter conditions cause freezing conditions; however, the freezing point for solar panels starts at 40 degrees, so freeze damage can occur in virtually any area of the United States.

The Swim Joy solar pool panels are warranted against internal freezing when installed to allow for drain down. If, as a result of a unique roof design or adverse pool equipment locations (as demonstrated in figure 4.1 below), it is not possible to achieve complete automatic drain down, manual drain down valves should be installed in appropriate places in the plumbing or at the end of the bottom (feed) header.

Instead of installing an end cap (2-1810-013) at the end of the header, you would install a manual drain down bib attachment set (1-5115-021AS).

These valves should be opened when shutting down the system for the winter months or when freezing conditions are possible. Your Swim Joy representative can assist you with the parts necessary for manual drain down installations.

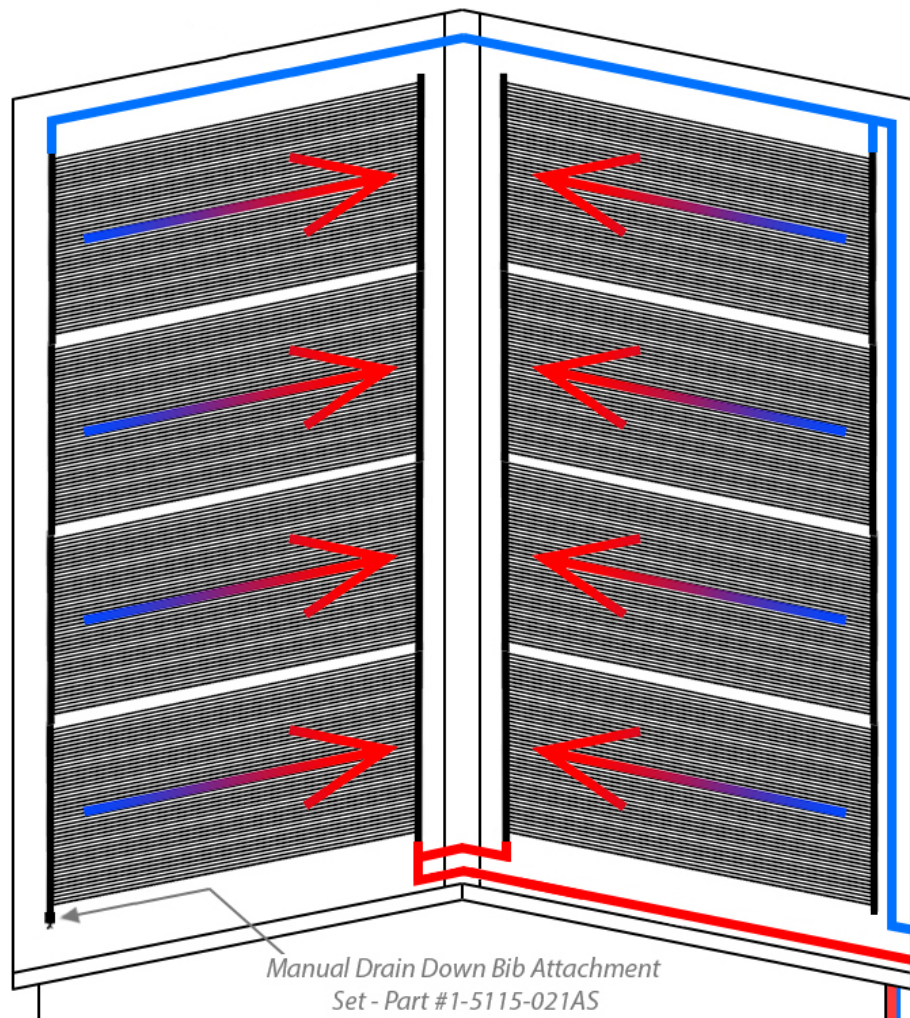

Fig 4.1

## 5. Installation Kits & Components



PANEL INSTALLATION KIT  
Part #2-1145-001



ROW INSTALLATION KIT  
Part #2-3045-001



VACUUM RELIEF VALVE ATTACHMENT SET  
Part #2-1410-023A



PRESSURE TESTING KIT  
Part #2-3020-022



ROW SPACER KIT  
Part #2-3045-003



VACUUM RELIEF VALVE HEADER  
ATTACHMENT SET Part #2-1410-023H



MANUAL DRAIN DOWN BIB ATTACHMENT  
SET Part #1-5115-021AS



SOLAR PANEL REPAIR KIT  
Part #2-3020-029

## 5. Installation Kits & Components, - Cont.



**MOUNTING PAD, TOP HEADER**  
Part #2-1160-001



**MOUNTING PAD, BOTTOM HEADER** Part #2-1160-002



**CPVC PIPE CONNECTOR**  
Part #2-1810-005



**END CAP**  
Part #2-1810-013



**PANEL CLAMP BOTTOM**  
Part #2-1810-015



**PANEL CLAMP TOP**  
Part #2-1810-020



**PANEL CLAMP GASKET**  
Part #2-1810-017



**PANEL CLAMP LATCH**  
Part #2-1810-018



**VACUUM RELIEF VALVE**  
Part #2-1810-029



**REPAIR PLUGS**  
Part #2-1120-001



**PVC PIPE SUPPORT BRACKET**  
BLACK, 2" Part #30272-2  
(White & 1.5" Also Available)



**EXTRA WIDE TOP HEADER BRACKET** Part #2-1160-003



## 5. Installation Kits & Components, - Cont.

The following section details all of the Swim Joy installation kits included with each DIY System Kit that are required to install a Swim Joy solar pool heating system in one single row as detailed in figure 10.1 on page #10. These DIY System Kits are designed as a "base" starting point. Given the endless variables to each installation it is impossible to include all of the materials and components necessary to complete each and every installation. Additional components may be required depending on your specific installation and layout requirements. Page #6 details optional installation kits offered separately that may be required depending on the layout, installation, operation and maintenance requirements of your specific installation.

### 2-1145-001: PANEL INSTALLATION KIT

One of these kits is required for each panel. Your DIY System Kit will include one panel installation kit for each solar panel. It contains the parts necessary to connect the panels together and secure them to the mounting surface. Each installation kit contains: (2) 2-1160-001 Mounting Pad Top, (2) 2-1160-002 Mounting Pad Bottom and (2) 2-1810-004 Panel Clamp Assembly.

### 2-3045-001: ROW INSTALLATION KIT

One of these kits is required for each row of panels. Your DIY System Kit will include one row installation kit. It contains the parts necessary to connect the feed and return lines to one row of panels. If your specific layout requires more than one row of panels, you will need one additional row installation kit for each additional row of panels. The row installation kit contains: (2) 2-1810-004 Panel Clamp Assembly, (2) 2-1810-013 End Cap and (2) 2-1810-005 Pipe Connector CPVC.

### 2-1410-023A: VACUUM RELIEF VALVE ATTACHMENT SET

One of these kits is required for each system. Your DIY System Kit will include one vacuum relief valve attachment set. It contains the parts necessary to allow air into your system for proper gravity drainage. The attachment set contains: (1) 2-1810-029 Vacuum Relief Valve, (1) 2-2015-082 Reducer Bushing and (1) 401-020BC Schedule 40 PVC "T" Fitting, 2", White.

### 2-3020-022: PRESSURE TESTING KIT

This kit gives you the components required to pressure test the system once installation is complete. The pressure testing kit comes as one "T" assembly featuring a ball valve and pressure gauge. Attaches to 3/4" FPT reducer bushing (located in vacuum relief valve location of the 2-1410-023A attachment set).

The following is a description of optional installation and service kits that are offered separately. These items may be necessary depending on the layout, installation, operation and maintenance requirements of your specific installation.

### 2-3045-003: ROW SPACER KIT

One of these kits is required if you need to space around a roof obstruction larger than 6" or an obstruction that is too close to the header, such as a skylight, chimney, vent tube, etc. It can also be used to connect different rows of panels into one row that are on different roof levels or on different roof pitches that are facing different directions. It contains the parts necessary to connect the rows of panels utilizing PVC pipe between them. The installation process for the row spacer kit is detailed on page #23. Each row spacer kit contains: (4) 2-1810-005 Pipe Connector and (2) 2-1810-004 Panel Clamp Assembly.

### 2-3045-001: ROW INSTALLATION KIT

One of these kits is required for each row of panels. Your DIY System Kit will include one row installation kit. It contains the parts necessary to connect the feed and return lines to one row of panels. If your specific layout requires more than one row of panels, you will need to purchase an additional row installation kit for each additional row of panels. The row installation kit contains: (2) 2-1810-004 Panel Clamp Assembly, (2) 2-1810-003 End Cap and (2) 2-1810-005 Pipe Connector CPVC.



## 5. Installation Kits & Components, Cont.

### 2-3020-029: REPAIR TOOL KIT

In the event a panel riser tube is damaged, this kit contains everything needed to make a repair to a riser tube. The repair kit contains: (1) 2-1810-007 Plug Insertion Tool, (1) 2-1910-008 Chisel Cutting Tool and (16) 2-1120-001 Repair Plugs.

### 1-5115-021AS: MANUAL DRAIN DOWN BIB ATTACHMENT SET

For installations that will not automatically drain due to installation location or plumbing limitations, this set will allow you to manually drain water from your panels directly at the header. This set contains: (1) 2-1810-005 Pipe Connector, (1) 429-020B PVC Coupling, (1) 2-2015-082 Reducer Bushing and (1) Drain Bib, Brass.

### 2-1410-023H: VACUUM RELIEF VALVE ATTACHMENT SET, HEADER MOUNT

For installations below pool grade or installations that will not automatically drain, a header mount vacuum relief valve is recommended to allow air into the panels when the feed and return lines are isolated with diverter or ball valves. This set should be combined with the manual drain down bib attachment set (#1-5115-021AS) to allow all of the water to drain from the panels. This set contains: (1) 2-1810-005 Pipe Connector, (1) 406-020B PVC Elbow, 90 Degree, Black, (1) 2-2015-082 Reducer Bushing and (1) 2-1810-029 Vacuum Relief Valve, 3/4" MPT.

## 6. Installation Materials & Tooling

Our DIY System Kits are designed as a "base" starting point. Given the endless variables to each installation it is impossible to include all the materials and components required to complete the installation. Each installation is unique and will require additional components and materials to complete the installation based on panel layout, piping, roof material, etc. Below is a list of components, materials and tooling that may be required depending on your specific installation.

### MATERIALS

- Schedule 40 PVC Pipe
- 3-Port Valve
- Check Valve
- Silicone O-Ring Lubricant
- Zip Ties
- 12ga-14ga Electrical Wire With Ground
- Schedule 40 PVC Fittings
- 2-Port Valve
- Lag Screws
- Pipe Supports
- Electrical Wire Nuts
- Electrical Conduit
- PVC Cement (Primer & Medium)
- Ball Valve
- High Quality Sealant
- Flow Meter
- 18ga-22ga Sensor Wire
- Teflon Tape

### TOOLING

- Power Drill With Corresponding Bits & Sockets
- Channel Lock Pliers
- Pipe Cutter, Hacksaw Or Reciprocating Saw To Cut PVC Pipe
- Basic Hand Tools
- Caulking Gun
- Ladder

**NOTE:** While this manual explains how to install Swim Joy solar panels properly in typical situations, it cannot address all the unique or individual circumstances possible. It is the installers responsibility to exercise good judgment and follow proper installation procedures to protect the long-term integrity of the panels as well as the mounting surfaces.

# 7. Solar Panel Layouts & Hydraulics

The following 4 layout and plumbing diagrams are the most common solar panel installations.

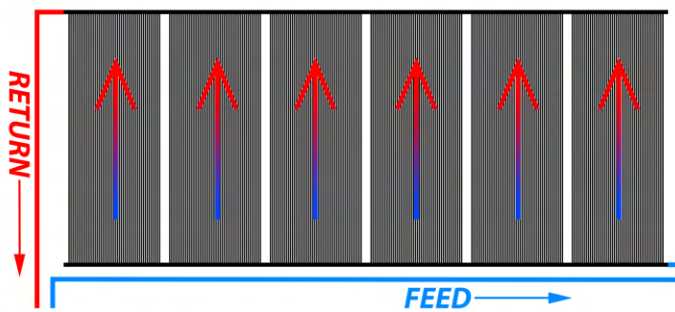

Fig. 10.1 - SINGLE ROW

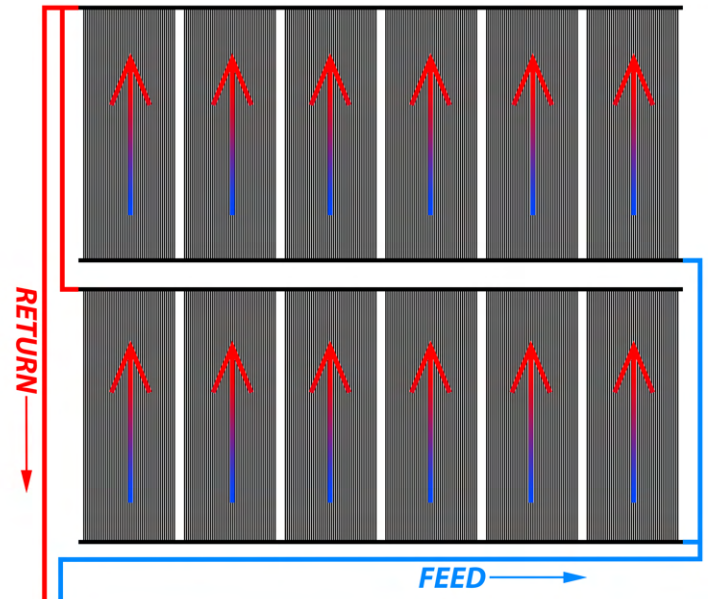

Fig. 10.2 - DOUBLE ROW

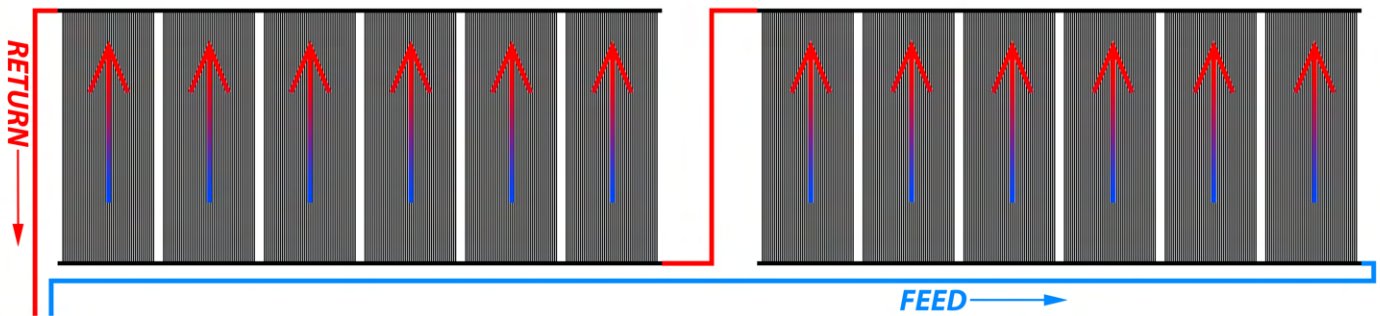

Fig. 10.3 - SINGLE ROW SERIES FEED

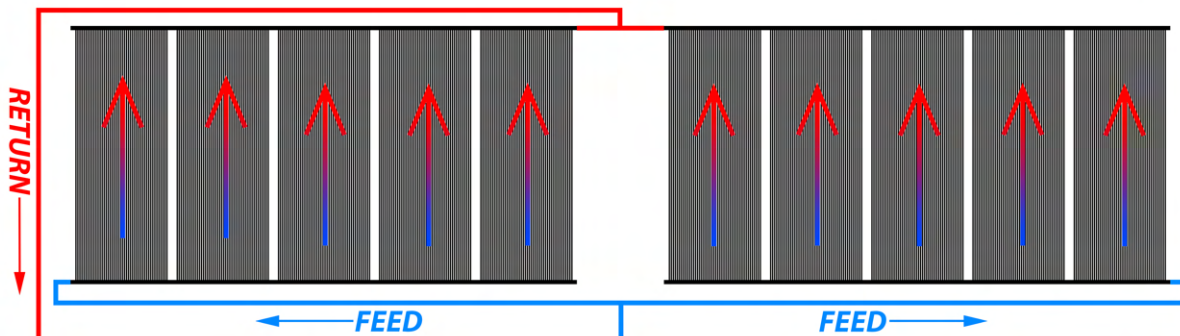

Fig. 10.4 - SINGLE ROW SPLIT FEED

## 7. Solar Panel Layouts & Hydraulics. - Cont.

Figure 11.1 below details the installation locations of the mounting hardware included in each DIY System Kit. This is an example of a common installation. Mounting locations may differ due to system location, roof truss location, roof material type, etc. For commercial installations please contact a Swim Joy representative for system design assistance.

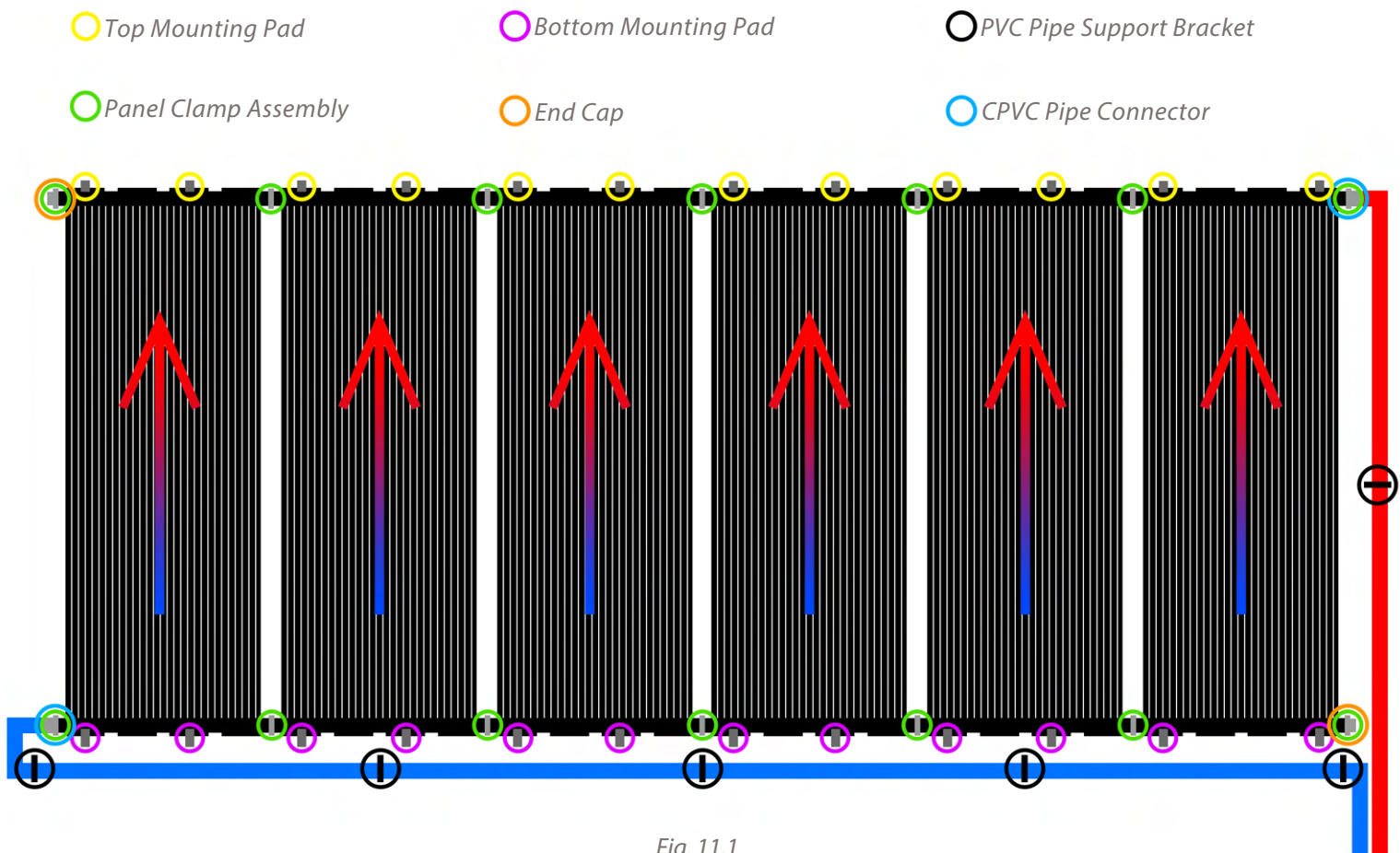

Fig. 11.1

**NOTE:** The spacer bars that hold the individual riser tubes together should be facing down onto the mounting surface lifting the panel up off of the mounting surface.

**NOTE:** On soft roof surfaces or lesser quality asphalt shingle materials an EPDM or aluminum pad underneath the panel clamp assembly may be necessary to eliminate possible roof wear.



## 7. Solar Panel Layouts & Hydraulics. - Cont.

**ROOF ORIENTATION** - Ideally, panels should be located on a south-facing or flat roof on an elevated ground mounted rack facing south. The next best orientation is west and finally east. A panel should never be installed on a north roof without a reverse rack in the Northern hemisphere.

**CHOOSING THE RIGHT SIZE PANEL** - The roof space available to you will determine which model panel to use. Since Swim Joy manufactures panels in ten different sizes, you have great flexibility in what you can design. The ten panels sizes are:

Panel #	Size	Header Width	Length Mounted
2-1100-008	1' x 7.5'	13.5"	8' +/- 1"
2-1100-009	1' x 9.5'	13.5"	10' +/- 1"
2-1100-010	1' x 10.5'	13.5"	11' +/- 1"
2-1100-012	1' x 12.5'	13.5"	13' +/- 1"
2-9999-150	4' x 6.5'	48.625"	7' +/- 1"
2-1100-030	4' x 7.5'	48.625"	8' +/- 1"
2-1100-038	4' x 9.5'	48.625"	10' +/- 1"
2-1100-040	4' x 10.5'	48.625"	11' +/- 1"
2-1100-050	4' x 12.5'	48.625"	13' +/- 1"
2-1100-062	4' x 15.5'	48.625"	16' +/- 1"

Whenever possible, the 2-1100-050 (4'x12.5') panel should be used. This will reduce the total cost of the system, reduce installation time and materials, reduce the width of solar array, reduce the number of roof penetrations and produce a more attractive installation.

However, unique roof designs may require a combination of different size panels to best cover the roof area.

**PANEL CONFIGURATIONS** - There are many ways to configure a solar array. The most common and preferred is in one continuous row as shown in Fig. 10.1 on page #10. However, there are recommended limits to the number of panels that can be installed this way to achieve balanced flow throughout the array. The maximum number of panels per row are:

Panel #	Size	Maximum Per Row
2-9999-150	4' x 6.5'	12
2-1100-030	4' x 7.5'	12
2-1100-038	4' x 9.5'	10
2-1100-040	4' x 10.5'	10
2-1100-050	4' x 12.5'	8
2-1100-062	4' x 15.5'	8

These maximums can be exceeded if there is high flow or substantial back pressure on the system, which will force adequate flow through every panel. When you have more than the maximums, you should either use the double row layout detailed in Fig. 10.2 or the single row split feed layout detailed in Fig. 10.3 on page# 10. Of course, the double row can also be used for smaller installations when space is a problem.



## 7. Solar Panel Layouts & Hydraulics. - Cont.

**PUMP HORSEPOWER** - The horsepower of your swimming pool filtration pump must be adequate to supply the solar system with enough water to provide the recommended flow rate necessary for the panels being installed. These recommended rates in gallons per minute (GPM) are (0.1gal/ft<sup>2</sup>).

Collector #	Size	Recommended Flow
2-1100-008	1' x 7.5'	1 GPM
2-1100-009	1' x 9.5'	1 GPM
2-1100-010	1' x 10.5'	1 GPM
2-1100-012	1' x 12.5'	1 GPM

Collector #	Size	Recommended Flow
2-9999-150	4' x 6.5'	3 GPM
2-1100-030	4' x 7.5'	3 GPM
2-1100-038	4' x 9.5'	4 GPM
2-1100-040	4' x 10.5'	4 GPM
2-1100-050	4' x 12.5'	5 GPM
2-1100-062	4' x 15.5'	6 GPM

For example: If you are installing (10) 2-1100-040 (4'x10.5'), which is 420 sq ft of panels, utilizing the single row or double row layout (excluding series feed), your pump must be able to deliver 42 GPM to the solar array. The existing pool recirculation pump is typically adequate for recirculating the water through the solar system. Generally, a 1-horsepower pump is sufficient for a standard pool solar system unless there is an unusually long pipe run, a two-story roof, or a large number of panels. *If you are not sure what your pump flow rate is, consult your Swim Joy representative or pump manufacturer for the pump's flow characteristics.*

**PLUMBING** - It is important that you use the proper size PVC pipe for the size of the solar array. Under sizing the pipe will produce too much restriction to the water flow and unnecessarily reduce the flow rate to the panels. Use the following as a guide:

Flow Rate	Minimum Pipe Size (ID)
0 to 30 GPM	1.5" ID
31 to 50 GPM	2" ID
51 to 70 GPM	2.5" ID

For larger flow rates, consult your Swim Joy representative for the proper pipe size or alternative series plumbing techniques, which will reduce the necessary flow rates on larger systems.

Plumbing runs should be as short as possible and the "hot return" pipe should have the shortest run to reduce potential heat loss in this pipe. Pipes should be supported with pipe clamps or "G" clamps at least every 4 feet to prevent sagging. (Check with plumbing code in local jurisdiction. The pipe clamp used on pipe returns across a roof should be ½" larger than the pipe diameter to allow for expansion and contraction. The pipe clamp used on vertical or horizontal runs on the same side of the building should be the same size as the pipe diameter to prevent vibration and to assure a professional looking installation. We highly recommend our Glass-Reinforced PP Pipe Support Brackets as they fit snugly around the PVC pipe, expand and contract with the pipe and also utilize a flashing base to better seal the roof penetration. We offer these pipe clamps in 2" Black (#30272-2), 2" White (#30284-2), 1.5" Black (#30272-1) and 1.5" White (#30284-1).

Since 90-degree elbow fittings produce a high restriction to flow, you will want to use as few as possible; keep this in mind when planning your plumbing runs. Their use cannot be avoided, but with careful forethought, you will use the least number possible. The use of (2) 45-degree fittings will eliminate a 90 and reduce flow restriction.



## 7. Solar Panel Layouts & Hydraulics. - Cont.

**BALANCED FLOW** - When you have to split a solar system as in Fig. 10.2 or Fig. 10.3, page #10, it is critical that the shown plumbing runs be followed to assure equal water flow through both rows of panels. Since water will follow the path of least resistance, if one plumbing run is shorter than the other, more water will flow through it than through the other one. Keep this in mind if you design a panel layout different than the examples. *Your Swim Joy representative can also assist with this and explain the use of “balancing valves” on larger systems.*

If you are installing the solar panels on a flat roof or flat ground rack, the top (return) header of the panel should be at least 3” higher than the bottom (feed) header to assure equal flow through all of the tubes of all the panels. To achieve even distribution of water throughout the row of panels, proper flow rates and a little back pressure should be present.

**AUTOMATIC DRAIN DOWN** - The panels and the PVC pipe should be installed so the water will drain out of them when the pool pump shuts off. This is especially important in areas of the country where freezing conditions occur. (The Swim Joy solar pool panels are warranted against internal freezing when installed to allow for drain down.) To allow for the water to drain, a vacuum breaker (2-1810-029) is installed on the solar feed line above the non-positive three-way valve as shown in (Fig. 26.1, page #26). (Non-positive means that the valve allows for water to drain back through the valve even while in the off position. If you have a 3-way valve that is not non-positive, you can make it so by drilling an 1/8” hole in the diverter). If, as a result, of a unique roof design or adverse pool equipment location, it is not possible to achieve complete automatic drain down, manual drain down valves should be installed in appropriate places in the plumbing or at the end of the bottom (feed) header.

Instead of installing and end cap (2-1810-013) at the end of the header, you would install a Manual Drain Down Bib Attachment Set (#1-5115-021AS). Fig. 14.1 to the right is an example of an installation that will not automatically drain and details the additional components required to manually drain the solar panels. These valves should be opened when shutting down the system for the winter months or when freezing conditions are possible. *Your Swim Joy representative can assist you with the parts necessary for the manual drain down installations.*

**NOTE:** Solar panels can be freeze damaged if temperatures reach 40 degrees Fahrenheit, so freeze damage can occur in virtually any weather climate. It is extremely important to take the necessary steps to ensure your system will automatically gravity drain, is automated with a control system that features freeze protection or is installed with the proper components to manually drain the system.

Fig.14.1

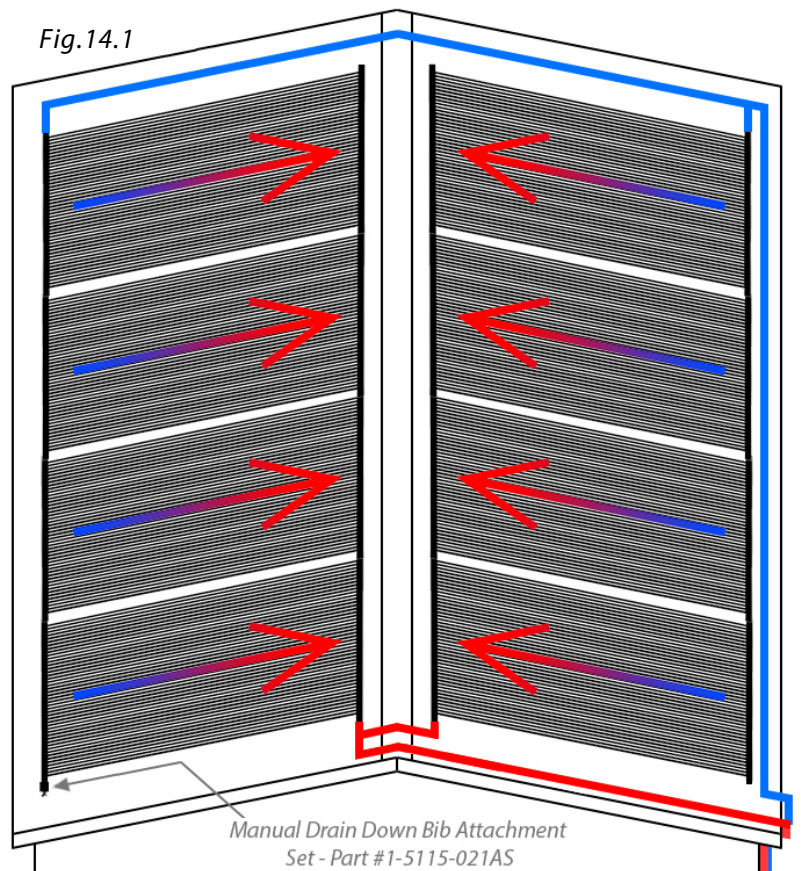

## 8. Connecting the Solar Panels Together

Later on in this installation manual you will be instructed to connect the panels together using the panel clamp assemblies. When connecting panels together, follow the directions outlined below:



Place two panels next to each other and ensure all required components, tools and silicon spray lubricant are ready to complete assembly.



Clean the grooves of both headers. Apply proper silicone o-ring lubricant to the gasket and insert one gasket into either header.

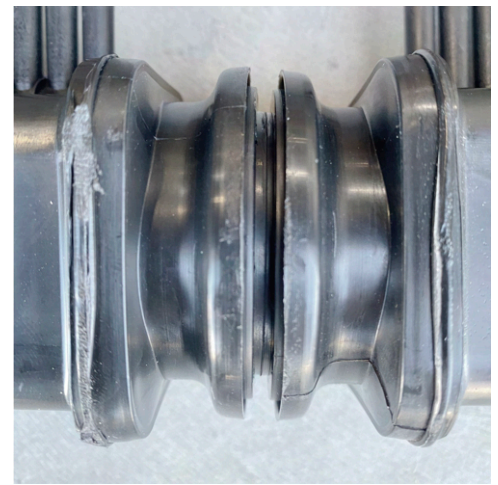

Join both headers together ensuring the gasket is properly located in both header grooves and fully seated. Only one gasket is used for each connection.

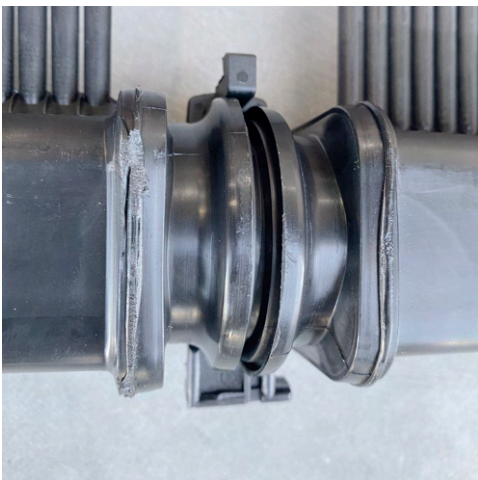

Place the bottom clamp underneath where both of the headers meet. You can apply some pressure to the top of the headers to start compressing the gasket.



Place the top clamp interlocking it with the bottom clamp swinging the top clamp around the header and aligning the angled latch portion of both clamps.



Compress the clamp assembly with channel lock pliers, which requires a good amount of force, and slide the latch onto the clamp.



## 8. Connecting the Solar Panels Together. - Cont.



Use channel lock pliers to fully seat the latch onto the panel clamp assembly.

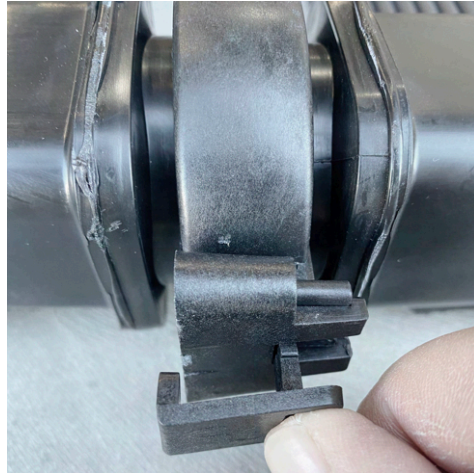

Insert the locking clip through the latch and into the panel clamp assembly locking the latch in place.



Panel clamp assembly connection is now complete. The panel clamp assemblies are used to connect panels together at both top and bottom headers, attach end caps and attach pipe connectors.

**NOTE:** The spacer bars that hold the individual riser tubes together should be facing down onto the mounting surface lifting the panel up off of the surface.

**NOTE:** On soft roof surfaces or lesser quality asphalt shingle an EPDM or aluminum pad underneath the panel clamp assembly may be necessary to eliminate possible roof wear.



Complete Panel Clamp Assembly  
Kit Part #2-1810-004

## 9. Mounting the Solar Panels

One of the top benefits of the Swim Joy installation method is its versatility. The mounting pad's flexibility allows installation of the Swim Joy panels on virtually any roof or rack surface regardless of pitch. To properly install panels utilizing the mounting pads follow these few steps:

**NOTE:** For High-Wind hardware installations read Page 19 first before beginning Step 1 below.

1. Snap a chalk line across the roof where you want the top edge of the panel header to be. This chalk line should slope upward towards where the return line will be located, to allow for proper drainage. The return line corner of the panels should be the top corner closest to the pool pump so that once the water is heated, it will be returning to the pool as quickly as possible. Be sure to allow 2" of clearance above this chalk line for the mounting pads.
2. Lay the first two panels so that the top edge of the top header is located at the chalk line. Referencing Fig. 17.1, slide a top mounting pad onto the 1st rail of the top header of the first panel (Panel "A"), and another top mounting pad onto the 3rd mounting rail of the same panel (Panel "A"). The mounting pad position of Panel "A" will continue for the rest of the row, until you get to the last panel (Panel "B"). For the last panel in the row (Panel "B"), place a top mounting pad at the 1st rail, and the second mounting pad on the 4th rail, so that each end of the row is secured at the very outside edge.
3. After positioning the mounting pads in the proper location on the first panel (Panel "A"), apply an ample amount of roof sealant to both the lag screw and to the roof for the 1st mounting pad connection. Position the 1st mounting pad on the roof and secure to the roof. The lag screws should be securely fastened, but not over-tightened. Don't secure the second mounting pad on the 3rd rail of the first panel yet. Assembling the panels in this order will make connecting the headers together with the panel clamp assemblies much easier. Next, connect the top headers of the first and second panels together using the (PPC) plastic panel clamp assembly by following the procedures described on page #15 titled "Connecting the Solar Panels Together". Once the top header of the first and second panel are connected with the panel clamp assembly, you can secure the second mounting pad located on the 3rd rail of the first panel. Repeat these steps to secure all panels to the mounting surface.
4. The last panel (reference Panel "B" in Fig. 17.1) should be secured with a top mounting pad on the 1st rail and the second mounting pad on the 4th rail. This secures the row at both outside edges.

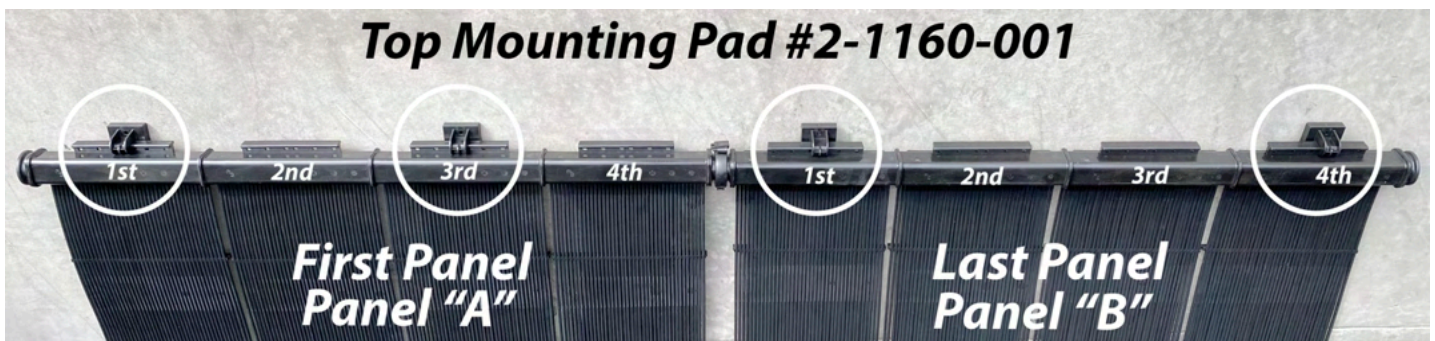

Fig. 17.1

**NOTE:** This is the recommended mounting pad location for common installations. However, it is acceptable to position the mounting pads on different rails to align with roof trusses, barrel tile roof ridges, etc.

## 9. Mounting the Solar Panels. - Cont.

The bottom mounting pads feature a unique design that both secures the bottom header to the mounting surface while still allowing the panel to thermally expand and contract.

Notice the graphic marks (Fig. 18.1) on the slider portion of the bracket. These marks are here to assist you in determining how to position the mount during installation. Each symbol refers to a possible weather condition: "snowflake" for cold and "heat waves" for hot. When it's hot outside, the panel is longer and when it's cold, the panel is shorter.

While installing the bottom mounting pads, you should consider the current ambient temperature and position the slider over the track (and grid) so that it is closer to the icon that best defines the weather. This will allow enough room for the system to expand and contract as needed. If you are unsure, install the mount at the 4th line as referenced in Fig. 18.2. This location gives the panel equal room to both expand and contract.

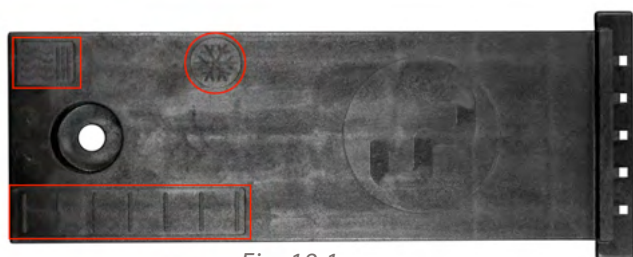

Fig. 18.1

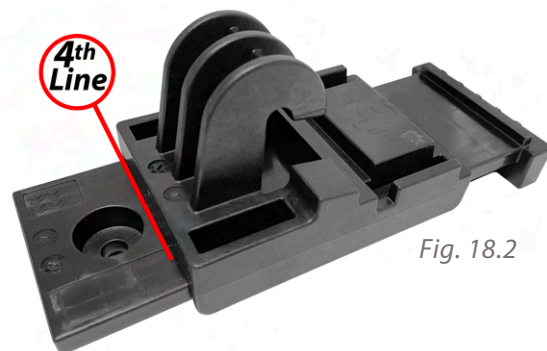

Fig. 18.2

- Once all of the top headers are connected with the panel clamp assemblies and all of the top mounting pads are secured to the mounting surface, you can repeat the same mounting pad and panel clamp assembly installation steps for the bottom headers and mounting pads.



Fig. 18.3

**Bottom Mounting Pad #2-1160-002**

**NOTE:** For tile roofs, anchor screw sets can be used for clay tile and concrete lag screws can be used for concrete tiles to attach the mounting pads to the tile. Using these style screws for tile roofs avoids the need to penetrate the roof membrane or substrate in cases where the roof tiles are properly anchored to the roof. On all types of roofs be sure to seal each penetration with the proper sealant.

**NOTE:** On soft roof surfaces or lesser quality asphalt shingle an EPDM or aluminum pad underneath the panel clamp assembly may be necessary to eliminate possible roof wear.

## 9. Mounting the Solar Panels. - Cont.

For installation locations that experience excessive windy conditions, upgrading to High-Wind Panel Installation Kits (#2-1145-002) is a mounting method that will provide additional security by utilizing an extra wide top mounting pad (#2-1160-003) and doubling the number of mounting pads per panel.

To perform the High-Wind installation method follow the same procedures detailed in Step 1 starting on Page 17 through Step 5 on Page 18. The only difference is that you will be installing the extra wide top mounting pads (#2-1160-003) instead of the standard top mounting pads (#2-1160-001) on the top header, and doubling the number of mounting pads on both top and bottom headers. Reference Figures 18.4 and 18.5 below. The same lower mounting pad (#2-1160-002) is used for both installation methods. The extra wide top mounting pads (#2-1160-003) can be secured with 1-3 lag screws depending on the mounting surface type and level of security you wish to achieve.

Fig. 18.4



Fig. 18.5

## 9. Mounting the Solar Panels. - Cont.

Once all of the top and bottom mounting pads are installed and secured to the roof, set screws need to be installed in the mounting pads in the middle of the row. The set screws are crucial to prevent the solar panels from slipping out of the mounting pads as thermal expansion and contraction occurs. Locating the set screws in the middle of the row will keep the entire row in place, but still allow expansion and contraction on the ends.

The number of panels (odd or even) in the row will determine which mounts to install the set screws in. If the total number of panels in the row is an even number, the set screws will be installed on both sides of the center header connections. If the total number of panels in the row is an odd number, the set screws will be installed only on the middle panel mounts. Reference Figure 18.4 and 18.5 below.

Figure 18.4  
Even Number Of  
Panels

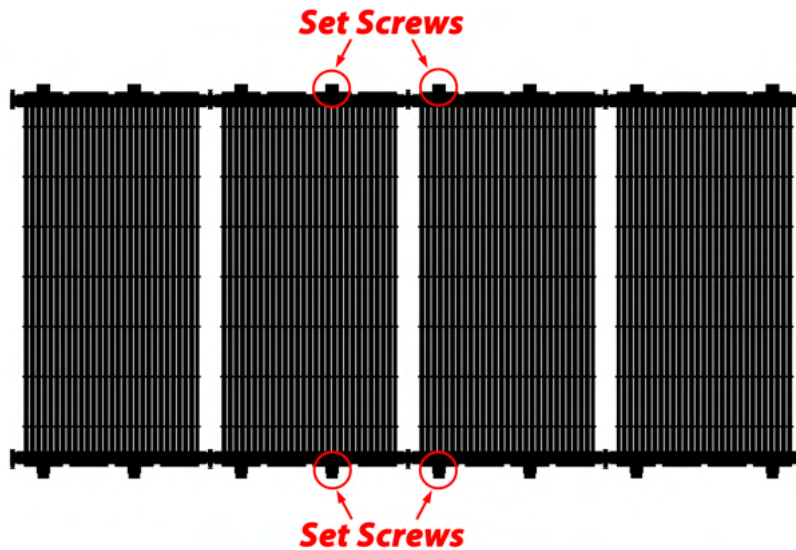
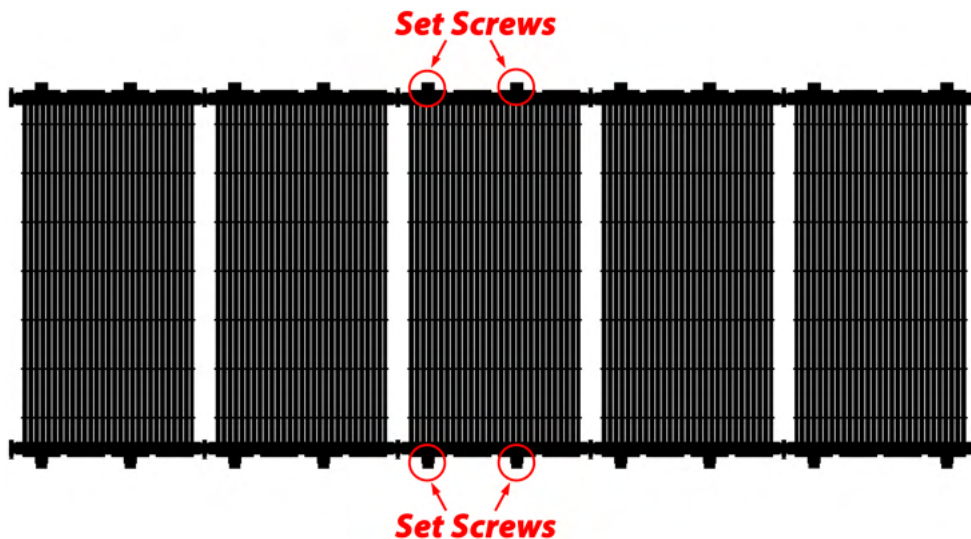

Figure 18.5  
Odd Number Of  
Panels



Only install set screws in the center two top and two bottom mounts. Don't install set screws in any other mounts.

## 9. Mounting the Solar Panels. - Cont.

- Utilizing a 1.5" long self tapping sheet metal type screw, drive the screw through the mounting pad and the "T" rail mount on the header. Reference Figures 18.6, 18.7, 18.8 and 18.9 below.

 Be sure to properly position and angle the screw when driving through the mounts to ensure it doesn't penetrate into the header and cause a leak or go completely through and into the roof or slider portion of the bottom mount.



Figure 18.6  
Top Mount



Figure 18.7  
Top Mount



Figure 18.8  
Bottom Mount



Figure 18.9  
Bottom Mount



## 10. Mounting the Solar Panels On A Flat Roof or Ground Rack

**FLAT ROOF:** If you have chosen a flat roof to mount the solar panels, it is recommended not to penetrate the surface with a lag bolt. As the installer, you are responsible for making sure that the installation will not damage the roof surface. Due to the variety of flat roof materials, please contact a Sim Joy representative for mounting advice to your specific roof type and installation location.

**GROUND RACK:** When solar panels are installed on a rack, a substrate should be mounted on the rack prior to mounting the panels. This reduces heat loss from wind, improves solar heating performance and reduces wind lift stress on the panels and mounting hardware. Fig. 19.1 below is an example of a rack constructed of galvanized steel framing stud material. Fig 19.2 shows the substrate, which is galvanized steel roofing panels flipped upside down to create a flat mounting surface. All of these materials are common and available from almost any hardware store or material supplier. We have more detailed rack information and can assist with rack design and dimensions to fit your needs, so please contact a Swim Joy representative for further assistance.

Fig. 19.1



Fig. 19.2



# 11. Assembly of Row Spacer Kits

When you need to install panels over an obstruction larger than 6' wide, or if the obstruction is less than 1' from a panel header, you'll need a row spacer kit to circumvent the obstruction.

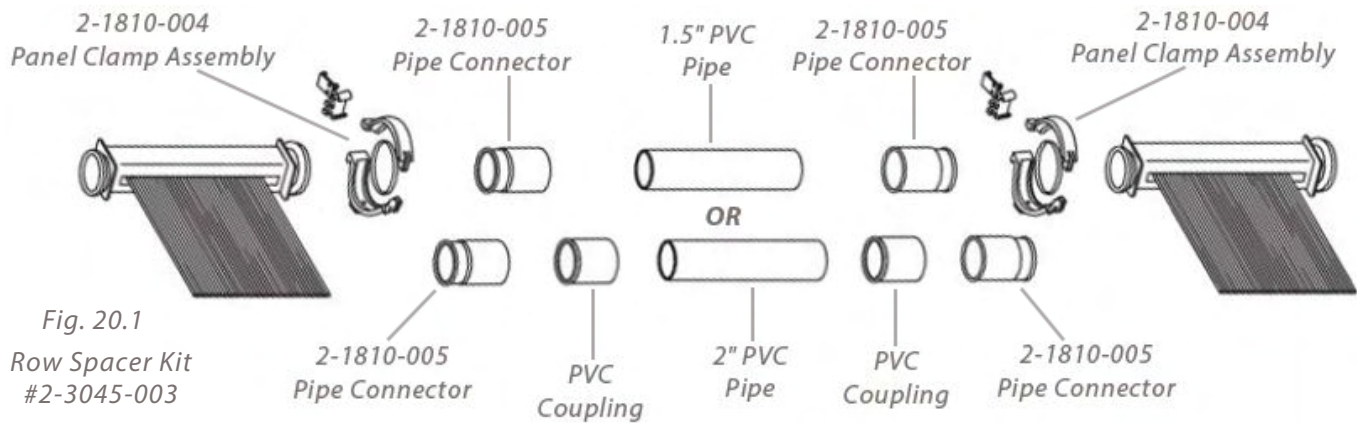

Fig. 20.1

Row Spacer Kit #2-3045-003

1. Connect (4) of the (2-1810-005) pipe connectors to the headers of the panels to be connected with the (2-1810-004) panel clamp assemblies using the same procedures outlined in the section on connecting solar panels together on page #15.
- 2a. If using 2" PVC pipe, cut two lengths of pipe long enough to cement them to a PVC coupling, which will then be cemented to the (2-1810-005) pipe connectors.
- 2b. If using 1.5" PVC pipe, cut two lengths long enough to cement the section directly to the (2-1810-005) pipe connectors on each header. 1.5" PVC pipe will slip directly into the (2-1810-005) pipe connector so no PVC couplings are required.
3. Cement the necessary components together based on the required method outlined in steps 2a or 2b.
4. If the distance between the panels is over 4', a pipe support bracket should be used on both pipes to prevent sagging.



Fig. 20.2

Flexible riser tubes are snapped out of the spacer bars to go around small obstructions.

**NOTE:** Obstructions smaller than 6" can be circumvented by snapping the panel riser tubes out of the spacer bar and spreading them around the obstructions. (see Fig. 20.2).

**WARNING** - THIS SHOULD NOT BE DONE BETWEEN THE HEADER AND THE FIRST SPACER BAR AS IT WILL POSSIBLY PULL THE RISER TUBE OUT OF THE HEADER. THE SWIM JOY WARRANTY DOES NOT COVER LEAKS OCCURRING FROM THIS TYPE OF INCORRECT INSTALLATION. A ROW SPACER KIT SHOULD BE USED FOR THIS SITUATION.





## 12. Connecting the Solar Panels to the Feed & Return Lines

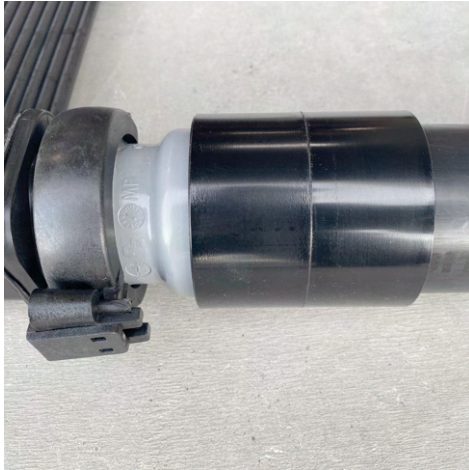

Fig. 21.1  
2" PVC Pipe Connection

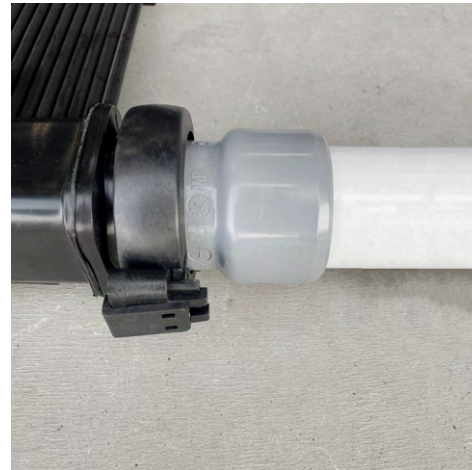

Fig. 21.2  
1.5" PVC Pipe Connection

The solar feed line will be connected to the bottom header of the panel. This should be the end farthest from the pool pump. The return line will be connected to the top header on the opposite end of the array. This should be the end closest to the pool pump.

1. Attach the (2-1810-005) pipe connector to the corners of the array where the feed and return lines will be located using the (2-1810-004) panel clamp assemblies as described in the section on connecting solar panels together on page #15.
- 2a. If using 2" PVC pipe, refer to Fig. 21.1 above. Cement a 2" PVC coupling to the (2-1810-005) pipe connector and then cement your 2" PVC pipe to the 2" PVC coupling.
- 2b. If using 1.5" PVC pipe, refer to Fig. 21.2 above. Cement the 1.5" PVC pipe directly to the (2-1810-005) pipe connector.
3. Alternatively, a fitting can be connected directly to the pipe connector. Reference Fig. 21.3 and 21.4 below.



Fig. 21.3  
2" Fitting Connection  
Socket Elbow



Fig. 21.4  
1.5" Fitting Connection  
Street Elbow



Fig. 21.5  
End Cap Connection

4. Attach the (2-1810-013) end caps on the corners opposite the feed and return lines using the (2-1810-004) panel clamp assemblies. Reference Fig. 21.5 above.

## 13. Running the Feed & Return Lines From Roof to Ground Level

Here is the standard, most straight-forward way of running the PVC pipe from the feed and return lines to the equipment pad. Some installations require a more creative approach due to unique roof designs or equipment pad locations. Whenever possible, the return line should have the shortest run and all pipes should run slightly “downhill” to allow for automatic drain-down of the plumbing and solar array. If this is not possible, manual drain valves should be installed as needed.

If your equipment pad is against your house, you may want to complete the necessary plumbing at the equipment pad before completing this portion of the installation. This allows you to know exactly where the pipe should come down from the roof. This is not necessary if you will be trenching from the equipment pad to the installation location.

1. Cement the appropriate size PVC 90-degree elbow fitting to the return line stub facing down toward the bottom header. Repeat the process for the feed line header stub and face the elbow down away from the array.

**NOTE: Whenever cementing, lay a rag on the roof or rack under the joint to avoid dripping cement on the mounting surface. Also, it is a good idea to tape or zip tie the cans of PVC cleaner and PVC cement together; they are less likely to tip over and spill this way.**

2. Determine where the feed and return pipe will go over the edge of the roof. If possible, this should be perpendicular to the exact points where they will fasten into the existing system or into pipes coming from another location (see Fig. 26.1, page #26).
3. Measure the distance from the return elbow down to the spot that you want to go, across the roof, to the point established above. **Be sure to include the depth of the socket in the elbow in your measurement.** Cut a piece of PVC pipe to this length. Repeat this process for the feed line.
4. If you are not experienced at cutting and fitting pipe, it is a good idea to assemble all pipe and fittings before cementing them just in case you make an error. Clean the burrs off of these cut pipe lengths and insert them into the elbows.
5. Measure across the roof from these pipes to the points established in Step 3. Cut and de-burr pipes to these lengths and assemble corner with 90-degree elbows.
6. Continue this process around the edge of the roof and down to the existing plumbing, keeping pipes as short, straight, and tight to the building as possible.
7. Once you are satisfied with the plumbing arrangement, go back and cement all of your joints together using the good plumbing techniques explained in the “Getting Started” section.
8. The panel mounting hardware isn't designed to support the weight of the PVC plumbing pipe in addition to the weight of the panels. PVC pipe will also sag if not properly supported. PVC pipe support brackets should be installed every 4'-6' depending on various factors. We recommend glass-reinforced PP PVC pipe support brackets available in black 2" (#30272-2), black 1.5" (#30272-1), white 2" (#30284-2) and white 1.5" (#30284-1).



# 14. Connecting the Feed & Return Lines to the Filtration System

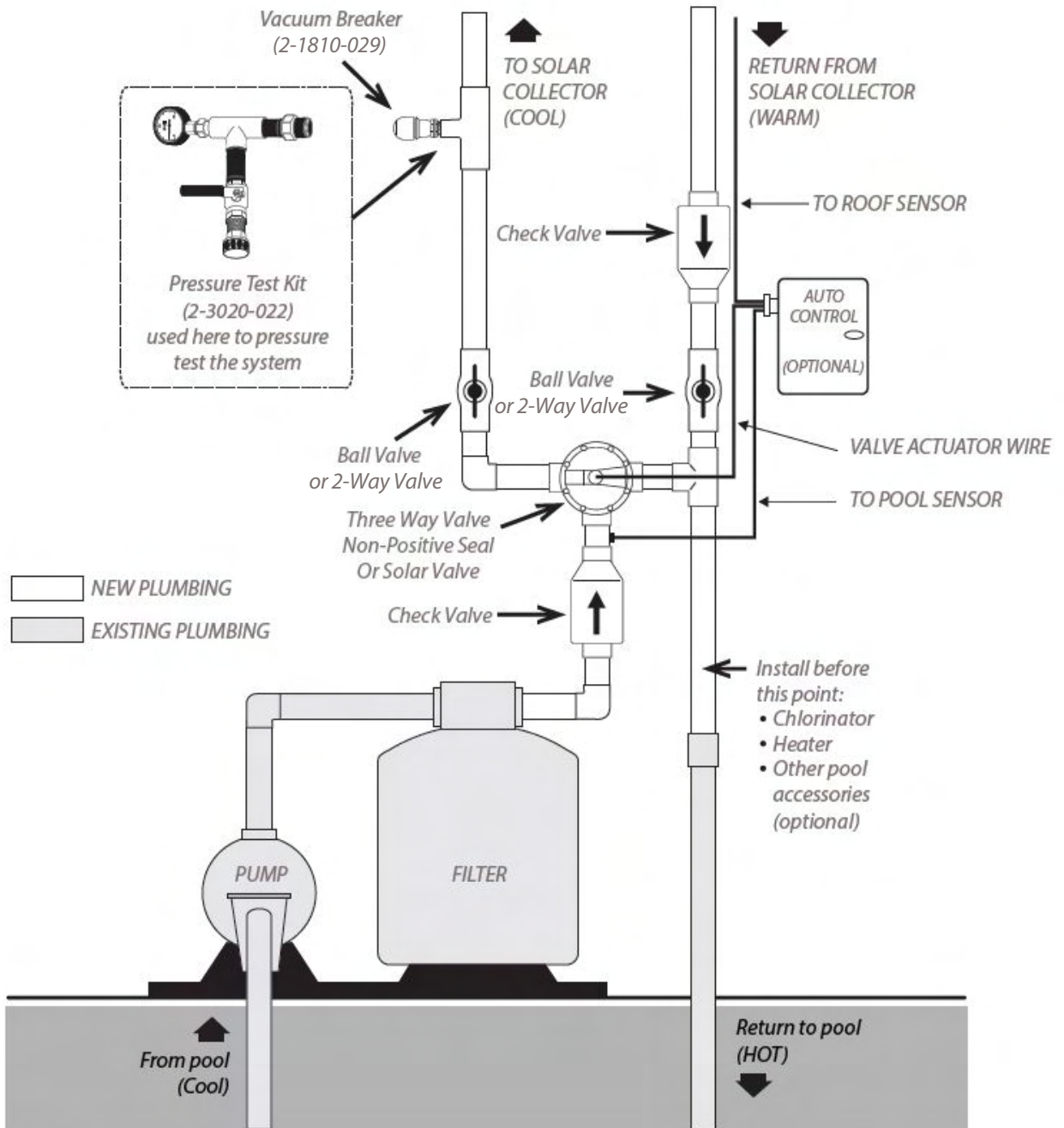

Fig. 23.1

## 14. Connecting the Feed & Return Lines to the Filtration System - Cont.

Fig. 23.1 on page #23 shows how a typical Swim Joy solar pool heating system is plumbed into existing pool plumbing. This drawing may not be just like every system you encounter; the feed and return plumbing on a solar system may be reversed, or it may be a different type of filter, or it may have additional equipment such as a chlorinator, pool cleaner, gas heater, etc. It may also have a long run of plumbing from the pool equipment to the solar panels.

Whether the system is like this or not, Fig. 23.1 will help you understand the flow of water from the pool, through the pump, filter, solar system, and back to the pool. Study the diagram and become familiar with the valves needed to connect the solar panels to existing plumbing.

Notice that the first check valve is plumbed in after the filter. This prevents the filter from being backwashed by the water draining down from the panels when the pump shuts off. The second check valve located on the solar return prevents water from back flowing through the solar panels. The 3-way valve either diverts the water to the solar system or directly back to the pool. This 3-way valve should be a non-positive seal valve or specialized solar valve. This enables the water in the solar system to drain back to the pool when the pump shuts off. The 2-way valves on the solar feed and return lines allow you to isolate (completely shut off) the solar system.

1. Study the plumbing after the filter and decide where you are going to install the check valve and the PVC tee fitting (see Fig. 23.1). If you have auxiliary equipment, you may need to re-plumb a portion of your existing plumbing so this equipment is located after the solar system as indicated in Fig. 23.1.
2. Cut the pipe after the filter where you have decided to locate the check valve and where your solar return pipe will attach to your existing pool return line. If your pool plumbing is 1-½", and you are running 2" plumbing to your solar system, you should be using 2" valves and piping for all of your new plumbing. Therefore you will need (2) 2"x1-½" reducer bushings to adapt your new 2" fittings to the existing 1-½" pipe.
3. As discussed earlier in this manual, it is a good idea to assemble all pipe and fittings before cementing them just in case you make an error. Install a check valve on the pipe coming out of the filter. Be sure that the arrow showing flow direction is pointed away from the filter.
4. The 3-way valve will be installed next. It may come right next to the check valve, or you may have to use some pipe and fittings to locate it off the main line. As stated earlier, use as few 90-degree elbows as possible.
5. Install the 2-way valve to the solar feed line and then connect the other side of the 2-way valve to one of the ports on the 3-way valve.
6. Install the (2-1810-029) vacuum breaker about 4' up the feed line and above the top of the filter using a PVC tee and reducer bushing. Face the tee to the outside as shown in Fig. 23.1. Wrap the threads of the vacuum breaker with Teflon tape and screw it into the ¾" threaded reducer bushing.
7. Install the second 2-way valve and second check valve to the solar return line.
8. Determine now where to locate the PVC tee fitting. The tee may be located right next to the 3-way valve or elsewhere depending on your system. Connect the tee fitting first to the solar return line, then to the 3-way valve, and finally to the pool return line.



## 14. Connecting the Feed & Return Lines to the Filtration System - Cont.

9. Once you are satisfied with the plumbing arrangement, go back and cement together all the joints that you have not already cemented. Use good plumbing techniques and rags to protect the existing pool equipment.

**NOTE:** Use pipe clamps the same size as the outside diameter of your plumbing fittings to secure the pipe and fittings tightly to the wall.

**NOTE:** When cementing check valves, try to do so in a horizontal position to prevent cement from dripping into the spring loaded valve and cementing it closed! When this is not possible, use cement sparingly and allow it to dry slightly before inserting the pipe into the socket. When cementing to a 3-way valve, either remove the diverter from the valve or cement with the diverter turned away from any open port to prevent the cement from running onto the diverter cementing it in place!

For a truly professional looking installation, take time to clean the PVC pipe. Use a clean rag, pour PVC cleaner on it, and then wipe the dirt and identification marks off the pipe. Do this on all exposed pipe. This is also good preparation if you plan on painting the pipe to match the house color.

**IF YOU ARE INSTALLING AN AUTOMATIC SYSTEM:** The basic difference between the manual system just outlined and an automatic system is the use of a motorized 3-way valve. This 3-way valve is operated by a differential control which uses sensors to determine if the solar system is warmer or cooler than the pool water. This way, it can shut the solar system off when cloudy conditions exist and thereby generate the optimum performance from the solar investment. It also allows you to select a maximum pool water temperature so the solar system doesn't overheat the pool. It accomplishes this by the use of a sensor on the roof and a sensor installed into the pool plumbing. It is also recommended to use an automated system with a freeze protection feature. This feature will turn on the pump and open the solar valve to cycle water through the panels preventing freeze damage. This feature will only work if the automated system and pump are compatible and able to communicate with each other. The directions included with the automatic system components will direct you in the installation of the control and sensors. The 3-way valve will be installed as described in above procedure.

## 15. Pressure Testing the System

Pressure testing the entire solar system provides for a trouble-free installation and takes only about fifteen minutes. Any weak PVC glue joint, fittings or pipe, and any improper panel clamp connections, will be evident while the system is put under 40 to 50 PSI of pressure.

1. Allow ample time for all glue joints to dry completely. Use this time to wrap up things and to clean up the job site.
2. Wrap the threads of the (2-3020-022) pressure test "T" assembly with Teflon tape. Replace temporarily the vacuum breaker with the (2-3020-022) pressure test "T" assembly. Thread the ½" ball valve and pressure gauge into the pressure test "T" assembly.
3. Attach a garden hose to the ½" ball valve. Make sure the ½" ball valve is in the "OFF" position.
4. Turn the solar system on to allow the pool pump to completely fill the solar system. (If the pool pump is not operational, shut off the ball valve on the feed line and use the garden hose to fill the system.)
5. Once the solar system is completely full of water, turn off the pool pump or turn the 3-way valve to bypass the solar system. Quickly turn off the ball valves on both the feed and return lines.
6. Turn on the city water to the garden hose and open the ½" ball valve on the pressure test "T" assembly until the pressure gauge reads 40 to 50 PSI and then turn off the ½" ball valve. Turn off city water.
7. With the system under pressure, check the whole system for any leaks. A drop in pressure on the pressure gauge indicates a leak in the system.
8. If there are leaks, open the ball valve on the return line to relieve the pressure. Repair any leaks. Repeat the pressure testing procedures as needed.
9. Return the system to normal when through with the pressure testing. Be sure to open both ball valves and replace the pressure test "T" assembly with the vacuum breaker.

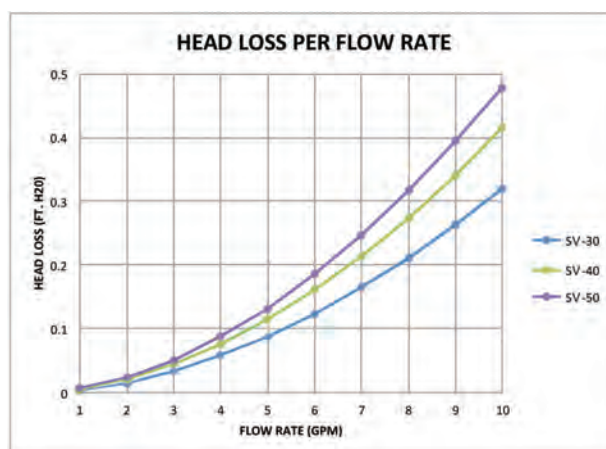



## 16. Operation & Check-out Procedures

### BEFORE YOU RUN WATER THROUGH THE SYSTEM:

1. Allow the cemented fittings adequate time to dry per manufacturer's directions.
2. Verify that the check valves, control valves, and vacuum breakers are installed properly.
3. Verify that all plastic panel clamp assemblies are tight.
4. Pressure test the system as described on page 26.
5. Verify that all anchors are secure and that adequate silicone was used to prevent any roof leaks.
6. Be sure all panel riser tubes are snapped into the spacer bars (except where they go around obstructions).
7. Be sure that the panel riser tubes are NOT rubbing on the roof surface between the spacer bars. If they are, adjust the spacer bars as needed to prevent this or a hole may develop in the riser tube.
8. Be certain that the system will automatically drain down when the pump is shut off or that enough manual drain valves have been installed.
9. Verify that all pipe runs are properly supported with pipe clamps.

### TURNING THE SYSTEM ON

1. Turn the pool pump off.
2. Turn the 3-way valve so the "closed" indicator points toward the pool return side of the valve.
3. Be sure that the 2-way valves on the feed and return lines are open.
4. Turn the pool pump on.
5. Set the pool pump timer, if used, so that the pump will run when the sun is shining on the solar panels; usually 10:00 AM to 4:00 PM, but this will vary with geographical location and time of year.
6. When the solar system is running, you should notice:
  - A slightly higher pressure reading on the pressure gauge.
  - At midday, if the sun is out, warmer water should be coming into the pool. This water should be 3° to 5°F warmer than the pool temperature. Use the back of your hand to better feel the difference in temperature.
  - While the system is running all the panels should feel cool to the touch when the sun is on them.
7. During the cooler months of the year, it is essential that the pool surface be covered at night with a "pool blanket" to maintain a comfortable water temperature. Low nighttime temperatures can lower the water temperature more than the solar can recover during the day.

### TURNING THE SYSTEM OFF

1. Turn the pool pump off.
2. Turn the 3-way valve so the "closed" indicator points toward the solar feed side of the valve.
3. If isolating the system, close the 2-way valve on the feed line after you are sure all the water has drained out of the panels and plumbing.
4. Turn the pool pump on to filter the pool as needed.

**That's all there is to it. You have installed a Swim Joy solar pool heating system that has been tested and proven world-wide for quality and reliability. If you run into any problems with your installation or have any future problems, call your Swim Joy representative.**

### CONGRATULATIONS!

**If you have carefully followed the steps in this manual, you now have an efficient, professional looking Swim Joy solar pool heating system.**

# 17. Troubleshooting

PROBLEM.	CAUSE	SOLUTION
<b>THERE ARE AIR BUBBLES IN THE POOL WHEN THE SOLAR HEATER IS OPERATING</b>	<b>1. If the pump is making more noise, there may be air coming into the pump through an air leak on the suction side of the pump due to the pump working harder to move the water through the solar system.</b>	<p><b>A.</b> Be sure pump trap lid is on tight.</p> <p><b>B.</b> Check the "O" ring on the pump trap lid. clean, lubricate, or replace as needed.</p> <p><b>C.</b> If you have a suction type pool cleaner, remove it. If this improves the air bubbles, only use it when not operating the solar.</p> <p><b>D.</b> If you have a clear lid on the pump and can see air bubbles in the trap, run water over the lid and each joint individually to see if the air bubbles will clear up using a garden hose. If there is not a clear lid, listen to pump noise for a smoother operation, repair any air leaks.</p>
	<b>2. If the vacuum breaker is installed on the roof, there is not enough water pressure in the solar system to keep the vacuum relief valve closed and it is allowing air to be drawn into the water as it flows by the valve.</b>	<p><b>A.</b> Be sure filter is clean. Backwash to reduce pressure.</p> <p><b>B.</b> If it's an older system, check for debris or scale in the mouth of the vacuum relief valve and clean if necessary.</p> <p><b>C.</b> Use the 2-way valve on the return line to throttle the flow back to produce more back pressure on the system.</p>
<b>SOME OF THE SOLAR PANELS ARE WARM TO THE TOUCH WHILE OTHERS ARE COOL TO THE TOUCH</b>	<b>1. There is not equal flow through all of the panels. Warm panels indicate low water flow. Install issue.</b>	<p><b>A.</b> Be sure filter is clean. Backwash to reduce pressure.</p> <p><b>B.</b> The pump may not be providing enough water to the solar system. Check water flow using a flow meter. Increase pump horsepower if needed to maintain recommended flow.</p> <p><b>C.</b> If there is a suction type cleaner in the pool, remove it. If this eliminates the problem, use it only when the solar system is off.</p>
	<b>1. There is not equal flow through all of the panels. Warm panels indicate low water flow. Pump issue.</b>	<p><b>A.</b> If the system is a single row array and there is adequate flow, use the 2-way valve on the return line to throttle the flow back to produce more back pressure on the system. This will even out the flow through the panels. If the array contains more panels than the maximum recommended on page 7 of this manual, change the array to a double row or single row split feed as show in (Fig. 10.2 and 10.4).</p> <p><b>B.</b> If the system is a double row or a single row split feed array and there is adequate flow, install a ball valve on the return side of the set of panels. Back the flow through these panels and force more water through the warmer panels. If any section of the array contains more panels than the maximum recommended on page 9 of the manual, make changes as needed to correct this.</p>





## 17. Troubleshooting - Cont.

PROBLEM.	CAUSE	SOLUTION
<b>THE AREA LEAKS BETWEEN THE HEADERS AT THE PLASTIC PANEL CLAMPS</b>	1. PPC latch is not tight enough to seal the joint.	Slide the latch farther across the connection between top and bottom half of the clamp.
	2. PPC is not seated squarely in grooves.	Disassemble PPC and verify that the gasket is seated properly.
<b>THERE IS A PIN HOLE LEAK IN ONE OF THE RISER TUBES</b>	1. If it's a new installation, it may be a manufacturing defect. TROUBLESHOOTING - CONT - 36	Contact your distributor for warranty repair information.
	2. Riser tubes are rubbing on roof surface.	Contact distributor for a repair kit and adjust the spacer bars to prevent future damage.
	3. Birds or squirrels have damaged the tubes.	Contact distributor for a repair kit and adjust the spacer bars to prevent future damage.
<b>THE 3-WAY OR BALL VALVE WILL NOT TURN</b>	Internal parts need to be lubricated or replaced.	If the valve has a grease fitting, turn it clockwise to inject grease into valve then turn the diverter past the grease fitting to spread the grease. If the grease fitting is dry, fill it with silicone grease. If there is not a fitting, disassemble valve and lubricate with silicone grease. Replace worn or broken parts.
<b>THE AUTOMATIC CONTROL SYSTEM IS NOT WORKING</b>	<b>Various</b>	Consult the manual for the automatic system you have.
<b>THE WATER COMING FROM THE SOLAR SYSTEM IS NOT AS WARM AS IT SHOULD BE</b>	1. The water is flowing too fast through the panels.	Test the water flow rate. Water flow through a single panel should be less than 10 gallons per minute. Adjust the 3-way valve to bypass some of the water.
	2. Seasonal normal operation.	In the cooler months of the year, or on cool, partly cloudy days, temperature rise through the panels may only be 2° or 3°. Use the back of your hand to feel the water temperature difference at the pool return inlet.

## 18. Repair Procedures

**NOTE:** The Swim Joy solar panel is a very durable product, but there are a few steps you should take to protect its longevity.

- (1) Try to avoid walking on the panels. If you cannot avoid it, always wear soft-soled shoes.
- (2) Do not install Swim Joy panels during temperatures lower than 35 degrees.

If any of the riser tubes in a Swim Joy panel should become damaged for any reason, it can be repaired using the (2-3020-029) repair tool kit. The repair tool kit consists of a 1/4" repair chisel, plug insertion tool, and repair plugs. Follow these instructions for repair:

1. Utilizing the repair chisel, cut the damaged riser as close as possible to the header carefully avoiding damaging adjacent riser tube. (The sloped side of the chisel should face away from the header).



2. Spray the shaft of the insert tool and the rubber insert with silicone spray. Insert the tip of the insertion tool into the plug. By holding the plug with one hand and the insert tool with the other, gently stretch the plug. As you do, push the plug all of the way into the header's opening. Stretching the plug first allows for easier insertion into the header.



3. Pull out the insertion tool. Using your fingers or channel-lock pliers, push a poly insert into the plug as far as you can.

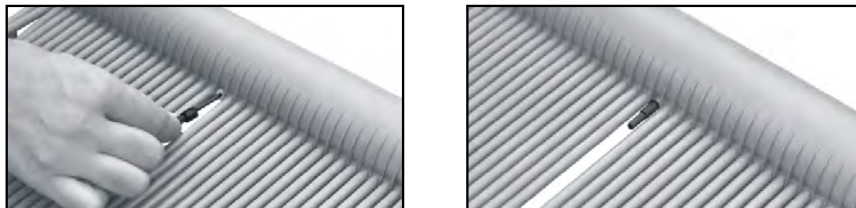

4. Cut the riser tube to the desired length and slide it over the stub of the poly-insert for a straight, eye pleasing fit.

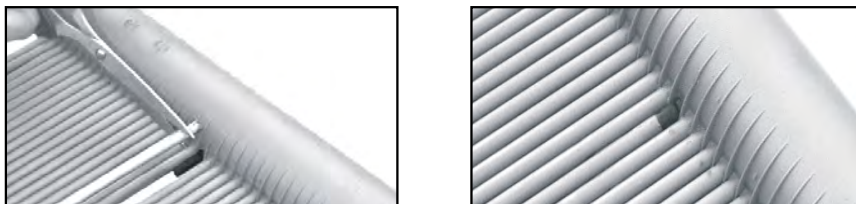

5. REPEAT steps 1-4 for the other end of the riser tube. (At the opposite header).



**TWELVE (12) YEAR LIMITED / LIFETIME LIMITED WARRANTY  
with Freeze Protection**

**WARRANTY:**

This is a twelve (12) year limited warranty issued by Solar Pool Supply, hereinafter referred to as "SPS", covering the Swim Joy collectors ("Collector") and components, when purchased for use on residential or commercial solar heating swimming pools. This warranty is non-transferrable and applies only to the original Purchaser and only to its original installation.

**TWELVE (12) YEAR LIMITED PARTS WARRANTY ON THE SOLAR COLLECTOR AND COMPONENTS:**

When used for its intended purpose and properly maintained, SPS warrants that the collector and components will be free from defect in materials and workmanship in the manufacturing process under normal use for a period of twelve (12) years from the Date of Purchase ("Warranty Period"). During that time, should a Collector or component exhibit a manufacturing defect, SPS will provide a repair method, or at its option replace the defective solar collector with a new solar collector of at least the same quality within a reasonable time and without charge for parts. SPS will be responsible only for the cost of the replacement solar collector. SPS WILL NOT PAY OR BE RESPONSIBLE FOR ANY COSTS ASSOCIATED WITH INSTALLATION, REMOVAL, TRANSPORTATION (SHIPPING), ANY LABOR COSTS OR ANY OTHER COSTS RESULTING FROM THE FAILURE OF THE COLLECTORS OPERATION.

**FREEZE WARRANTY:**

Swim Joy collectors are also warranted against freezing, provided they have been installed according to the published installation manual. The Collectors must be drained from water when the pool pump shuts off in areas where freezing occurs.

**BONUS LIFETIME LIMITED WARRANTY:**

Swim Joy collectors carry a Lifetime Limited Warranty for the original Purchaser for the useful life of the collector. If any Swim Joy collector is found to be defective in material or workmanship subsequent to the initial Twelve (12) Year Warranty, SPS will provide a repair method or at its option replace any solar collector within a reasonable time, so long as the original Purchaser pays fifty percent (50%) of the published MSRP at the time replacement is required. The replacement solar collector will be of at least the same quality as the defective solar collector. SPS WILL NOT PAY OR BE RESPONSIBLE FOR ANY COSTS ASSOCIATED WITH INSTALLATION, REMOVAL, TRANSPORTATION (SHIPPING), ANY LABOR COSTS OR ANY OTHER COSTS RESULTING FROM THE FAILURE OF THE COLLECTORS OPERATION. The Bonus Lifetime Limited Warranty is for the lifetime of the product and to the original Purchaser only.

**EXCLUSIONS & LIABILITY LIMITATIONS:**

When a solar collector is replaced, any replacement item becomes the original Purchaser's property and the defective solar collector becomes the property of SPS. It is the responsibility of the Purchaser to return the defective solar collector to SPS and pay the cost of transportation (shipping). SPS is not required to release any replacement solar collectors until the defective solar collector has been returned and has been found to be defective. SPS shall be released from all obligations under its warranty in the event (a) that the solar collector has been subject to negligence, misuse, accident, other external causes, improper installation, or if repairs or modifications were made by service personnel without proper certification; (b) that the solar collector was not installed and/or operated in accordance with all local fire codes and plumbing codes, ordinances and regulations; (c) that the solar collector has been used in any instance other than its intended purpose or has not been properly maintained; (d) that the solar collector has been damaged by extraordinary or abnormal weather conditions, person or act of God; (e) that the solar collector's serial number label has been altered, effaced or removed.

EXCEPT AS EXPRESSLY PROVIDED HEREIN, SPS DOES NOT MAKE AND HEREBY DISCLAIMS ANY EXPRESS OR IMPLIED WARRANTIES RELATING TO THE COLLECTOR, INCLUDING, BUT NOT LIMITED TO: MERCHANTABILITY OR FITNESS FOR A PARTICULAR PURPOSE, OR ANY WARRANTIES THAT MIGHT ARISE FROM A COURSE OF DEALING, USAGE, OR TRADE PRACTICE.

EXCEPT AS PROVIDED IN THIS WARRANTY AND TO THE FULL EXTENT PERMITTED BY LAW, SPS SHALL NOT BE RESPONSIBLE AND/OR LIABLE FOR DIRECT, SPECIAL, INCIDENTAL, OR CONSEQUENTIAL DAMAGES OR LOSS RESULTING FROM ANY BREACH OF THE ABOVE WARRANTY OR UNDER ANY OTHER LEGAL THEORY.

**PROOF OF PURCHASE:**

It is the responsibility of the original Purchaser to establish the original purchase date for warranty purpose. We recommend that a bill of sale or some other appropriate payment record be kept for that purpose. The following steps should be taken when a warranty claim is being activated:

1. Contact SPS with details of the defect.
2. Provide pictures of the system, including close-up images of the problem areas.



## RESIDENTIAL INSTALLATION MANUAL SWIM JOY SOLAR POOL HEATER



Swim Joy is the first solar pool panel in the world to achieve the elite status of ISO9001:2000 Certified. Relatively few manufacturers have the privilege of placing the ISO 9001:2008 emblem on their products. Only those companies performing at the highest levels in their industries can meet the stringent requirements specified by this demanding international standard. The technical and engineering expertise of Swim Joy and their relentless pursuit of continuous product improvement have earned them the world renowned ISO 9001:2008 certification. Over the two year process necessary to gain certification, their customer service record, product failure rate, and engineering processes were all carefully scrutinized and found deserving of ISO 9001:2008.



The solar energy system described by this manual, when properly installed and maintained, meets or exceeds the minimum standard established by the Solar Rating and Certification Corporation (SRCC). This certification does not imply endorsement or warranty of this product by the SRCC.



An Environmentally Safe Product is one that helps to preserve and protect our environment. The Swim Joy Solar System does just that. An average pool in the United States, when heated by a gas heater, will introduce into our atmosphere 58 tons of CO<sub>2</sub> and 108 pounds of NOX over a ten-year period. A Swim Joy Solar System that is cost effective, durable, and worry-free will introduce no such health hazards into our air. Your Swim Joy system will provide you with natural, safe, and free energy year after year.

**Distributed By:**



**CUSTOMER SERVICE & TECHNICAL SUPPORT**

**PHONE (619) 312-4822**

**CONTACT@SOLARPOOLSUPPLY.COM**