



Inverter/charger

User Manual



UP1000/UP1500

UP2000/UP3000

UP5000

EN

CONTENTS

Important Safety Instructions	1
Disclaimers	2
1. General Information	3
1.1 Overview	3
1.2 Characteristics	4
1.3 Designations of models	5
1.4 Schematic Diagram for Connections	6
2. Installation Instructions	7
2.1 General Installation Notes	7
2.2 Wire Size& breaker	7
2.3 Mounting	9
3. Interface Instruction	13
3.1 Indicator	13
3.2 Buttons	14
3.3 Real-time interface	14
3.4 Setting interface	17
3.5 Other function	19
4. Protection	21
5. Troubleshooting	22
5.1 Fault	22
5.2 Troubleshooting	22
6. Maintenance	23
7. Technical Specifications	24

Important Safety Instructions

Please reserve this manual for future review. This manual contains all instructions about safety, installation, and operation for the inverter/charger.

- Read all the instructions and warnings carefully in the manual before installation.
- Non-safety voltage exists inside the inverter/charger; users must not dismantle it by themselves, contact professional maintenance personnel of our company for maintenance.
- Keep the inverter/charger out the reach of children.
- The inverter/charger is for indoor installation only. Do not install the inverter/charger in a harsh environment such as humid, salt spray, corrosion, greasy, flammable, explosive, or dust accumulative.
- The utility input and AC output have high voltage; please don't touch wire connections.
- Install the inverter/charger in well-ventilated places. Its shell may produce heat during operation.
- It is suggested to install appropriate external fuses/breakers.
- Make sure to switch off all connections with the PV array and the fuse/breakers close to the battery before inverter/charger installation and adjustment.
- Make sure all connections remain tight to avoid excessive heat from a loose connection.
- It's an off-grid inverter/charger, not for an on-grid system.
- This inverter/charger can only be used singly. Parallel or series connections will damage the devices.
- The AC output port is only connected to the load. Therefore, it is strictly forbidden to connect other power sources or utilities. Otherwise, the damage will be caused to the inverter/charger. Also, turn off the inverter/charger before any installation.
- It is strictly forbidden to connect a transformer or a load with a surge power (VA) exceeding the overload power at the AC output port. Otherwise, the damage will be caused to the inverter/charger.

Explanation of symbols: To enable users to use the product efficiently and ensure personal and property safety, please read related literature accompanying the following symbols.

TIPS: Indicates any practical advice for reference.



IMPORTANT: Indicates a critical tip during the operation, if ignored, may cause the device to run in error.



CAUTION: Indicates potential hazards, if not avoided, may cause the device damaged.



WARNING: Indicates the danger of electric shock, if not avoided, would cause casualties.



WARNING HOT SURFACE: Indicates the risk of high temperature, if not avoided, would cause scalds.



Read the user manual carefully before any operation.

Disclaimers

The warranty does not apply to the following conditions:

- Damage is caused by improper use or an inappropriate environment (such as the humid, salt spray, corrosion, greasy, flammable, explosive, dust accumulative, or other severe environments).
- The actual current/voltage/power exceeds the limit value of the inverter/charger.
- Damage caused by working temperature exceeds the rated range.
- Arc, fire, explosion, and other accidents are caused by failure to follow the inverter/charger stickers or manual instructions.
- Disassemble and repair the inverter/charger without authorization.
- Damage is caused by force majeure.
- Damage occurred during transportation or handling.

1. General Information

1.1 Overview

UPower is a new energy storage inverter/charger that integrates utility charging, solar charging, and AC output. The high-performance multi-core chip in the product with the advanced control algorithm brings intelligent management of the system.

As a reliable industrial standard equipment, UPower has quick response speed and excellent high transfer efficiency.

Intelligent adjustment of total charging current from both solar and utility, automatic adjustment is realized via different working modes selection, which ensures to provide power energy supply maximally.

The PV charging module adopts the up-to-date optimized MPPT tracking technology; it can quickly track the PV array's maximum power point in any environment. The MPPT tracking speed and energy transfer efficiency are quite high. The PV and AC charge current can be adjusted manually, which can meet the total charge current limit function. PV & utility charge current ratio distribution. Full electronic protection functions are available.

With a fully digital double closed-loop control, the AC-DC charging unit has extremely high response speed and stability. A wide AC input voltage and charge current limitation can be set. This module has complete protection functions at input and output.

The DC-AC inverter module is based on full digital and intelligent design. It adopts the advanced SPWM technology, outputs the pure sine wave, and converts 24/48VDC to 220/230VAC, suitable for AC loads of household appliances, electric tools, commercial units, electronic audio, and video devices, etc.

With the Utility by-pass charging function, the utility module can provide a power supply to load directly and charge the battery simultaneously. Under utility charge status, the user can choose by-pass mode or inverter output mode. UPower series provides multiple power supply modes, such as solar and utility, to maximize the use of green energy while ensuring electricity supply.

The display module is key for communication. The 4.2 inch LCD presents system status and real-time data; the user can set work parameters easily by four buttons.

Features:

- Full intelligent digital energy storage equipment
- Adjustment function of Utility & Solar charging ratio to meet various applications
- Advanced MPPT tracking technology, Max. tracking efficiency 99.5 %, Max. conversion efficiency 98.5 %
- Advanced all-digital control AC-DC charging modules to realize wide voltage input, high efficiency, and high stability
- Advanced SPWM technology to ensure maximum efficiency up to 95 %^①, and full load efficiency up to 93 %^①
- High output voltage stability: when full load working in the working voltage range of battery, output voltage
- 220V/230V \pm 5%^②, frequency 50/60 \pm 0.1 Hz; voltage& frequency optional
- Advanced voltage, current, and power multi-loop control makes the DC-AC unit has good dynamic response capability, high resistance to surge power, and high operational reliability
- With the function of Utility & Solar charging ratio selection, and total charging current setting
- Four charging modes: Utility priority, Solar priority, Utility & Solar and Solar only

- Two output modes: Battery and Utility
 - Utility charging and inverter output can work at the same time, which avoids the impact of the unstable Utility voltage on the load
 - Rich set of options: charging current, battery type, battery voltage threshold, etc
 - AC output one-key control, which can switch Utility or inverter output on and of, keeping the output of mode can make it convenient while wiring and maintaining on electric-distributions, reducing the standby loss
 - Support cold start and soft start
 - RS485 isolated communication interface with 5V 200mA output, it is easy to access communication devices such as WIFI module
 - PC or mobile phone APP can be used for remote monitoring, management, and setting to meet various remote use of users
 - Optional backlight and buzzer warning selection via PC software
 - With PV reverse polarity, Charging power limit, short circuit, battery reverse polarity protection
 - With Utility input/AC output over-voltage, battery low voltage, power limit, over-current, and short circuit protections
 - With battery low/over voltage protection and temperature compensation etc
 - With internal over-temperature protection and intelligent start-stop function of the fan
 - A variety of accessories can be selected according to the user's requirements
- ① **UP1500 and above models: testing result under 25°C environment temperature, rated input voltage, and resistive load**
- ② **In battery discharging mode Output tolerance is 220V \pm 5% or 230V -10%~+5% for 24V and 48V input; and 220V -6%~+5% or 230V -10%~+5% with 12V battery input**

1.2 Characteristics

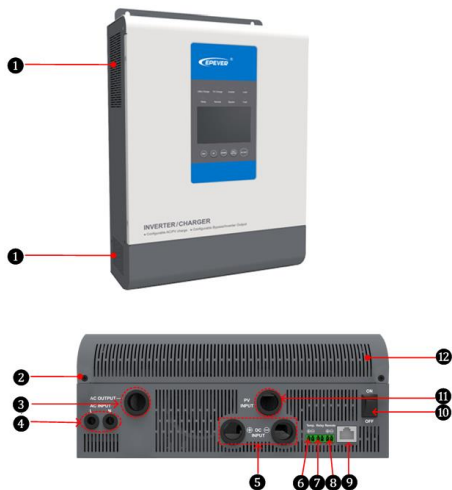

①	Ventilation	⑦	Dry contact interface
②	M4 Screw (2 pcs)	⑧	Remote interface
③	AC output terminals	⑨	RS485 interface(5VDC/200mA)
④	Utility input terminals	⑩	Inverter/charger switch
⑤	Battery input terminals	⑪	PV input terminals
⑥	RTS* interface	⑫	Terminals cover



Temperature Sensor

(Model:RT-MF58R47K3.81A)



★ Connect the temperature sensor, the inverter/charger is compensated according to the ambient temperature.

● RS485 Interface

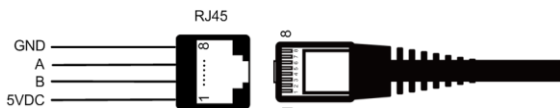

RJ45 interface pin define is shown below:

Pins	Define	Pins	Define
1	5VDC	5	RS-485-A
2	5VDC	6	RS-485-A
3	RS-485-B	7	GND
4	RS-485-B	8	GND

1.3 Designations of models

UP 3000 - M 2 1 4 2

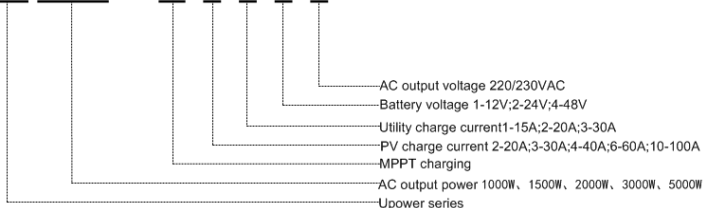

2. Installation Instructions

2.1 General Installation Notes

- Please read the entire installation instructions to get familiar with the installation steps before installation.
- Be very careful when installing the batteries, especially flooded lead-acid batteries. Please wear eye protection, and have fresh water available to wash and clean if any battery acid contact.
- Keep the battery away from any metal objects, which may cause a short circuit of the battery.
- Explosive acid battery gases may come out from the battery during charging, so make sure ventilation condition is good.
- Ventilation is highly recommended if mounted in an enclosure. Never install the inverter/charger in a sealed enclosure with flooded batteries! Battery fumes from vented batteries will corrode and destroy the inverter/charger circuits.
- The lead-acid battery is only recommended. For other kinds, please refer to the battery manufacturer.
- Loose connections and corroded wires may result in high heat that can melt wire insulation, burn surrounding materials, or even cause a fire. Ensure tight connections and use cable clamps to secure cables and prevent them from swaying in motion.
- Select the system cables according to $5A/mm^2$ or less current density following Article 690 of the National Electrical Code, NFPA 70.
- The inverter/charger is for indoor installation only. Do not install the inverter/charger in a harsh environment such as humid, salt spray, corrosion, greasy, flammable, explosive, or dust accumulative.
- High voltage still exists inside the inverter/charger after switching off the power switch. Do not turn on or touch the internal units and conduct the associated operation only after discharging the electric capacity.
- Do not place the inverter/charger in a damp, oily, inflammable, and explosive or severe environment with a large amount of dust accumulation.
- Prohibit reverse connection at DC input end; otherwise, it may damage the equipment, or unpredictable danger will occur.
- The utility input and AC output are of high voltage, do not touch the wire connection.

2.2 Wire Size & breaker

The wiring and installation methods must follow all national and local electrical code requirements.

➤ **Recommended wire and circuit breaker of PV**

Model	PV wire size	Breaker
UP1000-M3212	10mm ² /8AWG	2P—63A
UP1000-M3222	10mm ² /8AWG	2P—63A
UP1500-M3222	10mm ² /8AWG	2P—63A
UP2000-M3322	10mm ² /8AWG	2P—63A
UP3000-M3322	10mm ² /8AWG	2P—63A
UP3000-M6322	16mm ² /5AWG	2P—100A
UP3000-M2142	6mm ² /10AWG	2P—32A
UP3000-M6142	16mm ² /5AWG	2P—100A
UP5000-M6342	16mm ² /5AWG	2P—100A
UP5000-M8342	25mm ² /4AWG	2P—125A
UP5000-M10342	25mm ² /4AWG	2P—125A

NOTE: When the PV modules are connected in series, the PV array's open-circuit voltage must not exceed the max. PV input voltage at 25°C environment temperature.

➤ **Recommended wire of Utility**

Model	Utility wire size
UP1000-M3212	2.5mm ² /14AWG
UP1000-M3222	2.5mm ² /14AWG
UP1500-M3222	2.5mm ² /14AWG
UP2000-M3322	4mm ² /12AWG
UP3000-M3322	6mm ² /10AWG
UP3000-M6322	6mm ² /10AWG
UP3000-M2142	6mm ² /10AWG
UP3000-M6142	6mm ² /10AWG
UP5000-M6342	10mm ² /8AWG
UP5000-M8342	10mm ² /8AWG
UP5000-M10342	10mm ² /8AWG

NOTE: The utility input has the circuit breaker already, and there is no need to add any more.

➤ **Recommended wire and circuit breaker of battery**

Model	Battery wire size	Breaker
UP1000-M3212	16mm ² /6AWG	2P—100A
UP1000-M3222	16mm ² /6AWG	2P—100A
UP1500-M3222	16mm ² /6AWG	2P—100A
UP2000-M3322	25mm ² /4AWG	2P—125A
UP3000-M3322	35mm ² /2AWG	2P—200A
UP3000-M6322	35mm ² /2AWG	2P—200A
UP3000-M2142	16mm ² /6AWG	2P—100A
UP3000-M6142	16mm ² /6AWG	2P—100A
UP5000-M6342	35mm ² /2AWG	2P—200A

UP5000-M8342	35mm ² /2AWG	2P—200A
UP5000-M10342	35mm ² /2AWG	2P—200A

NOTE: Type of circuit breaker is selected based on the inverter's non-independent connection at the battery end where there is no another inverter connected.

➤ **Recommended wire and circuit breaker for AC output**

Model	AC wire size	Breaker
UP1000-M3212	2.5mm ² /14AWG	2P—10A
UP1000-M3222	2.5mm ² /14AWG	2P—10A
UP1500-M3222	2.5mm ² /14AWG	2P—10A
UP2000-M3322	2.5mm ² /14AWG	2P—16A
UP3000-M3322	4mm ² /12AWG	2P—25A
UP3000-M6322	4mm ² /12AWG	2P—25A
UP3000-M2142	4mm ² /12AWG	2P—25A
UP3000-M6142	4mm ² /12AWG	2P—25A
UP5000-M6342	6mm ² /10AWG	2P—40A
UP5000-M8342	6mm ² /10AWG	2P—40A
UP5000-M10342	6mm ² /10AWG	2P—40A



- The wire size is only for reference. Suppose a long-distance exists between the PV array and the inverter/charger or between the inverter/charger and the battery. In that case, larger wires shall be used to reduce the voltage drop and improve the system performance.
- The above wire and the circuit breaker size are recommended only; please choose the appropriate wire and circuit breaker according to the practical situation.

NOTE: The cable lugs refer to the cardboard in the package.

2.3 Mounting

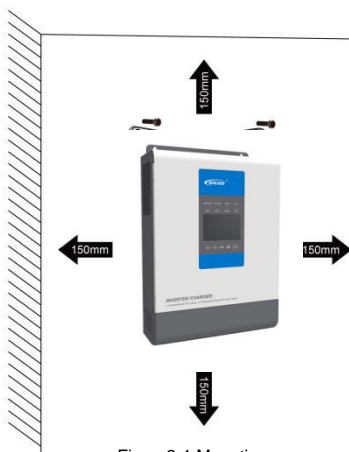

Figure2-1 Mounting

Installation steps:

Step1: Determination of Installation Location and heat-dissipation Space

When installing the inverter/charger, ensure enough air flowing through the heat sink. Please leave at least 150mm clearance away from the upper and lower edges. Please see Figure 2-1: Mounting.



WARNING: Risk of explosion!

Never install the inverter/charger with flooded batteries in a sealed enclosure! Do not install the device in a confined area where battery gas can accumulate.

Step 2: Take down the terminal protective cover

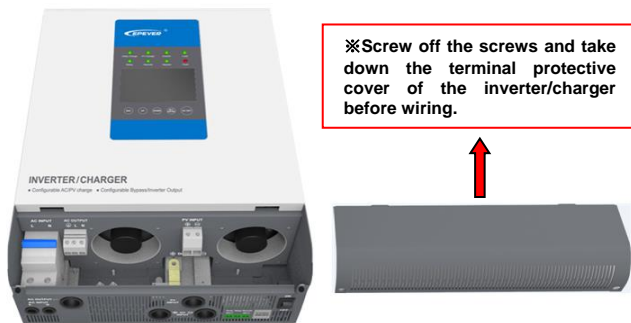

Figure2-2 Take down the cover

Step 3: Wiring

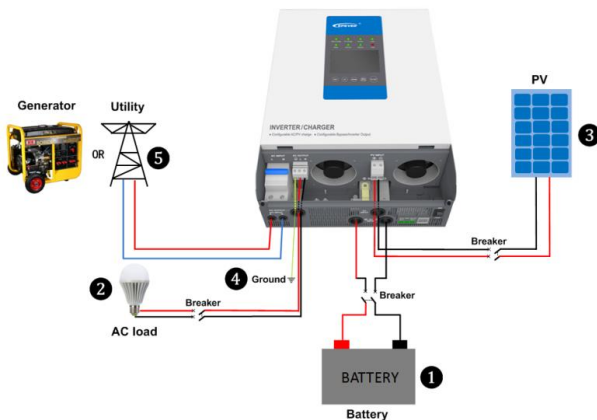

Figure 2-3Wiring Diagram

Connect the system in order of battery  → load  → PV array  → Ground → Utility



following Figure 2-3: Wiring Diagram. Disconnect the system in reverse order.



- Danger, High-voltage! Utility input, AC output, and PV array will produce dangerous voltage. Ensure to disconnect the circuit breaker/ fuse before wiring.
- Do not turn on the circuit breaker/ fuse when wiring, and at the same time, ensure that the poles' wirings are correctly connected.
- A circuit breaker must be installed at the battery end. For selection, refer to Section 2.3, "Wire and Circuit Breaker."



If the inverter/charger is to be used in an area with frequent lightning strikes, installing an external surge arrester at the PV input is recommended.

➤ Grounding

A grounding connection must be made when the utility is connected to the inverter/charger. The inverter/charger has a dedicated grounding terminal, as shown in Fig. 2-3, and the grounding must be reliable. The grounding wire has to stay consistent with Recommended wire for AC output. The grounding point shall be as close as possible to the inverter/charger; the grounding wire shall be as short as possible.

➤ AC output, Ground, and PV wiring terminal use way:

- ① When wiring, do not close the circuit breaker. It is necessary to use a slotted screwdriver to unscrew the screws for connecting their corresponding wires.
- ② When removing the wirings, first the integrated machine must stop working. Then the screws shall be unscrewed by using a slotted screwdriver to dismantle their corresponding wires.

Step 4: Install the terminal protective cover

Step 5: Connect accessory

- Connect the remote temperature sensor cable (model: RTS300R47K3.81A)

Connect one end of the remote temperature sensor cable to the interface ⑥ and place the other end close to the battery.

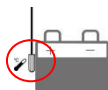

Connect the temperature sensor, the inverter/charger is compensated according to the ambient temperature.

- Connect the remote temperature sensor cable (model: RTS300R47K3.81A)
- **Connect the accessories, monitor the system status, and set the parameters via PC software or APP software.**

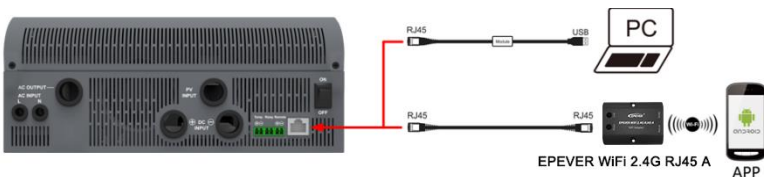

(1)PC software

www.epever.com——Inverter Monitor(UP)

(2)Mobile APP software (Android)

www.epever.com——UPower

Step 6: Recheck if the wire connection is correct

Step 7: Power on the inverter/charger

- ① Connect the circuit breaker at the battery end.
- ② Turn on the switch, then the inverter indicator is on.
- ③ Turn on the breaker of PV array and Utility.
- ④ Turn on the AC load when the AC output is normal.









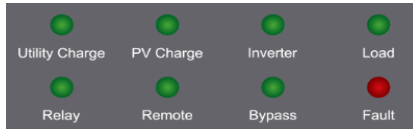

- When supplying power for different AC loads, it is recommended to turn on the load with a large impulse current. And then turn on the load with a smaller impulse current after the load output is stable.
- If the inverter/charger is not operating properly or the LCD or the indicator shows an abnormality, please refer to 5 "Troubleshooting" or contact our after-sales personnel

NOTE: The installation steps and accessory list also refer to the cardboard in the package.

3. Interface Instruction







3.1 Indicator



Indicator	Color	Status	Instruction
	Green	OFF	No utility input
		On Solid	Utility connection normal but no charging
		Slowly Flashing(0.5Hz)	Utility charging
		Fast Flashing(2.5Hz)	Utility charge module fault
	Green	OFF	No PV input
		On Solid	PV connection normal but no charging
		Slowly Flashing(0.5Hz)	PV charging
		Fast Flashing(2.5Hz)	PV charge module fault
	Green	OFF	Inverter turns off
		On Solid	Inverter turns on By-pass
		Slowly Flashing(0.5Hz)	Inverter output
		Fast Flashing(2.5Hz)	Inverter fault
	Green	OFF	No-load output
		On Solid	Load output
	Green	OFF	Dry contact turns off
		On Solid	Dry contact turns on
	Green	OFF	Input voltage(3.3~12VDC)
		On Solid	No Input voltage
	Green	OFF	Inverter output
		Slowly Flashing(0.5Hz)	Utility output
	Red	OFF	Device normal
		On Solid	Device fault

3.2 Buttons







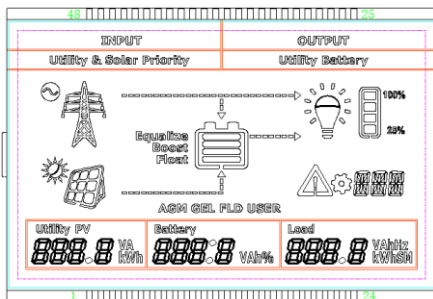





Operation	Instruction
Press the  button	Exit the current interface
Press the  button and hold on 2s	Clear the faults
Press the  button	Browse interface: Up/Down
	Setting interface: Up/Down
Press the  button	Switch to "Browse Parameter Column" Confirm the setting parameters
Press the  button and hold on 2s	Switch the "Real-Time Interface" over to "Set Browse Interface"
	Switch the "Set Browse Interface" over to "Parameter Setting Interface"
Press the  button and hold on 2s	Inverter ON/OFF

3.3 Real-time interface



Note: The display screen can be viewed clearly when the angle between the end-user's horizontal sight and the display screen is within 90°. If the angle exceeds 90°, the information on the display screen cannot be viewed clearly.

Icon	instruction	Icon	instruction
	Utility connecting and input		PV connecting and input
	No Utility connecting Utility connecting but no input		No PV connecting PV connecting but no input

	Load ON		Load OFF
	Load power 8~25%		Load power 25~50%
	Load power 50~75%		Load power 75~100%

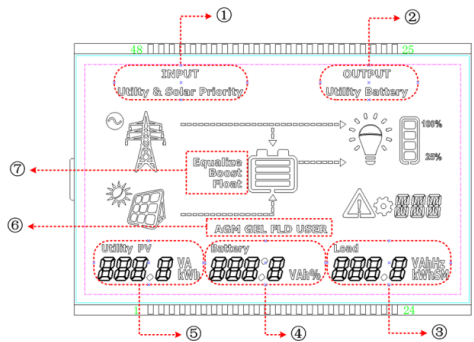

Item	Setting	Content
①	INPUT	Solar priority Utility priority Utility & solar Solar
②	OUTPUT	Battery Utility
③	Load	AC output voltage AC output current AC output power AC output frequency
④	Battery	Battery voltage Max. charging current (PV charging current+ Utility charging current) Battery temperature Battery SOC
⑤	PV	PV input voltage PV charging current PV charging power PV charge energy
	Utility	Utility input voltage Utility charging current Utility charging power Utility charge energy
⑥	Battery Type	AGM GEL FLD

		USER
⑦	Battery charging stage	Float Boost Equalize(28 th each month)

① INPUT

★Solar priority(Default)

The battery is charged in solar priority mode. When the battery voltage is lower than "Auxiliary Module ON Voltage (V_{AON})," the utility starts charging. When the battery voltage reaches "Auxiliary Module OFF Voltage (V_{AOF})," the utility stops charging.

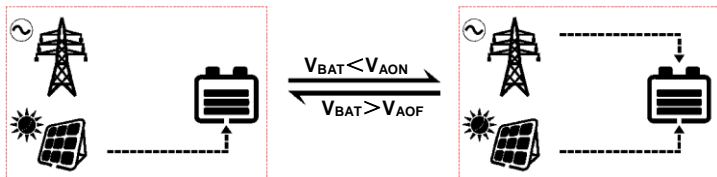

★Utility priority

The battery is charged in utility priority mode. When the battery voltage is lower than the "Auxiliary Module ON Voltage (V_{AON})," the solar starts charging the battery. And when the battery voltage reaches the "Auxiliary Module OFF Voltage (V_{AOF})," the solar stops charging.

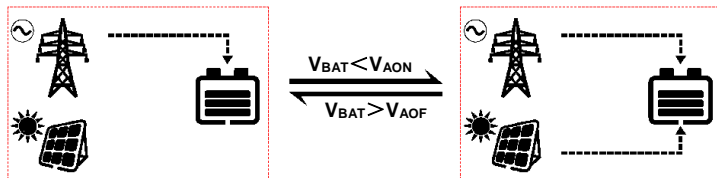

★Utility & solar

Utility & solar charge the battery

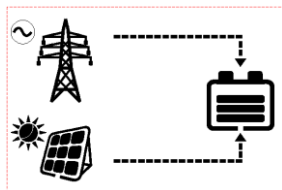

★Solar

Solar charges the battery

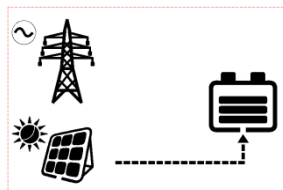

② OUTPUT

★Battery

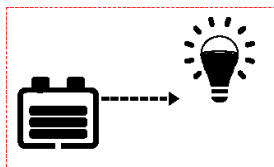

★Utility(Default)

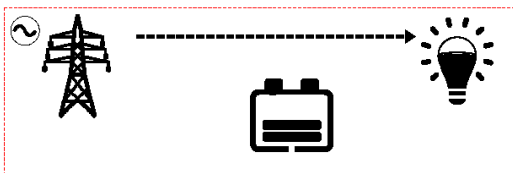

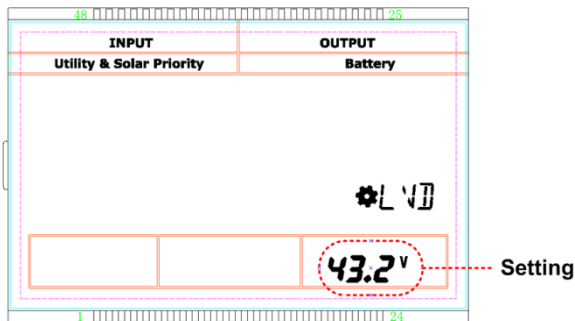

3.4 Setting interface





1) Common interface for common user

Operation:

Step1: Press the  button and hold on 2s at the real-time interface to go to the common interface.

Step2: Press the  button and hold on 2s at the setting parameter interface and choose the parameters.

Step3: Press the  button to set the parameter, and press this button again for confirmation.

Step4: Press the  button to exit the setting interface.

Setting:

Item	LCD	Instruction	Default	Range
1	BTP	Battery type	AGM	AGM GEL FLD USER
2	CSP	Charge source priority	Solar priority	Solar priority Utility priority Utility & solar Solar
3	OSP	Output source priority	Utility	Battery Utility

4	TMU	Temperature unit	°C	°C/°F
5	BLT	Backlight time	30S	30S/60S/100S(Always-on)
6	BAS	Buzzer alarm switch	ON	ON/ OFF
7	LVD	Low voltage disconnect voltage	10.8V*	User 10.5~11.3V* step size 0.1V*
8	LVR	Low voltage reconnect voltage	12.5V*	User 12.0~13.0V* step size 0.1V*



★ The voltage parameter is at 25°C, 12V system, and twice in 24V system, quadruple in 48V system.



When the output mode is battery priority, the battery voltage is lower than the low-voltage disconnect voltage (adjustable). The system switch to the utility power supply for the load.

2) Advanced interface for engineers

Operation:

Step1: Press the  +  button and hold on 2s under the real-time interface.

Step2: Press the  button and hold on 2s under the setting parameter interface.

Step3: Press the  button to enter the parameter.

Step4: Press the  button to exit the setting interface.

Setting:

Item	LCD	Instruction	Default	Range
9	BCT	Boost Charging Time	30min	30/60/120/180min
10	BCV	Boost Charging Voltage	AGM:14.4V* GEL:14.2V* FLD:14.6V* USER:14.4V*	User 12.5~14.8V* Step size 0.1V*
11	BVR	Boost Voltage Reconnect	13.2V*	User: 12.5~14.0V* Step size 0.1V*
12	FCV	Float Charging Voltage	13.8V*	User: 13.0~14.0V* Step size 0.1V*
13	OVR	Over Voltage Reconnect Voltage	15.0V*	User: 14.5~15.5V* Step size 0.1V*
14	OVV	Over Voltage Disconnect Voltage	16.0V*	User: 15.5~16.1V* Step size 0.1V*
15	AOFF	Auxiliary module OFF voltage	14.0V*	User: 12.0~14.8V* Step size 0.1V*
16	AON	Auxiliary module ON voltage	12.0V*	
17	DOV	Dry contact ON voltage	11.1V*	User: 10.8~12.0V* Step size 0.1V*
18	DOFF	Dry contact OFF voltage	12.0V*	User:12.0~13.25V* Step size 0.1V*
19	MCC	Max. charging current	60.0A*	15.0~60.0A*
20	PSM	Power saving mode	OFF	ON/OFF

21	EFA	Clear fault	OFF	ON/OFF
22	QEL	Clear the accumulated energy	OFF	ON/OFF
23	TBC	Total battery capacity	600AH	100~4000AH Step size 100AH
23	VER	Software version	U-1.0	—

★The voltage parameter is at 25°C, 12V system, and twice in 24V system, quadruple in 48V system.

The following rules must be observed when modifying the parameter values in User for lead-acid battery.

I. Over Voltage Disconnect Voltage > Charging Limit Voltage ≥ Equalize Charging Voltage ≥ Boost Charging Voltage ≥ Float Charging Voltage > Boost Reconnect Charging Voltage.

II. Over Voltage Disconnect Voltage > Over Voltage Reconnect Voltage

III. Low Voltage Reconnect Voltage > Low Voltage Disconnect Voltage ≥ Discharging Limit Voltage.

IV. Under Voltage Warning Reconnect Voltage > Under Voltage Warning Voltage ≥ Discharging Limit Voltage.

V. Boost Reconnect Charging voltage > Low Voltage Reconnect Voltage.

◆For the inverter/charger of different power, the current setting range is not the same; see Technical Parameters for details.

NOTE:

15/16: Stop/restore auxiliary module charging voltage

Only when the charging mode is Solar priority or Utility priority will the auxiliary module charging voltage be effective.

20: Power saving mode

When the switch is on the "Saving" side, the inverter will enter into the Saving Mode. It will shut off the output if the load value is less the 70W. Then restart and detect the power of the load again after 10s. If the load is more than 70W, the inverter will turn on the output. Otherwise, it will shut off output. It cycles like this. So please don't use the saving mode if the load is smaller than 70W.

21: Clear the faults

In a short circuit or overload caused to AC output, the fault can be cleared out.

3.5 Other function

1) Output voltage & frequency switch

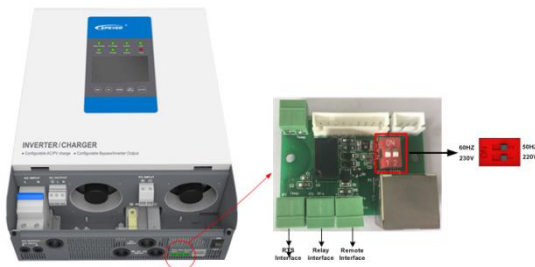

- When Switch 1 is in "ON," the output voltage is selected as 230VAC, and on the contrary as 220VAC;
- When Switch 2 is in "ON," the output frequency is selected as 60Hz, and on the contrary, like 50Hz.



If the output frequency or voltage of the inverter/charger is to be reset; it is required to turn off the inverter/charger and power on the unit after setting.

2) Dry contact interface

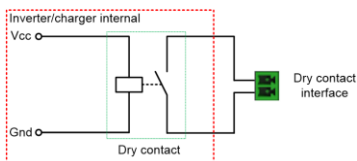

Working principle: When the battery voltage reaches the dry contact ON voltage (DON), the dry contact is connected, for its coil is energized. The dry contact can drive resistive loads of no more than 125VAC /1A, 30VDC/1A.

3) Remote interface

Remote interface input voltage (3.3~12V)

(1) The input voltage V_i is within 2.5~ 10s, the AC output state is reversed (when the AC is formerly in the output state, now it is in the no-output state; when the AC is formerly in the no-output state, now it is in output state;)

(2) The input voltage V_i is greater than 10s; the AC is in the output state all the time till the input voltage V_i disappears.

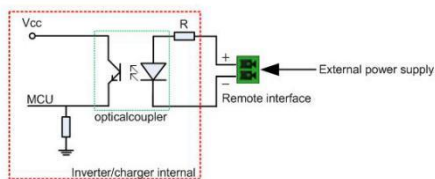

If it is to change the range of input voltage, it can be realized by changing R's resistance value.

4. Protection

Protection	Instruction				
PV limit Current	When the charging current of the PV array exceeds its rated current, it will be charged at the rated current. NOTE: When the PV modules are in series, ensure that the PV array's open-circuit voltage does not exceed the "maximum PV open-circuit voltage." Otherwise, the inverter/charger may be damaged.				
PV short circuit	When PV is not charging and short circuit, the inverter/charger is not damaged.				
PV Reverse Polarity	Fully protect against PV reverse polarity, correct the wire connection to resume normal operation. NOTE: The inverter/charger will be damaged when the PV array straight polarity and the PV array's actual operating power are 1.5 times greater than the rated charge power!				
Night Reverse Charging	Prevent the battery from discharging through the PV module at night.				
Utility input overvoltage	When the utility voltage exceeds 280V, it will stop utility charging/discharging.				
Utility input under-voltage	When the utility voltage is less than 160V, it will stop utility charging/discharging.				
Battery overvoltage	When the battery voltage reaches the set point of Over Voltage Disconnect Voltage, the inverter/charger will stop charging the battery to protect the battery from being overcharged to break down.				
Battery Over Discharge	When the battery voltage reaches the Low Voltage Disconnect Voltage set point, the inverter/charger will stop discharging the battery to protect the battery from being over-discharged to break down.				
Load output Short Circuit	It will immediately close the output in the occurrence of a short-circuit. Hereafter the output is automatically recovered in time delay (the first time delay for 5s, the second time delay for 10s, the third time delay for 15s).				
Load output Overload	Overload	1.2	1.5	1.8	2.0
	Continuance	15min.	30S	10S	5S
	Recover 3 times	The first time delay for 5s, the second time delay for 10s, the third time delay for 15s			
Device overheating	The inverter/charger will stop charging/discharging when the internal temperature is too high and will restore charging/discharging when the temperature is recovered to normal.				

5. Troubleshooting

5.1 Fault

Module	Code	Fault	battery frame blink	indicator	Buzzer	Fault indicator			
Battery	BLV	Battery low voltage	Flashing	—	—	—			
	BOV	Battery over voltage							
	BOD	Battery over-discharge							
	NVE	Nominal voltage error							
	LTP	Low temperature							
PV charging module	OTP	Over-temperature (PV charge module)	—	PV charge Fast Flashing	Alarm	On Solid			
	CFA	Communication Fault Alarm							
Utility charging module	IOV	Input overvoltage							
	ILV	Input low voltage							
	OTP	over temperature (Utility charge module)							
	CFA	Communication Fault Alarm							
Inverter output module	OVA	Output voltage abnormal		inverter Fast Flashing					
	OSC	Output short circuit							
	OOL	Output overload							
	OTP	Over-temperature							
	CFA	Communication fault alarm							

5.2 Troubleshooting

Fault	Troubleshooting
Battery over voltage	Check if battery voltage too high, and disconnect solar modules.
Battery over-discharge	When the battery voltage resume to or above LVR point (low voltage reconnect voltage), or change the battery by other ways
Battery overheating	The inverter/charger will automatically turn the system off. But while the battery temperature declines to be below overheating recovery temperature value, the inverter/charger will work normally.
Device overheating	The inverter/charger will automatically turn the system off. But while the device temperature declines to be below overheating recovery temperature value, the inverter/charger will work normally.
Output overload	①Please reduce the number of AC loads. ②Restart the device or CFA of setting interface change to ON.
Output short circuit	①Check carefully loads connection, clear the fault. ②Restart the device CFA of setting interface change to ON.

6. Maintenance

The following inspections and maintenance tasks are recommended at least two times per year for the best performance.

- Make sure the inverter/charger is firmly installed in a clean and dry ambient.
- Make sure no block on airflow around the inverter/charger. Clear up any dirt and fragments on the radiator.
- Check all the naked wires to ensure insulation is not damaged for serious solarization, frictional wear, dryness, insects or rats, etc. Repair or replace some wires if necessary.
- Tighten all the terminals. Inspect for loose, broken, or burnt wire connections.
- Check and confirm that LED or LCD is consistent with the actual operating. Pay attention to any troubleshooting or error indication. Then, take the necessary corrective action.
- Confirm that all the system components are ground connected tightly and correctly.
- Confirm that all the terminals have no corrosion, insulation damaged, high temperature, or burnt/discolored sign. Then, tighten terminal screws to the suggested torque.
- Check for dirt, nesting insects, and corrosion. If so, clear up in time.
- Check and confirm the lightning arrester is in good condition. Replace a new one in time to avoid damaging the inverter/charger and even other equipment.



WARNING: Risk of electric shock!

Ensure that all the power is turned off before the above operations, and then follow the corresponding inspections and operations.

7. Technical Specifications

Item	UP1000-M3212	UP1000-M3222	UP1500-M3222	UP2000-M3322	UP3000-M3322	UP3000-M6322
Nominal battery voltage	12VDC	24VDC				
Battery input voltage range	10.8~16VDC	21.6~32VDC				
Inverter output						
Continuous output power	800W	800W	1200W	1600W	2400W	2400W
Output power (15min.)	1000W	1000W	1500W	2000W	3000W	3000W
Overload power(5s)	1600W	1600W	2400W	3200W	4800W	4800W
Max. surge power	2000W	2000W	3000W	4000W	6000W	6000W
Output voltage range	220V(-6%~+5%) 230V(-10%~+5%)	220VAC(±5%), 230VAC(-10%~+5%)				
Output frequency	50/60±0.1Hz					
Output mode	Single-phase					
Output wave	Pure Sine Wave					
Load power factor	0.2-1(Load power≤Continuous output power)					
Distortion THD	≤3%(12V or 24V resistive load)					
Max. efficiency	91%	94%	95%	95%	95%	95%
Transfer time	20mS(resistive load)					
Utility charging						
Utility input voltage range	160VAC~280VAC(Working voltage range) 170VAC~270VAC(Utility starting voltage range)					
Max. utility charge current	20A	20A	20A	30A	30A	30A
Solar charging						
Max. PV open circuit voltage	60V* 46V*	100V* 92V*				150V* 138V*
Max. PV input power	390W	780W	780W	780W	780W	1500W
Max. PV charging current	30A	30A	30A	30A	30A	60A
Equalization voltage	14.6V	29.2V				
Boost voltage	14.4V	28.8V				
Float voltage	13.8V	27.6V				

Tracking efficiency	≤99.5%					
Charging conversion efficiency	≤98%					
Temperature compensate coefficient	-3mV/°C/2V (Default)					
Others						
No load consumption	≤1.2A	≤0.6A	≤0.6A	≤0.8A	≤0.8A	≤0.8A
Enclosure	IP30					
Relative humidity	< 95% (N.C.)					
Environment temperature	-20°C~50°C (100% input and output with no derating)					
Altitude	<5000m(Derating to operate according to IEC62040 at a height exceeding 1000m)					
Mechanical Parameters						
Dimension(H x W x L)	386×300×126mm			444×300×126mm		518×310×168mm
Mounting size	230mm					
Mounting hole size	Φ8mm					
Weight	7.3kg	7.3kg	7.4kg	8.5kg	9.2kg	14.9kg

★At minimum operating environment temperature

◆At 25°C environment temperature

Item	UP3000-M2142	UP3000-M6142	UP5000-M6342	UP5000-M8342	UP5000-M10342
Nominal battery voltage	48VDC				
Battery input voltage range	43.2~64VDC				
Inverter output					
Continuous output power	2400W	2400W	4000W	4000W	4000W
Output power (15min.)	3000W	3000W	5000W	5000W	5000W
Overload power(5s)	4800W	4800W	8000W	8000W	8000W
Max. surge power	6000W	6000W	10000W	10000W	10000W
Output voltage range	220VAC(±5%), 230VAC(-10%~+5%)				
Output frequency	50/60±0.1Hz				
Output mode	Single-phase				
Output wave	Pure Sine Wave				
Load Power factor	0.2-1(Load power≤Continuous output power)				
Distortion THD	≤3%(24V or 48V resistive load)				
Max. efficiency	95%				

Transfer time	20mS(resistive load)				
Utility charging					
Utility input voltage range	160VAC~280VAC(Working voltage range) 170VAC~270VAC(Utility starting voltage range)				
Max. utility charge current	15A	15A	30A	30A	30A
Solar charging					
Max. PV open circuit voltage	150V* 138V*			200V* 180V*	
Max. PV input power	1040W	3000W	3000W	4000W	5000W
Max. PV charging current	20A	60A	60A	80A	100A
Equalization voltage	58.4V				
Boost voltage	57.6V				
Float voltage	55.2V				
Tracking efficiency	≤99.5%				
Charging conversion efficiency	≤98%				
Temperature compensate coefficient	-3mV/°C/2V (Default)				
Others					
No load consumption	≤0.6A	≤0.6A	≤0.8A	≤0.8A	≤0.8A
Enclosure	IP30				
Relative humidity	< 95% (N.C.)				
Environment temperature	-20°C~50°C(100% input and output with no derating)				
Altitude	<5000m(Derating to operate according to IEC62040 at a height exceeding 1000m)				
Mechanical Parameters					
Dimension	444×300×126mm	518×310×168mm	605×315×178mm		
Mounting size	230mm				
Mounting hole size	Φ8mm				
Weight	7.3kg	14.7kg	16.6kg	17.5kg	17.8kg

★At minimum operating environment temperature

◆At 25°C environment temperature

Any changes without prior notice! Version number: V2.3

HUIZHOU EPEVER TECHNOLOGY CO., LTD.

Tel: +86-752-3889706

E-mail: info@epever.com

Website: www.epever.com