

1.5 Gal (5.7L) SH Srvr, INF SERIES

Height: 14.5" Width: 9.1" Depth: 13.3"
(36.8cm) (23.1cm) (33.8cm)



- BUNN-exclusive Soft Heat technology automatically docks the server to the brewer (or remote warming station), supplying controlled heat to brewed coffee at ideal holding temperatures while maintaining optimal flavor for longer periods
- New 1.5gal (5.7L) Soft Heat servers are completely modernized and ergonomic, of lighter weight and greater energy efficiency, yet are still constructed of durable stainless steel to withstand the demands of a busy serving environment
- The rounded design and wider top mean that the inside is easier to access and clean
- Can utilize programmed recipe/batch-based holding times and temperatures
- Integrated sight gauge assembly provides at-a-glance volume level
- The serving unit alerts staff when freshness has expired or the server is empty
- New side-mounted pail-style handle makes transporting more stable for serving, emptying, and cleaning

Agency:



Specifications

Product #: 27850.0200

Finish: Stainless

Additional Features

Holding Capacity

English	Metric
192 oz.	5.7 L

 WARNING:



BUNN® reserves the right to change specifications and product design without notice. Such revisions do not entitle the buyer to corresponding changes, improvements, additions or replacements for previously purchased equipment. For most current specifications and other info visit bunn.com.

Last Updated:
03/30/2023

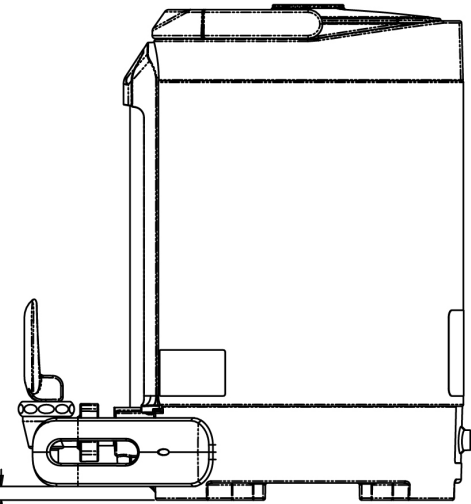
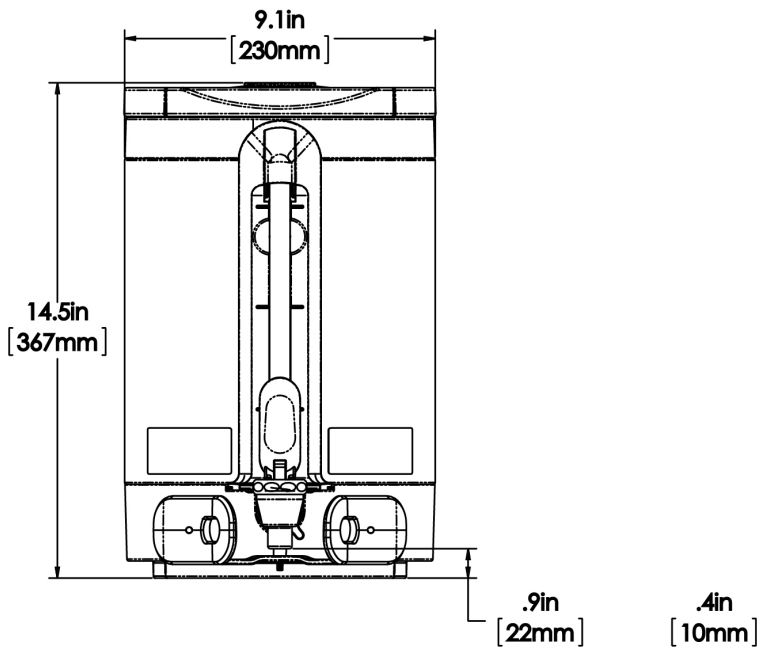
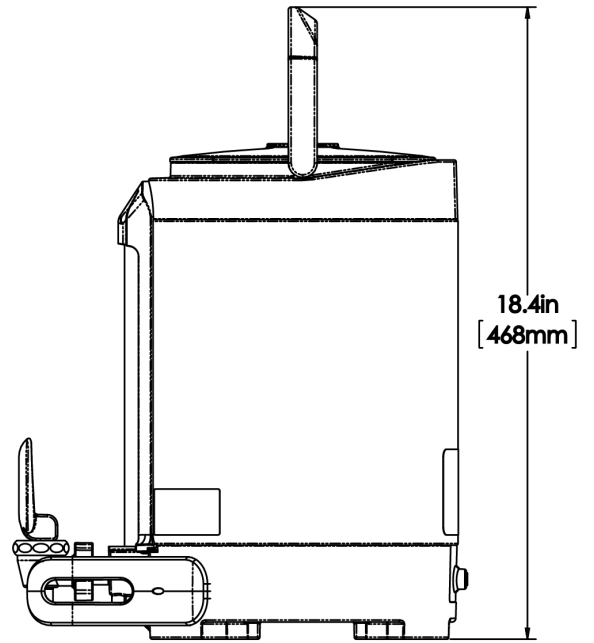
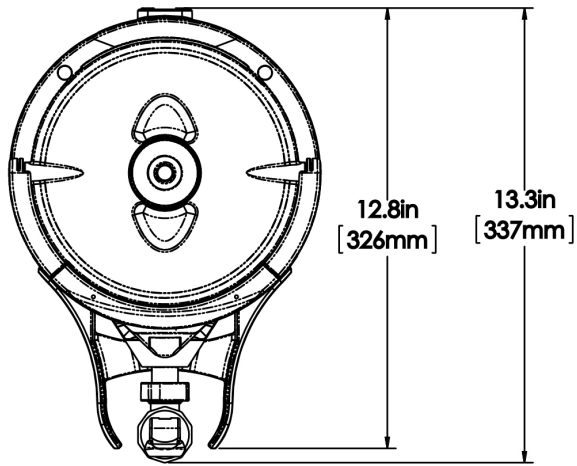

	Unit			Shipping				
	Height	Width	Depth	Height	Width	Depth	Weight	Volume
English	14.5 in.	9.1 in.	13.3 in.	17.4 in.	11.6 in.	17.5 in.	8.450 lbs	2.046 ft ³
Metric	36.8 cm	23.1 cm	33.8 cm	44.1 cm	29.5 cm	44.5 cm	3.833 kgs	0.058 m ³



BUNN® reserves the right to change specifications and product design without notice. Such revisions do not entitle the buyer to corresponding changes, improvements, additions or replacements for previously purchased equipment. For most current specifications and other info visit bunn.com.

Last Updated:
03/30/2023

Related Products & Accessories: 1.5 Gal (5.7L) SH Srvr, INF SERIES(27850.0200)



1SH STAND, 120V INF
SERIES

Product #: 27825.0200



2SH STAND, 120V INF
SERIES

Product #: 27875.0200



ICB TWIN SH, 120/240V
SST

Product #: 51200.0100



ICB TWIN SH, 120/240V
BLK/SST

Product #: 51200.0101

HANDLE, FAUCET 3.0
SHORT ORANGE

Product #: 51315.0003



KIT, DRIP TRAY INF
TWIN SH

Product #: 53452.0000



KIT, DRIP TRAY SINGLE
SH

Product #: 53452.0001

HOLDER, SIGN SH
SERVER INF SERIES
UPPER

Product #: 53683.0003



KIT, PUSH STYLE SST
HANDLE ADAPTER

Product #: 57480.0000

BRUSH, FOAM .512 OD
X 9.65 LG

Product #: 57892.0000



BUNN® reserves the right to change specifications and product design without notice. Such revisions do not entitle the buyer to corresponding changes, improvements, additions or replacements for previously purchased equipment. For most current specifications and other info visit bunn.com.

Last Updated:
03/30/2023

Model Compatibility: 1.5 Gal (5.7L) SH Srvr, INF SERIES(27850.0200)

Serving and Holding selections are currently unavailable. Please contact your sales representative to find out more information.



BUNN® reserves the right to change specifications and product design without notice. Such revisions do not entitle the buyer to corresponding changes, improvements, additions or replacements for previously purchased equipment. For most current specifications and other info visit bunn.com.

Last Updated:
03/30/2023