

WARING COMMERCIAL

Immersion Blender

WSB50 12" shaft

WSB55 14" shaft

WSB60 16" shaft

WSB65 18" shaft

WSB70 21" shaft

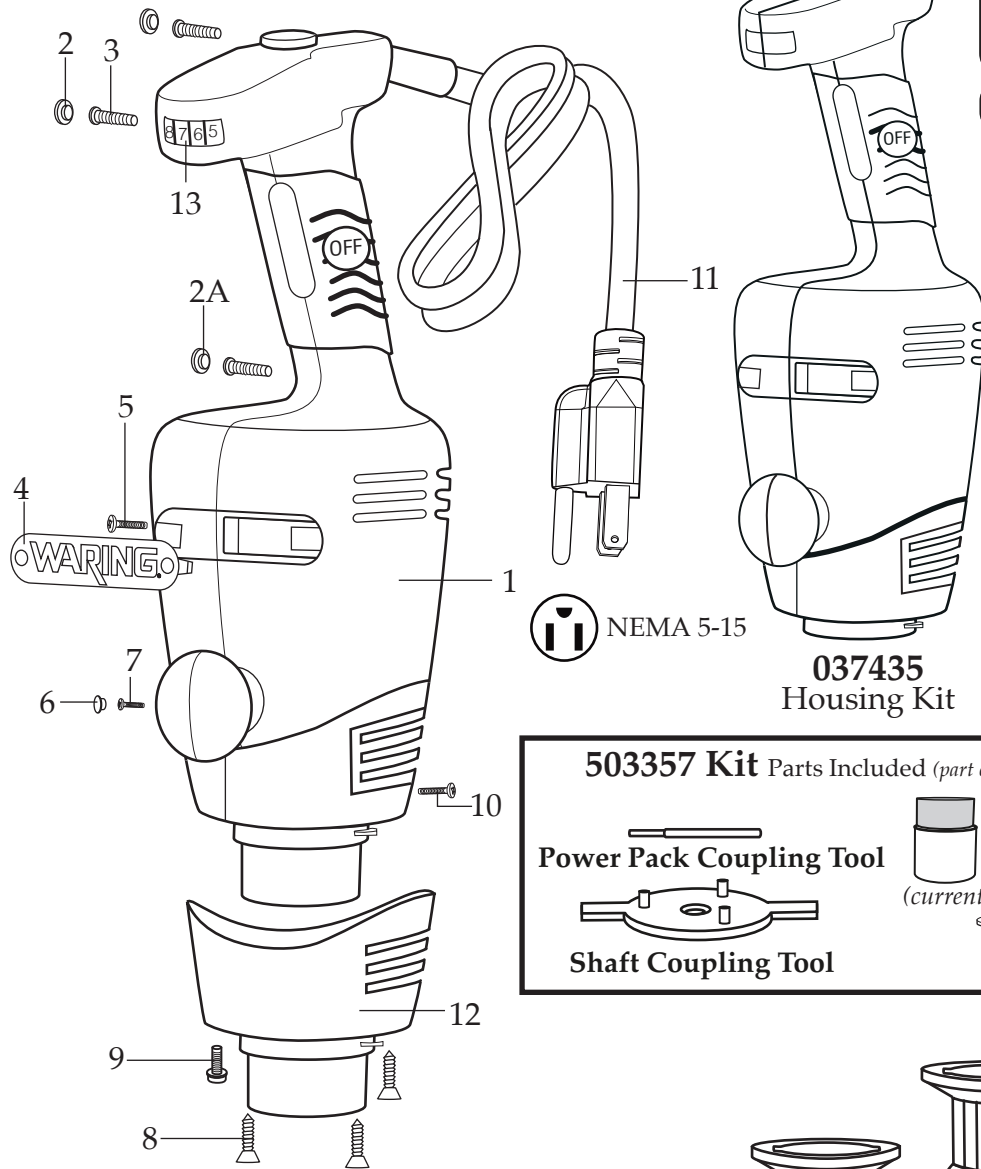

 NEMA 5-15

037435
Housing Kit

503357 Kit Parts Included *(part changed in 2007)*



Power Pack Coupling Tool



(current)



(old style)



Shaft Coupling Tool

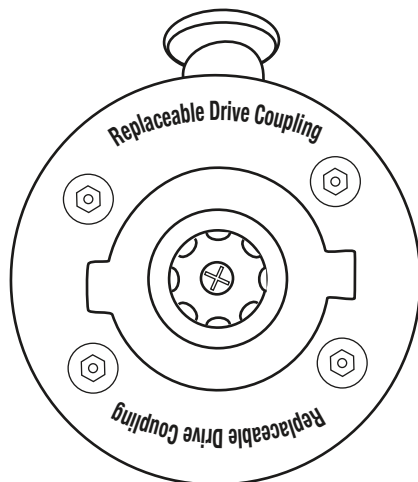

To use the 503357 kit the bottom of your Power Pack must look like this.

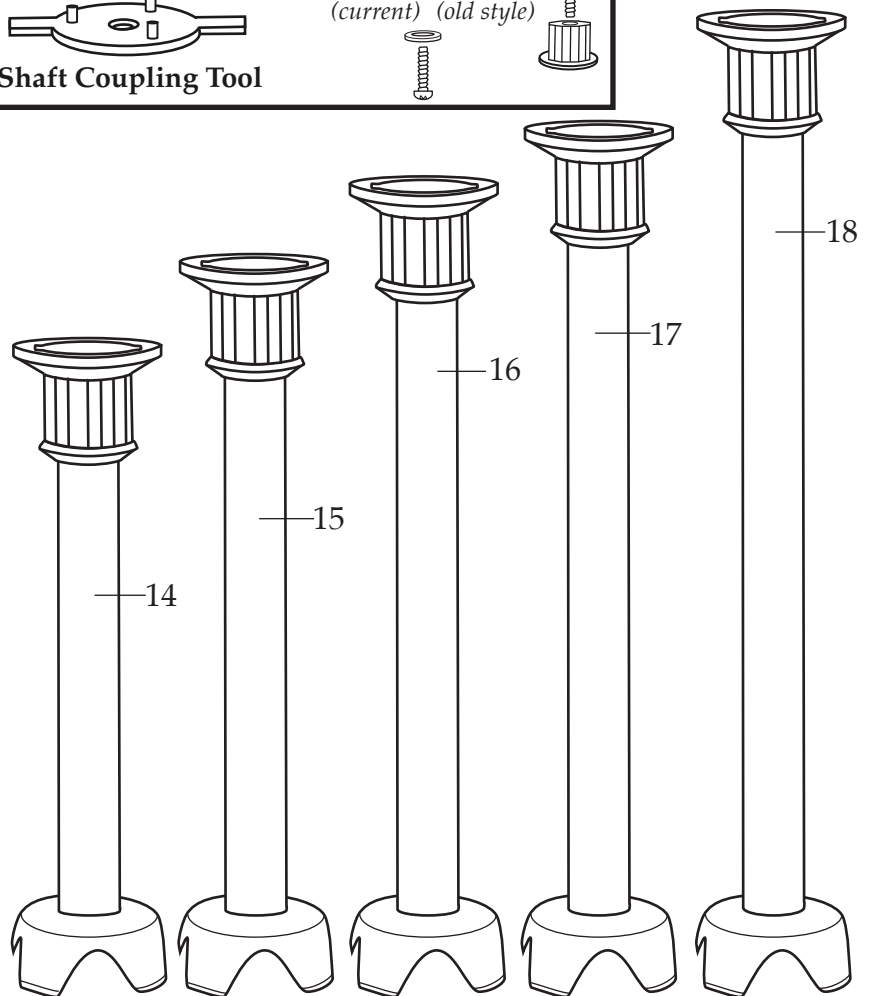

Catalog/Model

WSB50
 WSB55
 WSB60
 WSB65
 WSB70

WSB

Waring Factory Service Center
 314 Ella T. Grasso Ave.
 Torrington, CT 06790
 Tele. 1-800-269-6640

Fax 860-496-9017
 www.waringcommercialproducts.com

Illustration#	Part#	Description
1	502955	WSB Power Pack
2	029839	Hole Plug (2 required)
2A	029905	Hole Plug
3	029840	Screw (3 required)
4	029841	Nameplate Panel
5	029842	Screw
6	029843	Hole Plug
7	029844	Screw
8	029845	Screw (3 required)
9	029846	Screw
10	029844	Screw
11	030442	Cord Set
12	030440	Housing Cover
13	032650	Speed Control Knob
14	502956	12" Shaft Assembly with Blade
15	502957	14" Shaft Assembly with Blade
16	502958	16" Shaft Assembly with Blade
17	503002	18" Shaft Assembly with Blade
18	503003	21" Shaft Assembly with Blade

Internal Components

