

smonex

# ONE SMART BOX

XAOR01

Compatible with Xia®  
Assembly Guide



NOT A CHILDREN TOY  
AGE 14+

Xia® is a registered trademark of Far Off Games LLC. Any mention of Xia® is for reference purposes only. ALL RIGHTS RESERVED by their respective trademark holders. No challenge to any intellectual property rights is intended or implied by representations of compatibility and no endorsements of any of our products by any other company is implied or represented.

# XIA Organizer XA0R01

Compatible with Xia®  
Assembly Guide

## Tips and tricks

- To assemble each tray you need a wood glue for extra strength. (We recommend Titebond 2 Wood Glue or Beacon 527)
- Please make sure you assembled each tray correctly before gluing it together.
- Use stationery knife to cut the bits that connect details to the frame.
- Remove the details from the frame with a rotational motion along the axis formed by the bits you just cut.
- Use stationery knife to remove all the remaining connection bits.
- Leave your finished insert overnight to dry completely.
- Use a hairdryer for easier removal of the protective covering from acrylic details. Just heat the acrylic surface a little to remove the covering much easier!

## Assembly Supplies



Wood-glu



Stationery knife



Hammer



Cotton swab



Hairdryer

**IMPORTANT:** Assemble each tray one by one. Please DO NOT take all the parts out of the sheets and mix them. Even though some parts look similar, they are not interchangeable.

smonex

# XIA Organizer XA0R01

Compatible with Xia®  
Assembly Guide

## Created for:

- Xia: Legends of a Drift System
- Xia: Embers of a Forsaken Star
- Xia: Missions and Powers
- Xia: Legends of a Drift System
- Sellsword Mk II

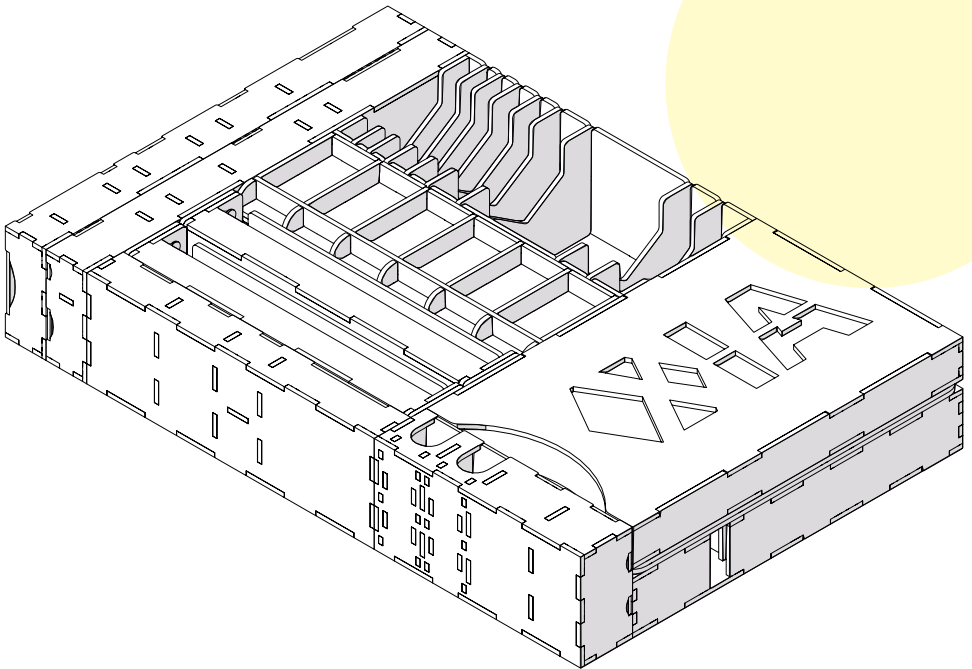

If something is damaged or broken, please do not return the whole set. Contact us directly on email [info@smonex.com](mailto:info@smonex.com) or our website [smonex.com](http://smonex.com). Any questions or issues with the Smonex products, we'll do our best to help you. We want our customers to be completely satisfied.

This is a non-licensed product. ALL RIGHTS RESERVED by their respective trademark holders. No challenge to any intellectual property rights is intended or implied by representations of compatibility and no endorsements of any of our products by any other company is implied or represented.



# XIA Organizer XAOR01

Compatible with Xia®  
Assembly Guide

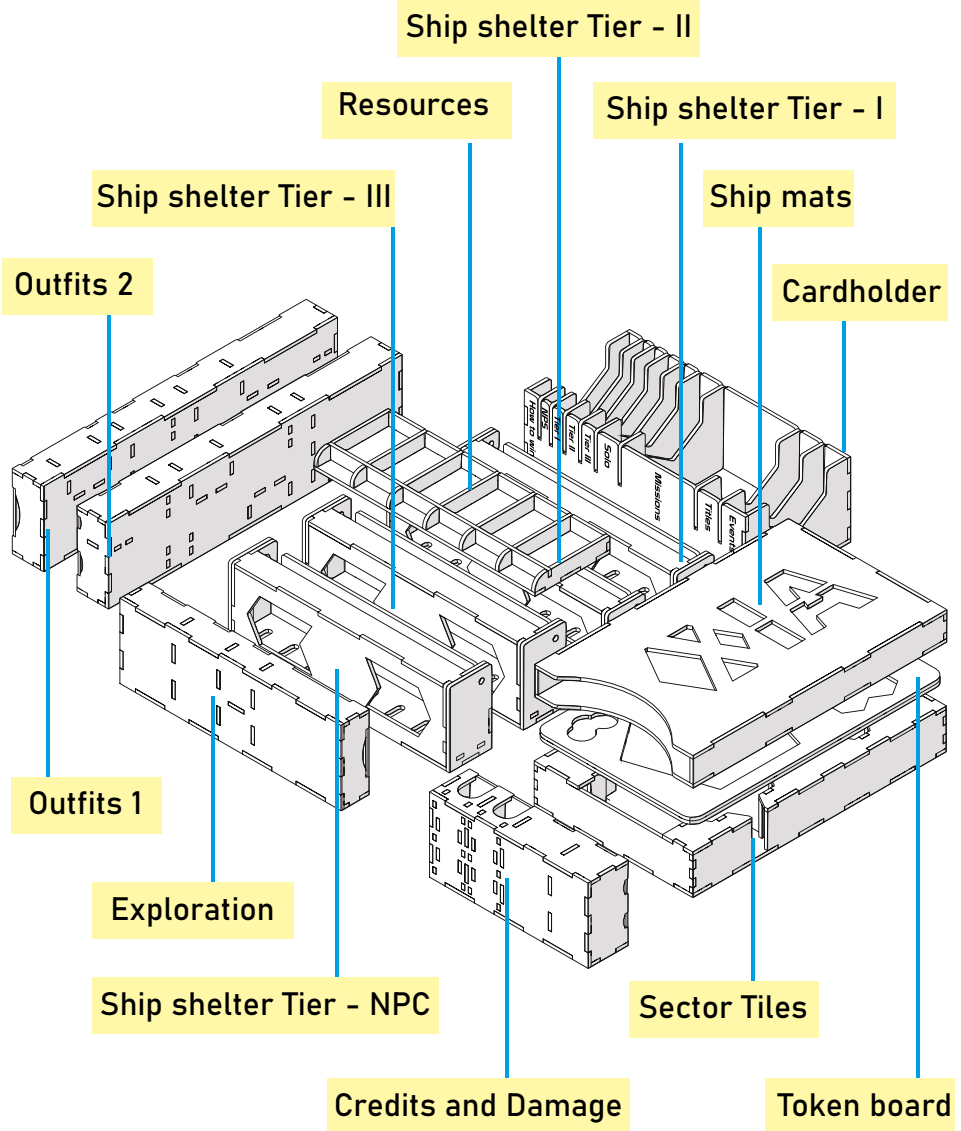

This is a non-licensed product. ALL RIGHTS RESERVED by their respective trademark holders. No challenge to any intellectual property rights is intended or implied by representations of compatibility and no endorsements of any of our products by any other company is implied or represented.



# XIA Organizer XAOR01

Compatible with Xia®

## Assembly Guide

- Brief assembly instructions:**
1. Unpack and arrange the sheets in order.
  2. Compare details on the sheets with details in the pictures of the guide.
  3. Study the pictures of unassembled product.
  4. Start your assembly, taking the necessary parts out of the sheets in a certain order.

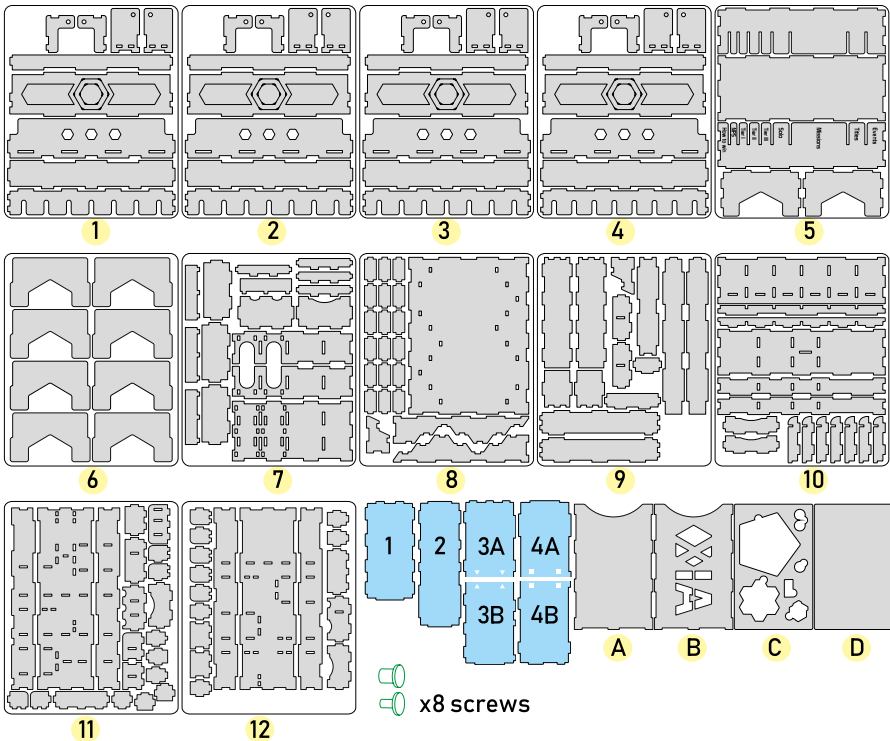

### Legend:

- highlighted details to be extruded
- details not used in this assembly
- ➡ details to be connected without glue
- ➞ details to be screwed
- ➞ details to be glued

### Components:

- 12 sheets extrusion molds
- 6 acrylic lids
- 8 screws
- 4 large parts (A, B, C, D)
- Assembly guide
- 1 sandpaper for stripping parts



# XIA Organizer XA0R01

Compatible with Xia®  
Assembly Guide

## Ship shelter Tier - I, II, III, NPC

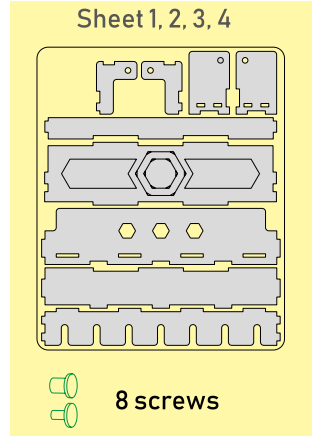
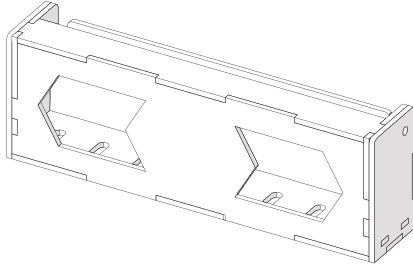

Each sheet 1, 2, 3, 4 allows you to assemble ships shelters of the appropriate tiers.  
Make sure the engraving located outside

Step 1

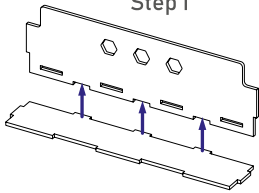

Step 2

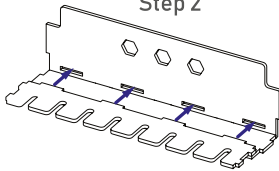

Step 3

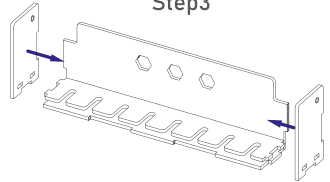

After step 3, until the glue has completely dried, insert your ships in the appropriate cells

Step 4

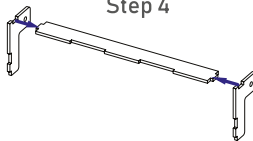

Step 5

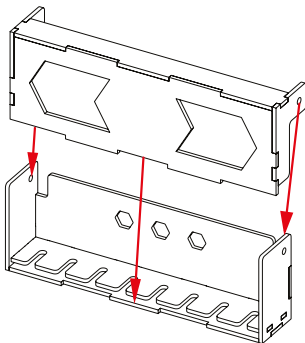
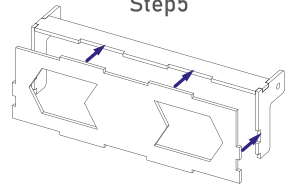

Step 6

In the box you will find 8 screws that need to be screwed in 2 units into each ship shelter

Step 7

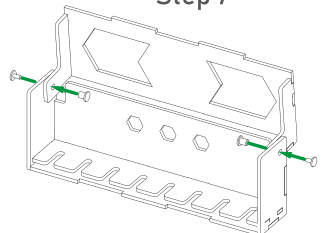



# XIA Organizer XA0R01

Compatible with Xia®  
Assembly Guide

## Cardholder

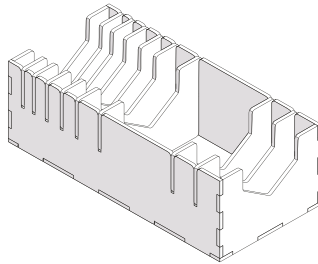

Sheet 5, 6

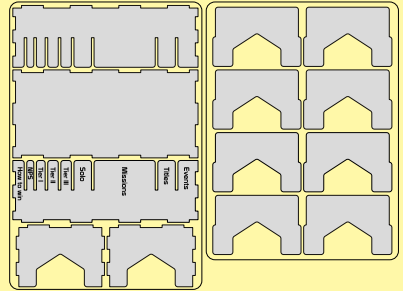

Intended for card storage and sorting. Make sure that engraving is on the topside of the box

Step 1

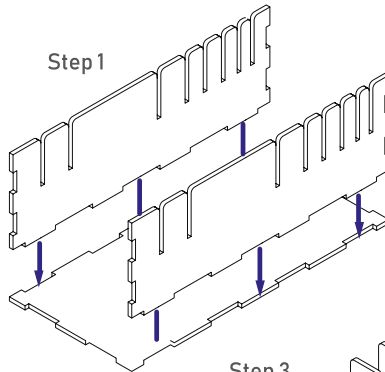

Step 2

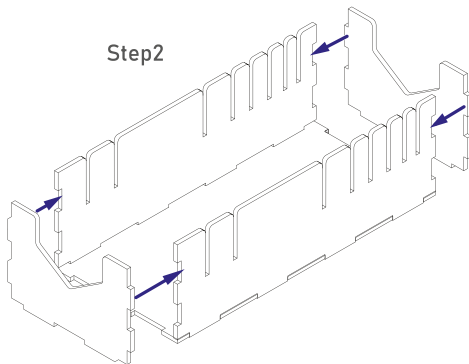

Step 3

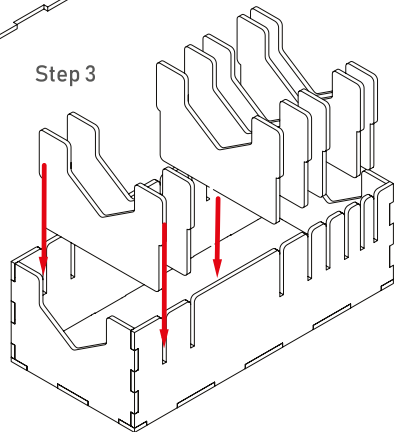

This is a non-licensed product. ALL RIGHTS RESERVED by their respective trademark holders. No challenge to any intellectual property rights is intended or implied by representations of compatibility and no endorsements of any of our products by any other company is implied or represented.



# XIA Organizer XA0R01

Compatible with Xia®  
Assembly Guide

## Credits and Damage

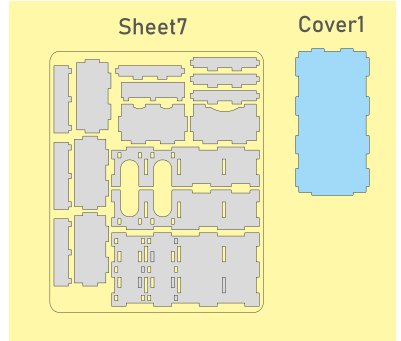
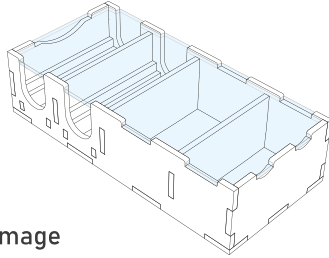

Intended for credit, damage  
and ice damage storage

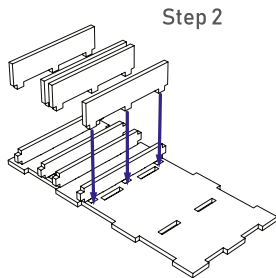

Step 2

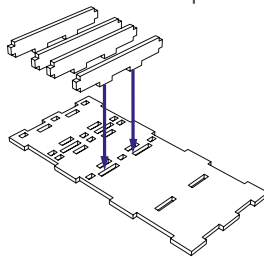

Step 1

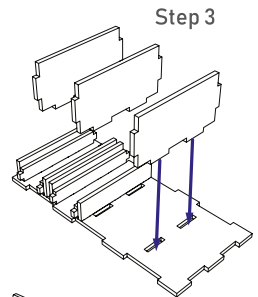

Step 3

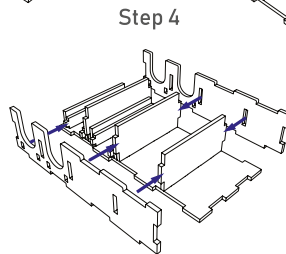

Step 4

After step 4, until the glue has completely dried, insert Cover 1 in the right slots. Do not take protective cover-up off

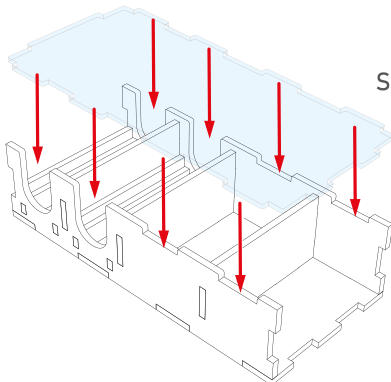

Step 5

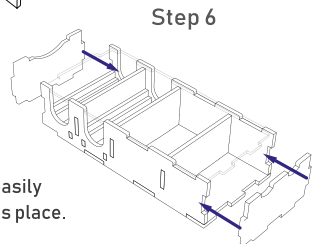

Step 6

After step 5, until the glue has completely dried, make sure that Cover 1 is easily removed and put back in its place. Only after that remove the protective cover-up





# XIA Organizer XA0R01

Compatible with Xia®  
Assembly Guide

## Sector Tiles

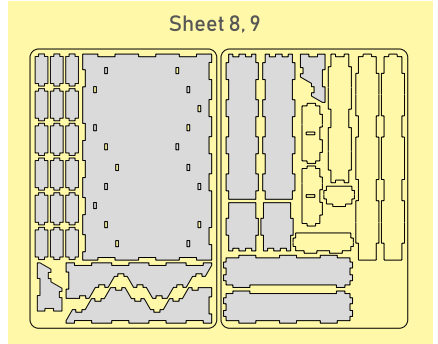
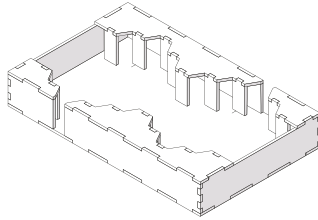

Intended for sector tiles storage

Step 1

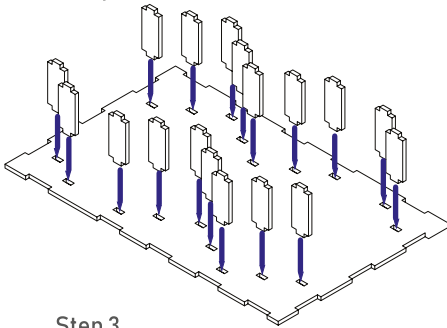

Step 2

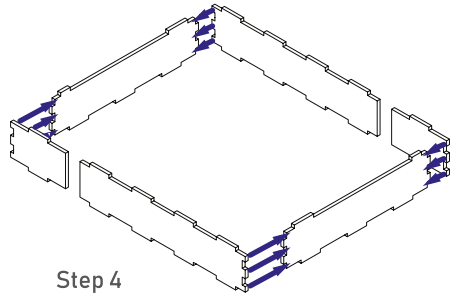

Step 3

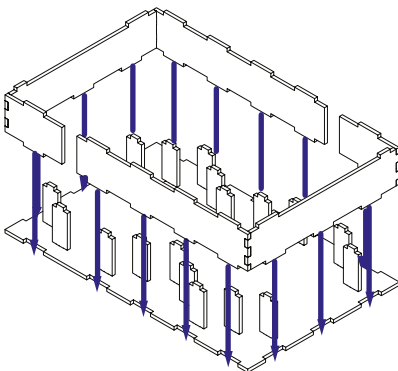

Step 4

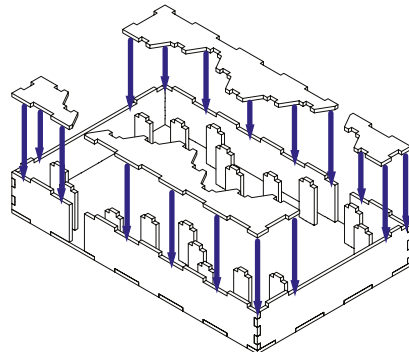



# XIA Organizer XAOR01

Compatible with Xia®  
Assembly Guide

## Ship mats

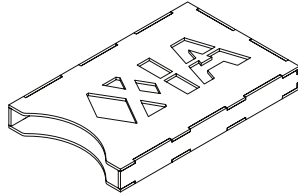

Intended for ship mats storage

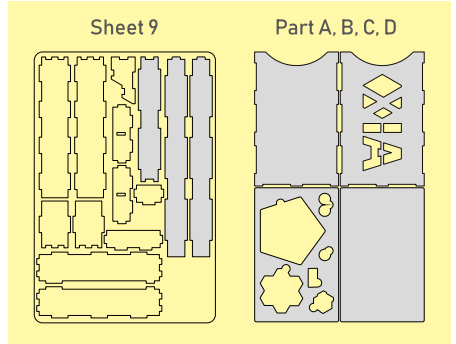

### Step 1

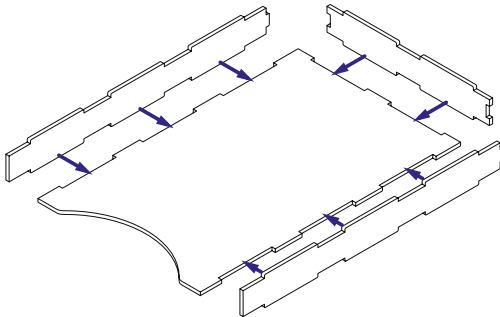

### Step 2

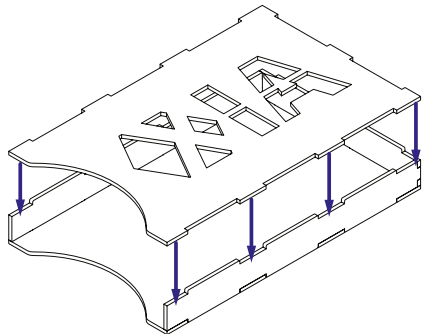

## Token board

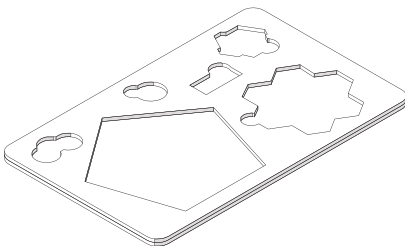

Intended for tokens storage

### Step 1

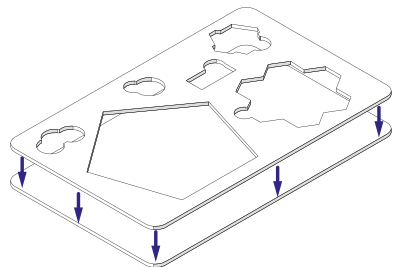



# XIA Organizer XAOR01

Compatible with Xia®  
Assembly Guide

## Exploration

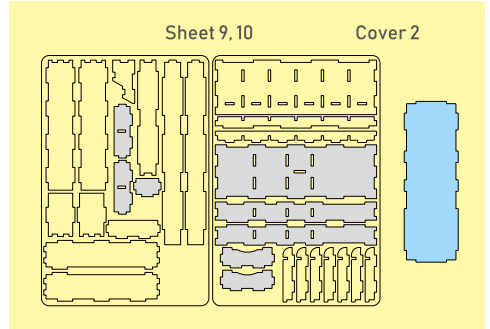
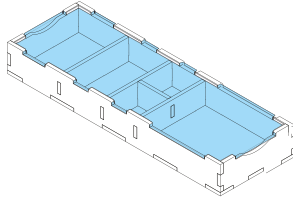

Intended for exploration  
tokens, etc. storage

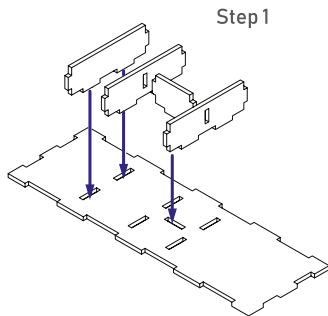

Step 1

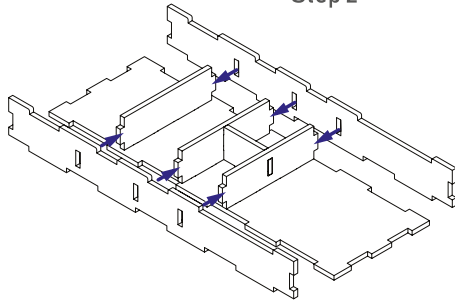

Step 2

Step 3. Until the glue has completely  
dried, insert Cover 2 in the right  
slots. Do not take protective  
cover-up off

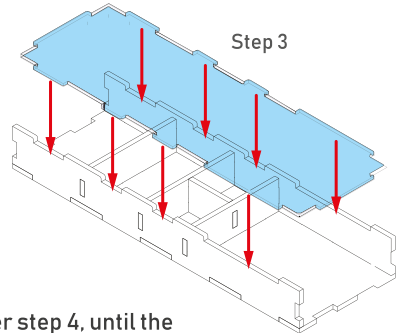

Step 3

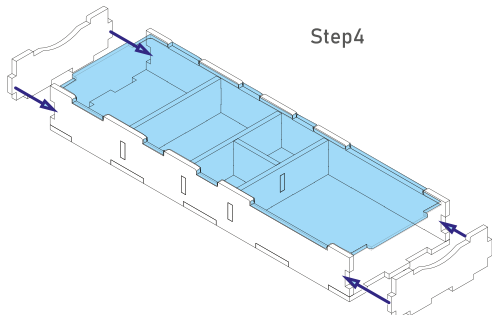

Step 4

After step 4, until the  
glue has completely dried,  
make sure that Cover 2 is  
easily removed and put back  
in its place. Only after that  
remove the protective  
cover-up



# XIA Organizer XA0R01

Compatible with Xia®  
Assembly Guide

## Resources



Intended for  
resource storage

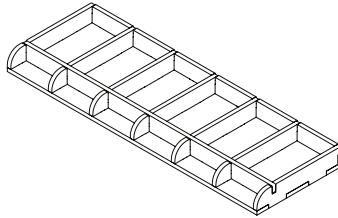

Sheet 10

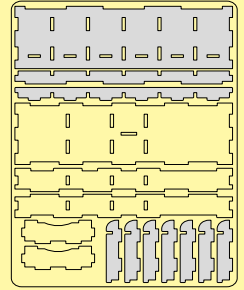

Step 1

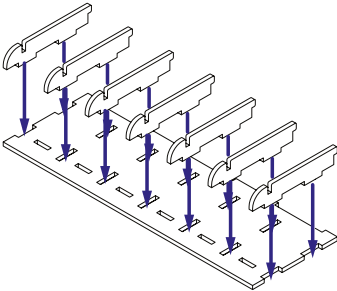

Step 2

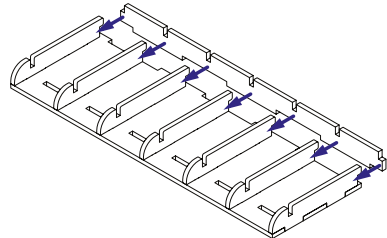

Step 3

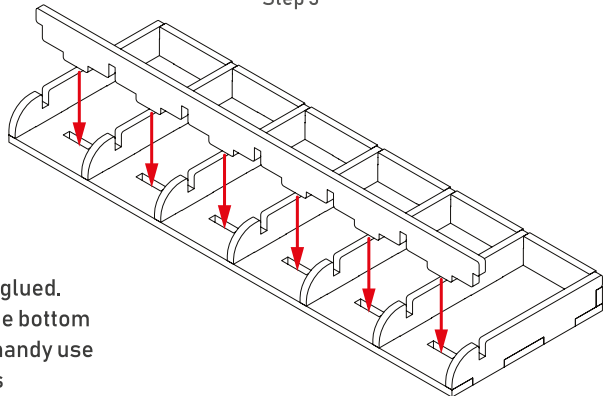

Step 3. Cover shouldn't be glued.  
Take it out and install on the bottom  
of the box before game for handy use  
of the extracted resources



# XIA Organizer XA0R01

Compatible with Xia®  
Assembly Guide

## Outfits 1

Sheet 11

Cover 3A,3B

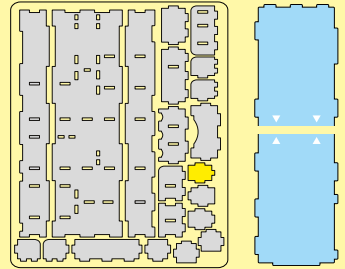
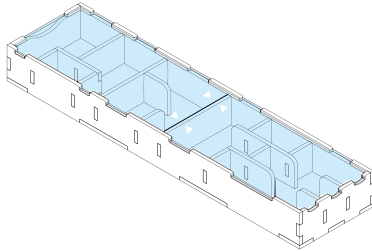

Intended for  
outfits storage

Step 1

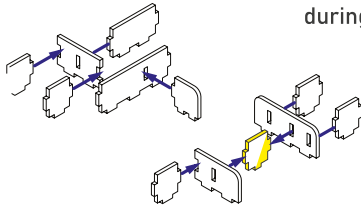

The yellow tile is different  
from the rest. Be careful  
during assembly

Step 2

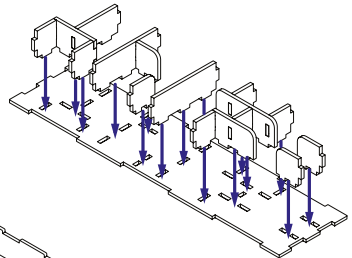

Step 4. Until the glue has completely  
dried, insert Cover 3 in the right slots.  
Do not take protective cover-up off

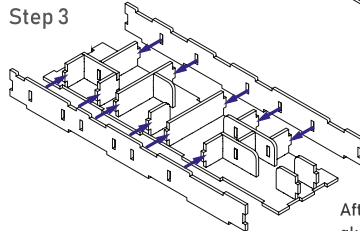

Step 4

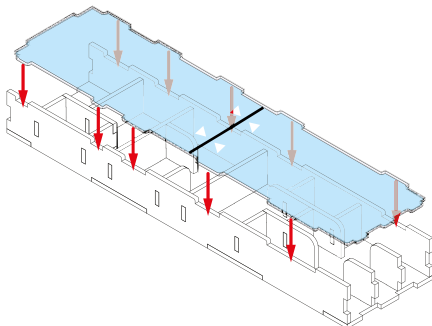

After step 5, until the  
glue has completely dried,  
make sure that Cover 3 is easily  
removed and put back in it's place.  
Only after that remove the  
protective cover-up

Step 5

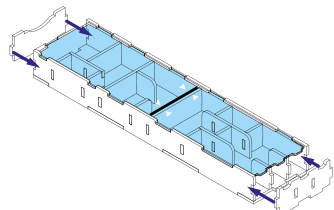



# XIA Organizer XA0R01

Compatible with Xia®  
Assembly Guide

## Outfits 2

Sheet 12

Cover 3A,3B



Intended for  
outfits storage

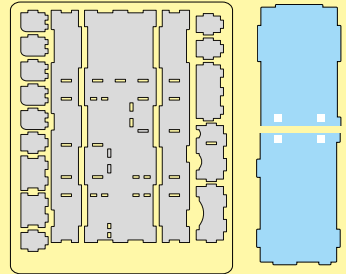
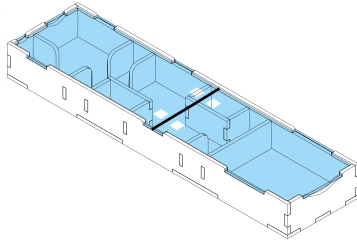

Step 1

Step 2

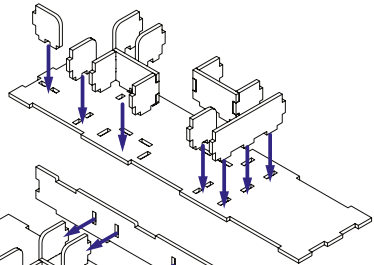
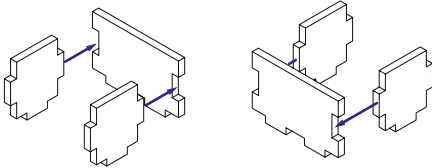

Step 3

Step 4. Until the glue has completely  
dried, insert Cover 4 in the right slots.  
Do not take protective cover-up off

Step 4

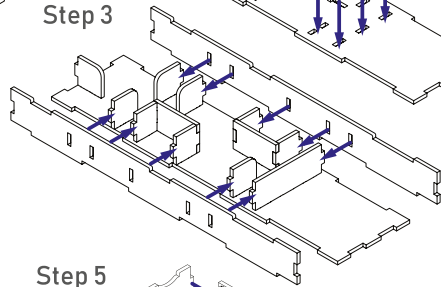

Step 5

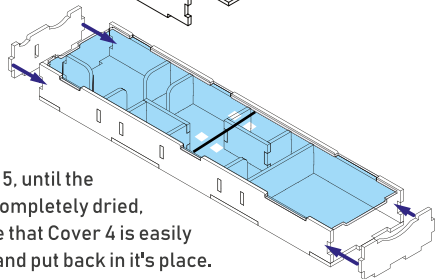
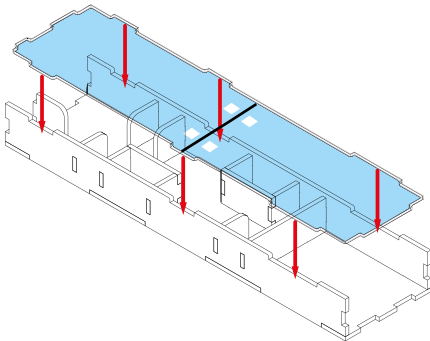

After step 5, until the  
glue has completely dried,  
make sure that Cover 4 is easily  
removed and put back in it's place.  
Only after that remove the  
protective cover-up



# XIA Organizer XA0R01

Compatible with Xia®  
Assembly Guide

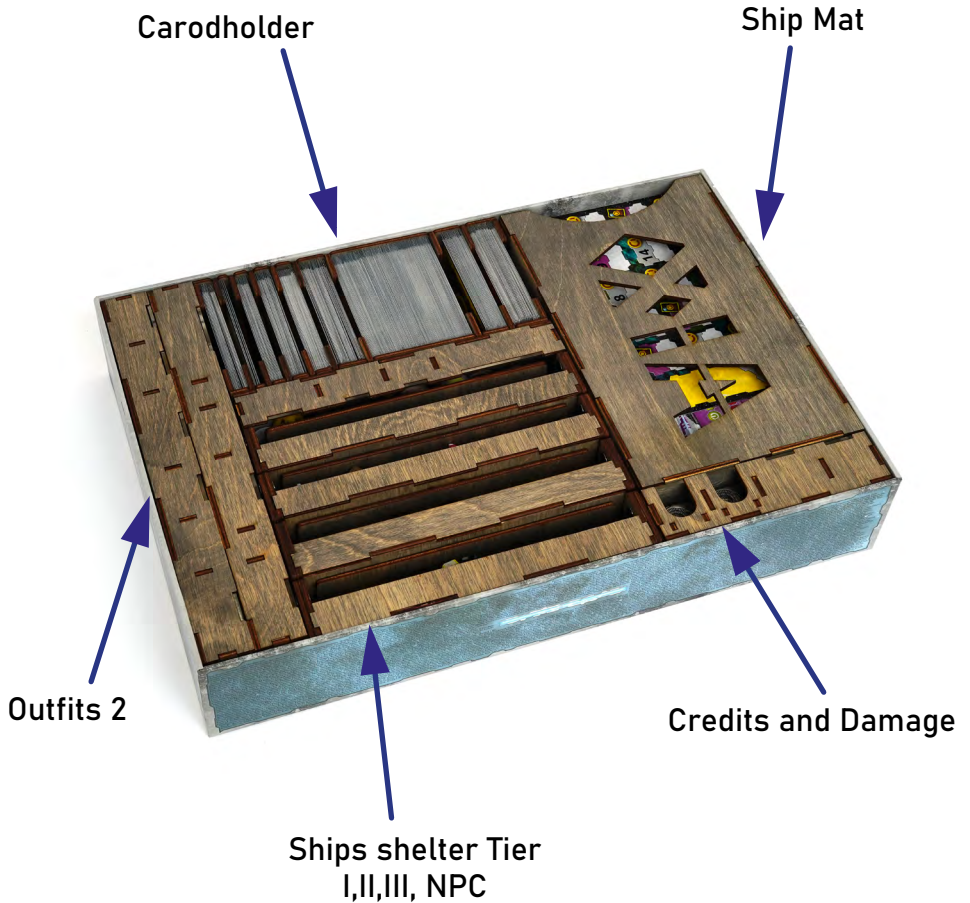



# XIA Organizer XAOR01

Compatible with Xia®  
Assembly Guide

Other smonex products:

**Terraforming Mars Organizer TMOR01**



If you have any questions about assembly,  
feel free to contact us through our site:

[smonex.com](http://smonex.com)

This is a non-licensed product. ALL RIGHTS RESERVED by their respective trademark holders. No challenge to any intellectual property rights is intended or implied by representations of compatibility and no endorsements of any of our products by any other company is implied or represented.