



ONE SMART BOX 7 Wonders® Organizer

WSOR01
Compatible with 7 Wonders®
Assembly Guide



<https://smonex.com>

Created for:

- 7 Wonders
- 7 Wonders:Leaders
- 7 Wonders:Cities
- 7 Wonders:Armada

NOT A CHILDREN TOY
AGE 14+

7 Wonders® is a registered trademark of REPOS PRODUCTION SRL. Any mention of 7 Wonders® is for reference purposes only. ALL RIGHTS RESERVED by their respective trademark holders. No challenge to any intellectual property rights is intended or implied by representations of compatibility and no endorsements of any of our products by any other company is implied or represented.



ONE SMART BOX

7 Wonders® Organizer

WSOR01
Compatible with 7 Wonders®
Assembly Guide

Tips and tricks

- To assemble each tray you need a wood glue for extra strength. (We recommend Titebond 2 Wood Glue or Beacon 527)
- Please make sure you assembled each tray correctly before gluing it together.
- Use stationery knife to cut the bits that connect details to the frame.
- Remove the details from the frame with a rotational motion along the axis formed by the bits you just cut.
- Use stationery knife and sandpaper to remove all the remaining connection bits.
- You may fix the box with rubber bands after gluing it. This will save you time and simplify the assembly.
- Use a hairdryer for easier removal of the protective covering from acrylic details. Just heat the acrylic surface a little to remove the covering much easier!
- Leave your finished insert overnight to dry completely.

Assembly Supplies



Wood-glue



Stationery knife



Hammer



Cotton swab



Rubber bands



Hairdryer

If something is damaged or broken, please do not return the whole set. Contact us directly on email info@smonex.com or our website smonex.com. Any questions or issues with the Smonex products, we'll do our best to help you. We want our customers to be completely satisfied.

IMPORTANT: Assemble each tray one by one. Please DO NOT take out all the parts from the sheets and mix them. Even though some parts look similar, they are not interchangeable.



ONE SMART BOX 7 Wonders® Organizer

WSOR01
Compatible with 7 Wonders®
Assembly Guide

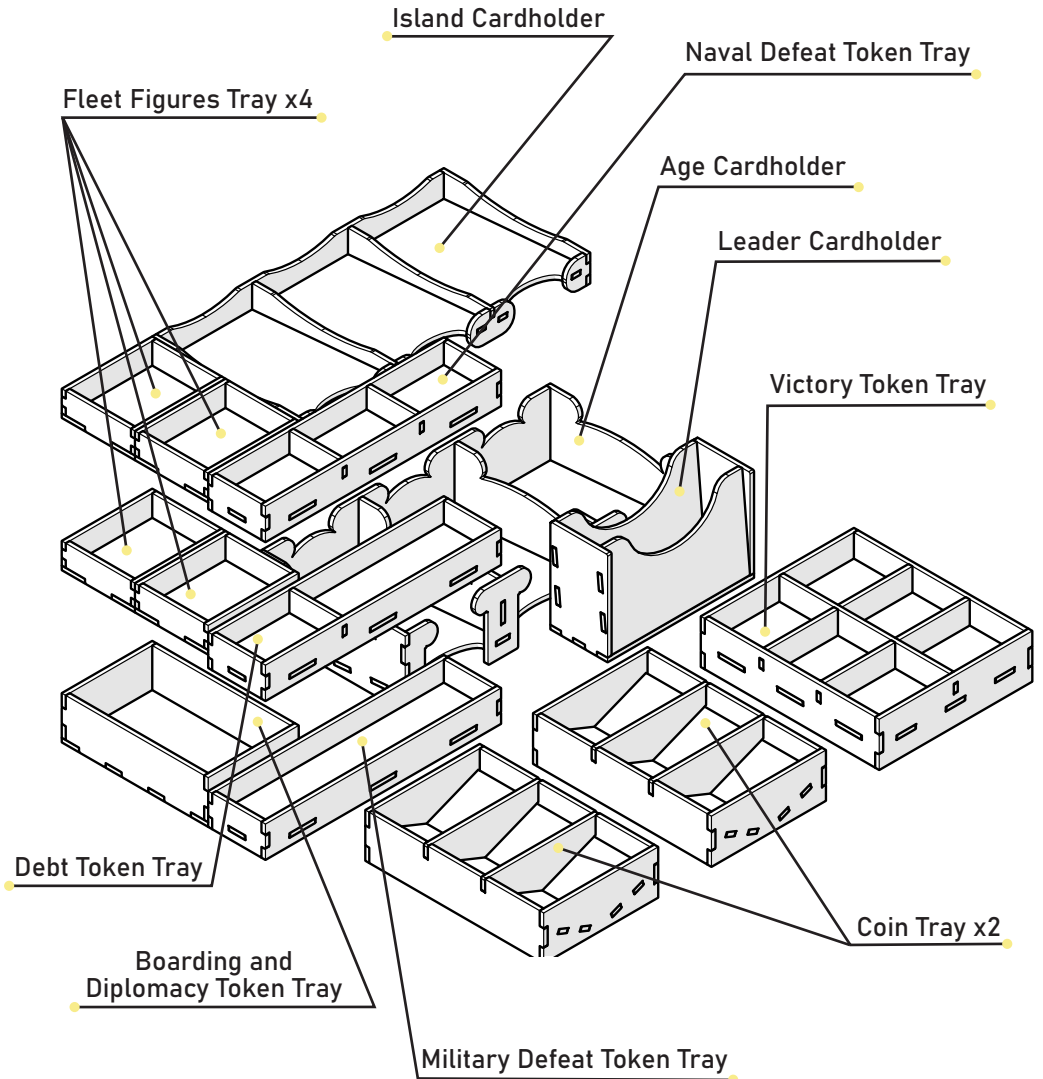



ONE SMART BOX

7 Wonders® Organizer

WSOR01
Compatible with 7 Wonders®
Assembly Guide

- Brief assembly instructions:**
1. Unpack and arrange the sheets in order.
 2. Compare details on the sheets with details in the pictures of the guide.
 3. Study the pictures of unassembled product.
 4. Start your assembly, taking the necessary parts out of the sheets in a certain order.

Sheet 1

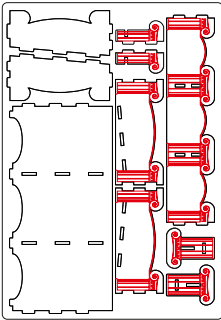

Sheet 2

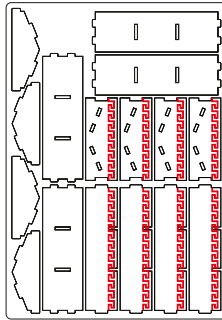

Sheet 3

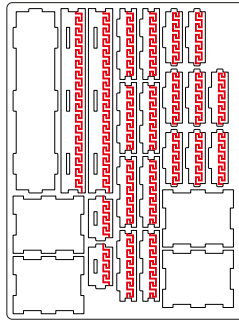

Sheet 4

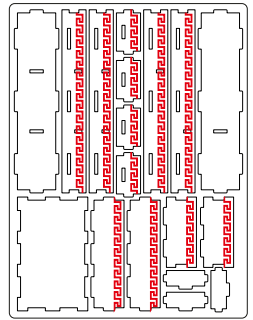

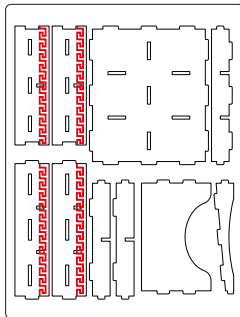

Sheet 5

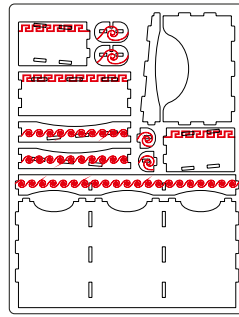

Sheet 6



Legend:

-  Highlighted details to be extruded
-  Details not used in this assembly
-  Details to be glued

Components:

- 6 sheets extrusion molds
- 1 sandpaper for stripping parts
- Assembly guide



ONE SMART BOX 7 Wonders® Organizer

WSOR01
Compatible with 7 Wonders®
Assembly Guide

Age Cardholder

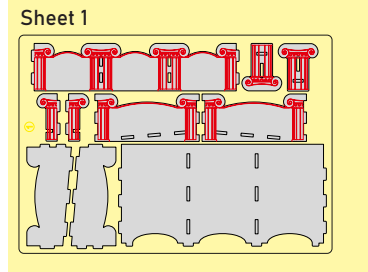
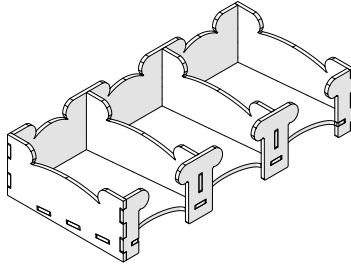

Step 1

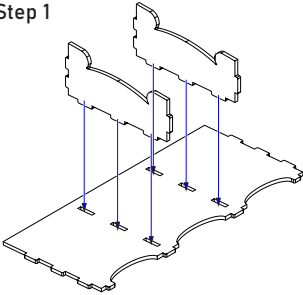

Step 2

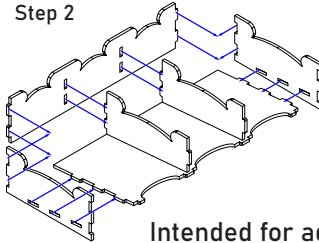

Step 3

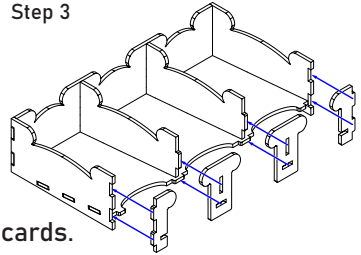

Intended for age cards.

Coin trays x2

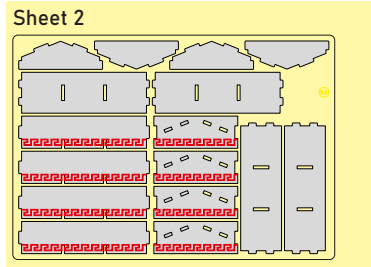
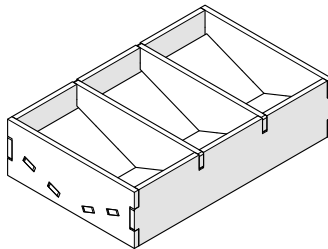

Step 1

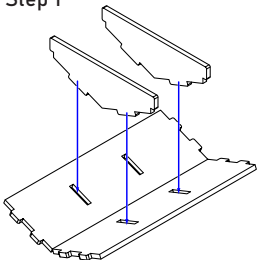

Step 2

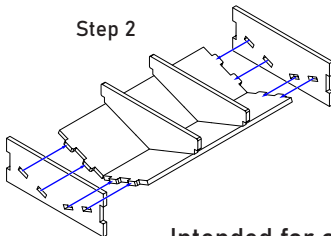

Step 3

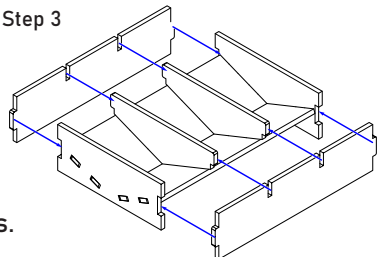

Intended for coins.



ONE SMART BOX 7 Wonders® Organizer

WSOR01
Compatible with 7 Wonders®
Assembly Guide

Fleet Figures Tray x4

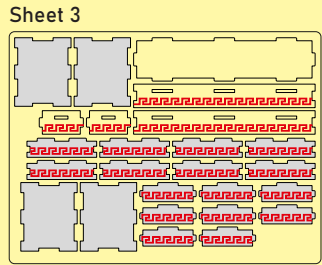
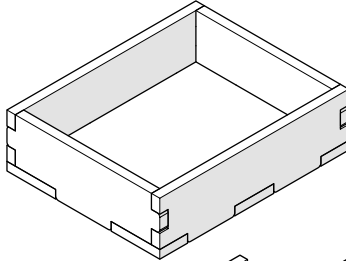

Step 1

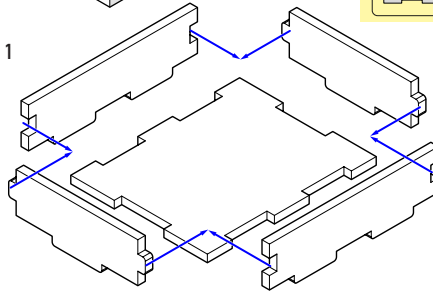

Intended for Fleet Figures.

Military Defeat Token Tray

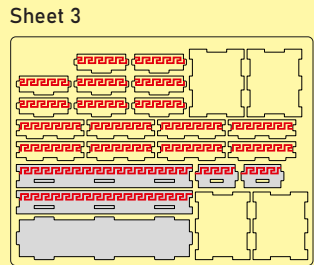
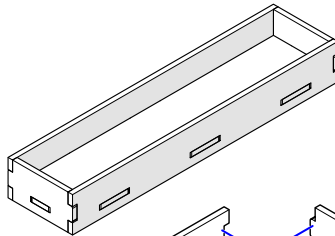

Step 1

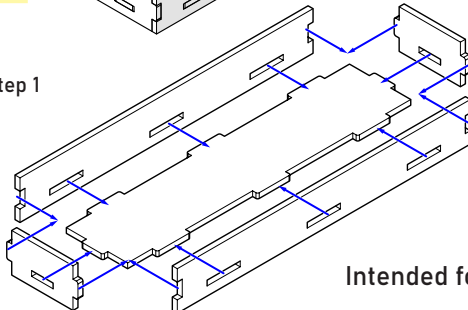

Intended for Military Defeat Tokens.



ONE SMART BOX 7 Wonders® Organizer

WSOR01
Compatible with 7 Wonders®
Assembly Guide

Naval Defeat Token Tray

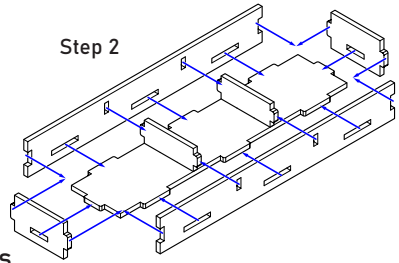
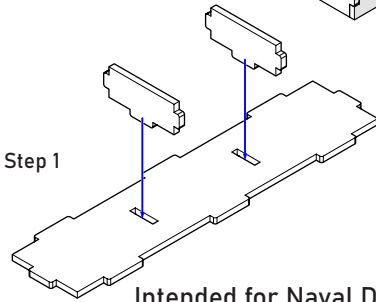
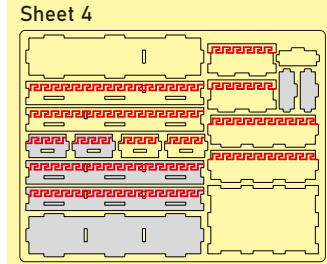
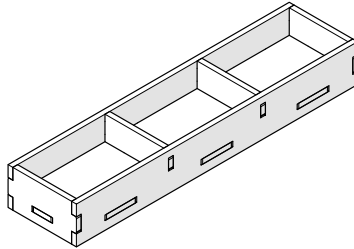

Debt Token Tray

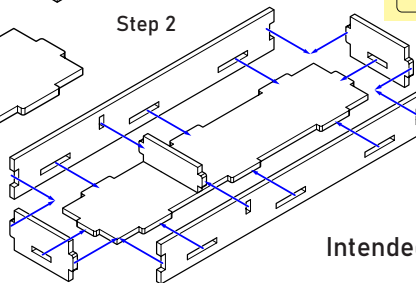
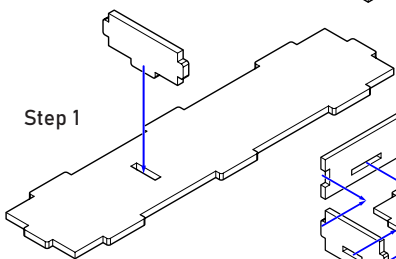
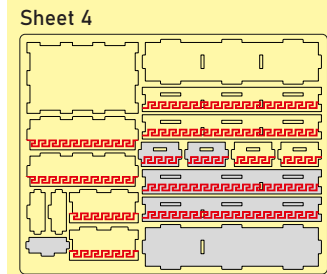
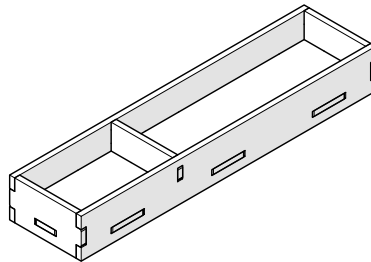

Intended for Debt Tokens.



ONE SMART BOX 7 Wonders® Organizer

WSOR01
Compatible with 7 Wonders®
Assembly Guide

Boarding and Diplomacy Token Tray



Step 1

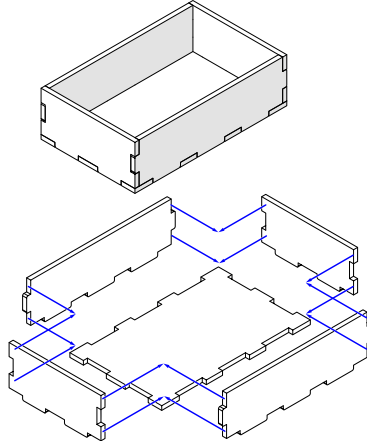

Sheet 4

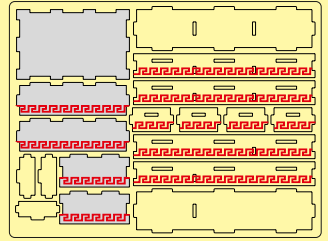

Intended for Boarding and Diplomacy Tokens.

Victory Token Tray



Step 1

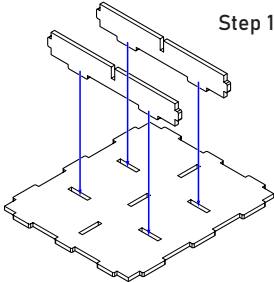

Step 2

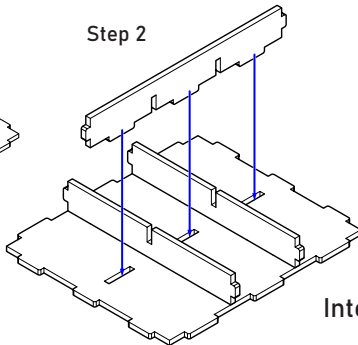

Step 3

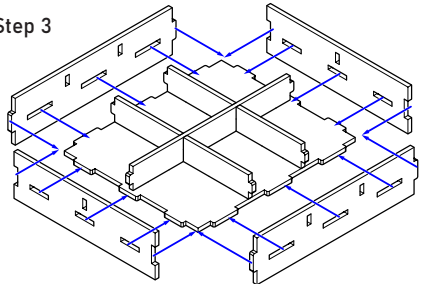

Intended for Victory Tokens.

Sheet 5

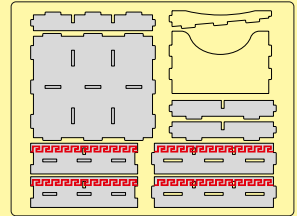



ONE SMART BOX 7 Wonders® Organizer

WSOR01
Compatible with 7 Wonders®
Assembly Guide

Leader Cardholder

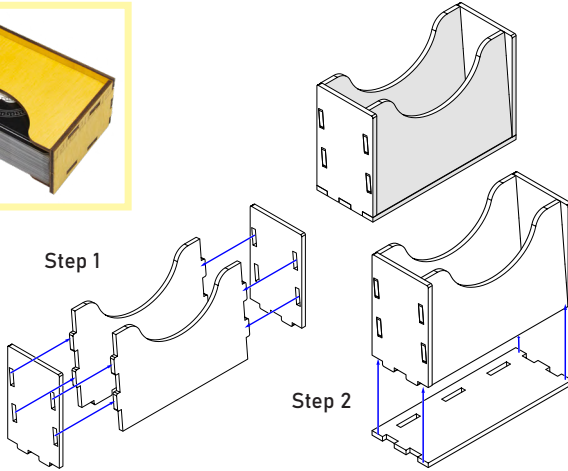

Sheets 5, 6

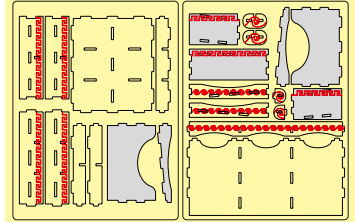

Intended for Leader cards.

Island Cardholder

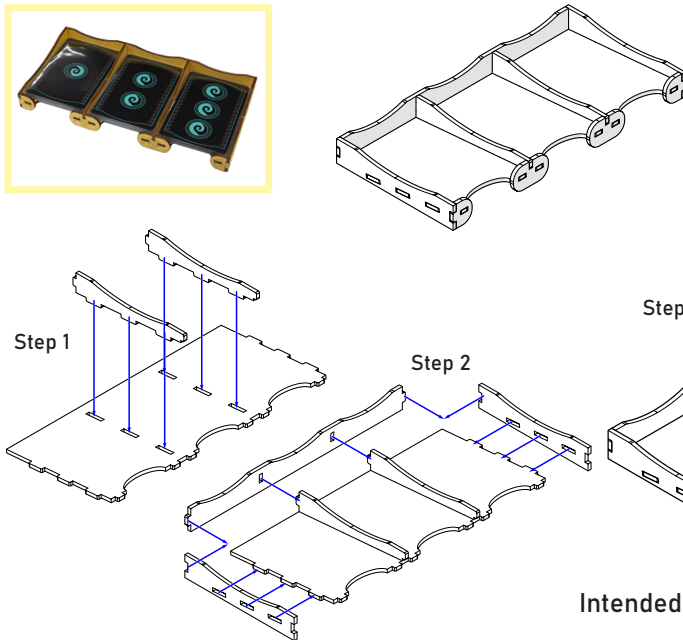
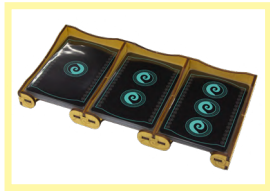

Sheet 6

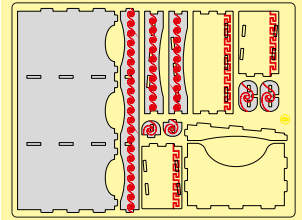

Intended for Island cards.



ONE SMART BOX 7 Wonders® Organizer

WSOR01
Compatible with 7 Wonders®
Assembly Guide

If something is damaged or broken, please do not return the whole set. Contact us directly on email info@smonex.com or our website smonex.com.

Any questions or issues with the Smonex products, we'll do our best to help you. Your satisfaction of it is our top priority.

Welcome to <https://smonex.com>.

Thanks for choosing Smonex product. We would be grateful for your feedback, which inspires us and helps to develop further. We'll gladly help you on any matter if you contact us on info@smonex.com.

Share your photos with #smonex and follow us for all the updates:

 <https://www.facebook.com/Smonexcom>

 https://www.instagram.com/smonex_com/

 https://twitter.com/Smonex_com

 https://www.pinterest.com/smonex/_shop/

 <https://www.youtube.com/c/SmonexSmartOneBox>



Scan QR-code to visit or follow Smonex.



ONE SMART BOX

Some other SMONEX products:

Terraforming Mars Organizer TMOR01



Betrayal Organizer BLOR01





ONE SMART BOX

Some other SMONEX products:

Gloomhaven Organizer GNOR01



Scythe Organizer SEOR01

