



ONE SMART BOX

# Unfathomable® Organizer

UEOR01

Compatible with Unfathomable® board game

Assembly Guide



<https://smonex.com>

Created for:

- Unfathomable board game

NOT A CHILDREN TOY

**AGE 14+**

Unfathomable® is a registered trademark of Fantasy Flight Games. Any mention of Unfathomable® is for reference purposes only. ALL RIGHTS RESERVED by their respective trademark holders. No challenge to any intellectual property rights is intended or implied by representations of compatibility and no endorsements of any of our products by any other company is implied or represented.



ONE SMART BOX

# Unfathomable® Organizer

## UEOR01

Compatible with Unfathomable® board game  
Assembly Guide

### Tips and tricks

- To assemble each tray you need a wood glue for extra strength. (We recommend Titebond 2 Wood Glue or Beacon 527).
- Please make sure you assembled each tray correctly before gluing it together.
- Use stationery knife to cut the bits that connect details to the frame.
- Remove the details from the frame with a rotational motion along the axis formed by the bits you just cut.
- Use stationery knife and sandpaper to remove all the remaining connection bits.
- Please note that the engraving must be on the outside of the boxes.
- You may fix the box with rubber bands after gluing it. This will save you time and simplify the assembly.
- Make sure to remove the protective covering from BOTH sides of the acrylic pieces. Use a hairdryer for easier removal of it if necessary. Just heat the acrylic surface a little to remove the covering much easier!
- Leave your finished insert overnight to dry completely.

### Assembly Supplies



Wood-glue



Stationery knife



Hammer



Cotton swab



Rubber bands



Hairdryer

If something is damaged or broken, please do not return the whole set. Contact us directly on email [info@smonex.com](mailto:info@smonex.com) or our website [smonex.com](http://smonex.com). Any questions or issues with the Smonex products, we'll do our best to help you. We want our customers to be completely satisfied.

**IMPORTANT:** Assemble each tray one by one. Please DO NOT take out all the parts from the sheets and mix them. Even though some parts look similar, they are not interchangeable.



ONE SMART BOX

# Unfathomable® Organizer

UEOR01

Compatible with Unfathomable® board game

## Assembly Guide

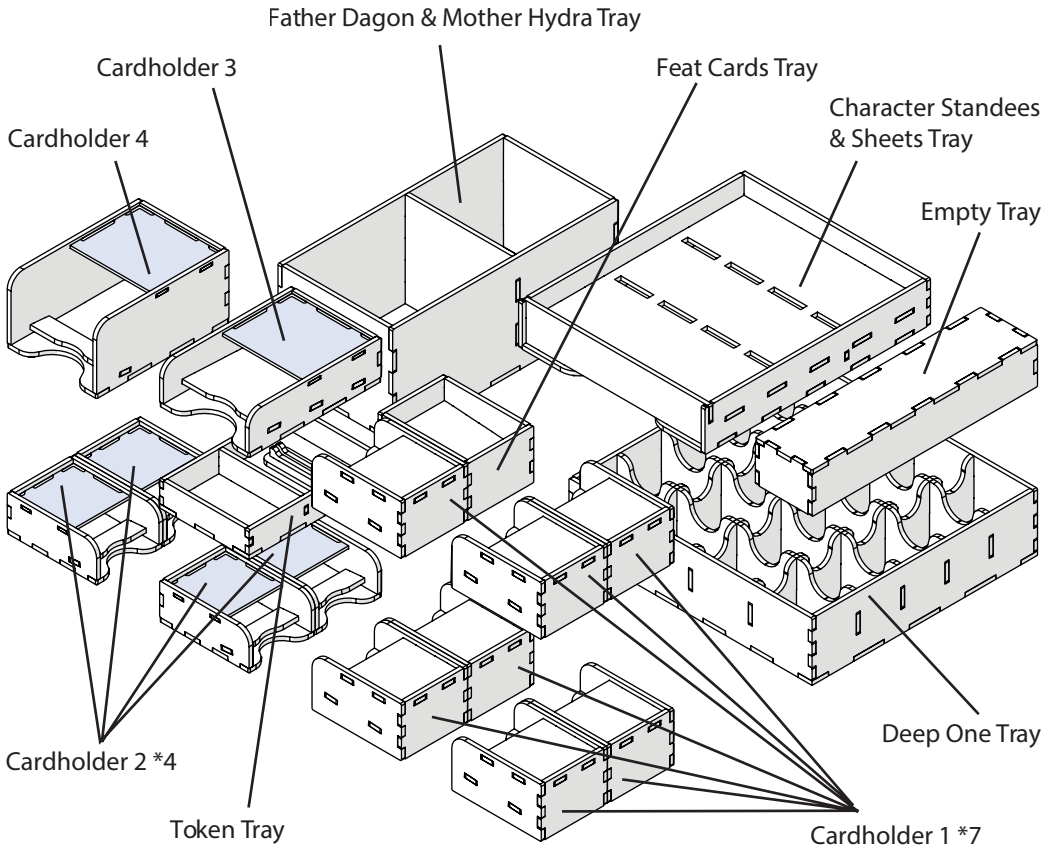



ONE SMART BOX

# Unfathomable® Organizer

UEOR01

Compatible with Unfathomable® board game

## Assembly Guide

### Brief assembly instructions:

1. Unpack and arrange the sheets in order.
2. Compare details on the sheets with details in the pictures of the guide.
3. Study the pictures of unassembled product.
4. Start your assembly, taking the necessary parts out of the sheets in a certain order.

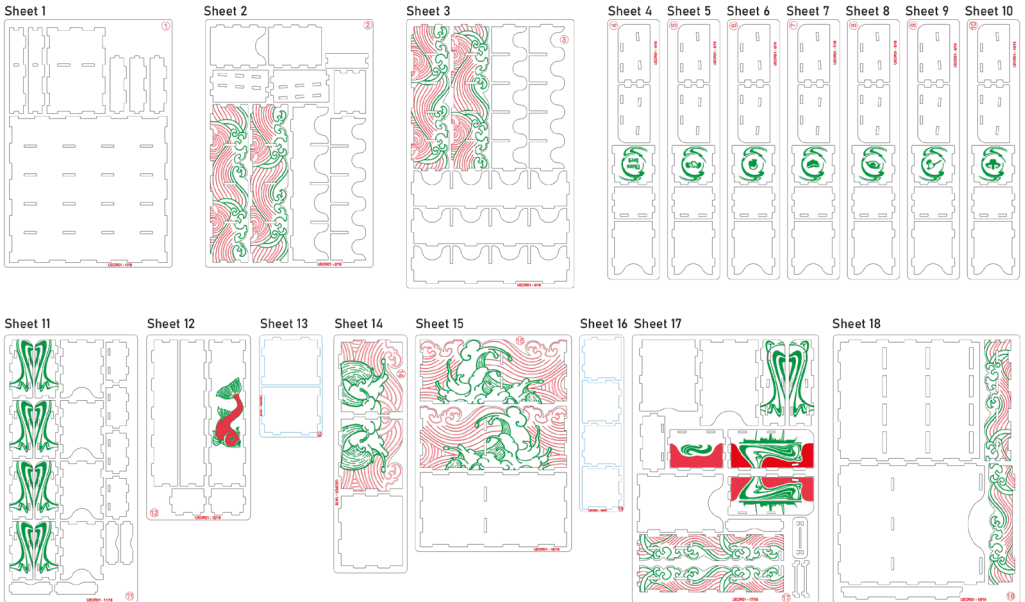

### Legend:

- Details to be extruded
- Details not used in this assembly
- Details to be glued
- Details to be connected without glue

### Components:

- 16 sheets extrusion molds
- 2 acrylic extrusion molds
- 1 sandpaper for stripping parts
- Assembly guide



ONE SMART BOX

# Unfathomable® Organizer

UEOR01

Compatible with Unfathomable® board game

## Assembly Guide

### Token Tray

Intended for Die, Passenger and Current Player tokens.

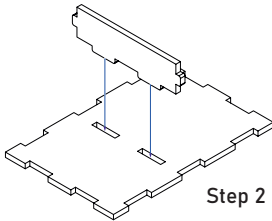
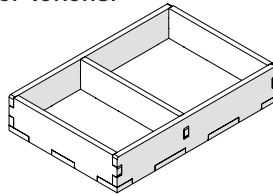

Step 1

Step 2

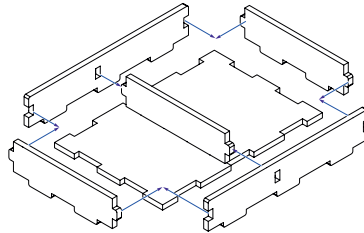

Sheet 1

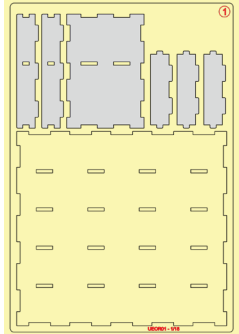

### Feat Cards Tray

Intended for Feat cards and Traitor rings.

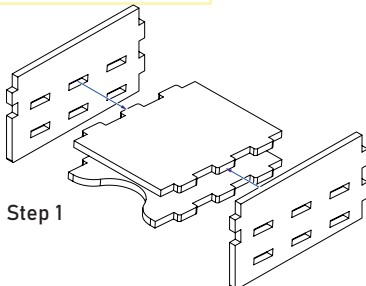
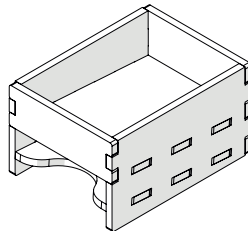

Step 1

Step 2

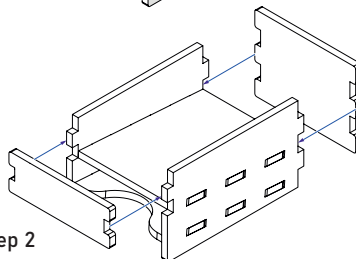

Sheet 2

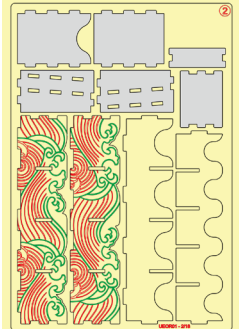



ONE SMART BOX

# Unfathomable® Organizer

UEOR01

Compatible with Unfathomable® board game

## Assembly Guide

### Deep One Tray

Intended for Deep One figures.

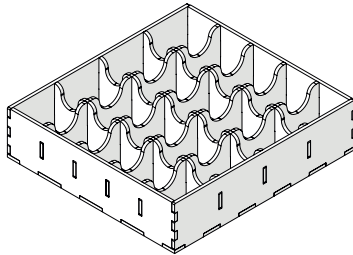

Sheets 1, 2, 3

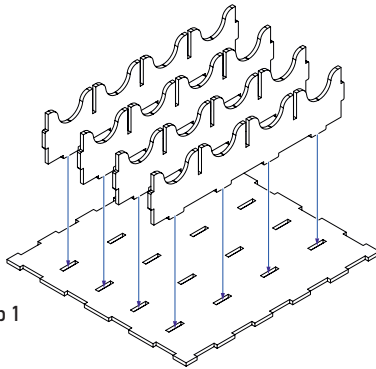
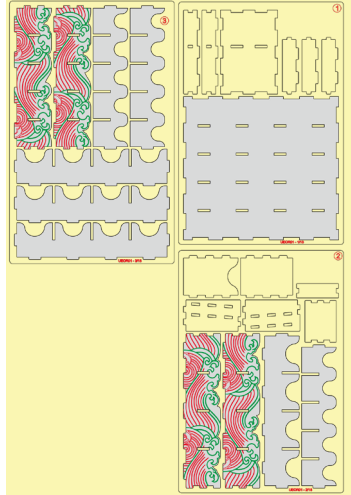

Step 1

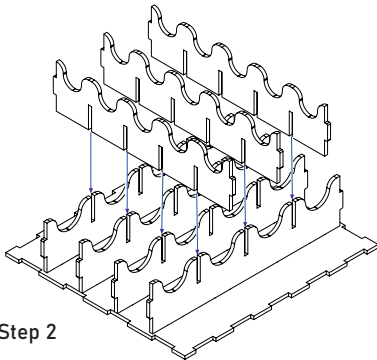

Step 2

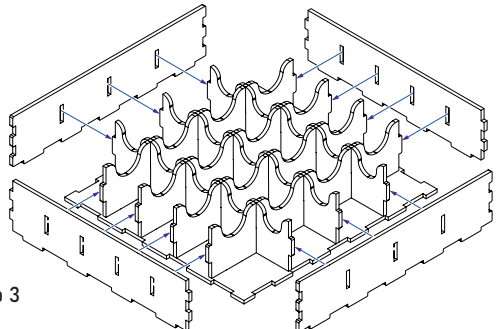

Step 3



ONE SMART BOX

# Unfathomable® Organizer

UEOR01

Compatible with Unfathomable® board game

## Assembly Guide

### Cardholder 1 \*7



Intended for Skill cards and Chaos deck.

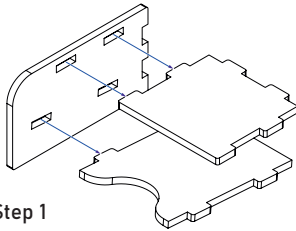
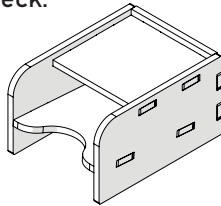

Step 1

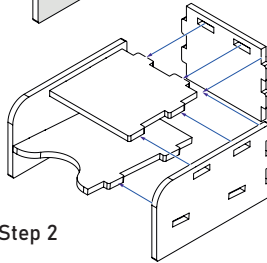

Step 2

Sheets 4, 5, 6, 7, 8, 9, 10

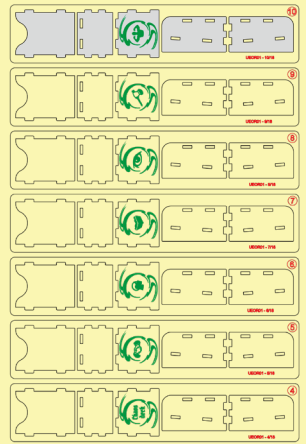

### Cardholder 2 \*4



Intended for Waypoint, Spell, Item and Ship Damage cards.

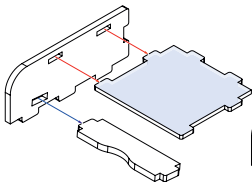
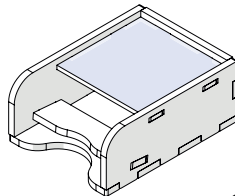

Step 1

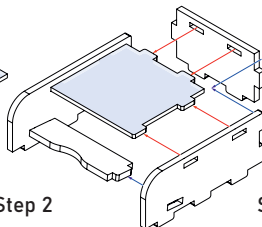

Step 2

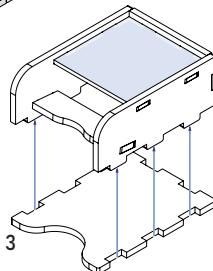

Step 3

Sheets 11, 16

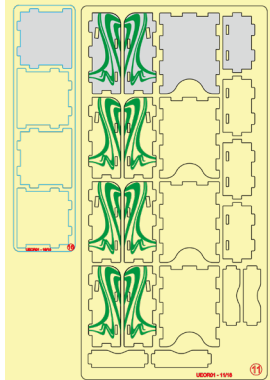

First of all, remove the protective covering from BOTH sides of the acrylic piece. Assemble the tray only after taking off the coverings.





ONE SMART BOX

# Unfathomable® Organizer

UEOR01

Compatible with Unfathomable® board game

## Assembly Guide

### Empty Tray



Intended for filling the space in the box.

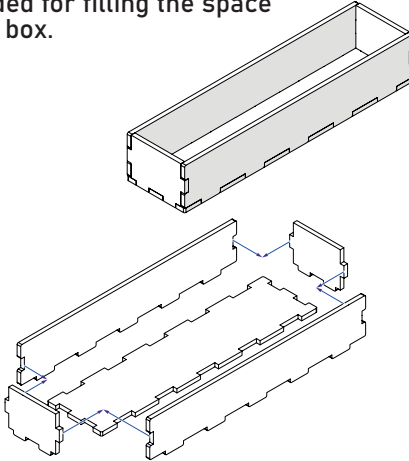

Step 1

Sheet 12

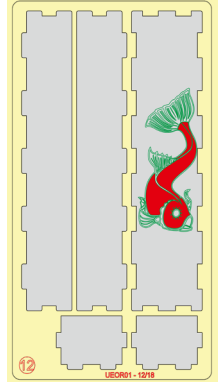

### Father Dagon & Mother Hydra Tray



Intended for Father Dagon and Mother Hydra miniatures.

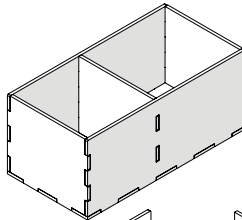

Step 1

Step 2

Sheets 14, 15

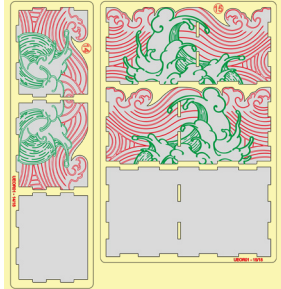





ONE SMART BOX

# Unfathomable® Organizer UEOR01

Compatible with Unfathomable® board game

## Assembly Guide

### Cardholder 3



Intended for Loyalty cards.

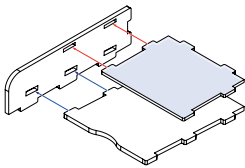
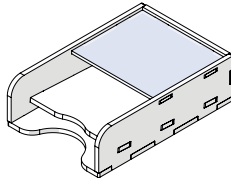

Step 1

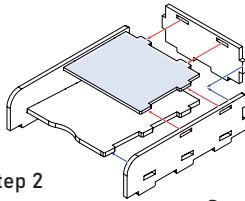

Step 2

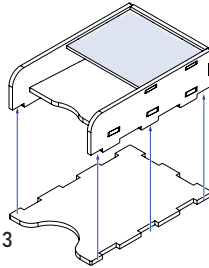

Step 3

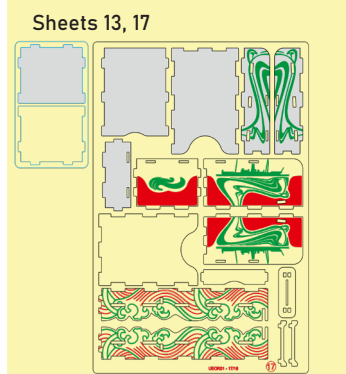

Sheets 13, 17

First of all, remove the protective covering from BOTH sides of the acrylic piece. Assemble the tray only after taking off the coverings.

### Cardholder 4



Intended for Mythos cards.

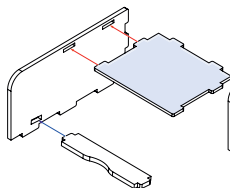
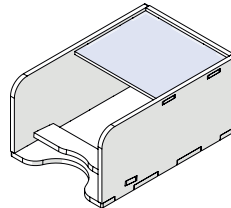

Step 1

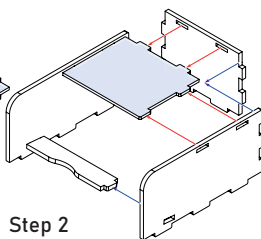

Step 2

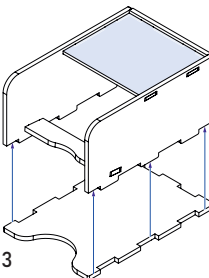

Step 3

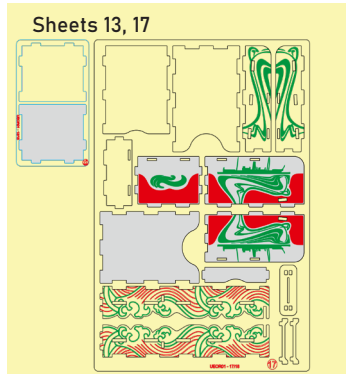

Sheets 13, 17

First of all, remove the protective covering from BOTH sides of the acrylic piece. Assemble the tray only after taking off the coverings.



ONE SMART BOX

# Unfathomable® Organizer UEOR01

Compatible with Unfathomable® board game  
Assembly Guide

## Character Standees & Sheets Tray



Intended for Character standees & sheets.

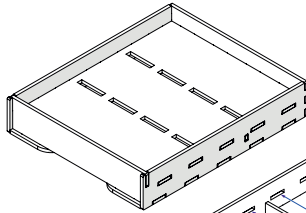

Sheets 17, 18

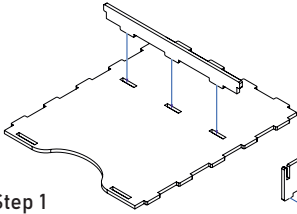
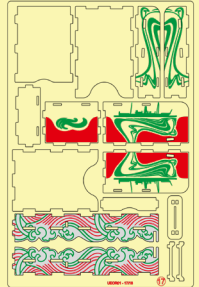

Step 1

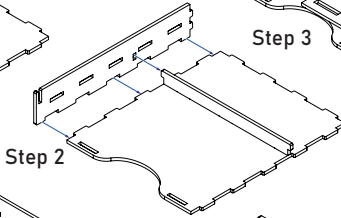

Step 2

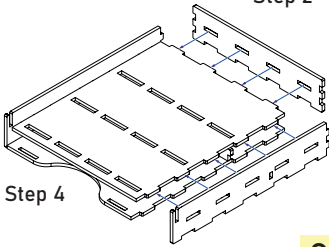

Step 4

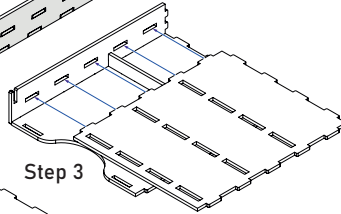

Step 3

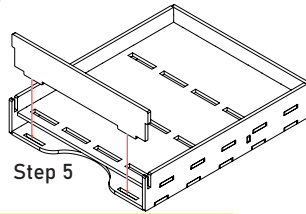

Step 5

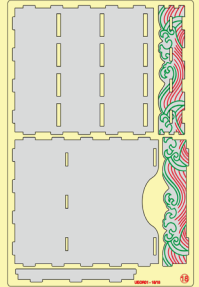

## Current Player Token Holder

Intended for Current Player token.

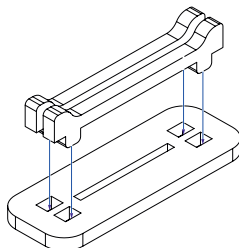

Step 1

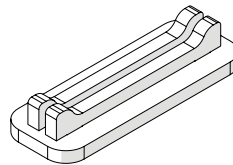

Sheet 17

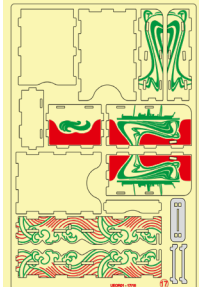



## ONE SMART BOX

Some other SMONEX products:

Underwater Cities ® Organizer UWCOR01



Dune ® Organizer DEOR01





ONE SMART BOX





Welcome to <https://smonex.com>.

If something is damaged or broken, please do not return the whole set. Contact us directly on email [info@smonex.com](mailto:info@smonex.com) or our website [smonex.com](https://smonex.com).

Any questions or issues with the Smonex products, we'll do our best to help you. Your satisfaction of it is our top priority.

Thanks for choosing Smonex product. We would be grateful for your feedback, which inspires us and helps to develop further. We'll gladly help you on any matter if you contact us on [info@smonex.com](mailto:info@smonex.com).

Share your photos with **#smonex** and follow us for all the updates:

-  <https://www.facebook.com/Smonexcom>
-  [https://www.instagram.com/smonex\\_com/](https://www.instagram.com/smonex_com/)
-  [https://twitter.com/Smonex\\_com](https://twitter.com/Smonex_com)
-  [https://www.pinterest.com/smonex/\\_shop/](https://www.pinterest.com/smonex/_shop/)
-  <https://www.youtube.com/c/SmonexSmartOneBox>



Scan QR-code to visit or follow Smonex.