



ONE SMART BOX Splendor® Organizer

SR0R01

Compatible with Splendor® board game with All Expansions
Assembly Guide



<https://smonex.com>

Created for:

- Splendor
with All Expansions

NOT A CHILDREN TOY
AGE 14+

Splendor® is a registered trademark of Space Cowboys. Any mention of Splendor® is for reference purposes only. ALL RIGHTS RESERVED by their respective trademark holders. No challenge to any intellectual property rights is intended or implied by representations of compatibility and no endorsements of any of our products by any other company is implied or represented.



ONE SMART BOX

Splendor® Organizer

SROR01
Compatible with Splendor® board game with All Expansions
Assembly Guide

Tips and tricks

- To assemble each tray you need a wood glue for extra strength. (We recommend Titebond 2 Wood Glue or Beacon 527).
- Please make sure you assembled each tray correctly before gluing it together.
- Use stationery knife to cut the bits that connect details to the frame.
- Remove the details from the frame with a rotational motion along the axis formed by the bits you just cut.
- Use stationery knife and sandpaper to remove all the remaining connection bits.
- Please note that the engraving must be on the outside of the boxes.
- You may fix the box with rubber bands after gluing it. This will save you time and simplify the assembly.
- Make sure to remove the protective covering from BOTH sides of the acrylic pieces. Use a hairdryer for easier removal of it if necessary. Just heat the acrylic surface a little to remove the covering much easier!
- Leave your finished insert overnight to dry completely.

Assembly Supplies



Wood-glue



Stationery knife



Hammer



Cotton swab



Rubber bands



Hairdryer

If something is damaged or broken, please do not return the whole set. Contact us directly on email info@smonex.com or our website smonex.com. Any questions or issues with the Smonex products, we'll do our best to help you. We want our customers to be completely satisfied.

IMPORTANT: Assemble each tray one by one. Please DO NOT take out all the parts from the sheets and mix them. Even though some parts look similar, they are not interchangeable.



ONE SMART BOX Splendor® Organizer

SROR01

Compatible with Splendor® board game with All Expansions
Assembly Guide

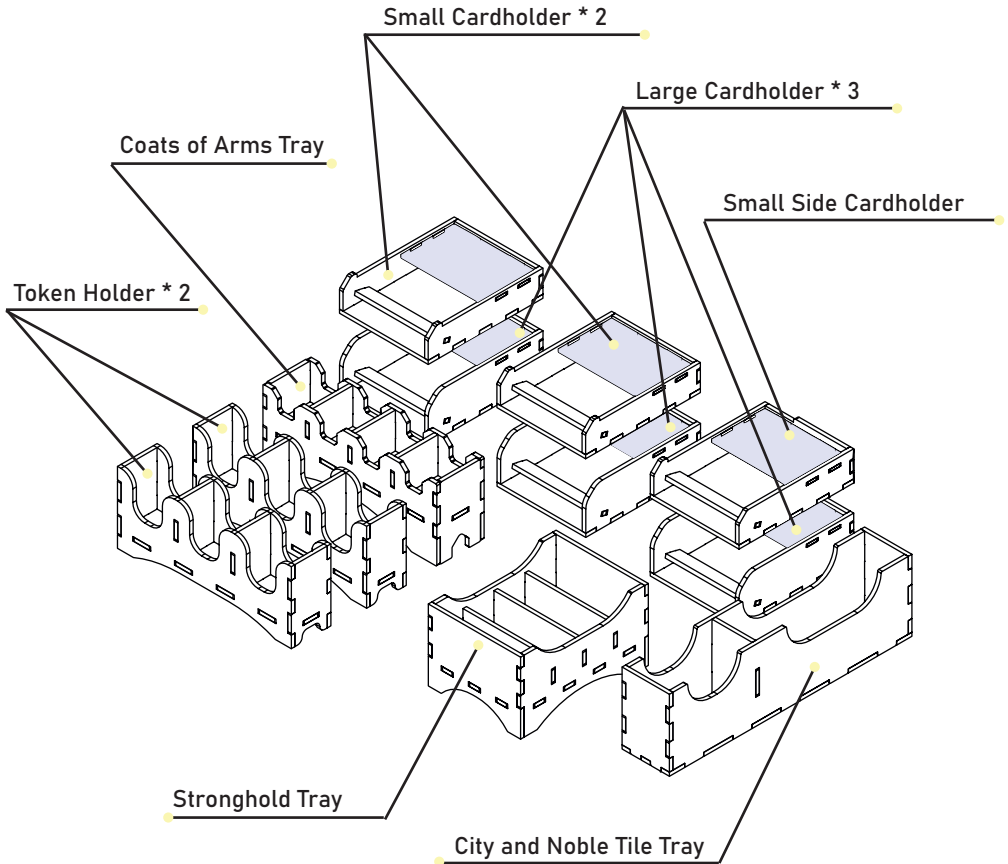



ONE SMART BOX Splendor® Organizer



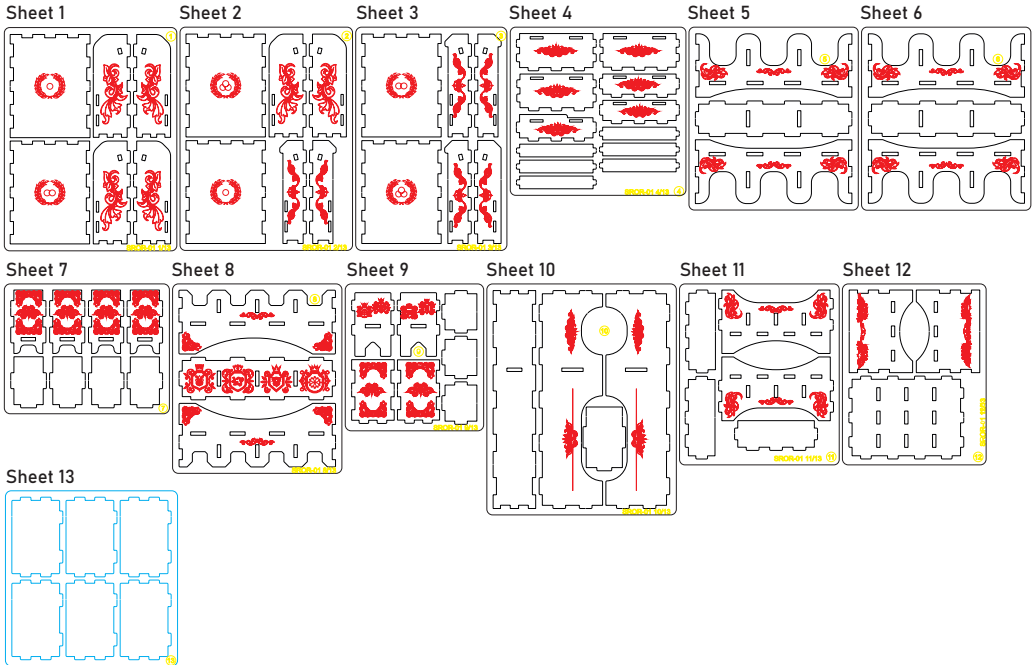

SROR01

Compatible with Splendor® board game with All Expansions
Assembly Guide

- Brief assembly instructions:**
1. Unpack and arrange the sheets in order.
 2. Compare details on the sheets with details in the pictures of the guide.
 3. Study the pictures of unassembled product.
 4. Start your assembly, taking the necessary parts out of the sheets in a certain order.



Legend:

-  Highlighted details to be extruded
-  Details not used in this assembly
-  Details to be glued
-  Details to be connected without glue

Components:

- 12 sheets extrusion molds
- 1 acrylic sheet extrusion mold
- 1 sandpaper for stripping parts
- Assembly guide



ONE SMART BOX Splendor® Organizer

SROR01
Compatible with Splendor® board game with All Expansions
Assembly Guide

Large Cardholder * 3



Make sure to remove the protective covering from BOTH sides of the acrylic pieces BEFORE starting assembly.

Intended for Development Cards.

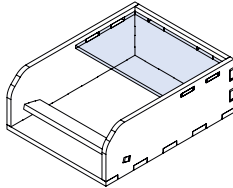

Sheets 1, 2, 4, 13

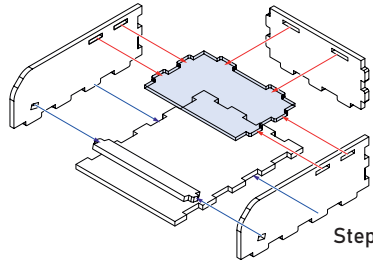
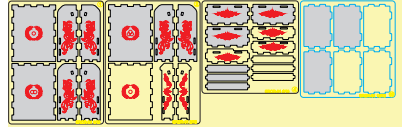

Step 1

Small Cardholder * 2



Make sure to remove the protective covering from BOTH sides of the acrylic pieces BEFORE starting assembly.

Intended for Development Cards.

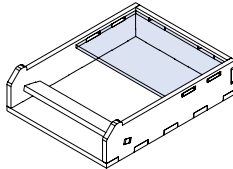

Sheets 2, 3, 4, 13

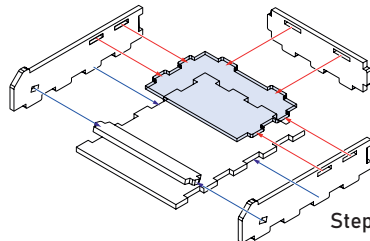
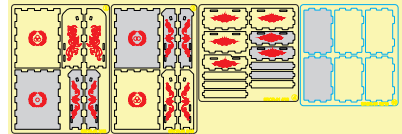

Step 1



ONE SMART BOX Splendor® Organizer

SROR01
Compatible with Splendor® board game with All Expansions
Assembly Guide

Small Side Cardholder



Intended for Development
Cards.

Sheets 3, 4, 13

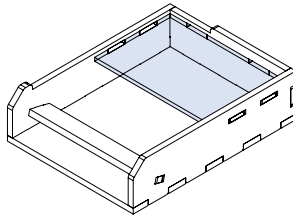
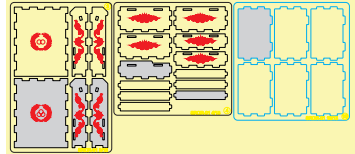

Make sure to remove the protective covering from BOTH sides of the acrylic pieces BEFORE starting the assembly.

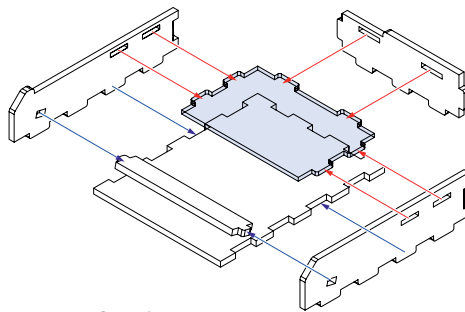

Step 1



ONE SMART BOX Splendor® Organizer

SR0R01
Compatible with Splendor® board game with All Expansions
Assembly Guide

Token Holder * 2



Intended for tokens.

Sheets 5, 6, 7

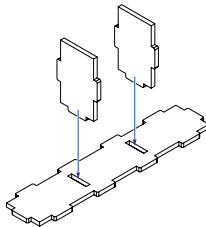
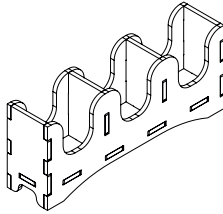
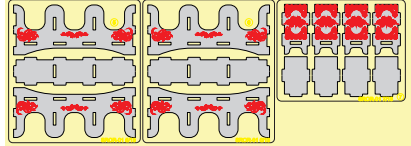

Step 1

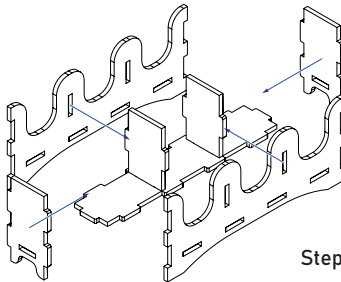

Step 2



ONE SMART BOX Splendor® Organizer

SROR01
Compatible with Splendor® board game with All Expansions
Assembly Guide

Coats of Arms Tray

Intended for Coats of Arms.

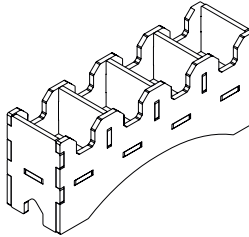

Sheets 8, 9

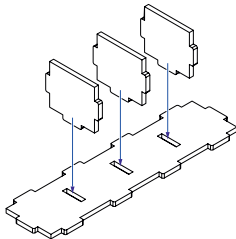
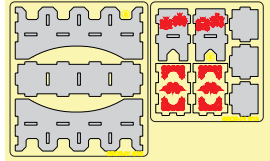

Step 1

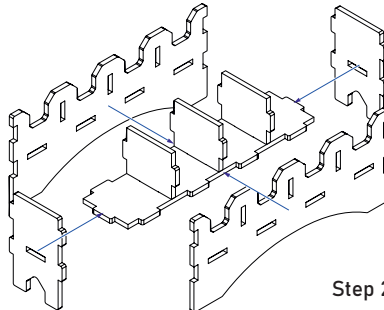

Step 2



ONE SMART BOX Splendor® Organizer

SROR01

Compatible with Splendor® board game with All Expansions
Assembly Guide

City and Noble Tile Tray

Intended for City and Noble Tiles.

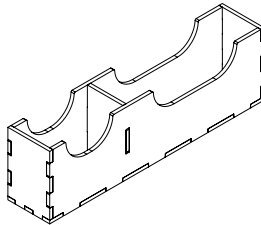

Sheets 9, 10

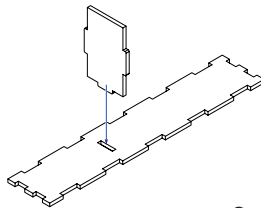
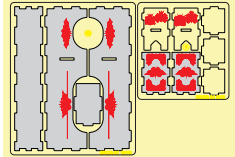

Step 1

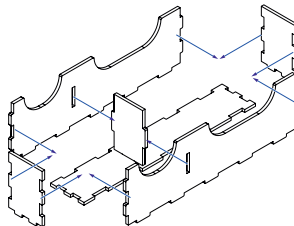

Step 2



ONE SMART BOX Splendor® Organizer

SR0R01
Compatible with Splendor® board game with All Expansions
Assembly Guide

Stronghold Tray

Intended for Strongholds.

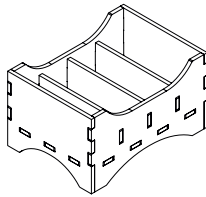

Sheets 11, 12

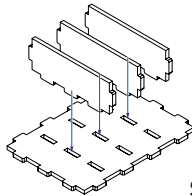
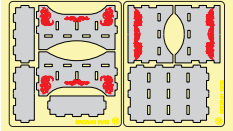

Step 1

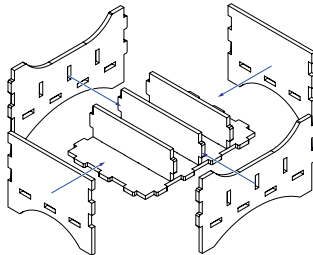

Step 2



ONE SMART BOX

Some other SMONEX products:
Twilight Struggle[®] Organizer TSOR01



Lords of Waterdeep[®] Organizer LWDOR01





ONE SMART BOX

Welcome to <https://smonex.com>.

If something is damaged or broken, please do not return the whole set. Contact us directly on email info@smonex.com or our website smonex.com.

Any questions or issues with the Smonex products, we'll do our best to help you. Your satisfaction of it is our top priority.

Thanks for choosing Smonex product. We would be grateful for your feedback, which inspires us and helps to develop further. We'll gladly help you on any matter if you contact us on info@smonex.com.

Share your photos with #smonex and follow us for all the updates:

 <https://www.facebook.com/Smonexcom>

 https://www.instagram.com/smonex_com/

 https://twitter.com/Smonex_com

 https://www.pinterest.com/smonex/_shop/

 <https://www.youtube.com/c/SmonexSmartOneBox>



Scan QR-code to visit or follow Smonex.