



# ONE SMART BOX Spirit Island® Organizer

SIOR01

Compatible with Spirit Island® board game with All Expansions  
Assembly Guide



<https://smonex.com>

Created for:

- Spirit Island  
with All Expansions

NOT A CHILDREN TOY  
**AGE 14+**

Spirit Island® is a registered trademark of Greater Than Games. Any mention of Spirit Island® is for reference purposes only. ALL RIGHTS RESERVED by their respective trademark holders. No challenge to any intellectual property rights is intended or implied by representations of compatibility and no endorsements of any of our products by any other company is implied or represented.



ONE SMART BOX

# Spirit Island® Organizer

SIOR01

Compatible with Spirit Island® board game with All Expansions  
Assembly Guide

## Tips and tricks

- To assemble each tray you need a wood glue for extra strength. (We recommend Titebond 2 Wood Glue or Beacon 527).
- Please make sure you assembled each tray correctly before gluing it together.
- Use stationery knife to cut the bits that connect details to the frame.
- Remove the details from the frame with a rotational motion along the axis formed by the bits you just cut.
- Use stationery knife and sandpaper to remove all the remaining connection bits.
- You may fix the box with rubber bands after gluing it. This will save you time and simplify the assembly.
- Make sure to remove the protective covering from BOTH sides of the acrylic pieces. Use a hairdryer for easier removal of it if necessary. Just heat the acrylic surface a little to remove the covering much easier!
- Leave your finished insert overnight to dry completely.

## Assembly Supplies



Wood-glue



Stationery knife



Hammer



Cotton swab



Rubber bands



Hairdryer

If something is damaged or broken, please do not return the whole set. Contact us directly on email [info@smonex.com](mailto:info@smonex.com) or our website [smonex.com](http://smonex.com). Any questions or issues with the Smonex products, we'll do our best to help you. We want our customers to be completely satisfied.

**IMPORTANT:** Assemble each tray one by one. Please DO NOT take out all the parts from the sheets and mix them. Even though some parts look similar, they are not interchangeable.



# ONE SMART BOX Spirit Island® Organizer

SIOR01

Compatible with Spirit Island® board game with All Expansions  
Assembly Guide

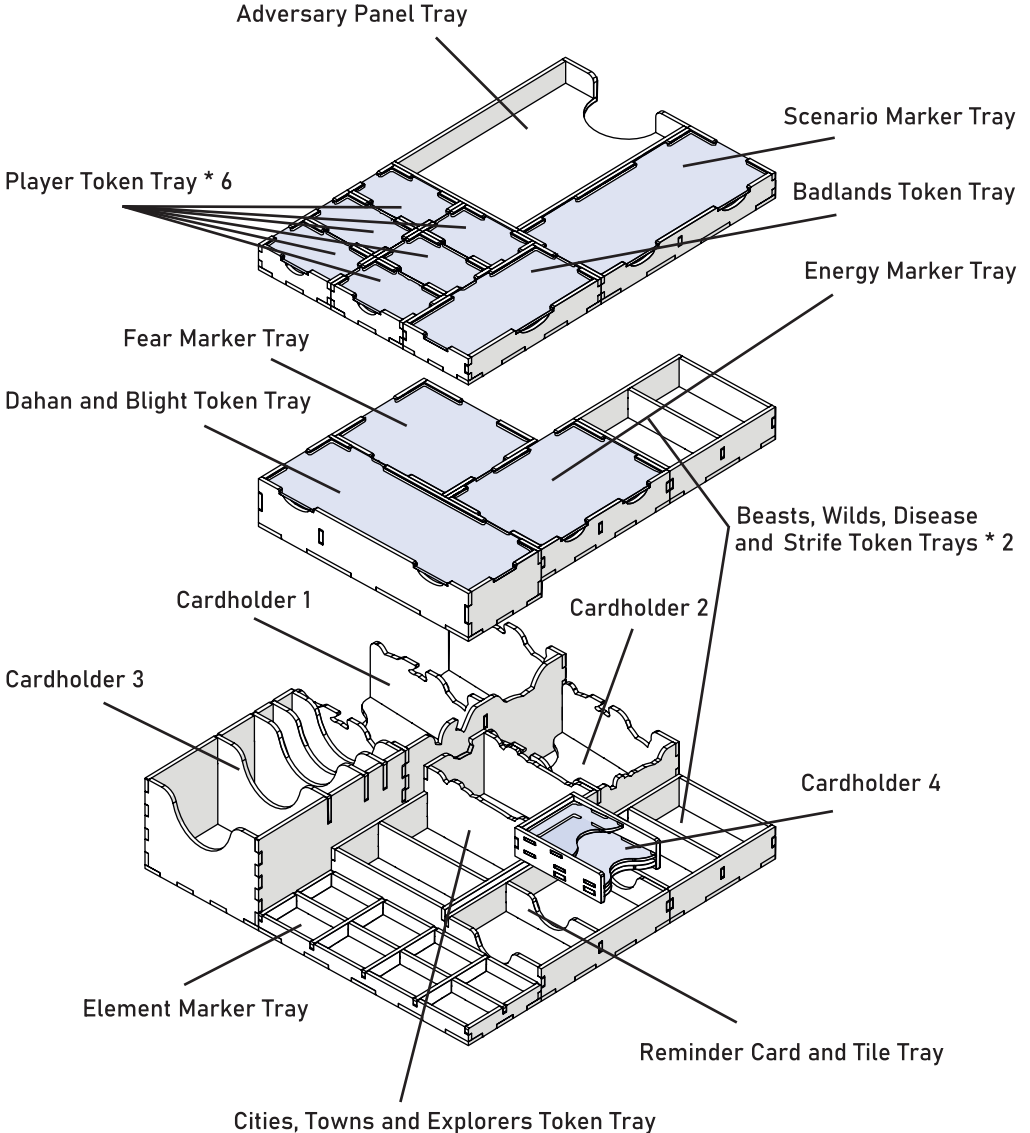



# ONE SMART BOX Spirit Island® Organizer



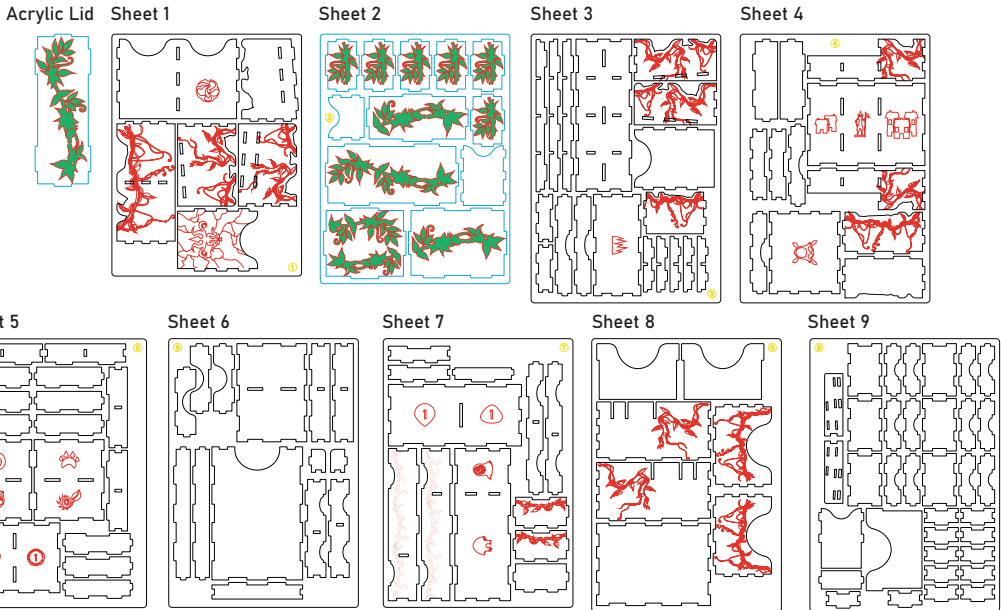

SIOR01

Compatible with Spirit Island® board game with All Expansions  
Assembly Guide

- Brief assembly instructions:**
1. Unpack and arrange the sheets in order.
  2. Compare details on the sheets with details in the pictures of the guide.
  3. Study the pictures of unassembled product.
  4. Start your assembly, taking the necessary parts out of the sheets in a certain order.



### Legend:

-  Highlighted details to be extruded
-  Details not used in this assembly
-  Details to be glued
-  Details to be connected without glue

### Components:

- 8 sheets extrusion molds
- 1 acrylic sheet extrusion mold
- 1 acrylic lid
- 1 sandpaper for stripping parts
- Assembly guide



# ONE SMART BOX Spirit Island® Organizer

SIOR01  
Compatible with Spirit Island® board game with All Expansions  
Assembly Guide

## Cardholder 1

Intended for Power Cards.



Please note that the engraving must be on the outside of the boxes.

Sheet 1

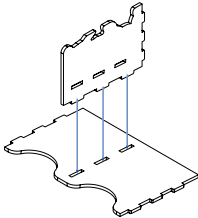
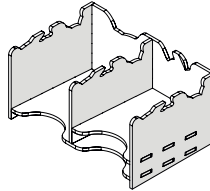
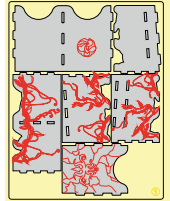

Step 1

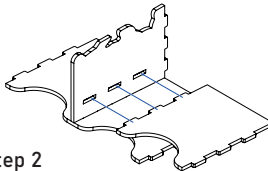

Step 2

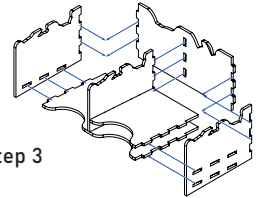

Step 3

## Badlands Token Tray

Intended for Badlands Tokens.



Sheets 2, 3

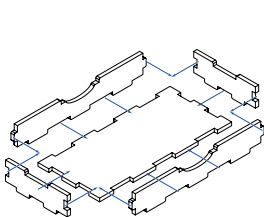
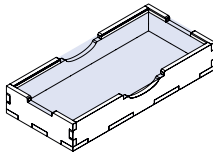
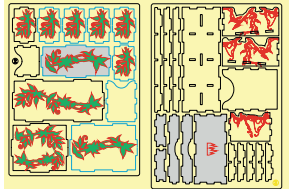

Step 1

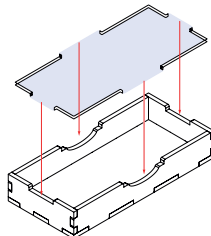

Step 2

Until the glue has completely dried, make sure the lid fits the tray and can be easily removed. Put it back in its place on the tray. Only then carefully remove the protective covering.



## ONE SMART BOX

# Spirit Island® Organizer

SIOR01

Compatible with Spirit Island® board game with All Expansions  
Assembly Guide

### Element Marker Tray

Intended for Element Markers.

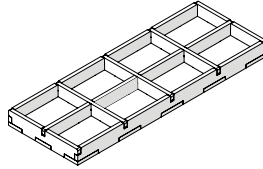

Sheet 3

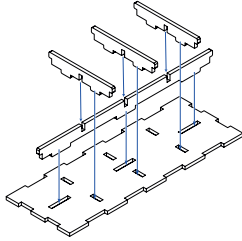
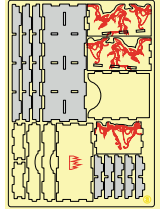

Step 1

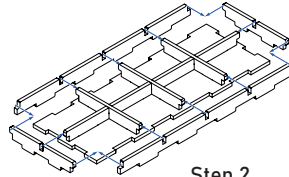

Step 2

### Cardholder 2

Intended for Event Cards.

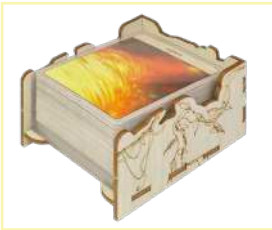

Please note that the engraving must be on the outside of the boxes.

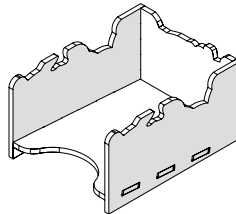

Sheet 3

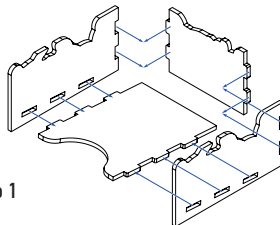
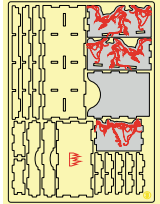

Step 1



# ONE SMART BOX

## Spirit Island® Organizer

SIOR01  
Compatible with Spirit Island® board game with All Expansions  
Assembly Guide

### Cities, Towns and Explorers Token Tray.



Intended for Cities, Towns and Explorers Tokens.

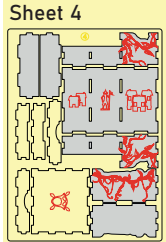

Please note that the engraving must be on the outside of the boxes.

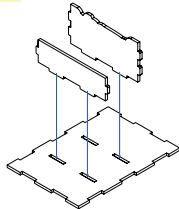

Step 1

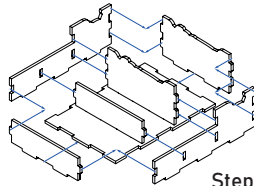
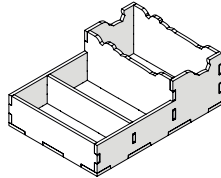

Step 2

### Fear Marker Tray

Intended for Item Markers.



Sheets 2, 4

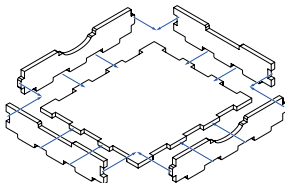
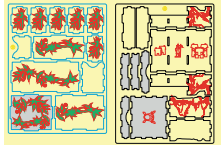

Step 1

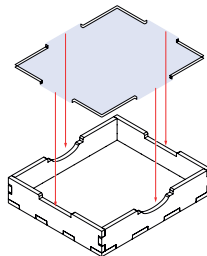

Step 2

Until the glue has completely dried, make sure the lid fits the tray and can be easily removed. Put it back in its place on the tray. Only then carefully remove the protective covering.



# ONE SMART BOX Spirit Island® Organizer

SIOR01  
Compatible with Spirit Island® board game with All Expansions  
Assembly Guide

## Beasts, Wilds, Disease and Strife Token Trays



Intended for Beasts, Wilds, Disease and Strife Tokens. Follow the engravings.

Sheet 5

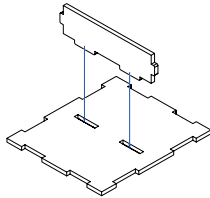
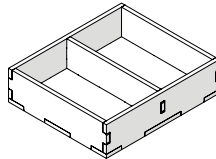
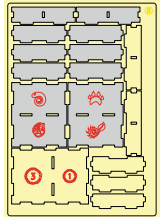

Step 1

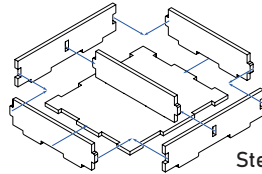

Step 2

## Energy Marker Tray

Intended for Energy Markers. Follow the engravings.

Sheets 2, 5, 6

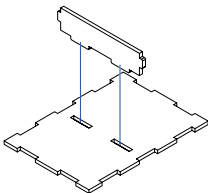
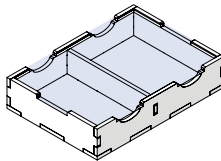
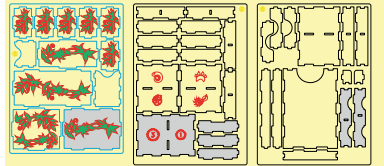

Step 1

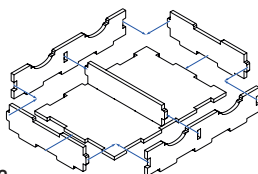

Step 2

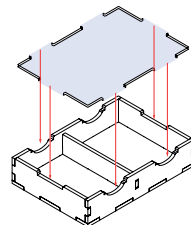

Step 3

Until the glue has completely dried, make sure the lid fits the tray and can be easily removed. Put it back in its place on the tray. Only then carefully remove the protective covering.





# ONE SMART BOX Spirit Island® Organizer

SIOR01  
Compatible with Spirit Island® board game with All Expansions  
Assembly Guide

## Adversary Panel Tray

Intended for Adversary Panels.

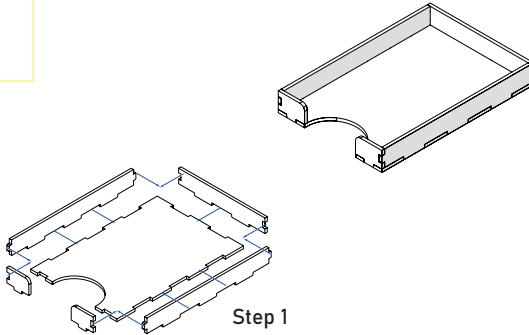

Sheet 6

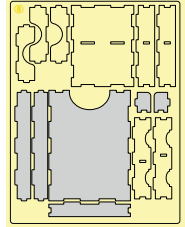

## Reminder Cards and Tiles Tray

Intended for Reminder Cards  
and Tiles.

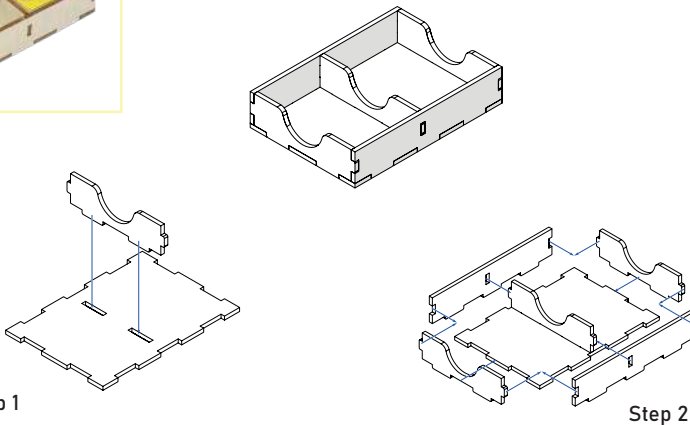

Sheet 6

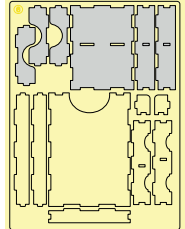



# ONE SMART BOX Spirit Island® Organizer

SIOR01  
Compatible with Spirit Island® board game with All Expansions  
Assembly Guide

## Scenario Marker Tray

Intended for Scenario Markers.

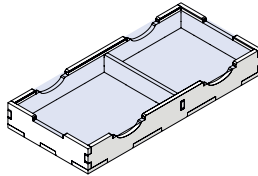

Sheets 2, 7

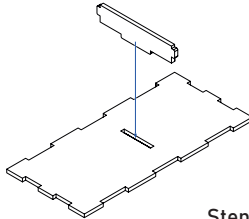
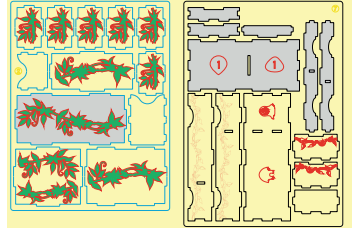

Step 1

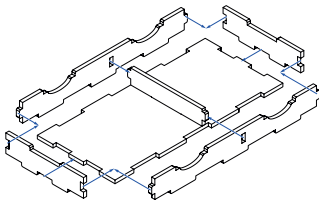

Step 2

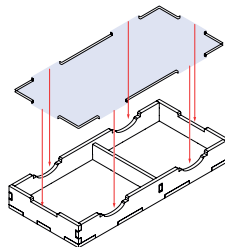

Step 3

Until the glue has completely dried, make sure the lid fits the tray and can be easily removed. Put it back in its place on the tray. Only then carefully remove the protective covering.



# ONE SMART BOX Spirit Island® Organizer

SIOR01  
Compatible with Spirit Island® board game with All Expansions  
Assembly Guide

## Dahan and Blight Token Tray



Intended for Dahan and Blight Tokens. Follow the engravings.

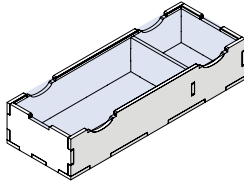

Please note that the engraving must be on the outside of the boxes.

## Sheet 7, Acrylic Lid

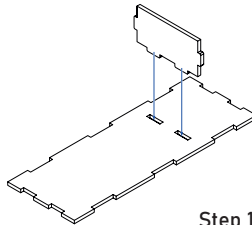
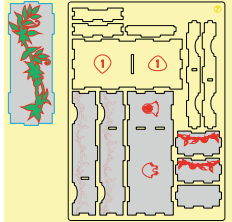

Step 1

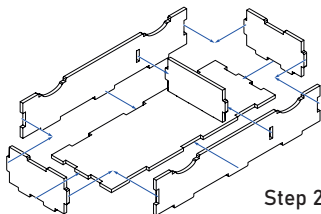

Step 2

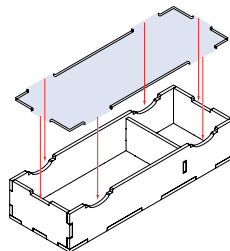

Step 3

Until the glue has completely dried, make sure the lid fits the tray and can be easily removed. Put it back in its place on the tray. Only then carefully remove the protective covering.



# ONE SMART BOX Spirit Island® Organizer

SIOR01  
Compatible with Spirit Island® board game with All Expansions  
Assembly Guide

## Cardholder 3

Intended for Player Aid, Fear, Blight and Aspect Cards.

Sheets 8, 9

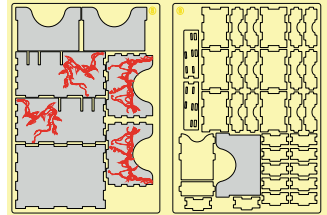
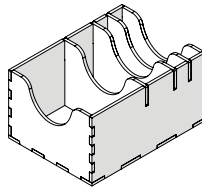

Please note that the engraving must be on the outside of the boxes.

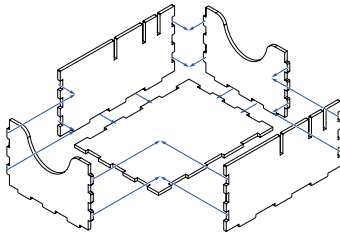

Step 1

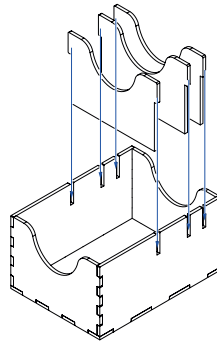

Step 2



# ONE SMART BOX Spirit Island® Organizer

SIOR01  
Compatible with Spirit Island® board game with All Expansions  
Assembly Guide

## Player Token Tray \* 6

Intended for Effect Markers.

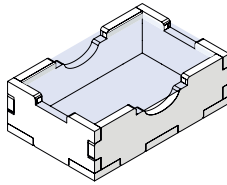

Sheets 2, 9

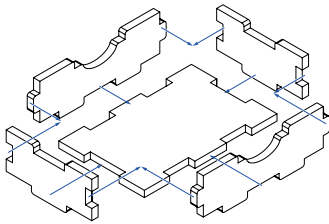
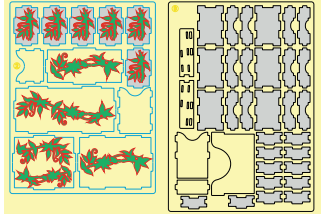

Step 1

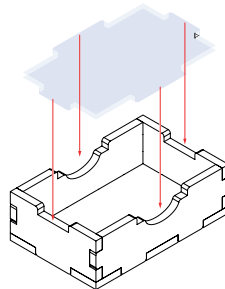

Step 2

Until the glue has completely dried, make sure the lid fits the tray and can be easily removed. Put it back in its place on the tray. Only then carefully remove the protective covering.



# ONE SMART BOX Spirit Island® Organizer

SIOR01  
Compatible with Spirit Island® board game with All Expansions  
Assembly Guide

## Cardholder 4

Intended for Invader Cards.

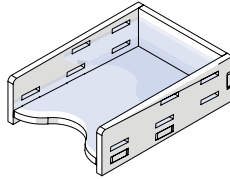

Sheets 2, 9

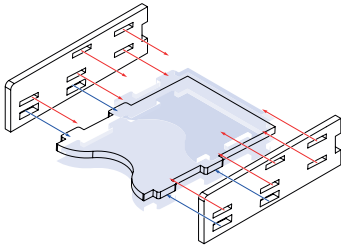
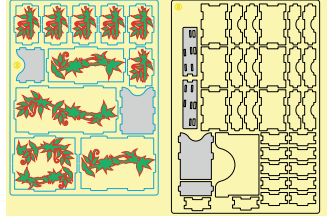

Step 1

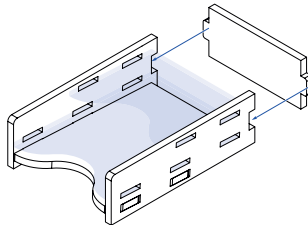

Step 2

Make sure to remove the protective covering from BOTH sides of the acrylic pieces BEFORE starting the assembly.



## ONE SMART BOX

Some other SMONEX products:  
Clans of Caledonia® Organizer COCOR01



Lords of Waterdeep® Organizer LWDOR01





ONE SMART BOX

Welcome to <https://smonex.com>.

If something is damaged or broken, please do not return the whole set. Contact us directly on email [info@smonex.com](mailto:info@smonex.com) or our website [smonex.com](https://smonex.com).

Any questions or issues with the Smonex products, we'll do our best to help you. Your satisfaction of it is our top priority.

Thanks for choosing Smonex product. We would be grateful for your feedback, which inspires us and helps to develop further. We'll gladly help you on any matter if you contact us on [info@smonex.com](mailto:info@smonex.com).

Share your photos with [#smonex](#) and follow us for all the updates:

 <https://www.facebook.com/Smonexcom>

 [https://www.instagram.com/smonex\\_com/](https://www.instagram.com/smonex_com/)

 [https://twitter.com/Smonex\\_com](https://twitter.com/Smonex_com)

 [https://www.pinterest.com/smonex/\\_shop/](https://www.pinterest.com/smonex/_shop/)

 <https://www.youtube.com/c/SmonexSmartOneBox>



Scan QR-code to visit or follow Smonex.