



# ONE SMART BOX Roll Player® Organizer

RPOR01

Compatible with Roll Player® base game with  
All Expansions and Promo Cards  
Assembly Guide



<https://smonex.com>

NOT A CHILDREN TOY

**AGE 14+**

Created for:

- Roll Player Base Game
- Roll Player: Monsters & Minion
- Roll Player: Fiends & Familiars
- Promo Cards

Roll Player® is a registered trademark of Thunderworks Games. Any mention of Roll Player® is for reference purposes only. ALL RIGHTS RESERVED by their respective trademark holders. No challenge to any intellectual property rights is intended or implied by representations of compatibility and no endorsements of any of our products by any other company is implied or represented.



# ONE SMART BOX Roll Player® Organizer

RPOR01

Compatible with Roll Player® base game with  
All Expansions and Promo Cards  
Assembly Guide

## Tips and tricks

- To assemble each tray you need a wood glue for extra strength. (We recommend Titebond 2 Wood Glue or Beacon 527).
- Please make sure you assembled each tray correctly before gluing it together.
- Use stationery knife to cut the bits that connect details to the frame.
- Remove the details from the frame with a rotational motion along the axis formed by the bits you just cut.
- Use stationery knife and sandpaper to remove all the remaining connection bits.
- Please note that the engraving must be on the outside of the boxes.
- You may fix the box with rubber bands after gluing it. This will save you time and simplify the assembly.
- Leave your finished insert overnight to dry completely.

## Assembly Supplies



Wood-glue



Stationery knife



Hammer



Cotton swab



Rubber bands

If something is damaged or broken, please do not return the whole set. Contact us directly on email [info@smonex.com](mailto:info@smonex.com) or our website [smonex.com](http://smonex.com). Any questions or issues with the Smonex products, we'll do our best to help you. We want our customers to be completely satisfied.

**IMPORTANT:** Assemble each tray one by one. Please DO NOT take out all the parts from the sheets and mix them. Even though some parts look similar, they are not interchangeable.



# ONE SMART BOX Roll Player® Organizer

RPOR01

Compatible with Roll Player® base game with  
All Expansions and Promo Cards  
Assembly Guide

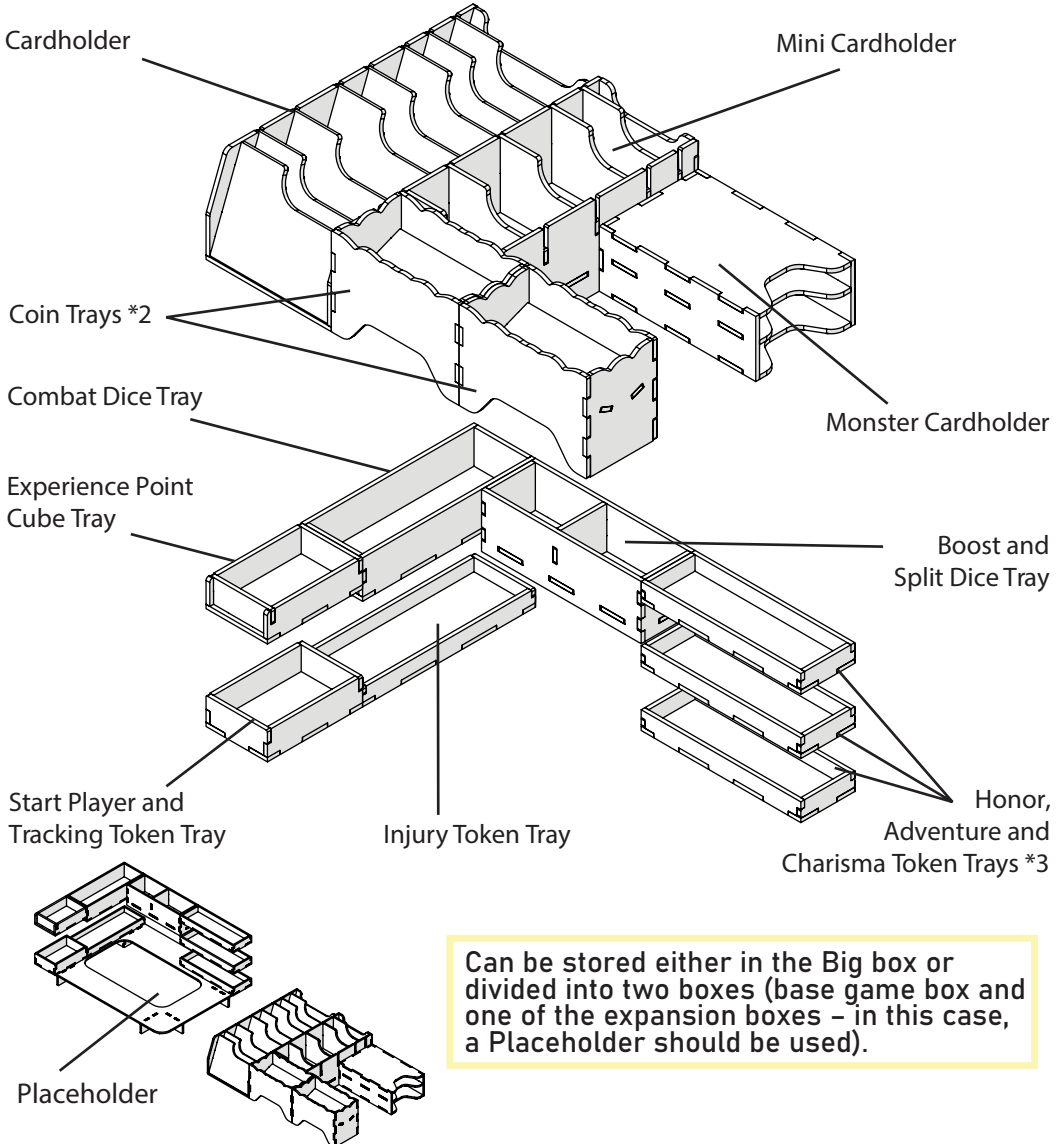

Can be stored either in the Big box or divided into two boxes (base game box and one of the expansion boxes – in this case, a Placeholder should be used).



# ONE SMART BOX Roll Player® Organizer

RPOR01

Compatible with Roll Player® base game with  
All Expansions and Promo Cards  
Assembly Guide

## Brief assembly instructions:

1. Unpack and arrange the sheets in order.
2. Compare details on the sheets with details in the pictures of the guide.
3. Study the pictures of unassembled product.
4. Start your assembly, taking the necessary parts out of the sheets in a certain order.

Sheet 1

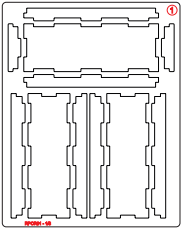

Sheet 2

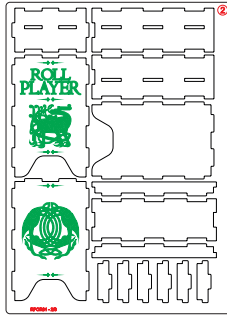

Sheet 3

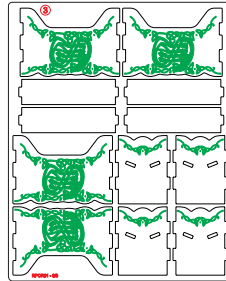

Sheet 4

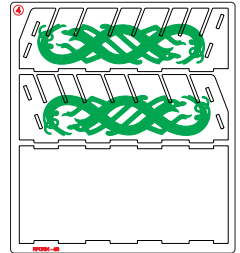

Sheet 5

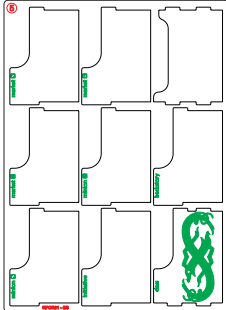

Sheet 6

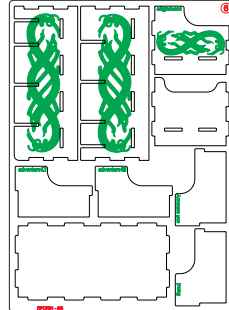



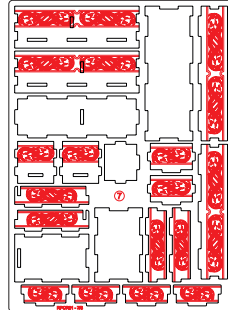

Sheet 7

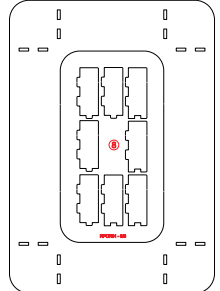

Sheet 8



## Legend:

-  Details to be extruded
-  Details not used in this assembly
-  Details to be glued
-  Details to be connected without glue

## Components:

- 8 sheets extrusion molds
- 1 sandpaper for stripping parts
- Assembly guide



# ONE SMART BOX Roll Player® Organizer

RPOR01

Compatible with Roll Player® base game with  
All Expansions and Promo Cards  
Assembly Guide

## Injury Token Tray



Intended for Injury tokens.

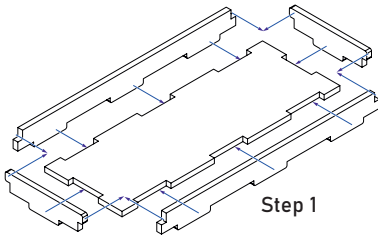
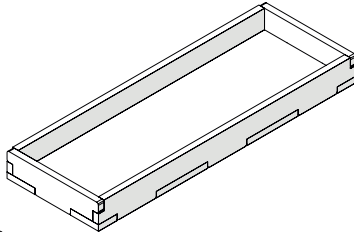

Step 1

Sheet 1

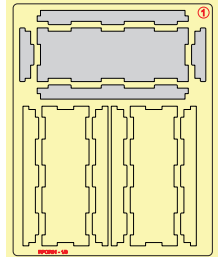

## Honor, Adventure, and Charisma Token Trays \*3



Intended for  
Honor, Adventure and  
Charisma tokens.

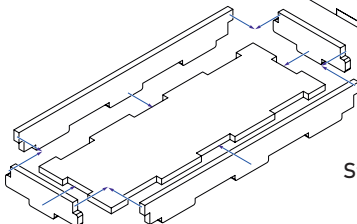
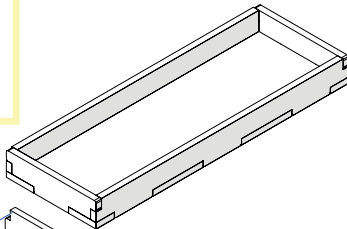

Step 1

Sheets 1, 2

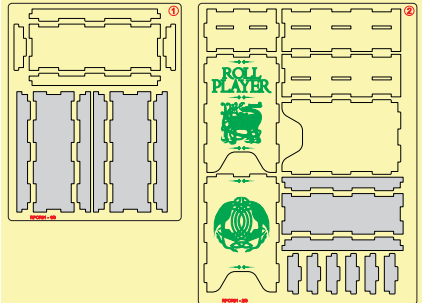



# ONE SMART BOX Roll Player® Organizer

RPOR01

Compatible with Roll Player® base game with  
All Expansions and Promo Cards  
Assembly Guide

## Monster Cardholder

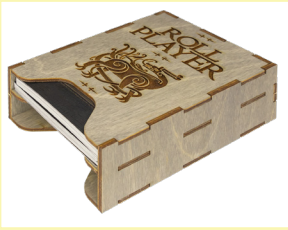

Intended for Monster cards. It will fit both the original and big-box versions of the cards.

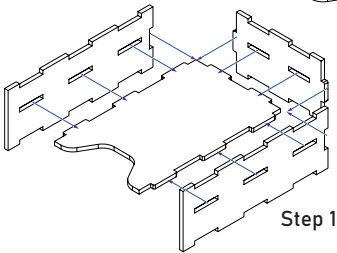

Step 1

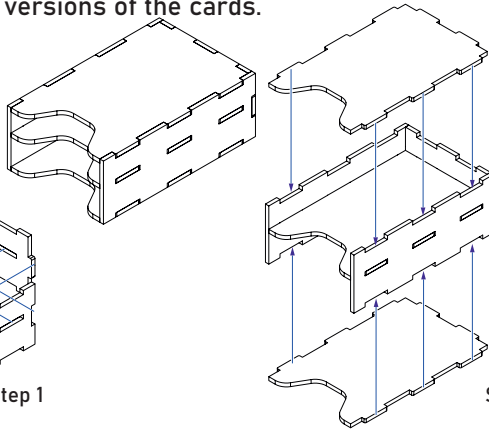

Step 2

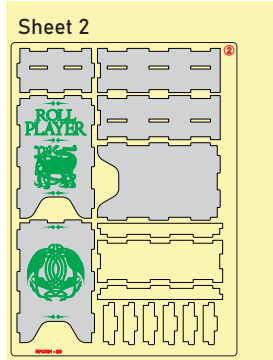

## Coin Trays \*2



Intended for Gold Coin tokens.

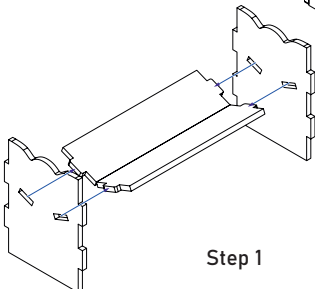

Step 1

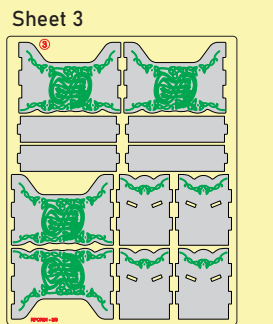
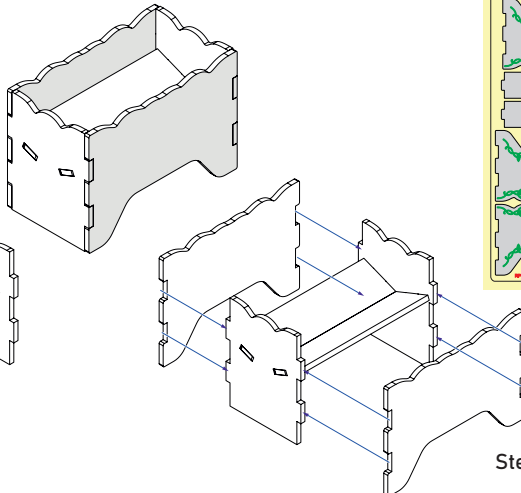



# ONE SMART BOX Roll Player® Organizer

RPOR01

Compatible with Roll Player® base game with  
All Expansions and Promo Cards  
Assembly Guide

## Cardholder



Intended for Class, Minions,  
Backstory, Initiative, and Market cards.

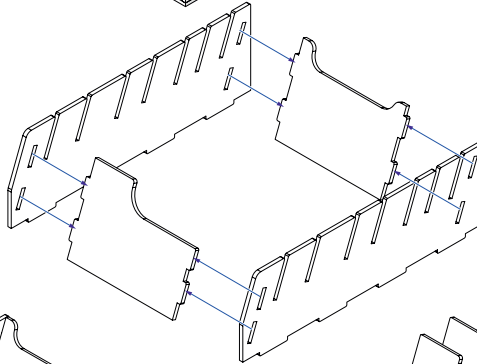
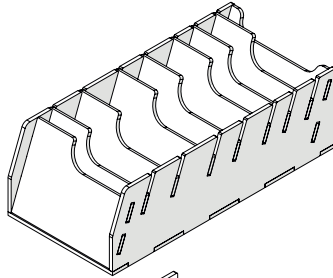

Step 1

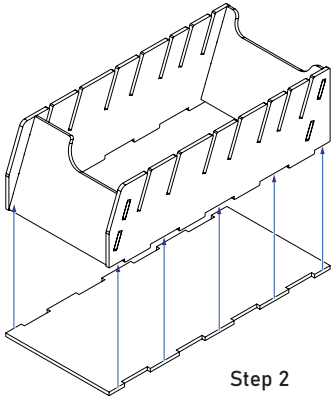

Step 2

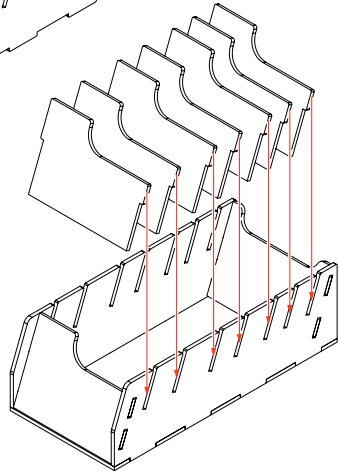

Step 3

Sheets 4, 5

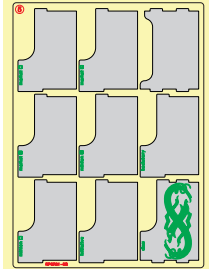
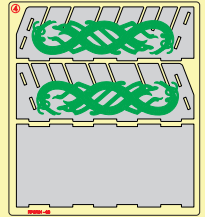





# ONE SMART BOX Roll Player® Organizer

RPOR01

Compatible with Roll Player® base game with  
All Expansions and Promo Cards  
Assembly Guide

## Mini Cardholder



Intended for Fiend, Cost Summary,  
Alignment, and Adventure cards.

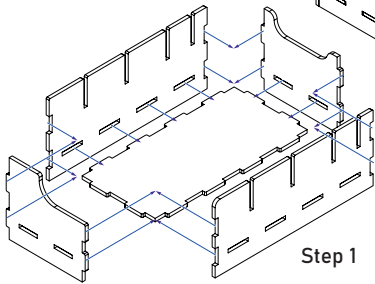
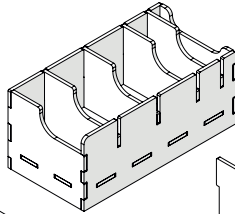

Step 1

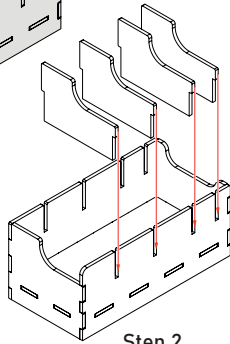

Step 2

Sheet 6

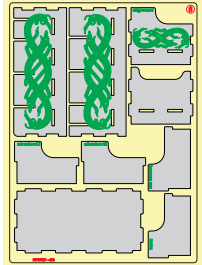

The number of dividers allows to store all the expansions cards separately. You can also reduce the number of the dividers if you prefer to store the cards from the base game and expansions together.

## Boost and Split Dice Tray



Intended for Boost and Split dice.

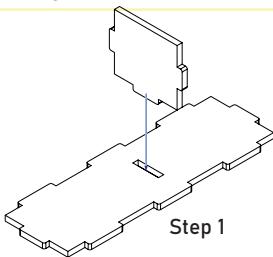
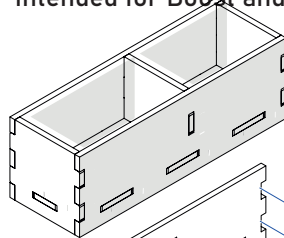

Step 1

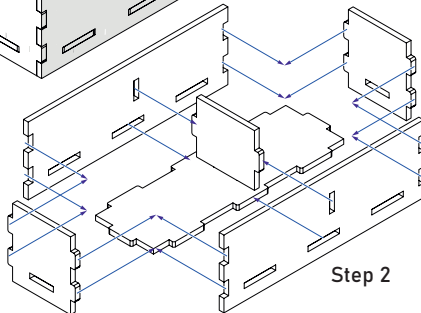

Step 2

Sheet 7

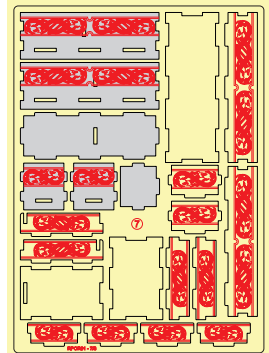





# ONE SMART BOX Roll Player® Organizer

RPOR01

Compatible with Roll Player® base game with  
All Expansions and Promo Cards  
Assembly Guide

## Combat Dice Tray



Intended for Combat dice.

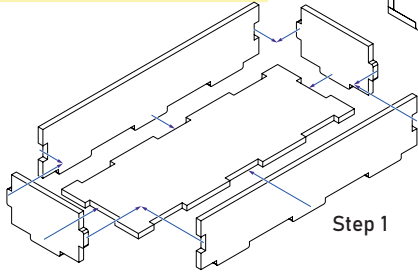
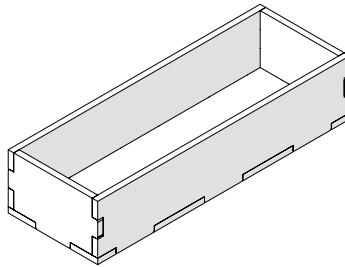

Step 1

Sheet 7

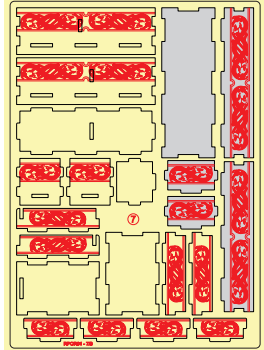

## Experience Point Cube Tray



Intended for Experience Point cubes.

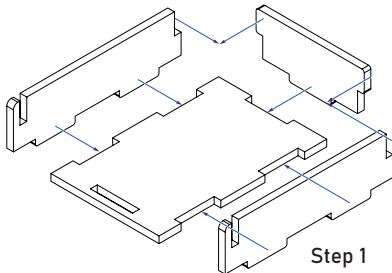
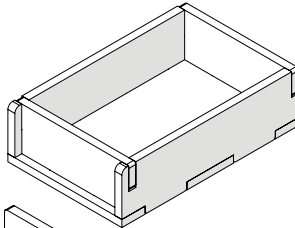

Step 1

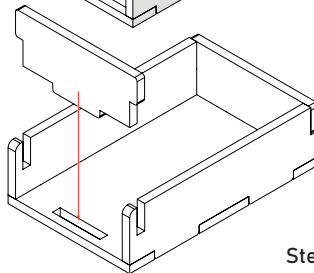

Step 2

Sheet 7

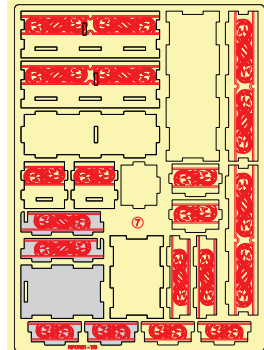



# ONE SMART BOX Roll Player® Organizer

RPOR01

Compatible with Roll Player® base game with  
All Expansions and Promo Cards  
Assembly Guide

## Start Player and Tracking Token Tray

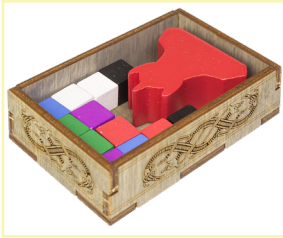

Intended for Start Player and Tracking tokens.

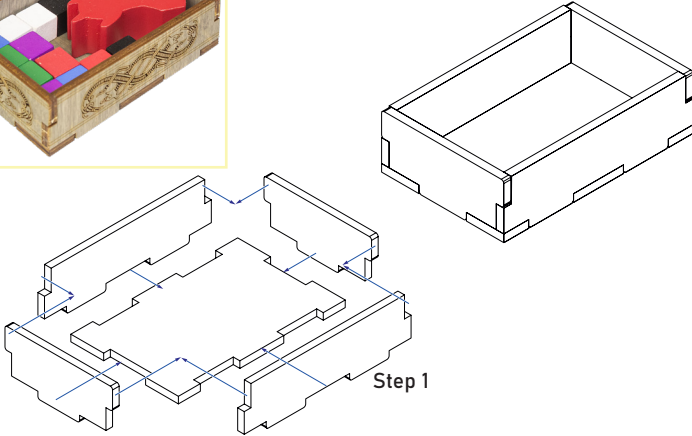

Sheet 7

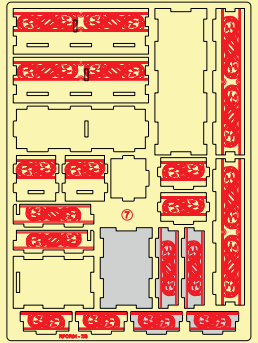

## Placeholder

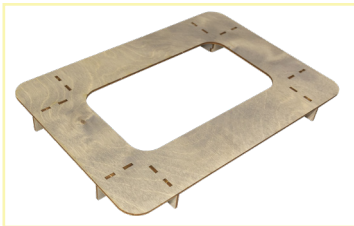

Intended for filling the free space in case you store the game in two boxes.

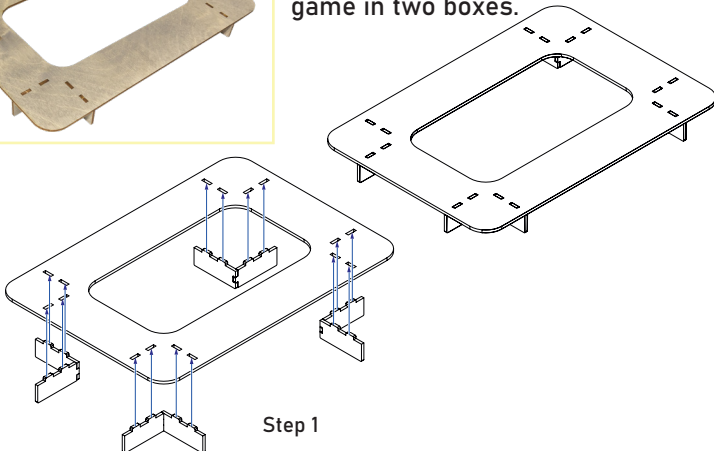

Sheet 8

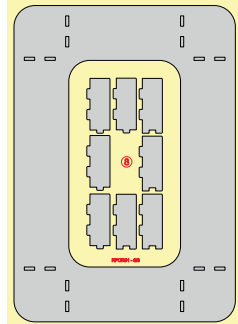



## ONE SMART BOX

Some other SMONEX products:  
Troyes<sup>®</sup> Organizer TRSOR01



Spirit Island<sup>®</sup> Organizer SIOR01





ONE SMART BOX

Welcome to <https://smonex.com>.

If something is damaged or broken, please do not return the whole set. Contact us directly on email [info@smonex.com](mailto:info@smonex.com) or our website [smonex.com](https://smonex.com).

Any questions or issues with the Smonex products, we'll do our best to help you. Your satisfaction of it is our top priority.

Thanks for choosing Smonex product. We would be grateful for your feedback, which inspires us and helps to develop further. We'll gladly help you on any matter if you contact us on [info@smonex.com](mailto:info@smonex.com).

Share your photos with **#smonex** and follow us for all the updates:



<https://www.facebook.com/Smonexcom>

[https://www.instagram.com/smonex\\_com/](https://www.instagram.com/smonex_com/)

[https://twitter.com/Smonex\\_com](https://twitter.com/Smonex_com)

[https://www.pinterest.com/smonex/\\_shop/](https://www.pinterest.com/smonex/_shop/)

<https://www.youtube.com/c/SmonexSmartOneBox>



Scan QR-code to visit or follow Smonex.