



ONE SMART BOX

# Merchants Cove® Organizer

## MCOR01

Compatible with Merchants Cove® board game  
with The Dragon Rancher, The Innkeeper, The Oracle  
and The Secret Stash expansions

### Assembly Guide

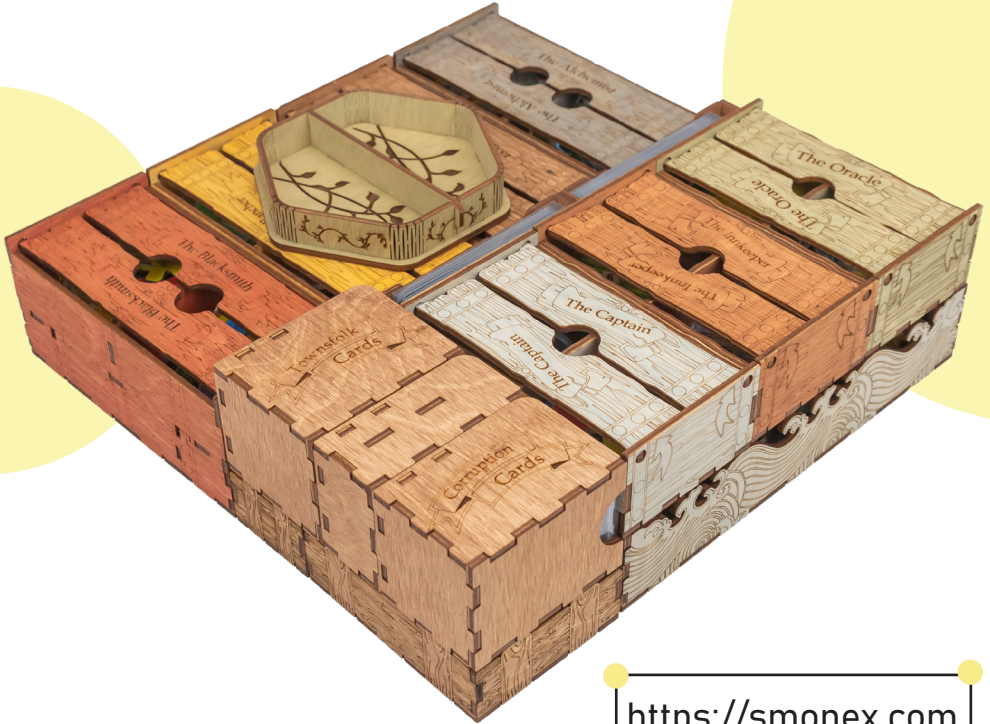

<https://smonex.com>

#### Created for:

- Merchants Cove Base Game
- Merchants Cove: The Dragon Rancher
- Merchants Cove: The Innkeeper
- Merchants Cove: The Oracle
- Merchants Cove: The Secret Stash

NOT A CHILDREN TOY  
**AGE 14+**

Merchants Cove® is a registered trademark of Final Frontier Games. Any mention of Merchants Cove® is for reference purposes only. ALL RIGHTS RESERVED by their respective trademark holders. No challenge to any intellectual property rights is intended or implied by representations of compatibility and no endorsements of any of our products by any other company is implied or represented.



ONE SMART BOX

# Merchants Cove® Organizer

## MCOR01

Compatible with Merchants Cove® board game with The Dragon Rancher, The Innkeeper, The Oracle and The Secret Stash expansions

### Assembly Guide

#### Tips and tricks

- To assemble each tray you need a wood glue for extra strength. (We recommend Titebond 2 Wood Glue or Beacon 527).
- Please make sure you assembled each tray correctly before gluing it together.
- Use stationery knife to cut the bits that connect details to the frame.
- Remove the details from the frame with a rotational motion along the axis formed by the bits you just cut.
- Use stationery knife and sandpaper to remove all the remaining connection bits.
- Please note that the engraving must be on the outside of the boxes.
- You may fix the box with rubber bands after gluing it. This will save you time and simplify the assembly.
- Make sure to remove the protective covering from BOTH sides of the acrylic pieces. Use a hairdryer for easier removal of it if necessary. Just heat the acrylic surface a little to remove the covering much easier!
- Leave your finished insert overnight to dry completely.

#### Assembly Supplies



Wood-glue



Stationery knife



Hammer



Cotton swab



Rubber bands



Hairdryer

If something is damaged or broken, please do not return the whole set. Contact us directly on email [info@smonex.com](mailto:info@smonex.com) or our website [smonex.com](http://smonex.com). Any questions or issues with the Smonex products, we'll do our best to help you. We want our customers to be completely satisfied.

**IMPORTANT:** Assemble each tray one by one. Please DO NOT take out all the parts from the sheets and mix them. Even though some parts look similar, they are not interchangeable.



ONE SMART BOX

# Merchants Cove® Organizer

MCOR01

Compatible with Merchants Cove® board game with The Dragon Rancher, The Innkeeper, The Oracle and The Secret Stash expansions  
Assembly Guide

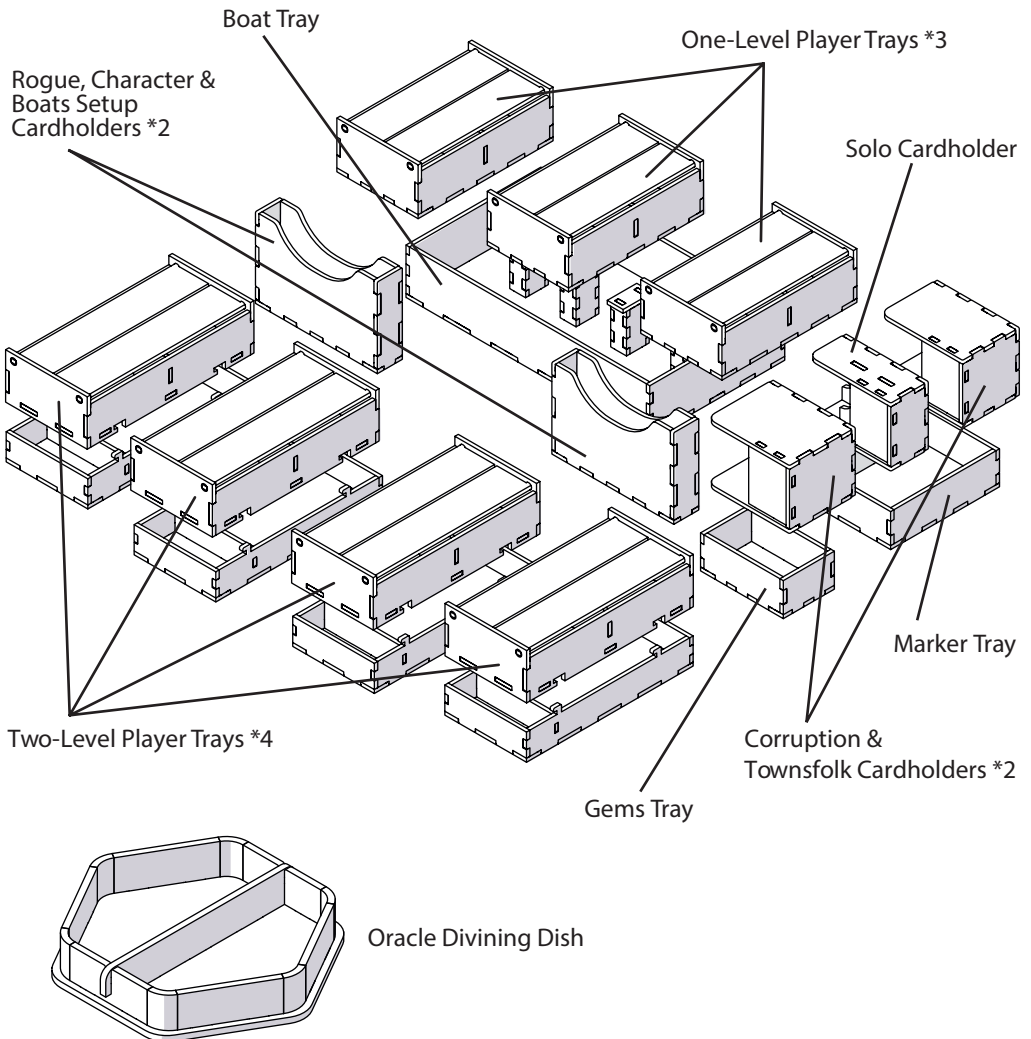



ONE SMART BOX

# Merchants Cove® Organizer

MCOR01



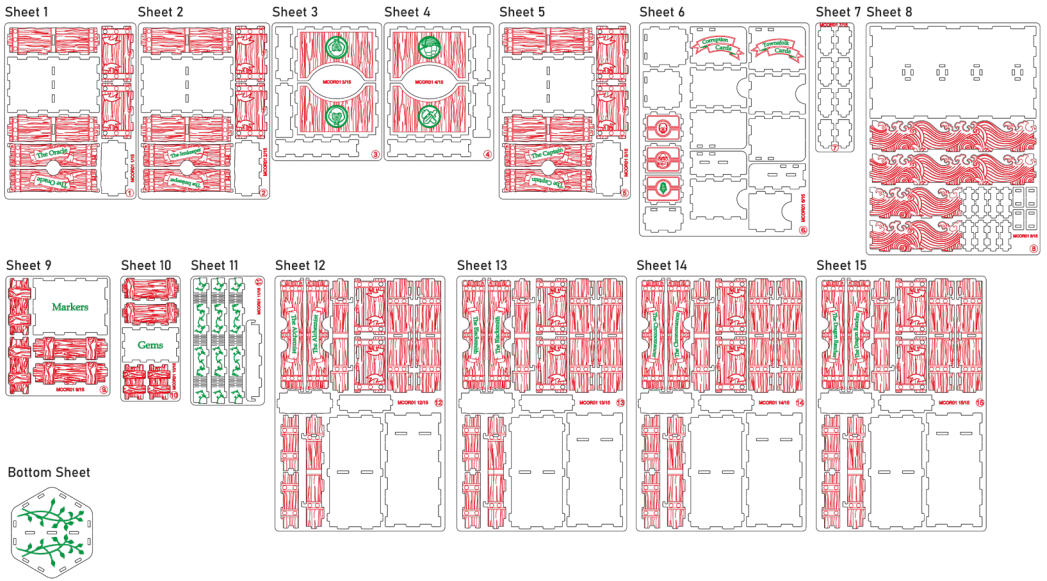

Compatible with Merchants Cove® board game with The Dragon Rancher, The Innkeeper, The Oracle and The Secret Stash expansions  
**Assembly Guide**

**Brief assembly instructions:**

1. Unpack and arrange the sheets in order.
2. Compare details on the sheets with details in the pictures of the guide.
3. Study the pictures of unassembled product.
4. Start your assembly, taking the necessary parts out of the sheets in a certain order.



**Legend:**

-  Details to be extruded
-  Details not used in this assembly
-  Details to be glued
-  Details to be connected without glue

**Components:**

- 15 sheets extrusion molds
- 1 bottom sheet
- 1 sandpaper for stripping parts
- Assembly guide



ONE SMART BOX

# Merchants Cove® Organizer

MCOR01

Compatible with Merchants Cove® board game with The Dragon Rancher, The Innkeeper, The Oracle and The Secret Stash expansions  
Assembly Guide

## One-Level Player Trays \*3 (The Oracle, The Innkeeper, The Captain)



The Oracle: Intended for the Oracle figure, goods, and runes.  
The Innkeeper: Intended for the Innkeeper figure and goods.  
The Captain: Intended for the Captain figure, goods, and 4 plastic ships.

Sheets 1, 2, 5

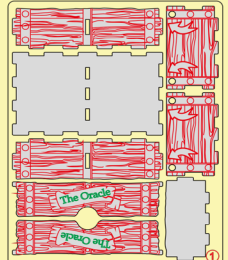

One-Level Player tray 1

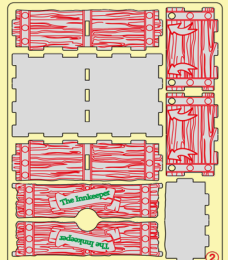

One-Level Player tray 2

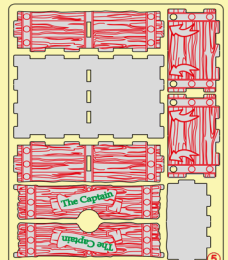

One-Level Player tray 3

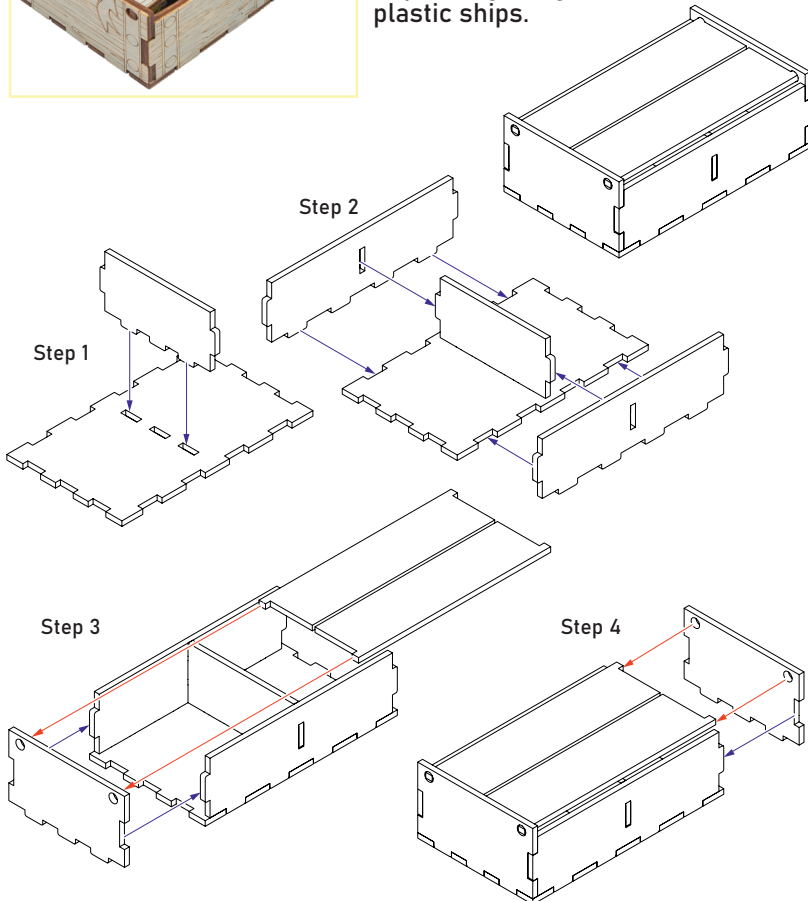



ONE SMART BOX

# Merchants Cove® Organizer

MCOR01

Compatible with Merchants Cove® board game with The Dragon Rancher, The Innkeeper, The Oracle and The Secret Stash expansions  
Assembly Guide

## Rogue, Character and Boats Setup Cardholders \*2



Intended for Rogue, Character, and Boats Setup cards.

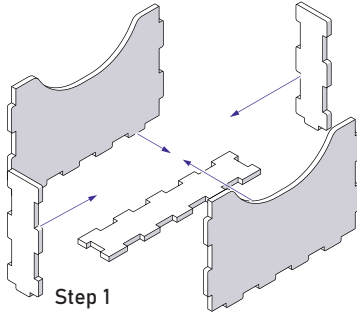

Sheets 3, 4

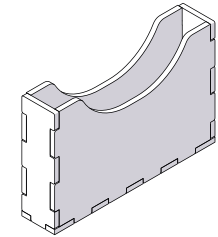
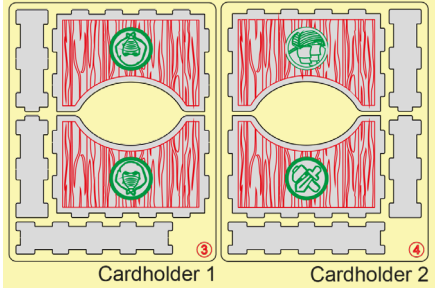

## Conflict Cardholder



Intended for Corruption and Townfolk cards.

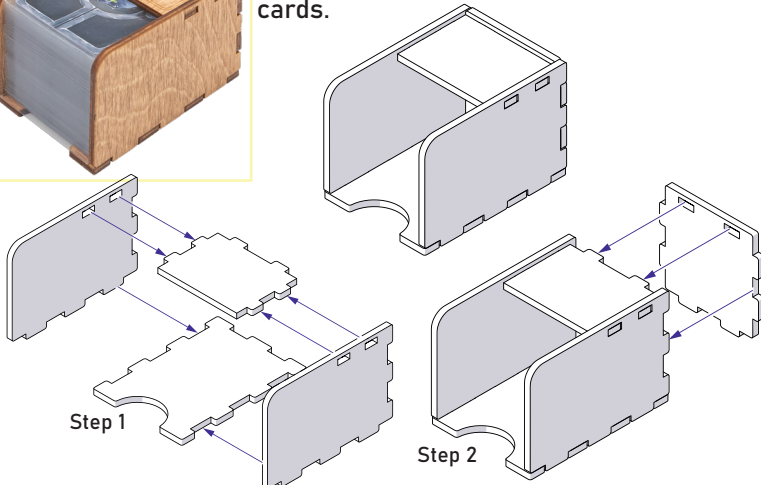

Sheet 6

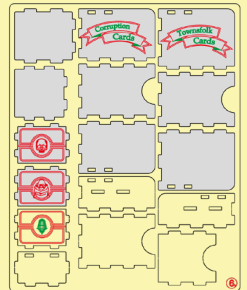



ONE SMART BOX

# Merchants Cove® Organizer

MCOR01

Compatible with Merchants Cove® board game with The Dragon Rancher, The Innkeeper, The Oracle and The Secret Stash expansions

## Solo Cardholder



Intended for Solo Mode Peddler cards.

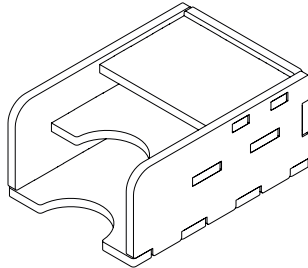

Sheet 6

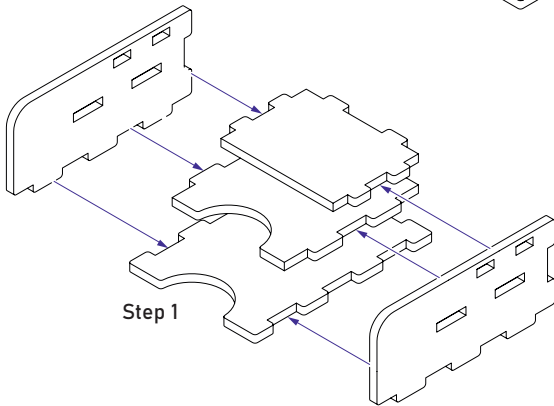
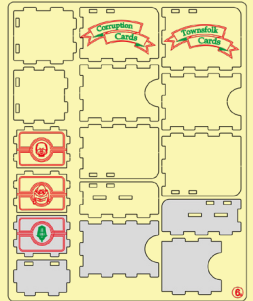

Step 1

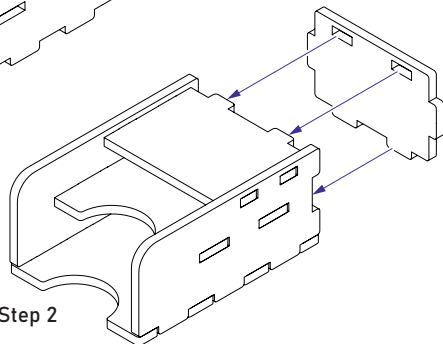

Step 2



ONE SMART BOX

# Merchants Cove® Organizer

MCOR01

Compatible with Merchants Cove® board game with The Dragon Rancher, The Innkeeper, The Oracle and The Secret Stash expansions  
Assembly Guide

## Boat Tray

Intended for boats.

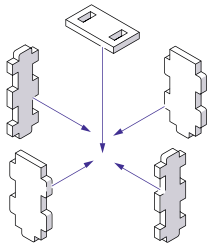
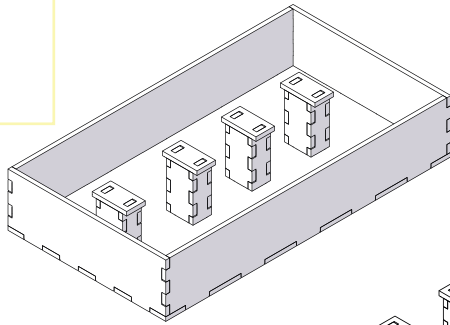
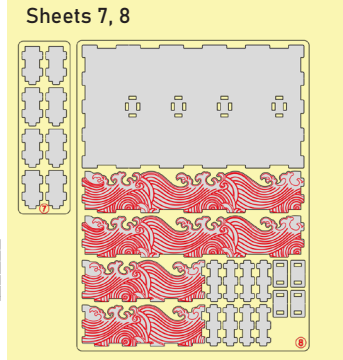
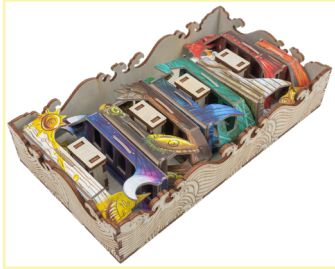

Step 1

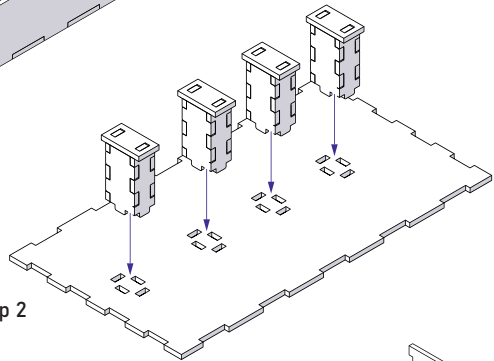
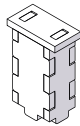

Step 2

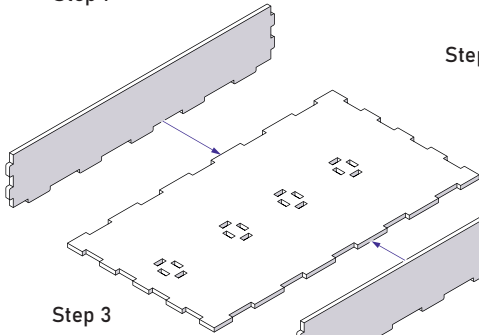

Step 3

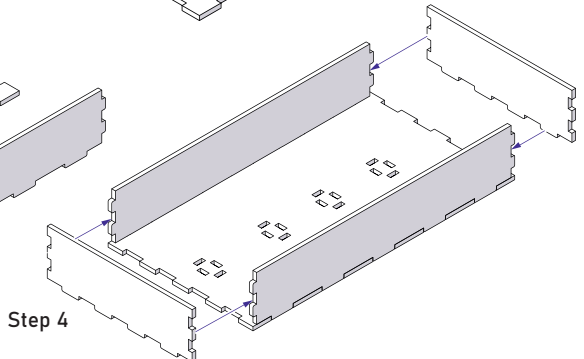

Step 4





ONE SMART BOX

# Merchants Cove® Organizer

MCOR01

Compatible with Merchants Cove® board game with The Dragon Rancher, The Innkeeper, The Oracle and The Secret Stash expansions  
Assembly Guide



## Marker Tray

Intended for Merchant banners, wooden Mice, wooden Market Phase indicator, Gold trackers, Timepieces, and grey Roguesk.

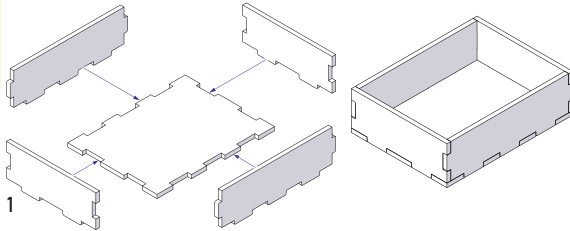

Sheet 9

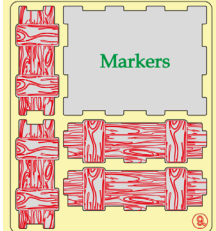

## Gems Tray

Intended for Rock Rose gems.

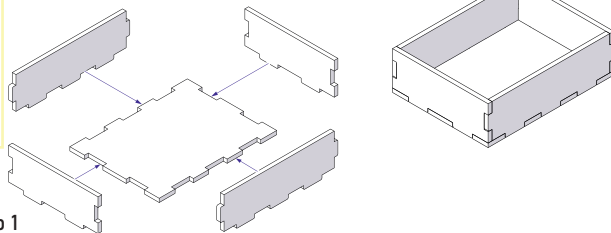

Sheet 10

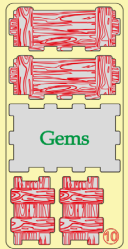

## Resource Tray

Intended for original Divining dish replacement.

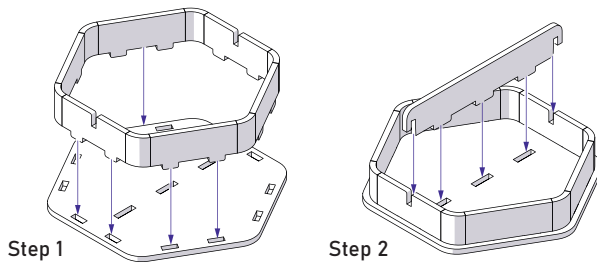
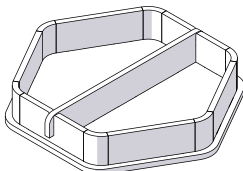

Sheet 11,  
Bottom Sheet

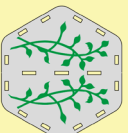
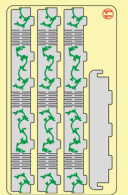



ONE SMART BOX

# Merchants Cove® Organizer

MCOR01

Compatible with Merchants Cove® board game with The Dragon Rancher, The Innkeeper, The Oracle and The Secret Stash expansions

## Assembly Guide

### Two-Level Player Trays \*4

Sheet 7, Acrylic Cover

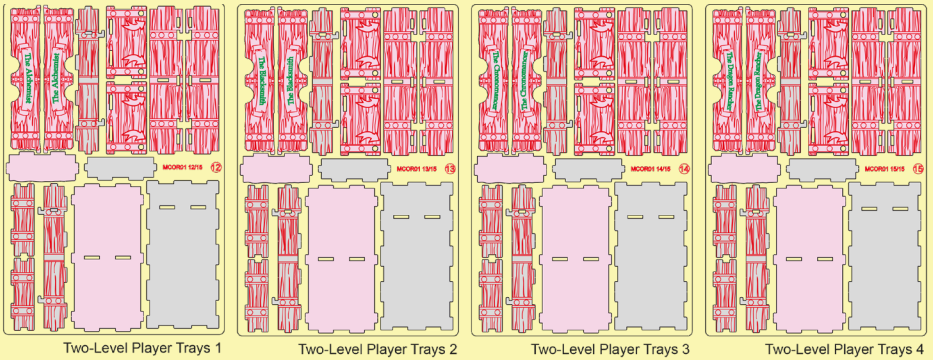

**The Alchemist:** Upper box - intended for the Alchemist goods. Lower box - intended for the Alchemist figure, Alchemy bag with ingredients, and Ichor Extracts.

**The Blacksmith:** Upper box - intended for the Blacksmith goods. Lower box - intended for the Blacksmith figure and dice.

**The Chronomancer:** Upper box - intended for the Chronomancer goods. Lower box - intended for the Chronomancer figure, Portal Fragment tiles, and Frozen Hour tokens.

**The Dragon Rancher:** Upper box - intended for the Dragon Rancher goods and Poop tokens. Lower box - intended for the Dragon Rancher figure and Feeding bag with Food discs.



### Lower box

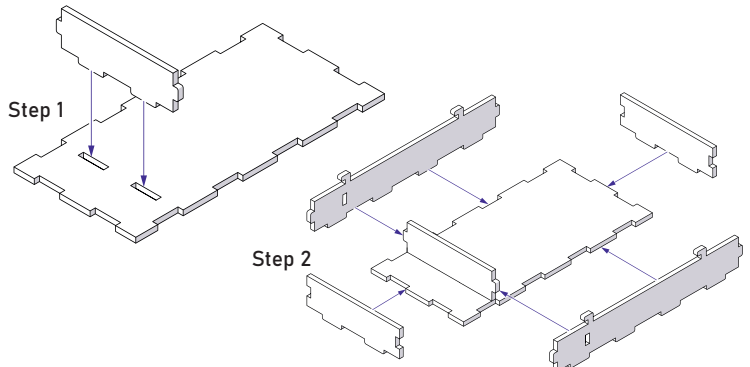
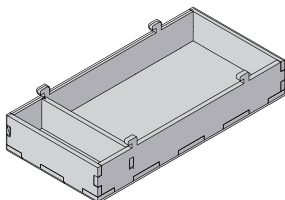



ONE SMART BOX

# Merchants Cove® Organizer

MCOR01

Compatible with Merchants Cove® board game with The Dragon Rancher, The Innkeeper, The Oracle and The Secret Stash expansions

## Assembly Guide

### Two-Level Player Trays \*4



#### Upper box

Step 1

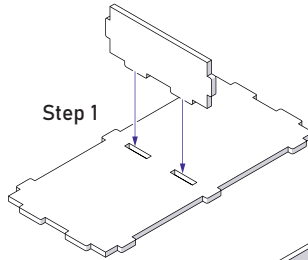

Step 2

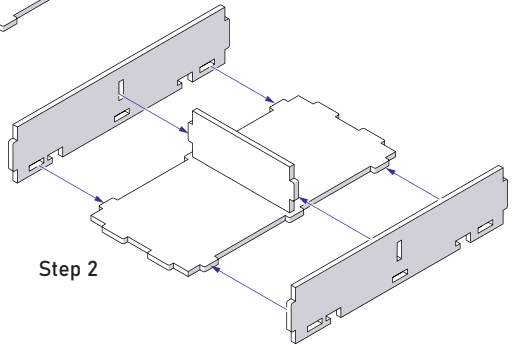

Step 3

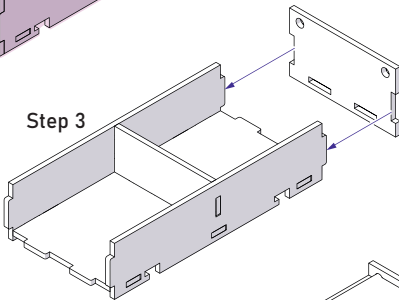

Step 4

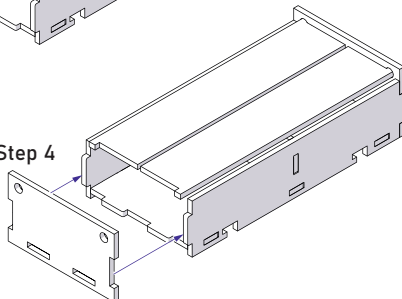

Step 5

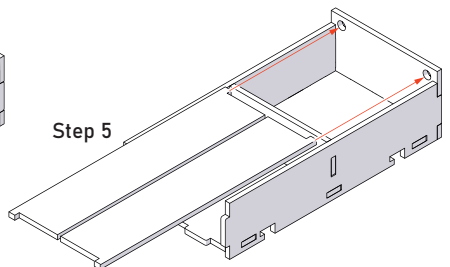



## ONE SMART BOX

Some other SMONEX products:

Splendor® Organizer SROR01

Istanbul® Organizer ILOR01







Welcome to <https://smonex.com>.

If something is damaged or broken, please do not return the whole set. Contact us directly on email [info@smonex.com](mailto:info@smonex.com) or our website [smonex.com](https://smonex.com). Any questions or issues with the Smonex products, we'll do our best to help you. Your satisfaction of it is our top priority.

Thanks for choosing Smonex product. We would be grateful for your feedback, which inspires us and helps to develop further. We'll gladly help you on any matter if you contact us on [info@smonex.com](mailto:info@smonex.com).

Share your photos with **#smonex** and follow us for all the updates:

-  <https://www.facebook.com/Smonexcom>
-  [https://www.instagram.com/smonex\\_com/](https://www.instagram.com/smonex_com/)
-  [https://twitter.com/Smonex\\_com](https://twitter.com/Smonex_com)
-  [https://www.pinterest.com/smonex/\\_shop/](https://www.pinterest.com/smonex/_shop/)
-  <https://www.youtube.com/c/SmonexSmartOneBox>



Scan QR-code to visit or follow Smonex.